

AP-270-MNT-H2 Mounting Kit

Installation Guide



The AP-270-MNT-H2 mounting kit supports multiple access point (AP) models. All installation images show the 277 AP.

Package Content

- AP-270-MNT-H2 Mounting Bracket x 1
- M6x20 Screws x 2
- Installation Guide (this document)

Installation

1. Use the AP-270-MNT-H2 as the template to mark the four mounting points on the wall.
2. Use a drill to make four holes on the four markings from the previous step.
3. Insert an anchor bolt (not included in the package) into each drilled hole.
4. Place the mounting bracket over the anchor bolts and press the bracket against the wall.
5. Place the washers and nut onto the bolt's threaded end and tighten the nut until the mounting bracket is firmly attached to the wall.

Figure 1 *Attaching the Mounting Bracket to a Wall*

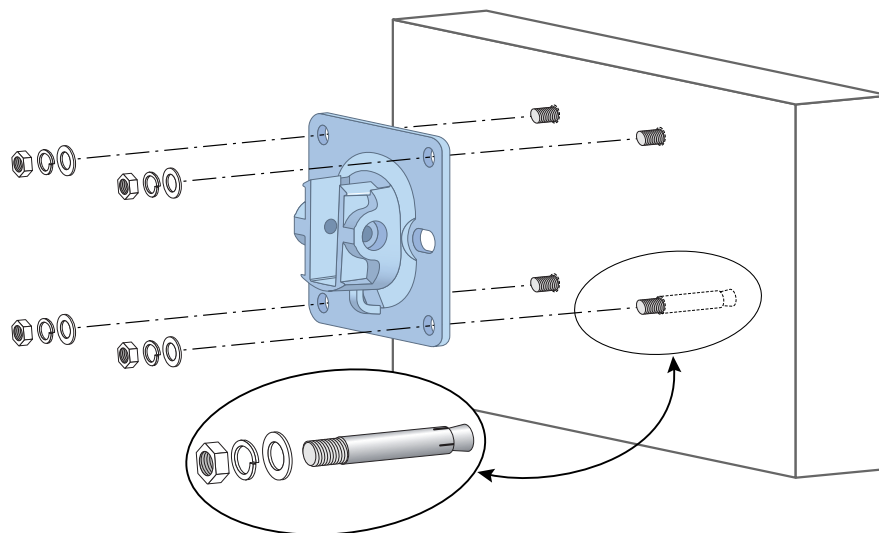

- Slide the holder of the AP into the opening of the mounting bracket and use two M6x20 screws included in the package to fix the AP to the mounting bracket.

Figure 2 Attaching the AP to the Mounting Bracket

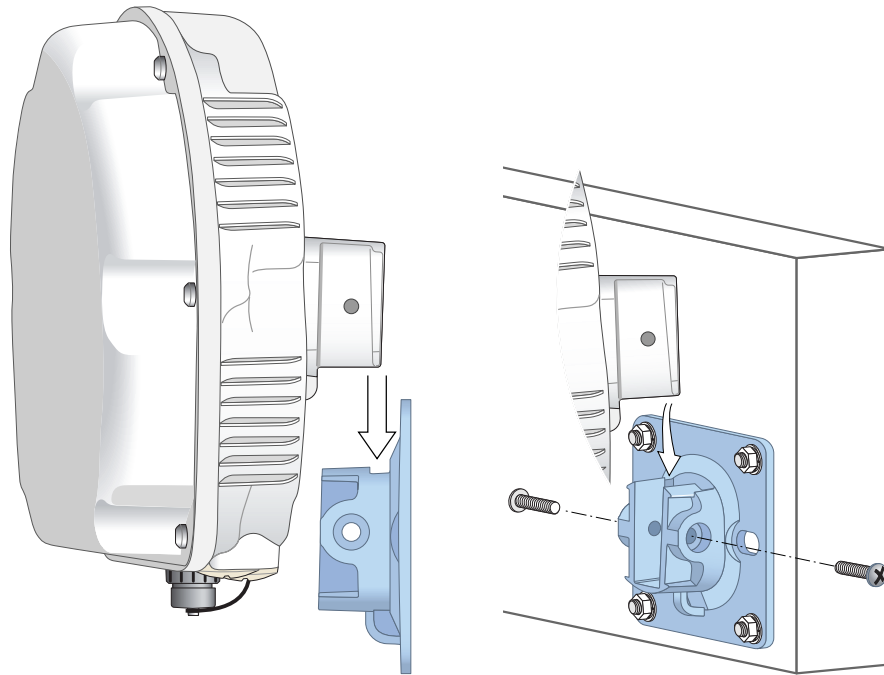
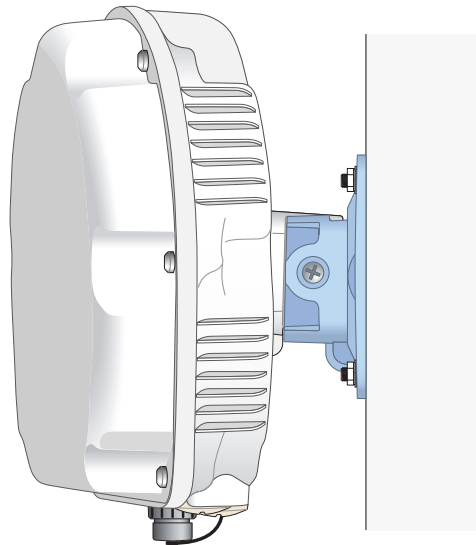

Figure 3 Attaching the AP to the Mounting Bracket (Completed)



8511782-83