



AS/NZS EMI TEST REPORT

Equipment : 360° All Around Webcam
Brand Name : j5create
Model Name : JVCU360 , JVCU360S , JVCU361S , JVCU362S
Applicant : KAIJET TECHNOLOGY INTERNATIONAL CORPORATION
8F., No.109, Zhongcheng Rd., Tucheng Dist., New Taipei City
236, Taiwan, R.O.C.
Manufacturer : Magic Control Technology Corporation
10F., No.123, Zhongcheng Rd., Tucheng Dist., New Taipei City
236, Taiwan R.O.C.
Standard : AS/NZS CISPR 32:2015 Class B

The product was received on Jul. 17, 2020, and testing was started from Jul. 20, 2020 and completed on Jul. 24, 2020. We, SPORTON INTERNATIONAL INC. EMC & Wireless Communications Laboratory, would like to declare that the tested sample has been evaluated in accordance with the procedures given in AS/NZS CISPR 32:2015 and shown compliance with the applicable technical standards.

The test results in this report apply exclusively to the tested model / sample. Without written approval of SPORTON INTERNATIONAL INC. EMC & Wireless Communications Laboratory, the test report shall not be reproduced except in full.

Approved by: William Li

SPORTON INTERNATIONAL INC. EMC & Wireless Communications Laboratory
No. 52, Huaya 1st Rd., Guishan Dist., Taoyuan City, Taiwan (R.O.C.)



Table of Contents

History of this test report	3
Summary of Test Result	4
1. General Description of Equipment under Test	5
1.1. Basic Description of Equipment under Test.....	5
1.2. Feature of Equipment under Test.....	5
1.3. Table for Multiple Listing.....	5
2. Test Configuration of Equipment under Test	6
2.1. Details of EUT Test Modes.....	6
2.2. Description of Test System.....	6
2.3. Connection Diagram of Test System.....	7
2.4. Test Manner.....	9
3. General Information of Test	10
3.1. Test Facilities.....	10
3.2. Test Standards.....	10
3.3. Test Voltage/Frequencies.....	10
3.4. Test Distance and Frequency Range Investigated.....	10
3.5. Operating Condition.....	10
4. Conducted Emissions Measurement	11
4.1. Conducted Emissions at Powerline.....	11
5. Radiated Emission	15
5.1. Radiated Emission below 1GHz.....	15
5.2. Radiated Emission above 1GHz.....	22
6. Uncertainty of Test Site	26
6.1. Emission Test Measurement Uncertainty.....	26
7. List of Measuring Equipment Used	27
Appendix A. Test Photos	
Photographs of EUT v01	



Summary of Test Result

Report Clause	Ref Std. Clause	Test Items	Result (PASS/FAIL)	Remark
4.1	A.3	Conducted Emissions of Powerline	PASS	Under limit 4.87 dB at 0.65 MHz
-	A.3	Conducted Emissions of telecommunication Ports	Not Applicable	Note 1
5.1	A.2	Radiated Emissions below 1GHz	PASS	Under limit 4.75 dB at 178.260 MHz
5.2	A.2	Radiated Emissions above 1GHz	PASS	Under limit 25.15 dB at 5.915 GHz

Note 1: This EUT without telecommunication ports, it's not necessary to apply to Telecom Port Conducted emission test.

Note 2: From Sporton Project No.:AI071608.

Declaration of Conformity:

The test results with all measurement uncertainty excluded are presented in accordance with the regulation limits or requirements declared by manufacturers.

Comments and explanations:

None

Reviewed by: Andrew Yang

Report Producer: Michelle Tsai



1. General Description of Equipment under Test

1.1. Basic Description of Equipment under Test

Equipment : 360° All Around WEBCAM
Model No. : JVCU360 , JVCU360S , JVCU361S , JVCU362S
Power Supply Type : From Host system
The maximum operating frequency : 480MHz

1.2. Feature of Equipment under Test

For a more detailed features description, please refer to the manufacturer's specifications or the User's Manual.

1.3. Table for Multiple Listing

Model Name	Description
JVCU360	The difference of models is in sales marketing.
JVCU360S	
JVCU361S	
JVCU362S	

Note: The information from manufacturer.



2. Test Configuration of Equipment under Test

2.1. Details of EUT Test Modes

From the above models, Model: JVCU360S was selected as representative model for the test and its data was recorded in this report. The equipment under test were performed the following test modes:

Test Items	Description of test modes
Conducted Emission	Mode 1. TYPE A,SYSTEM ON Mode 2. TYPE C,SYSTEM ON cause "mode 1" generated the worst test result; it was reported as final data.
Radiated Emissions <below 1GHz>	Mode 1. TYPE A,SYSTEM ON Mode 2. TYPE C,SYSTEM ON cause "mode 1" generated the worst test result; it was reported as final data.
Radiated Emissions <above 1GHz>	Mode 1. TYPE A,SYSTEM ON

2.2. Description of Test System

Conducted emission and radiated emission below 1GHz

No.	Peripheral	Manufacturer	Model Number	FCC ID	Remarks
For Local					
A	Notebook	DELL	P54G	DoC	-
B	Notebook Adapter	DELL	LA45NM131	DoC	-
C	Mouse	ASUS	MOBTUO	DoC	-
D	Portable External HDD	AKITION	SK2-U31AS-AKT	DoC	-

Radiated emission above 1GHz

No.	Peripheral	Manufacturer	Model Number	FCC ID	Remarks
For Local					
A	Notebook	DELL	P54G	DoC	-
B	Notebook Adapter	DELL	LA45NM131	DoC	-
C	Mouse	Microsoft	1113	DoC	-
D	Portable External HDD	AKITION	SK2-U31AS-AKT	DoC	-

2.3. Connection Diagram of Test System

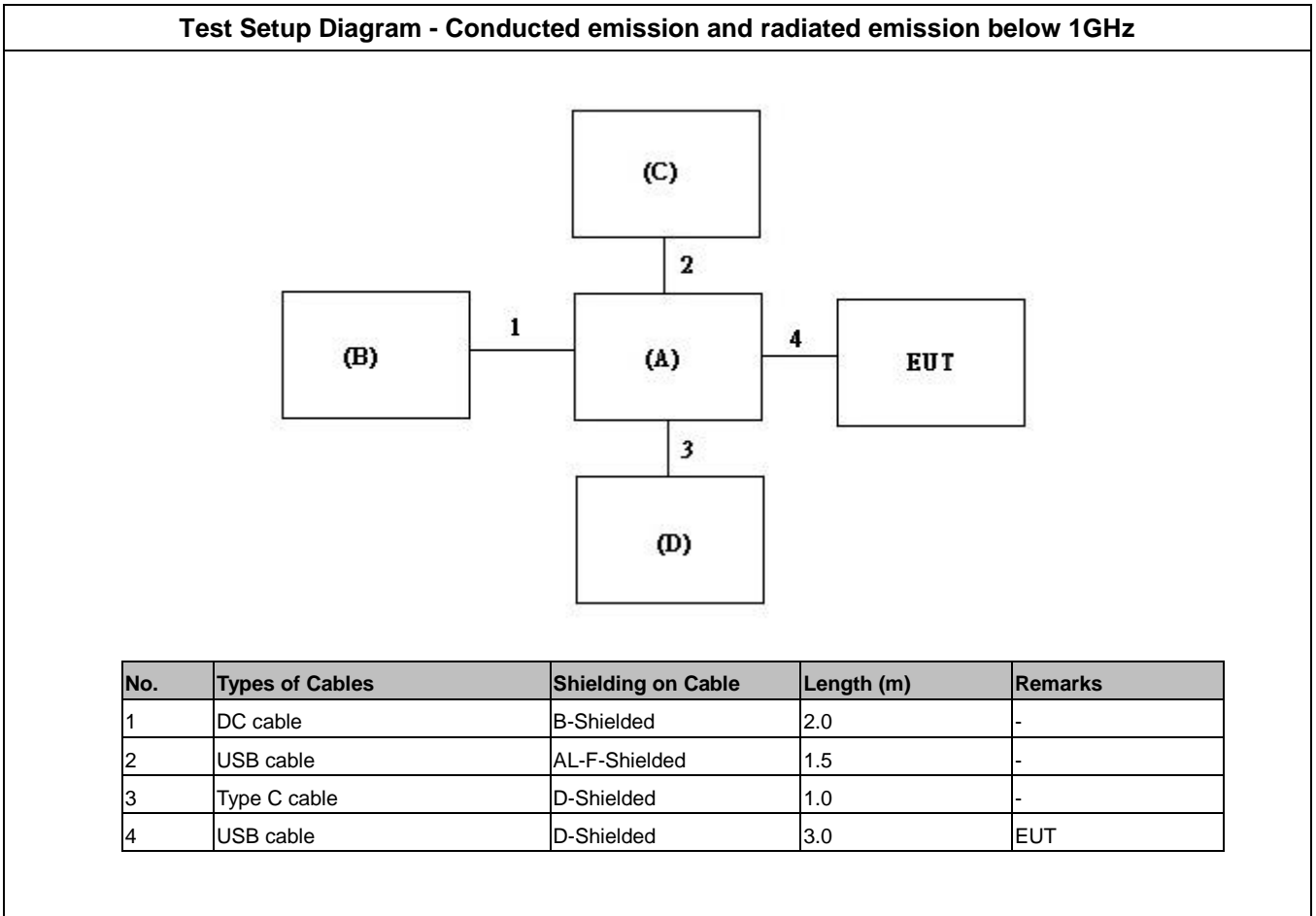

Test Setup Diagram - Radiated emission above 1GHz

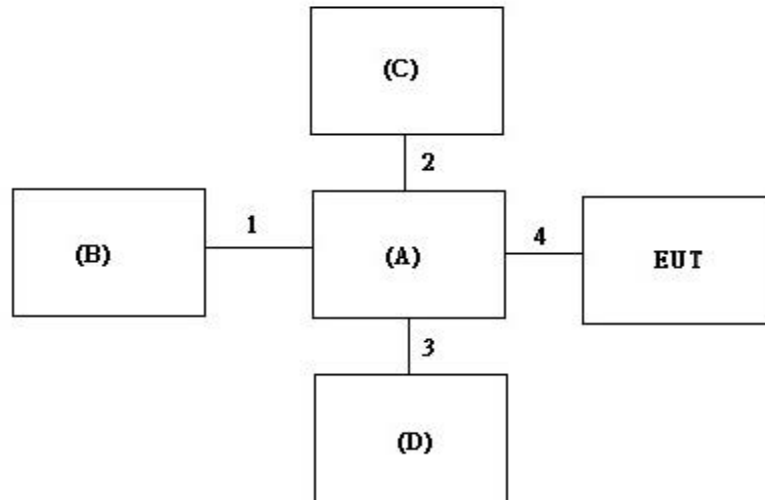

No.	Types of Cables	Shielding on Cable	Length (m)	Remarks
1	DC cable	B-Shielded	2.0	-
2	USB cable	AL-F-Shielded	1.8	-
3	Type C cable	D-Shielded	0.4	-
4	USB cable	D-Shielded	3.0	EUT



2.4. Test Manner

An executive program, "EMIprogram.exe" under WIN 10 was used as the test software. The program was executed as follows:

- Turn on the power of all equipment.
- The Notebook executed "1729 MPEG4" to keep displaying the Standard television color bar signal (ITU-R BT 1729).
- The Notebook executed "BurnInTest" to read and write data from HDD.
- The Notebook executed "camera" to preview the image by EUT.
- The Notebook executed "voice recorder" to record the audio signal via mic by EUT.



3. General Information of Test

3.1. Test Facilities

Test Site : SPORTON INTERNATIONAL INC.						
<input checked="" type="checkbox"/>	HUA YA	ADD : No. 52, Huaya 1st Rd., Guishan Dist., Taoyuan City, Taiwan (R.O.C.) TEL : 886-3-327-3456 FAX : 886-3-318-0055				
<input checked="" type="checkbox"/>	DONG HU	ADD : No. 3, Ln. 238, Kangle St., Neihu Dist., Taipei City, Taiwan (R.O.C.) TEL : 886-2-2631-5551 FAX : 886-2-2631-9740				
<input type="checkbox"/>	LIN KOU	ADD : No. 30-2, Dingfu Vil., Linkou Dist., New Taipei City, Taiwan (R.O.C.) TEL : 886-2-2601-1640 FAX : 886-2-2601-1695				
Test Items	Test Site No.	Test Engineer	Test Environment		Test Date	Remark
			temp °C	humidity %		
Powerline Conducted Emissions	CO01-NH	Willy Lee	26.1~26.3	51.6~51.8	20/Jul/2020	-
Radiated Emissions (below 1GHz)	OS03-NH	Louis Lin	30.1~30.3	54.2~54.3	20/Jul/2020	-
Radiated Emissions (above 1GHz)	03CH04-HY	Yen-Liang Ou	26.5~27.5	57~58	24/Jul/2020	-

3.2. Test Standards

Test items	Test Standards and Test Procedures
Radiated and Conducted Emissions	Australian Standard AS/NZS CISPR 32 Class B

3.3. Test Voltage/Frequencies

Power Supply Type	Voltage/Frequencies
AC Power Supply	240V / 50Hz

3.4. Test Distance and Frequency Range Investigated

Test Items	Frequency Range	Remark
Powerline Conducted Emissions	150 kHz to 30 MHz	-
Radiated Emissions (below 1GHz)	30 MHz to 1,000 MHz	Measurement distance is 10 m.
Radiated Emissions (above 1GHz)	1,000 MHz to 6,000 MHz	Measurement distance is 3 m.

3.5. Operating Condition

- Full system.



4. Conducted Emissions Measurement

The EUT is which satisfies the Class B disturbance limits.

4.1. Conducted Emissions at Powerline

4.1.1. Limit

conducted emissions from the AC mains power ports of Class A equipment			
Frequency range MHz	Coupling device	Detector type / bandwidth	Class A limits dB(µV)
0,15 – 0,5	AMN	Quasi-peak / 9 kHz	79
0,50 – 30			73
0,15 – 0,5	AMN	Average / 9 kHz	66
0,50 – 30			60

conducted emissions from the AC mains power ports of Class B equipment			
Frequency range MHz	Coupling device	Detector type / bandwidth	Class B limits dB(µV)
0,15 – 0,5	AMN	Quasi-peak / 9 kHz	66 - 56
0,5 – 5			56
5 – 30			60
0,15 – 0,5	AMN	Average / 9 kHz	56 - 46
0,5 – 5			46
5 – 30			50

Note: The limit decreases linearly with the logarithm of the frequency in the range 0.15 MHz to 0.50 MHz.

4.1.2. Test Procedures

- a). The EUT was warmed up for 15 minutes before testing started.
- b). The EUT was placed on a desk 0.8 meter height from the metal ground plane and 0.4 meter from the conducting wall of the shielding room and it was kept at least 0.8 meter from any other grounded conducting surface.
- c). Connect EUT to the power mains through a line impedance stabilization network (LISN).
- d). All the support units are connect to the other LISN.
- e). The LISN provides 50 ohm, coupling impedance for the measuring instrument.
- f). The CISPR states that a 50 ohm, 50 microhenry LISN should be used.
- g). Both sides of AC line were checked for maximum conducted interference.
- h). The frequency range from 150 kHz to 30 MHz was searched.
- i). Set the test-receiver system to Peak Detect Function and Specified Bandwidth with Maximum Hold Mode.
- j). All emissions not reported here are more than 10 dB below the prescribed limit.

4.1.3. Measurement Results Calculation

The measurand Level is calculated using:

Corrected Reading (dB μ V) = LISN Factor + Cable Loss + Read Level

For example at 0.3 MHz if the LISN Factor is 10.48 dB, the cable loss is 0.10 dB, the measured voltage is 36.39 dB μ V, the signal strength would be calculated:

Corrected Reading (dB μ V) = 10.48 dB + 0.10 dB + 36.39 dB μ V = 46.97 dB μ V

4.1.4. Typical Test Setup Layout

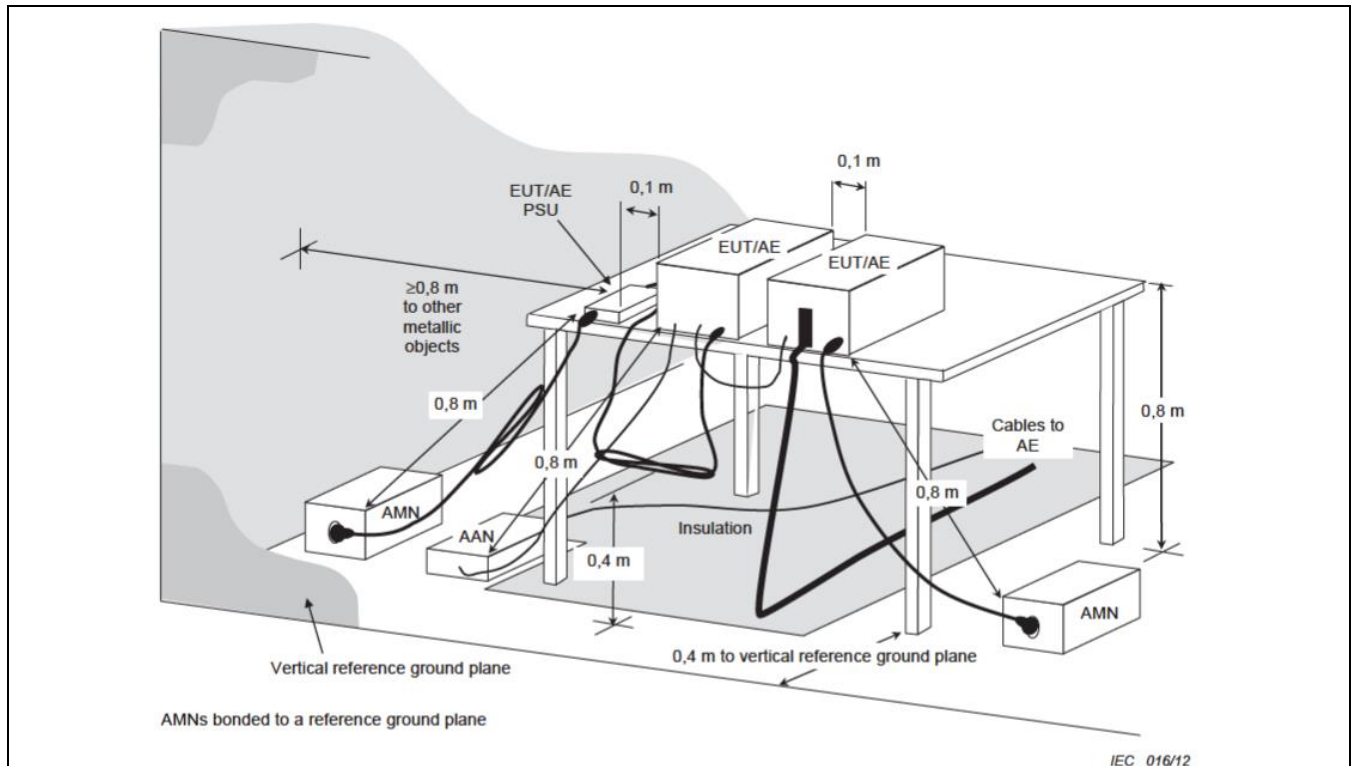

- a). AMN is 80 cm from the EUT and at least 80 cm from other units and other metal planes.
- b). EUT is connected to one artificial mains network (AMN)
- c). All other units of a system are powered from a second AMN. A multiple outlet strip can be used for multiple mains cords.
- d). Rear of EUT to be flushed with rear of table top.
- e). Peripherals shall be placed at a distance of 10 cm from each other and from the controller, except for the monitor which, if this is an acceptable installation practice, shall be placed directly on the top of the controller.
- f). If cables, which hang closer than 40 cm to the horizontal metal ground plane, cannot be shortened to appropriate length, the excess shall be folded back and forth forming a bundle 30 cm to 40 cm long.
- g). Mains cords and signal cables shall be positioned for their entire lengths, as far as possible, at 40 cm from the vertical reference plane.
- h). Cables of hand operated devices, such as keyboards, mice, etc. shall be placed as for normal usage.



4.1.5. Test Result

Test Mode	Mode 1		
Test Frequency	0.15 MHz ~ 30 MHz	Test Voltage	AC 240V / 50Hz
<p>■ The test was passed at the minimum margin that marked by the frame in the following data</p>			

Line

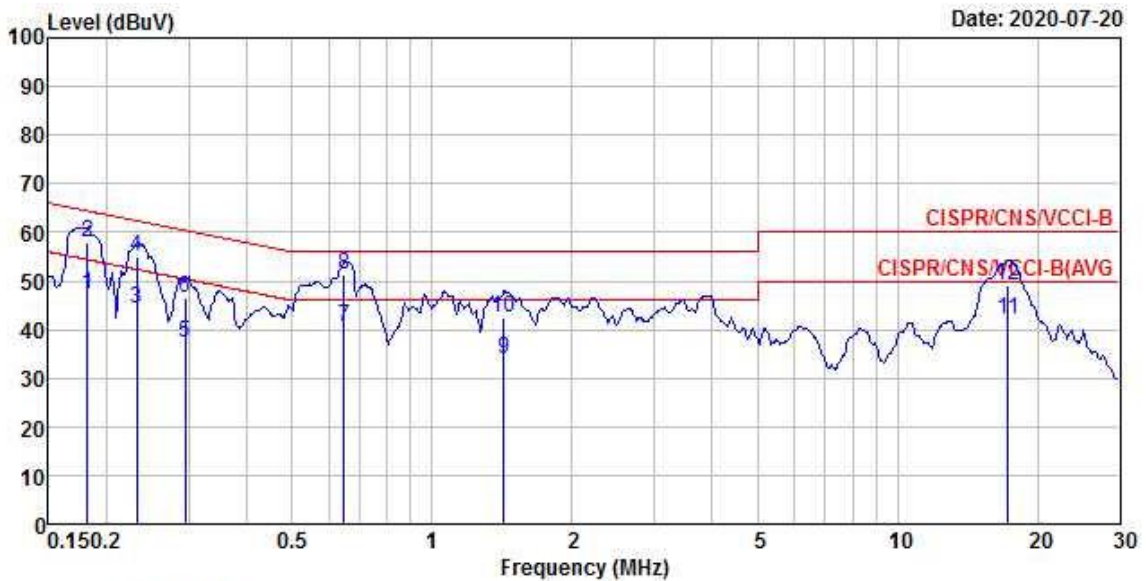

	Freq	Level	Over	Limit	Read	LISN	Cable	
	MHz	dBuV	Limit	Line	Level	Factor	Loss	Remark
			dB	dBuV	dBuV	dB	dB	
1	0.18	47.38	-7.02	54.40	36.97	10.30	0.11	Average
2	0.18	57.93	-6.47	64.40	47.52	10.30	0.11	QP
3	0.23	44.43	-7.96	52.39	34.02	10.30	0.11	Average
4	0.23	55.09	-7.30	62.39	44.68	10.30	0.11	QP
5	0.30	37.35	-13.02	50.37	26.95	10.30	0.10	Average
6	0.30	46.61	-13.76	60.37	36.21	10.30	0.10	QP
7	0.65	40.46	-5.54	46.00	30.05	10.31	0.10	Average
8 @	0.65	51.13	-4.87	56.00	40.72	10.31	0.10	QP
9	1.43	34.03	-11.97	46.00	23.60	10.32	0.11	Average
10	1.43	42.38	-13.62	56.00	31.95	10.32	0.11	QP
11	17.29	42.06	-7.94	50.00	31.01	10.60	0.45	Average
12	17.29	49.07	-10.93	60.00	38.02	10.60	0.45	QP



Neutral

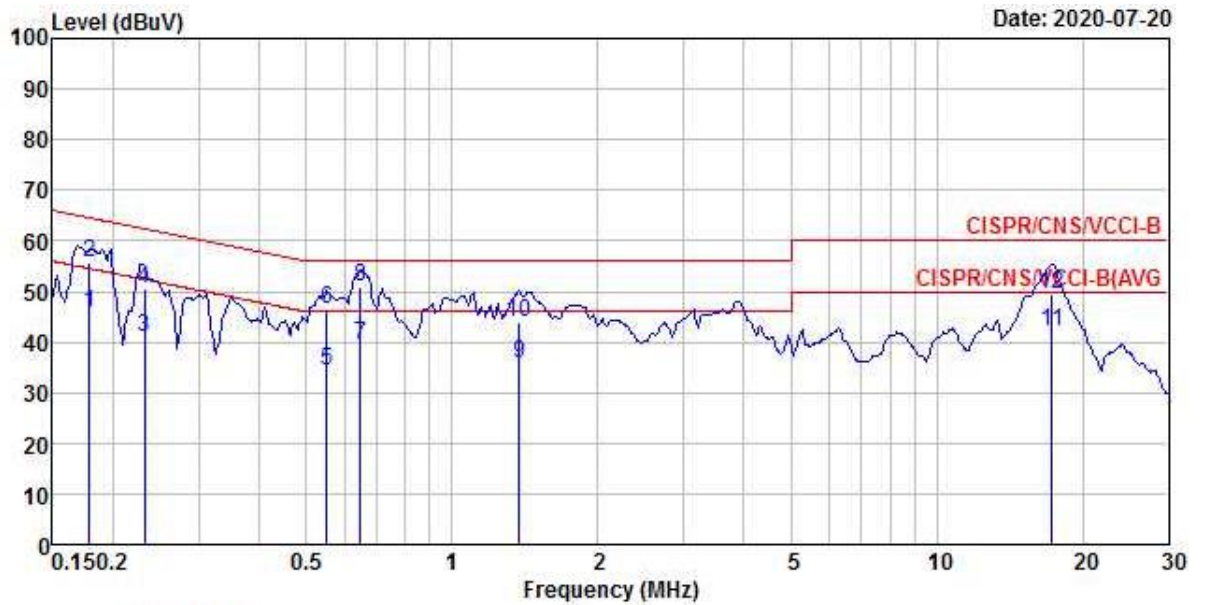

	Freq	Level	Over Limit	Limit Line	Read Level	LISN Factor	Cable Loss	Remark
	MHz	dBuV	dB	dBuV	dBuV	dB	dB	
1	0.18	45.70	-8.85	54.55	35.29	10.30	0.11	Average
2	0.18	55.62	-8.93	64.55	45.21	10.30	0.11	QP
3	0.23	40.79	-11.60	52.39	30.38	10.30	0.11	Average
4	0.23	50.42	-11.97	62.39	40.01	10.30	0.11	QP
5	0.55	34.37	-11.63	46.00	23.96	10.31	0.10	Average
6	0.55	46.36	-9.64	56.00	35.95	10.31	0.10	QP
7	0.65	39.38	-6.62	46.00	28.96	10.32	0.10	Average
8 @	0.65	50.79	-5.21	56.00	40.37	10.32	0.10	QP
9	1.37	35.72	-10.28	46.00	25.29	10.33	0.10	Average
10	1.37	44.04	-11.96	56.00	33.61	10.33	0.10	QP
11	17.29	42.24	-7.76	50.00	31.14	10.65	0.45	Average
12	17.29	49.44	-10.56	60.00	38.34	10.65	0.45	QP



5. Radiated Emission

The EUT is which satisfies the Class B disturbance limits.

5.1. Radiated Emission below 1GHz

5.1.1.Limit

radiated emissions at frequencies up to 1 GHz for Class A equipment			
Frequency range MHz	Measurement		Class A limits dB(μ V/m)
	Distance (m)	Detector type / bandwidth	OATS/SAC
30 – 230	10	Quasi Peak / 120 kHz	40
230 – 1000			47
30 – 230	3		50
230 – 1000			57

radiated emissions at frequencies up to 1 GHz for Class B equipment			
Frequency range MHz	Measurement		Class B limits dB(μ V/m)
	Distance (m)	Detector type / bandwidth	OATS/SAC
30 – 230	10	Quasi Peak / 120 kHz	30
230 – 1000			37
30 – 230	3		40
230 – 1000			47



5.1.2. Test Procedures

- a). The EUT was placed on a rotatable table top 0.8 meter above ground.
- b). The EUT was set 10 meters from the interference-receiving antenna which was mounted on the top of a variable height antenna tower.
- c). The table was rotated 360 degrees to determine the position of the highest radiation.
- d). The antenna is a half wave dipole and its height is varied between one meter and four meters above ground to find the maximum value of the field strength both horizontal polarization and vertical polarization of the antenna are set to make the measurement.
- e). For each suspected emission the EUT was arranged to its worst case and then tune the antenna tower (from 1 M to 4 M) and turn table (from 0 degree to 360 degrees) to find the maximum reading.
- f). Set the test-receiver system to Peak Detect Function and specified bandwidth with Maximum Hold Mode.
- g). If the emission level of the EUT in peak mode was 3 dB lower than the limit specified, then testing will be stopped and peak values of EUT will be reported, otherwise, the emissions which do not have 3 dB margin will be repeated one by one using the quasi-peak method and reported.
- h). The central point of the EUT shall be positioned at the centre of the turntable. The measurement distance is the shortest horizontal distance between an imaginary circular periphery just encompassing this arrangement and the calibration point of the antenna.

5.1.3. Measurement Results Calculation

The measurand Level is calculated using:

Corrected Reading (dB μ V/m) = Antenna Factor + Cable Loss + Read Level – Preamp Factor

For example at 125 MHz if the Antenna Factor is 17.24 dB/m, the cable loss is 1.20 dB, the measured voltage is 35.80 dB μ V and the Preamp Factor is 27.18 dB, the signal strength would be calculated:

Corrected Reading (dB μ V/m) = 17.24 dB/m + 1.20 dB + 35.80 dB μ V - 27.18 dB = 27.06 dB μ V/m

Note: If a hybrid antenna is used, the antenna factor shall be the sum of the Antenna Factor + Attenuator Factor.

5.1.4. Typical Test Setup Layout

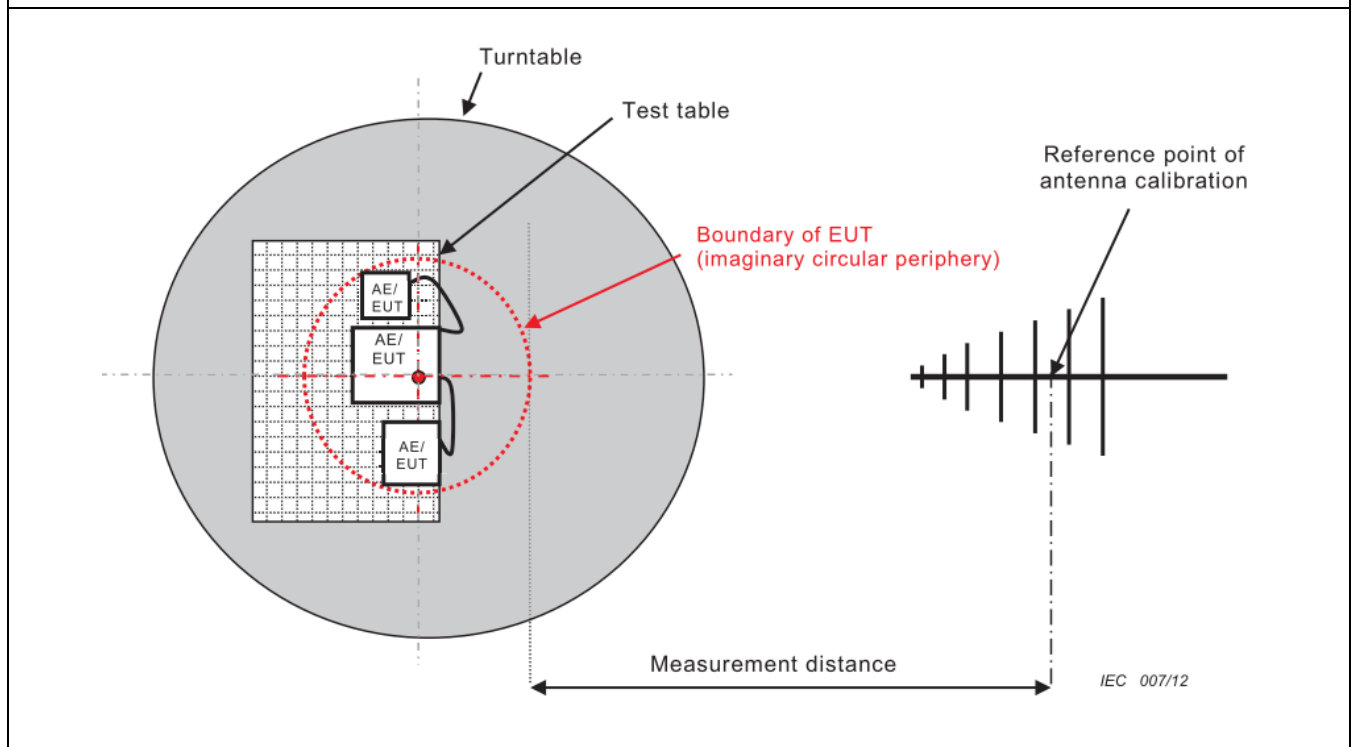
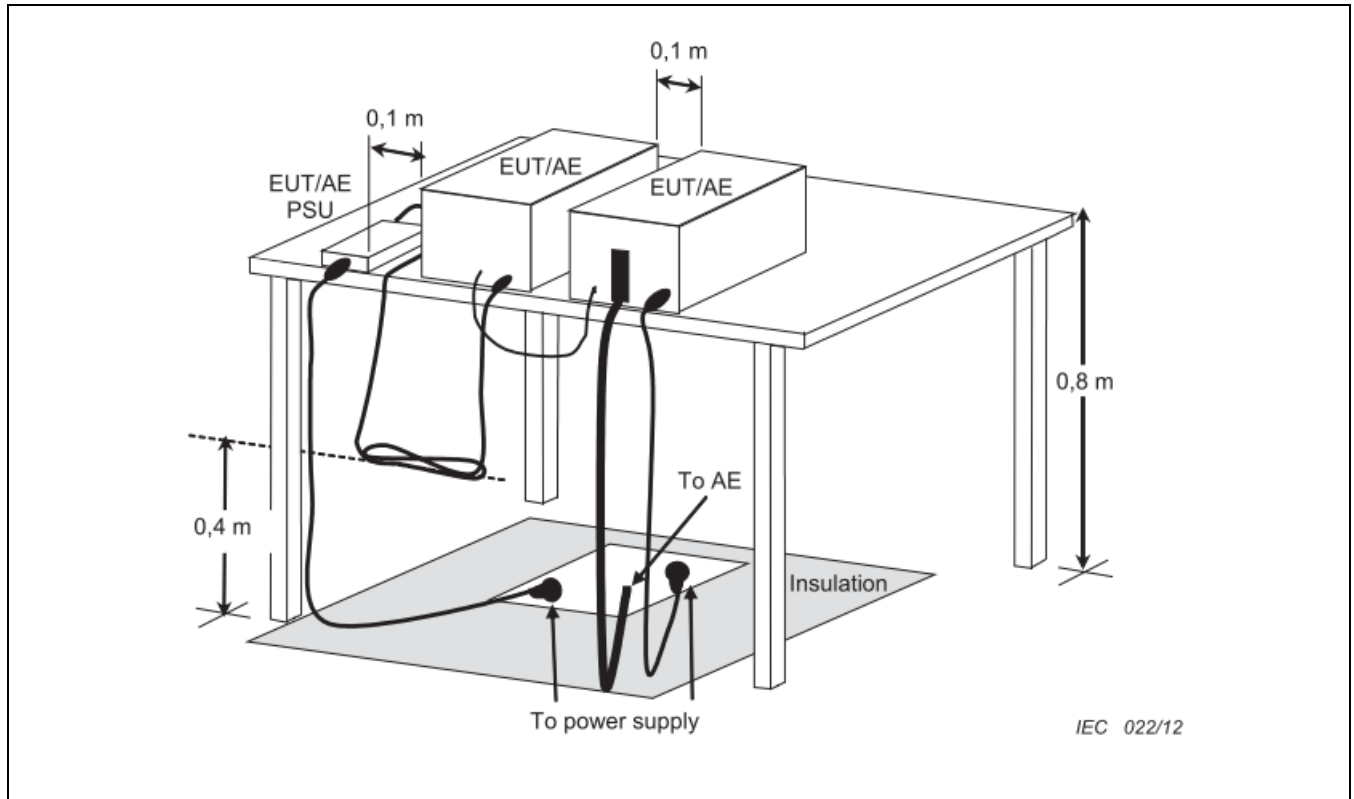



5.1.5. Test Result

Test mode	Mode 1		
Test frequency	30 MHz ~ 1000 MHz	Test Voltage	AC 240V / 50Hz
<p>■ The test was passed at the minimum margin that marked by the frame in the following data</p>			

Vertical

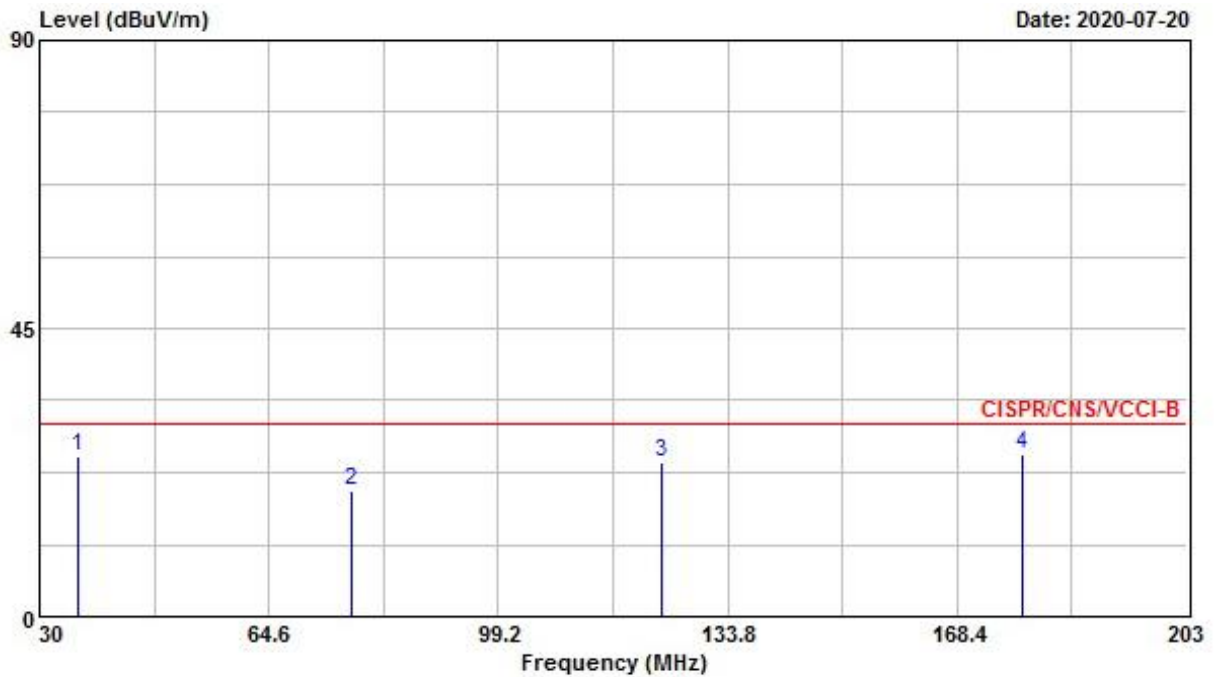

	Freq	Level	Over Limit	Limit Line	ReadAntenna	Cable	Preamp	Remark	Ant Pos	Table Pos
	MHz	dBuV/m	dB	dBuV/m	dBuV	dB/m	dB	dB	cm	deg
1 @	35.880	24.97	-5.03	30.00	32.03	19.69	1.12	27.87	Peak	---
2	77.060	19.54	-10.46	30.00	34.14	11.63	1.65	27.88	Peak	---
3 @	123.770	23.97	-6.03	30.00	32.23	17.43	2.06	27.75	Peak	---
4 @	178.260	25.25	-4.75	30.00	35.84	14.43	2.49	27.51	QP	100 177



Vertical

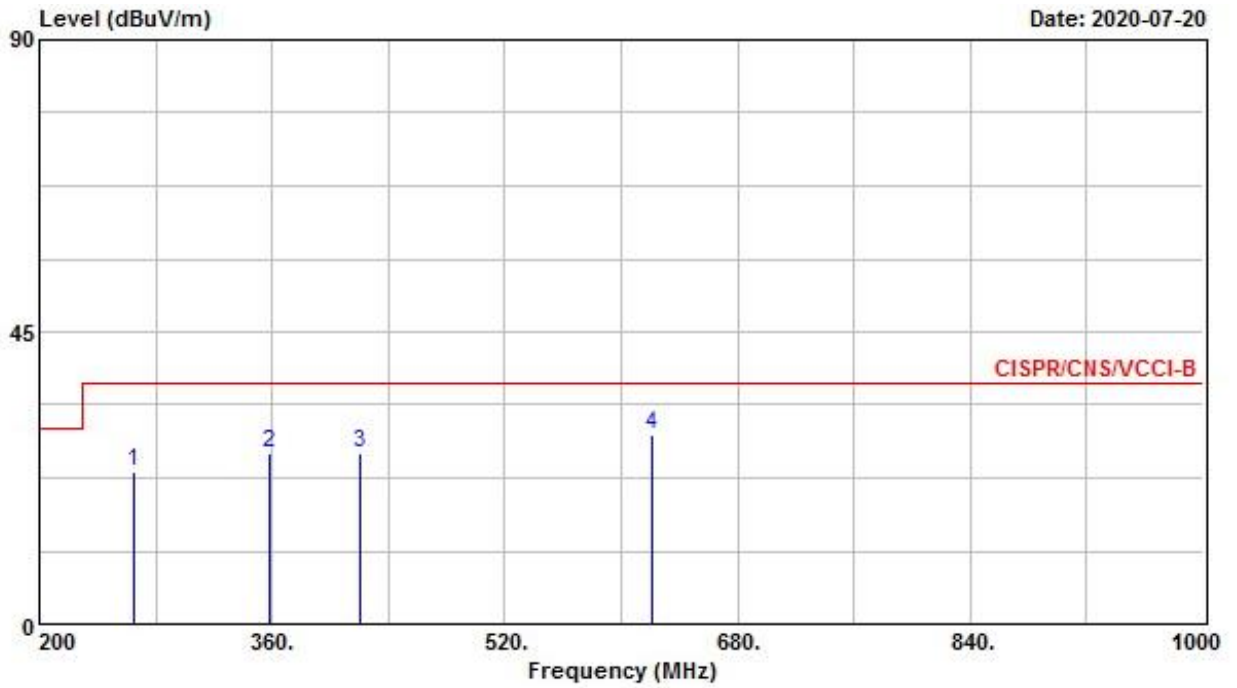

	Freq	Level	Over Limit	Limit Line	ReadAntenna Level	Antenna Factor	Cable Loss	Preamp Factor	Remark	Ant Pos	Table Pos
	MHz	dBuV/m	dB	dBuV/m	dBuV	dB/m	dB	dB		cm	deg
1	265.600	23.47	-13.53	37.00	29.26	18.16	3.26	27.21	Peak	---	---
2	358.400	26.25	-10.75	37.00	30.44	19.63	3.72	27.54	Peak	---	---
3	420.800	26.18	-10.82	37.00	28.49	21.76	3.93	28.00	Peak	---	---
4	620.800	29.06	-7.94	37.00	28.33	23.77	5.50	28.54	Peak	---	---



Horizontal

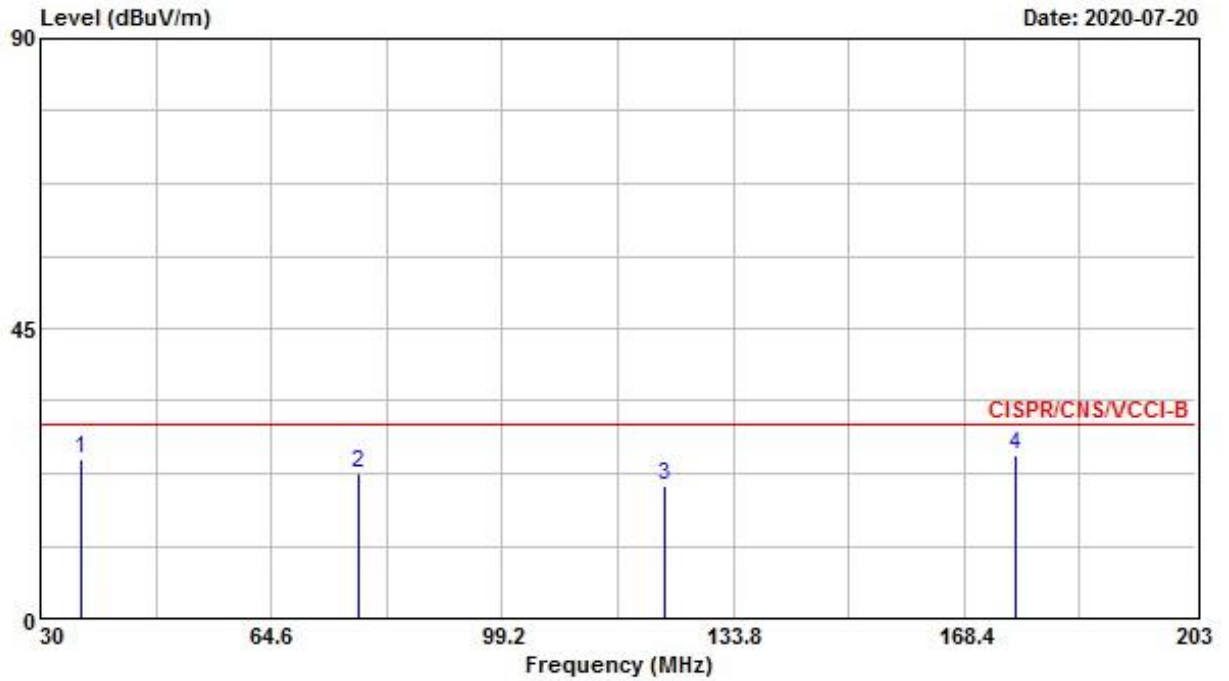

	Freq	Level	Over Limit	Limit Line	ReadAntenna Level	Antenna Factor	Cable Loss	Preamp Factor	Remark	Ant Pos	Table Pos
	MHz	dBuV/m	dB	dBuV/m	dBuV	dB/m	dB	dB		cm	deg
1 @	36.060	24.62	-5.38	30.00	31.68	19.69	1.12	27.87	Peak	---	---
2	77.750	22.42	-7.58	30.00	37.02	11.63	1.65	27.88	Peak	---	---
3	123.590	20.52	-9.48	30.00	28.69	17.54	2.05	27.76	Peak	---	---
4 @	176.190	25.24	-4.76	30.00	35.86	14.42	2.48	27.52	Peak	---	---



Horizontal

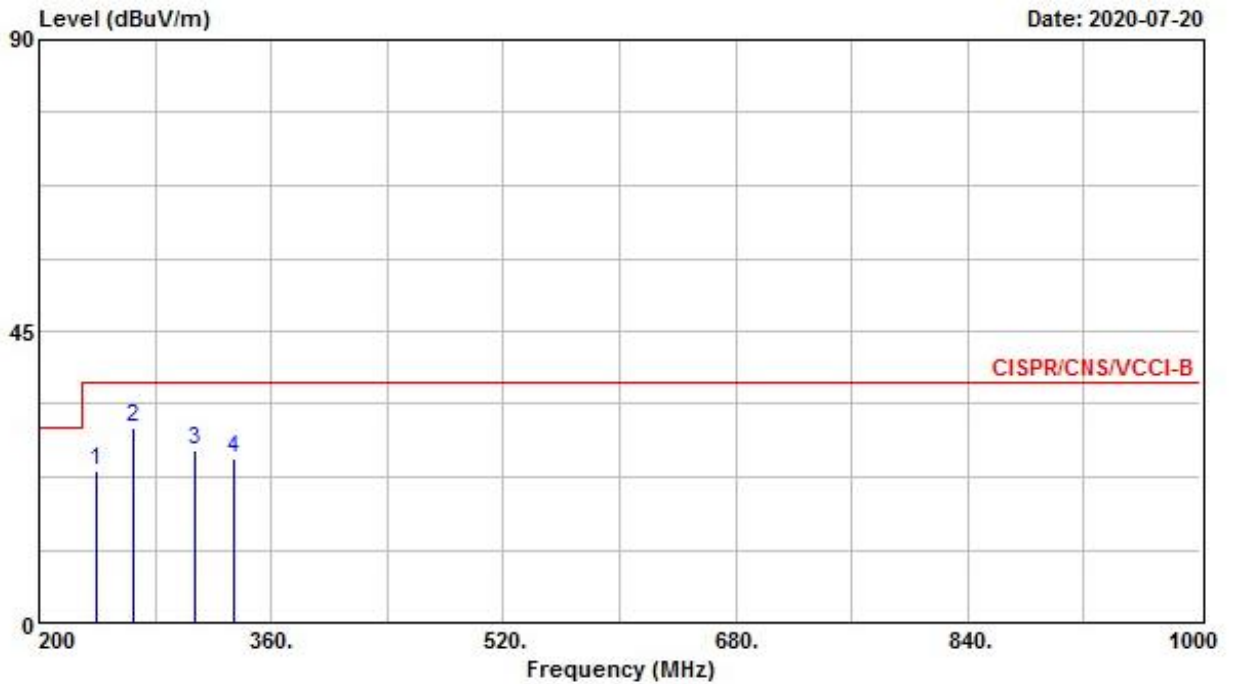

	Freq	Level	Over Limit	Limit Line	ReadAntenna Level	Antenna Factor	Cable Loss	Preamp Factor	Remark	Ant Pos	Table Pos
	MHz	dBuV/m	dB	dBuV/m	dBuV	dB/m	dB	dB		cm	deg
1	240.000	23.52	-13.48	37.00	31.33	16.30	3.12	27.23	Peak	---	---
2	265.600	30.09	-6.91	37.00	35.88	18.16	3.26	27.21	Peak	---	---
3	308.000	26.50	-10.50	37.00	31.80	18.53	3.45	27.28	Peak	---	---
4	333.600	25.45	-11.55	37.00	30.37	18.87	3.60	27.39	Peak	---	---



5.2. Radiated Emission above 1GHz

5.2.1.Limit

radiated emissions at frequencies above 1 GHz for Class A equipment			
Frequency range MHz	Measurement		Class A limits dB(µV/m)
	Distance (m)	Detector type / bandwidth	SAC
1000 – 3000	3	Average / 1 MHz	56
3000 – 6000			60
1000 – 3000		Peak / 1 MHz	76
3000 – 6000			80

radiated emissions at frequencies above 1 GHz for Class B equipment			
Frequency range MHz	Measurement		Class B limits dB(µV/m)
	Distance (m)	Detector type / bandwidth	SAC
1000 – 3000	3	Average / 1 MHz	50
3000 – 6000			54
1000 – 3000		Peak / 1 MHz	70
3000 – 6000			74

Required highest frequency for radiated measurement	
Highest internal frequency (F_x)	Highest measured frequency
$F_x \leq 108$ MHz	1 GHz
108 MHz < $F_x \leq 500$ MHz	2 GHz
500 MHz < $F_x \leq 1$ GHz	5 GHz
$F_x > 1$ GHz	$5 \times F_x$ up to a maximum of 6 GHz

5.2.2. Test Procedures

- a). Same test set up as below 1GHz radiated testing.
- b). The EUT was set 3 meter from the interference-receiving antenna which was mounted on the top of a variable height antenna tower.
- c). There should be absorber placed between the EUT and Antenna and its located size should let the test site meet CISPR16-1-4 requirement.
- d). The table was rotated 360 degrees to determine the position of the highest radiation.
- e). The measured using a test-receiver system with both a peak and CISPR average detector.
- f). Set the DRG Horn Antenna at 1M height, then run the turn table to get the maximum noise reading from Horizontal and Vertical polarity separately.t the test-receiver system to Peak Detect Function and specified bandwidth with Maximum Hold Mode.
- g). When EUT locating on the turn-table, and its height is over 172cm (Antenna’s 3dB beam width of 6GHz is 27°), the DRG Horn Antenna must be raised up and descended down, then turning around the turn-table to get the maximum noise reading of the Horizontal and Vertical polarity separately. Note the maximum raise up height is same as the top of EUT.
- h). If emission level of the EUT in peak mode was 20dB lower than average limit (that means the emission level in peak mode also complies with the limit in average mode), then testing will be stopped and peak values of EUT will be reported, otherwise, the emissions will be measured in average mode again and reported.
- i). The central point of the EUT shall be positioned at the centre of the turntable. The measurement distance is the shortest horizontal distance between an imaginary circular periphery just encompassing this arrangement and the calibration point of the antenna.

5.2.3.Measurement Results Calculation

The measurand Level is calculated using:

Corrected Reading (dB μ V/m) = Raw(Read Level)+AF(Antenna Factor)+CL(Cable Loss)-PA(Preamp Factor)

For example at 1980 MHz if the Antenna Factor is 26.19 dB/m, the cable loss is 4.08 dB, the measured voltage is 51.30 dB μ V and the Preamp Factor is 33.34 dB, the signal strength would be calculated:

Corrected Reading (dB μ V/m) = 51.30 dB μ V + 26.19 dB/m + 4.08 dB + - 33.34 dB = 48.23 dB μ V/m

5.2.4.Typical Test Setup Layout

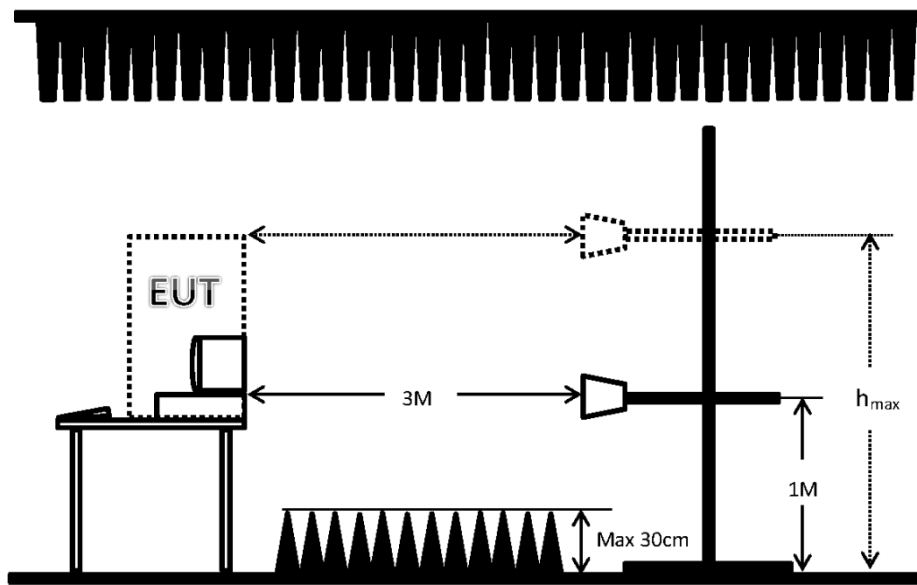

Remark: When EUT's height is over 172cm, h_{max} = top of EUT



5.2.5. Test Result

Test mode	Mode 1		
Test frequency	1 GHz ~ 6 GHz	Test Voltage	AC 240V / 50Hz
<p>■ The test was passed at the minimum margin that marked by the frame in the following data</p>			

Vertical

Mode 1

24/07/2020

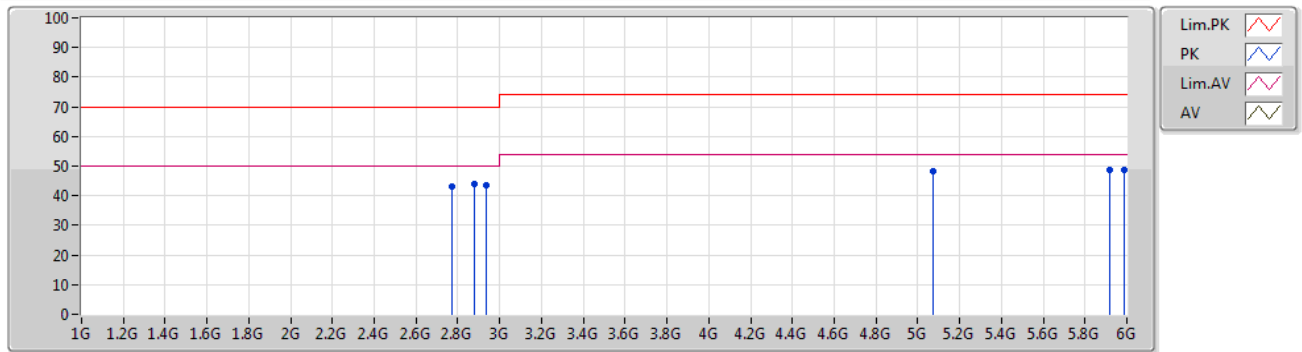

Type	Freq (Hz)	Level (dBuV/m)	Limit (dBuV/m)	Margin (dB)	Factor (dB)	Dist (m)	Condition	Azimuth (°)	Height (m)	Comment	Raw (dBuV)	AF (dB/m)	CL (dB)	PA (dB)
PK	2.77G	42.98	70.00	-27.02	-2.14	3	Vertical	-	-	-	45.12	27.94	4.70	34.78
PK	2.88G	43.79	70.00	-26.21	-1.70	3	Vertical	-	-	-	45.49	28.26	4.82	34.78
PK	2.935G	43.65	70.00	-26.35	-1.44	3	Vertical	-	-	-	45.09	28.44	4.90	34.78
PK	5.075G	48.23	74.00	-25.77	4.76	3	Vertical	-	-	-	43.47	31.80	7.22	34.26
PK	5.915G	48.85	74.00	-25.15	5.35	3	Vertical	170	1	"Worst"	43.50	32.36	7.23	34.24
PK	5.99G	48.70	74.00	-25.30	5.56	3	Vertical	-	-	-	43.14	32.42	7.38	34.24



Horizontal

Mode 1

24/07/2020

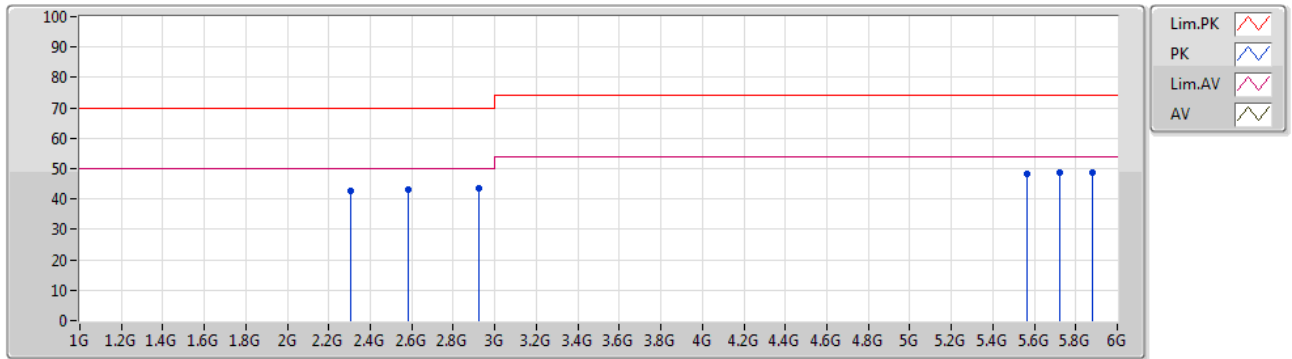

Type	Freq (Hz)	Level (dBuV/m)	Limit (dBuV/m)	Margin (dB)	Factor (dB)	Dist (m)	Condition	Azimuth (°)	Height (m)	Comment	Raw (dBuV)	AF (dB/m)	CL (dB)	PA (dB)
PK	2.305G	42.80	70.00	-27.20	-2.55	3	Horizontal	-	-	-	45.35	27.87	4.36	34.78
PK	2.58G	43.10	70.00	-26.90	-2.60	3	Horizontal	-	-	-	45.70	27.50	4.68	34.78
PK	2.925G	43.60	70.00	-26.40	-1.49	3	Horizontal	-	-	-	45.09	28.40	4.89	34.78
PK	5.565G	48.39	74.00	-25.61	4.42	3	Horizontal	-	-	-	43.97	31.76	6.88	34.22
PK	5.72G	48.84	74.00	-25.16	4.73	3	Horizontal	-	-	-	44.11	32.00	6.96	34.23
PK	5.88G	48.85	74.00	-25.15	5.18	3	Horizontal	188	1	"Worst"	43.67	32.26	7.16	34.24



6. Uncertainty of Test Site

ISO/IEC 17025 requires that an estimate of the measurement uncertainties associated with the emissions test results be included in the report. The measurement uncertainties given below are based on a 95% confidence level (based on a coverage factor (k=2)).

6.1. Emission Test Measurement Uncertainty

Test Items	Test Site No.	U_{LAB}
Conducted Emissions	CO01-NH	2.7 dB
Radiated Emissions below 1GHz	OS03-NH	5.9 dB
Radiated Emissions above 1GHz	03CH04-HY	6.47 dB



7. List of Measuring Equipment Used

Conducted Emission - Test Date: 20/Jul/2020

Instrument	Manufacturer	Model No.	Serial No.	Characteristics	Calibration Date	Remark
EMI Receiver	R&S	ESR3	102318	9K Hz – 3.6 GHz	30/Jul/2019	Conduction (CO01-NH)
LISN	SCHAFFNER	NNB41	06/10024	9kHz - 30MHz	27/Dec/2019	Conduction (CO01-NH)
Power Filter	CORCOM	MR12030	N/A	30A*2	NCR	Conduction (CO01-NH)
RF Cable-CON	Suhner Switzerland	RG223/U	CB004	9kHz - 30MHz	26/Dec/2019	Conduction (CO01-NH)
software	Audix	E3	6.12160806	-	NCR	Conduction (CO01-NH)

Note: Calibration Interval of instruments listed above is one year. NCR: No Calibration Request.

Radiated Emission below 1GHz - Test Date: 20/Jul/2020

Instrument	Manufacturer	Model No.	Serial No.	Characteristics	Calibration Date	Remark
Open Area Test Site	SPORTON	OATS-10	OS03-NH	30 MHz - 1 GHz 10m, 3m	22/Oct/2019	Radiation (OS03-NH)
Amplifier	HP	8447D	2944A08292	0.1 MHz - 1.3 GHz	03/Jul/2020	Radiation (OS03-NH)
Spectrum Analyzer	R&S	FSP7	838858/038	9 kHz – 7GHz	27/Apr/2020	Radiation (OS03-NH)
Receiver	R&S	ESCS30	838251/002	9 kHz –2.75 GHz	13/Jul/2020	Radiation (OS03-NH)
Bilog Antenna With 5dB Attenuator	CHASE	CBL6112D	25234	30 MHz - 2 GHz	26/Apr/2020	Radiation (OS03-NH)
Turn Table	EMCO	2080	9805-2065	0 - 360 degree	NCR	Radiation (OS03-NH)
Antenna Mast	EMCO	2075	9804-2151	1 m - 4 m	NCR	Radiation (OS03-NH)
RF Cable-R10m	HSCN	RG213U	2X11N	30 MHz - 1 GHz	17/Jul/2020	Radiation (OS03-NH)
Software	Audix	E3	Ver.4	-	NCR	Radiation (OS03-NH)

Note: Calibration Interval of instruments listed above is one year. NCR: No Calibration Request.

**Radiated Emission above 1GHz - Test Date: 24/Jul/2020**

Instrument	Manufacturer	Model No.	Serial No.	Characteristics	Calibration Date	Calibration Due Date	Remark
EMI Test Receiver	R&S	ESU-26	100422	20Hz ~ 26.5GHz	23/Oct/2019	22/Oct/2020	Radiation (03CH04-HY)
3m Semi Anechoic Chamber (Site V.S.W.R)	RIKEN	3m SAC	03CH04-HY	1 GHz ~ 18 GHz 3m	27/Feb/2020	26/Feb/2021	Radiation (03CH04-HY)
Microwave Preamplifier	Agilent	8449B	3008A02602	1GHz~26.5GHz	20/Mar/2020	19/Mar/2021	Radiation (03CH04-HY)
Horn Antenna	SCHWARZBECK	BBHA9120	BBHA9120D018 34	1 GHz ~ 18 GHz	06/Feb/2020	05/Feb/2021	Radiation (03CH04-HY)
Turn Table	Chaintek	3000	MF7802056	0 ~ 360 degree	NCR	NCR	Radiation (03CH04-HY)
Antenna Mast	MF	MF-7802	MF780208163	1 ~ 4 m	NCR	NCR	Radiation (03CH04-HY)
RF Cable	SUHNER	SUCOFLEX 104	CB001-03CH01	30MHz~18GHz	02/Mar/2020	01/Mar/2021	Radiation (03CH04-HY)
Software	Sporton	SENSE-EMI	V5.10.7	-	NCR	NCR	Radiation (03CH04-HY)

NCR: No Calibration Request.

Appendix A. Test Photos

1. Photographs of Conducted Emissions Test Configuration

Front View



Side View

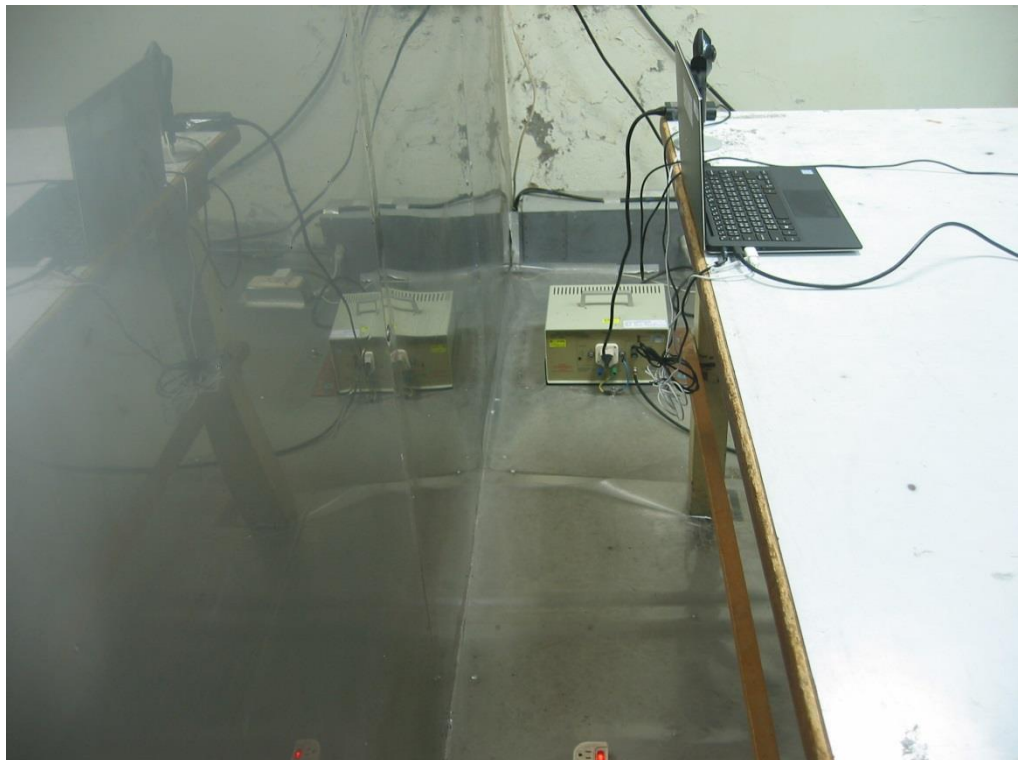

Under Table View



2. Photographs of Radiated Emissions Test Configuration

For radiated emissions below 1GHz

Front View

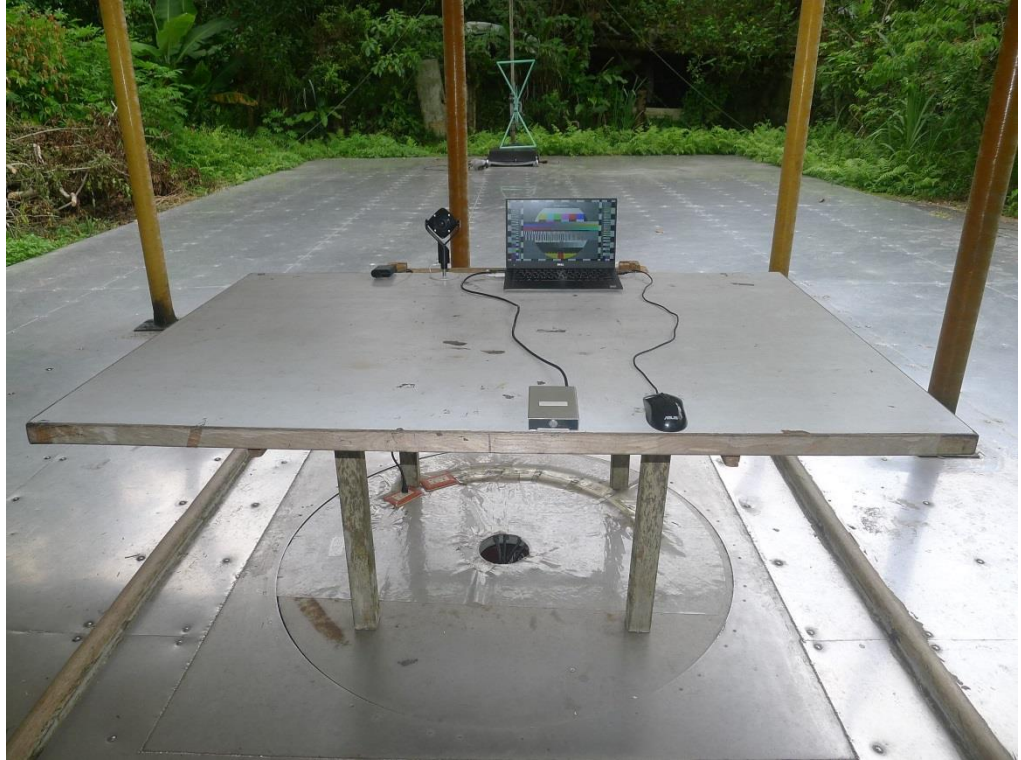

Rear View



For radiated emissions above 1GHz

Front View

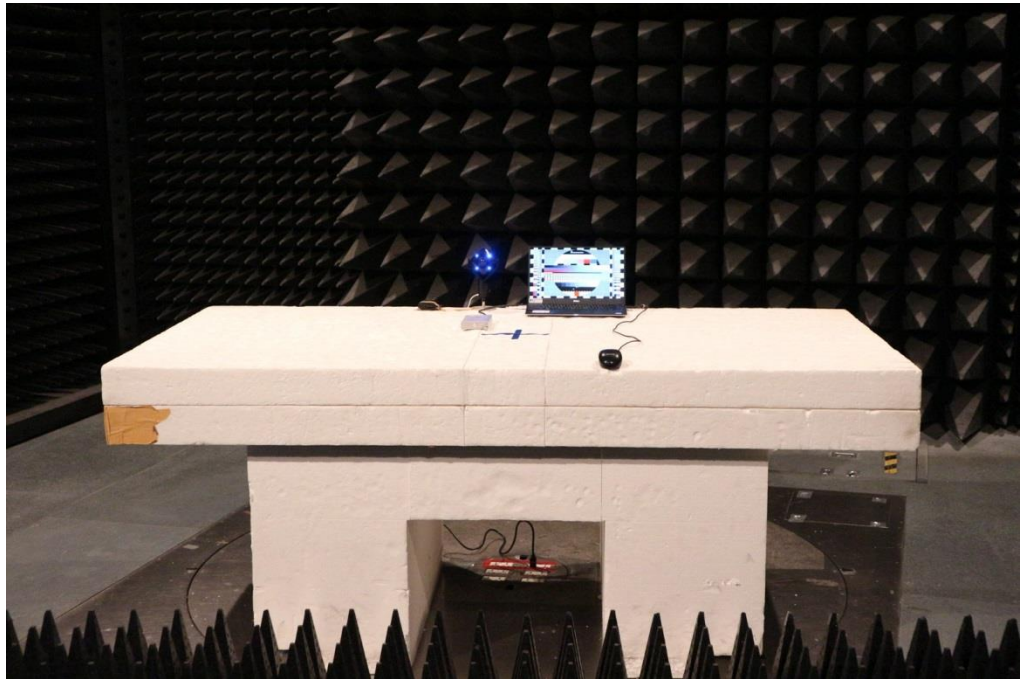

Rear View



————THE END————