

Dell Dual Charge Dock

User Guide

Notes, cautions, and warnings

 **NOTE:** A NOTE indicates important information that helps you make better use of your product.

 **CAUTION:** A CAUTION indicates either potential damage to hardware or loss of data and tells you how to avoid the problem.

 **WARNING:** A WARNING indicates a potential for property damage, personal injury, or death.

Contents

Chapter 1: Introduction.....	4
Chapter 2: What's in the box.....	5
Chapter 3: Hardware requirements.....	6
Chapter 4: Views of Dell Dual Charge Dock - HD22Q.....	7
Back.....	7
Front.....	7
Left.....	8
Right.....	8
Chapter 5: Important Information.....	9
Chapter 6: Setting up your docking station.....	10
Charging your phone.....	11
Orientations supported for wireless charging.....	11
Charging your wireless earbuds.....	12
Chapter 7: Setting up external monitors.....	13
Configuring your Monitors.....	13
Display Resolution Table.....	14
Chapter 8: Technical specifications.....	16
Product specifications.....	16
Wireless Qi charging specifications.....	17
Docking cable specifications.....	17
Power adapter specifications.....	17
LED indicators	18
Dimensions and weight.....	18
Docking specifications.....	18
Chapter 9: Dell docking station firmware update	19
Chapter 10: Troubleshooting the Dell Dual Charge Dock - HD22Q.....	22
Symptoms and solutions.....	22
Chapter 11: Getting help and contacting Dell.....	26

Introduction

The Dell Dual Charge Dock - HD22Q is a device that links all your electronic devices to your system using a USB Type-C cable interface. Connecting the system to the docking station allows you to easily connect multiple peripherals (mouse, keyboard, stereo speakers, external hard-drives, and high-resolution displays) without having to plug each one into the system.

The dock also supports wireless charging for supported mobile devices.

CAUTION: Update your system's BIOS, graphic drivers and the Dell docking station drivers to the latest versions available at www.dell.com/support before using the docking station. Older BIOS versions and drivers could result in your system not recognizing the docking station or not functioning optimally. Always check if any recommended firmware is available for your docking station at www.dell.com/support.

What's in the box

Your docking station ships with the components shown below:

1. Docking station
2. Power cord
3. Power adapter
4. Documentation (Quick Start Guide, Safety, Environmental, and Regulatory Information)

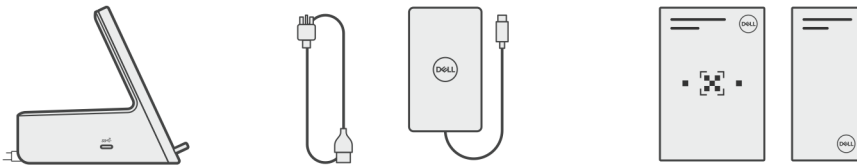

i **NOTE:** Contact Dell support if any of the listed items are missing from your box.

Hardware requirements

Before using the docking station, ensure that your system has a USB Type-C with DisplayPort Alt Mode that is designed to support the docking station.

Views of Dell Dual Charge Dock - HD22Q

Back

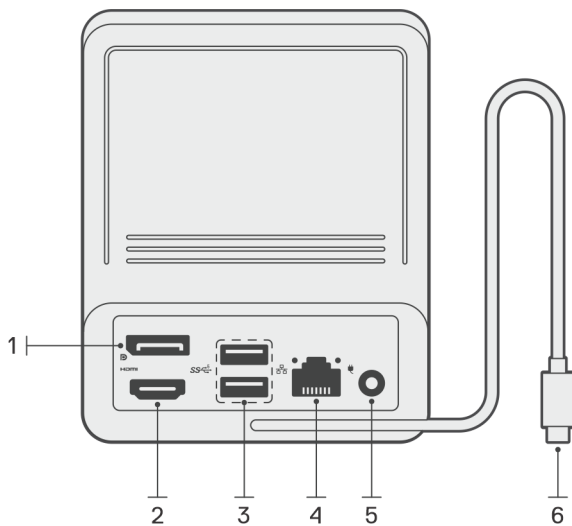

1. DisplayPort 1.4 port
2. HDMI 2.1 port
3. Two USB 3.2 Gen 1 ports
4. Network connector (RJ-45)
5. Power connector
6. USB Type-C cable

Front

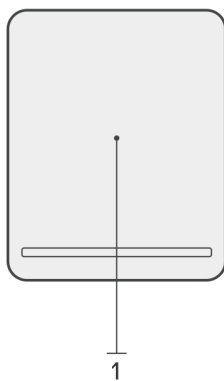

1. Wireless charging pad

Left

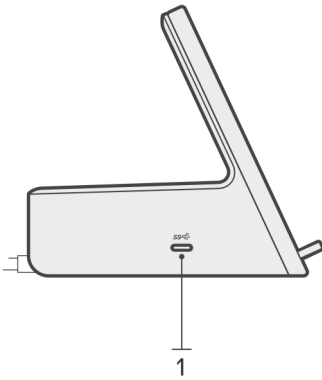

1. USB 3.2 Gen 2 Type-C port with PowerDelivery 3.0 (5 V / 3 A, 15 W)

Right

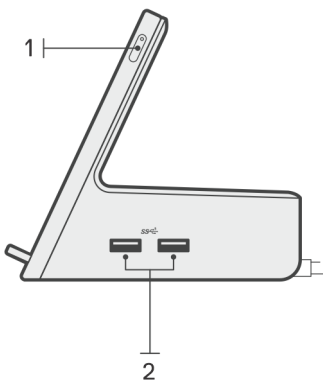

1. Power button with LED
2. Two USB 3.2 Gen 1 ports

Important Information

Updating drivers on your system

It is recommended to update the following drivers on your system before using the docking station:

1. System BIOS
2. Graphics driver
3. Ethernet driver

 **CAUTION: Older BIOS versions and drivers could result in the docking station not being recognized by your system or not functioning optimally.**

For Dell systems, you can visit www.dell.com/support and enter the Service Tag or Express Service Code to find all relevant drivers. For more information on how to find the Service Tag for your computer, see [Locate the Service Tag on your computer](#).

For non-Dell systems, please visit the respective manufacturers support page to find the latest drivers.

Updating the Dell Dual Charge Dock - HD22Q driver set

To ensure that the Dock functions correctly, it is recommended installing the latest firmware available for the HD22Q.

All available drivers can be found on www.dell.com/support.

Drivers and Downloads FAQ

When troubleshooting, downloading or installing drivers it is recommended that you read the Dell Knowledge Based article, Drivers and Downloads FAQ [000123347](#).

Setting up your docking station

Steps

1. Update your system's BIOS, graphics, and network drivers from www.dell.com/support/drivers.

CAUTION: Ensure that the system is connected to a power source while installing the BIOS and drivers.

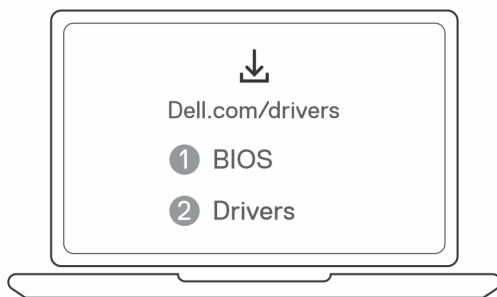

2. Connect the AC adapter to a power outlet. Then, connect the AC adapter to the 7.4 mm DC-in power input on the Dell Dual Charge Dock - HD22Q.

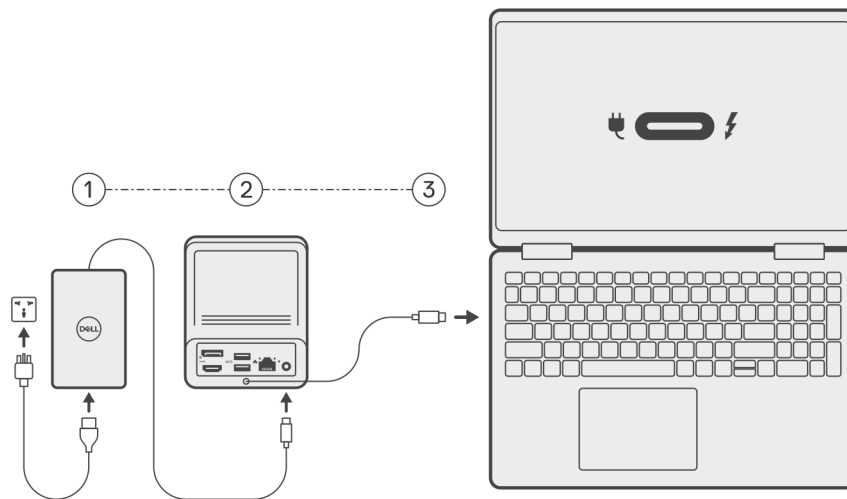

3. Connect the USB Type-C connector to the system.

Update the Dell Dual Charge Dock drivers from www.dell.com/support/drivers.

4. Connect the displays (up to 2 direct connection via DisplayPort and HDMI ports) to the docking station, as needed.

For more details on supported display resolutions and setting up additional displays, please see [Display Resolution](#).

NOTE: The [USB 3.2 Gen 2 Type-C port](#) on the dock is not DisplayPort Alt Mode capable and won't support a video display.

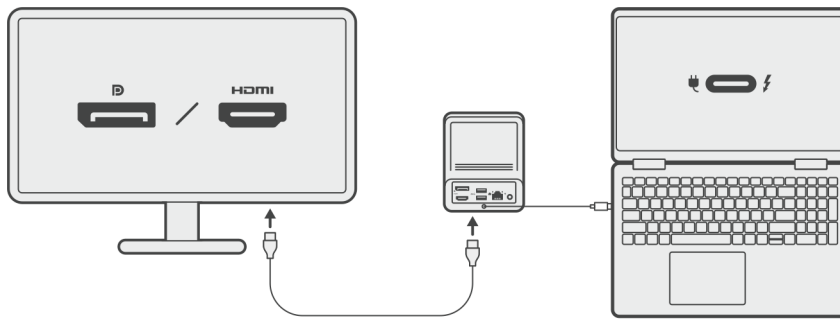

Charging your phone

About this task

The Dell Dual Charge Dock - HD22Q features a wireless charging pad for charging supported mobile devices.

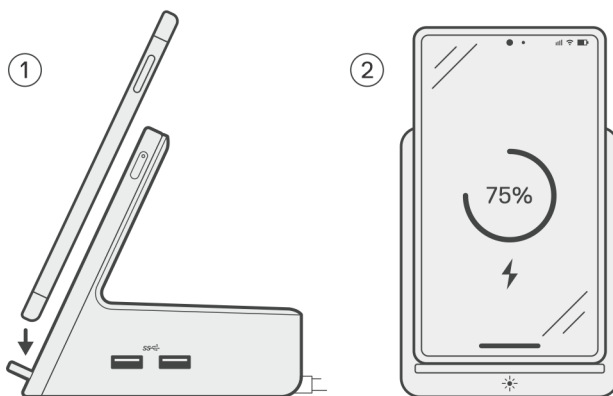

Steps

1. Align and place the phone on the charging pad.
2. The Qi charging LED should turn solid white and the phone should start charging automatically.

Orientations supported for wireless charging

The Dell Dual Charge Dock - HD22Q has a 3-coil design that supports wireless charging on mobile devices of different sizes. You can charge your mobile device on portrait or landscape mode, based on your device size and preference.

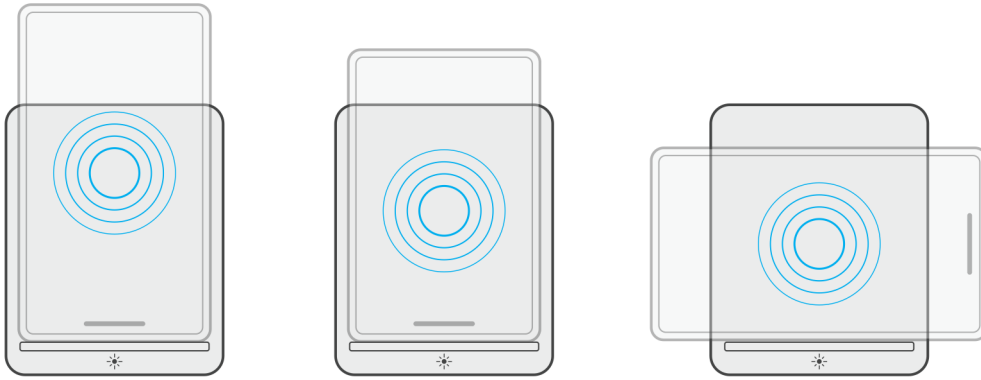

As seen in the images above, the charging coils are spread out to ensure that devices of all sizes have no difficulty charging when placed on the wireless charging pad.

1. Portrait mode charging on larger phones
2. Portrait mode charging on smaller phones
3. Landscape mode charging

The Qi charging LED helps identify the charging status on the docking station. For more information, please see [LED indicators](#).

CAUTION: Mobile devices without Qi certifications may not charge as expected on the Dell Dual Charge Dock - HD22Q.

CAUTION: Ensure that there are no metal objects (phone cover, magnetic mobile holder plate etc.) between the mobile device and the wireless charging pad on the dock.

Charging your wireless earbuds

About this task

The Dell Dual Charge Dock - HD22Q can also be used to charge wireless earbuds. The placement and orientation of the charging case on the charging pad may vary depending on the type of earbuds and the size of the case.

Setting up external monitors

Configuring your Monitors

If connecting two displays, follow these steps:

Steps

1. Click the **Start** button, and then select **Settings**.
2. Click **System** and select **Display**.

3. Under the **Multiplay displays** section, modify the display configuration as needed.

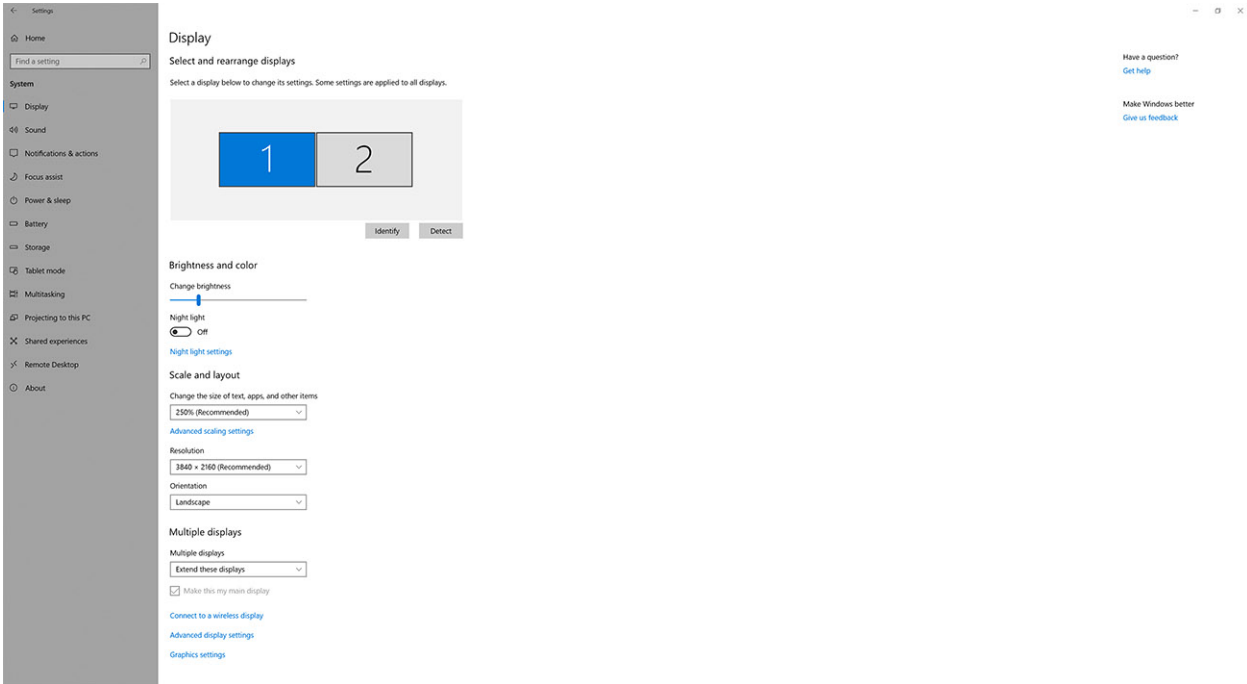

NOTE: The display topology can be configured, by moving around the displays in the "Select and rearrange displays" section, to change where the operating system assumes these monitors are located.

Display Resolution Table

Display matrix for Dell Dual Charge Dock HD22Q

Table 1. Display matrix for Dell Dual Charge Dock HD22Q



Display Port Available Bandwidth	Single Display (maximum resolution)	Dual Display (maximum resolution)	Triple Display (maximum resolution)	Quad Display (maximum resolution) ****
HBR2 (HBR2 x2 lanes - 8.6 Gbps)	DP 1.4/HDMI 2.1: 4K (3840 x 2160) @30 Hz	DP 1.4 + HDMI 2.1: FHD (1920 x 1080) @ 60 Hz	HDMI 2.1: FHD (1920 x 1080) @60 Hz DP 1.4: 2 x HD (1280 x 720) @60Hz**	Not supported
HBR3 (HBR3 x2 lanes - 12.9 Gbps)	DP 1.4/HDMI 2.1: 4K (3840 x 2160) @30 Hz	DP 1.4 + HDMI 2.1: QHD (2560 x 1440) @60 Hz	HDMI 2.1: FHD (1920 x 1080) @60 Hz DP 1.4: 2 x HD (1280 x 720) @60Hz**	HDMI 2.1: FHD (1920 x 1080) @60 Hz DP 1.4: 3 x HD (1280 x 720) @60Hz**
HBR3 with DSC (Display Stream Compression)	DP 1.4: 8K (7680 x 4320) @ 30 Hz OR HDMI 2.1: 4K (3840 x 2160) @60 Hz or 4K (3840 x 2160) @120 Hz*** or 8K (7680 x 4320) @ 30 Hz ***	DP 1.4 + HDMI 2.1: 4K (3840 x 2160) @60 Hz	HDMI 2.1: QHD (2560 x 1440) @ 60 Hz DP 1.4: 2 x QHD (2560 x 1440) @ 60 Hz**	HDMI 2.1: QHD (2560 x 1440) @ 60 Hz DP 1.4: 3 x QHD (2560 x 1440) @ 60 Hz**

**Third and fourth display must be daisy-chained through the DisplayPort (DP) 1.4 port using Multi-Stream Transport (MST) monitors connected to the DP 1.4 port. All DisplayPort (DP) connected monitors should have Display Stream Compression (DSC) support. If non-DSC monitors are used, then maximum resolution (HD: 1280 x 720) is the same as HBR3 non-DSC (12.9Gbps) offerings.

*** This resolution is supported when using HDMI 2.1 monitor with Fixed Rate Link support for higher video resolution and refresh rate. An HDMI 2.1 cable is also required for this display resolution.

**** Quad display setup functions only in LCD off mode.

Important

-  **NOTE:** If higher resolution monitors are used, the Graphics driver makes a judgment based on monitor specifications and display configurations. Some resolutions may not be supported and so will be removed from the Windows Display Control Panel.
-  **NOTE:** Linux operating system is unable to physically turn-off built-in display, the external display numbers will be one less than the display numbers listed in above tables.
-  **NOTE:** Resolution support is also dependent on the monitor's Extended Display Identification Data (EDID) resolution.

Technical specifications

Product specifications

Table 2. Product specifications

Feature	Specifications
Model	HD22Q
Video ports	<ul style="list-style-type: none"> • DisplayPort 1.4 port (rear) • HDMI 2.1 port (rear)
External displays supported	Up to 4
USB Type-A ports	<ul style="list-style-type: none"> • Two USB 3.2 Gen 1 (rear) • Two USB 3.2 Gen 1 (right)
USB Type-C ports	<ul style="list-style-type: none"> • USB 3.2 Gen 2 Type-C with PowerDelivery 3.0
Network	<p>Gigabit Ethernet (RJ-45)</p> <p>Support Wake On LAN from S0, S3, S4, or S5 sleep state with select Dell systems. See platform setup guide for more details.</p> <p>Support MAC Address Pass-Through with select Dell systems. See platform setup guide for more details.</p>
LED indicators	<ul style="list-style-type: none"> • Power button LED • Qi charging LED • RJ-45 LEDs
AC adapter options	130 W
DC-in Port	7.4 mm
Cable	0.8 m for HD22Q
Power delivery	<ul style="list-style-type: none"> • 90 W to system with 130 W AC-adapter
System requirements	Compatible with USB Type-C systems with DisplayPort Alt Mode
Power button function	<p>Sleep/Wakeup/Power button</p> <p> NOTE: For Dell systems, the power button mimics the host power button behavior.</p>
Operating systems	<ul style="list-style-type: none"> • Windows 10 • Windows 11 • Ubuntu 20.04 and later version
Systems management	<ul style="list-style-type: none"> • Wireless vPro supported by the notebook, tablet, or workstation • Kernel Direct Memory Access (DMA) protection
MAC address	Pass-through MAC address

Wireless Qi charging specifications

Table 3. Wireless charging specifications

Type	Value
Charger type	Qi 1.3 certified
Fast charge	Up to 12 W

Docking cable specifications

Table 4. Docking cable specifications

Type	USB Type-C
Color	Magnetite
Length	800 mm
Signal bandwidth	Up to 20 Gbps
Voltage rating	5 V to 20 V
Minimum bend radius	11.2 mm
Notebook/Tablet Connection Types	Type-C

Power adapter specifications

Table 5. Power adapter specifications

Dell AC Adapter Specifications	130 W
Input voltage	100 to 240 VAC
Input current (max)	2.5 A
Input frequency	50 to 60 Hz
Output current	6.67 A (continuous)
Rated output voltage	19.5 VDC
Weight (lb)	0.91
Weight (kg)	0.413
Dimensions (in.)	1.0 x 3.0 x 6.1
Dimensions (mm)	25.4 x 76.2 x 154.7
Temperature range operating	0°C to 40°C 32°F to 104°F
Storage	-40°C to 70°C -40°F to 158°F

LED indicators

Table 6. Docking station LED indicator

State	LED behavior
Docking station is receiving power from power adapter	Flash three times

Table 7. RJ-45 LED indicator

Link speed indicators	Ethernet activity indicator
10 Mb = Green	Blinking yellow during network activity
100 Mb = Amber	
1 Gb = Green + Amber	

Table 8. Qi charging LED indicator

State	LED behavior
Docking station is receiving power from power adapter	Flashes white light for 3 seconds
Compatible Qi device is placed on the charging pad and the device is charging	Solid white light  NOTE: The solid white light dims after 10 seconds.
Dock detects abnormal charging behavior, incompatible or incorrect placement of device on the charging pad	Blinking amber light For more details on troubleshooting, please see Symptoms and solutions .
No device placed on charging pad	No light

Dimensions and weight

Table 9. Dimensions and weight

Description	Value
Height	113.20 mm (4.46 in.)
Width	90.50 mm (3.56 in.)
Depth	117.35 mm (4.62 in.)
Weight	0.67 kg (1.48 lb)

Docking specifications

Table 10. Operating and storage environment

Description	Operating	Non-operating
Temperature range	0 °C – 35 °C (32 °F – 95 °F)	Non-operating : -20 °C to 60 °C (-4 °F to 140 °F)
Relative humidity (maximum)	10% to 80% (non-condensing)	Non-operating : 5% to 90% (non-condensing)
 WARNING: Operating and storage temperature ranges may differ among components, so operating or storing the device outside these ranges may impact the performance of specific components.		

Dell docking station firmware update

Standalone Dock Firmware Update utility

NOTE: Information that is provided is for Windows users running the executable tool. For other operating systems or further detailed instructions see the HD22Q admin guide available on www.dell.com/support.

Download the Dell HD22Q dock driver and firmware update from www.dell.com/support. Connect the dock to the system and start the tool in administrative mode.

1. Wait for all the information to be entered in the various Graphical User Interface (GUI) panes.

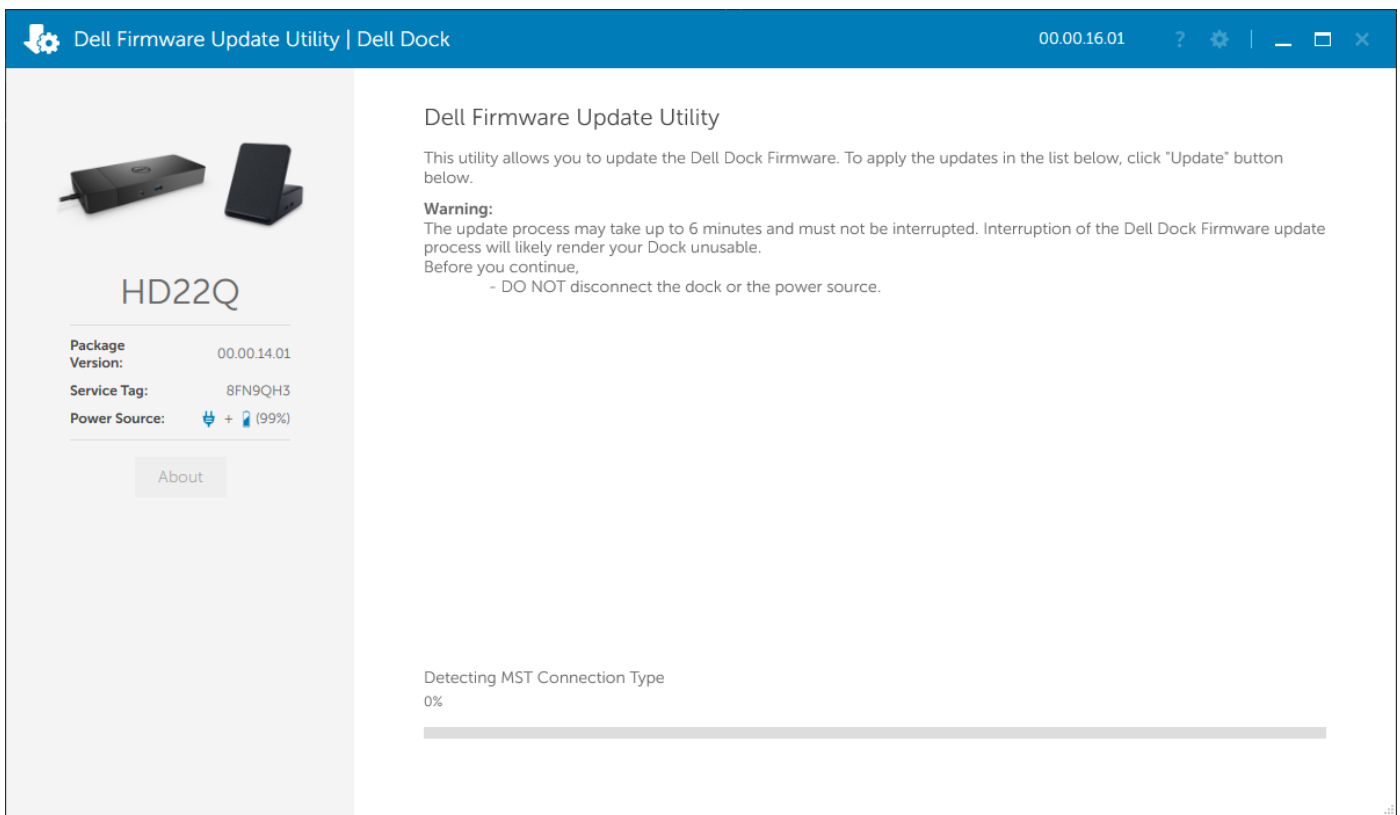

2. **Update** and **Exit** buttons are displayed in the bottom-right corner. Click the **Update** button.

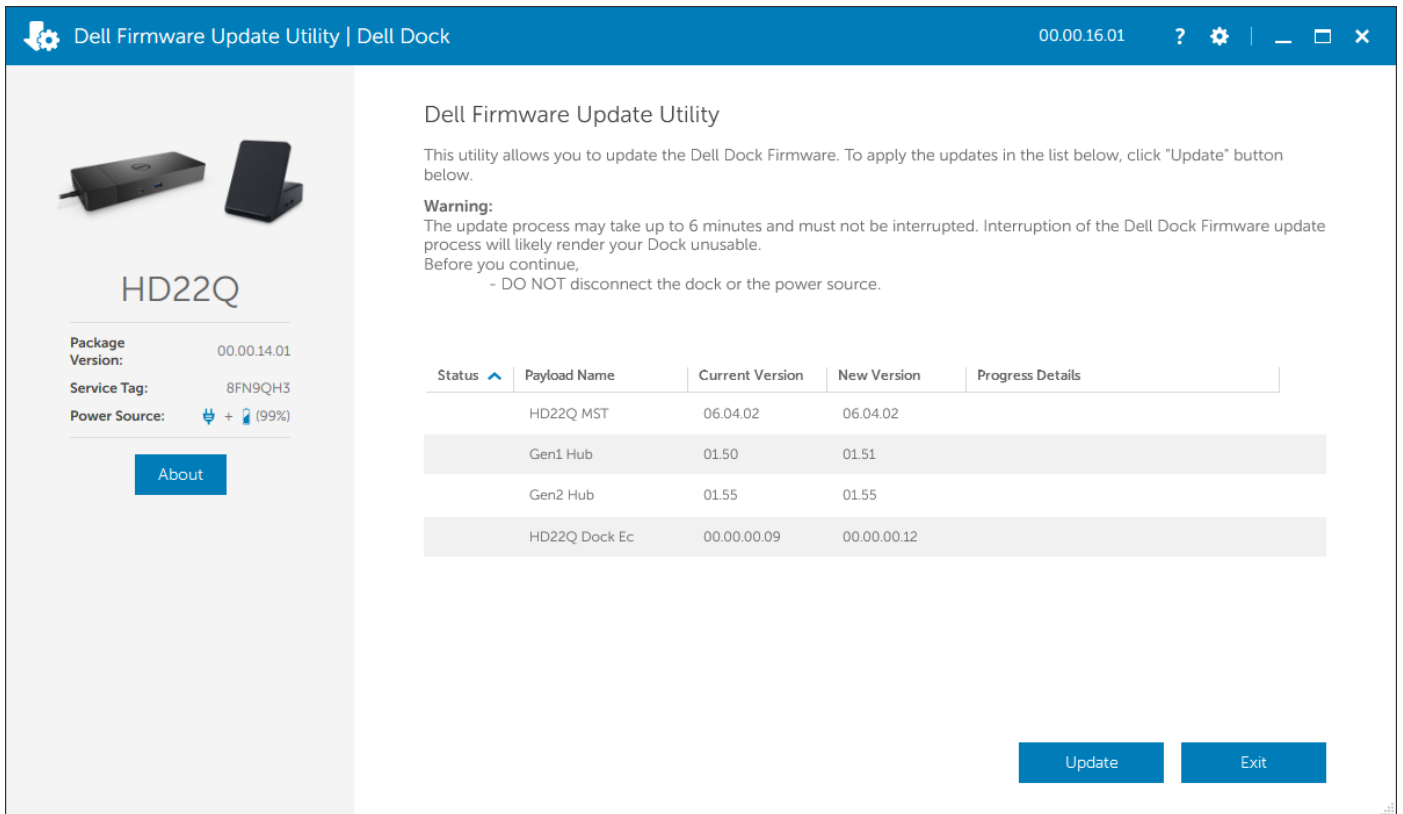

3. Wait for all the component firmware update to complete. A progress bar is displayed in the bottom.

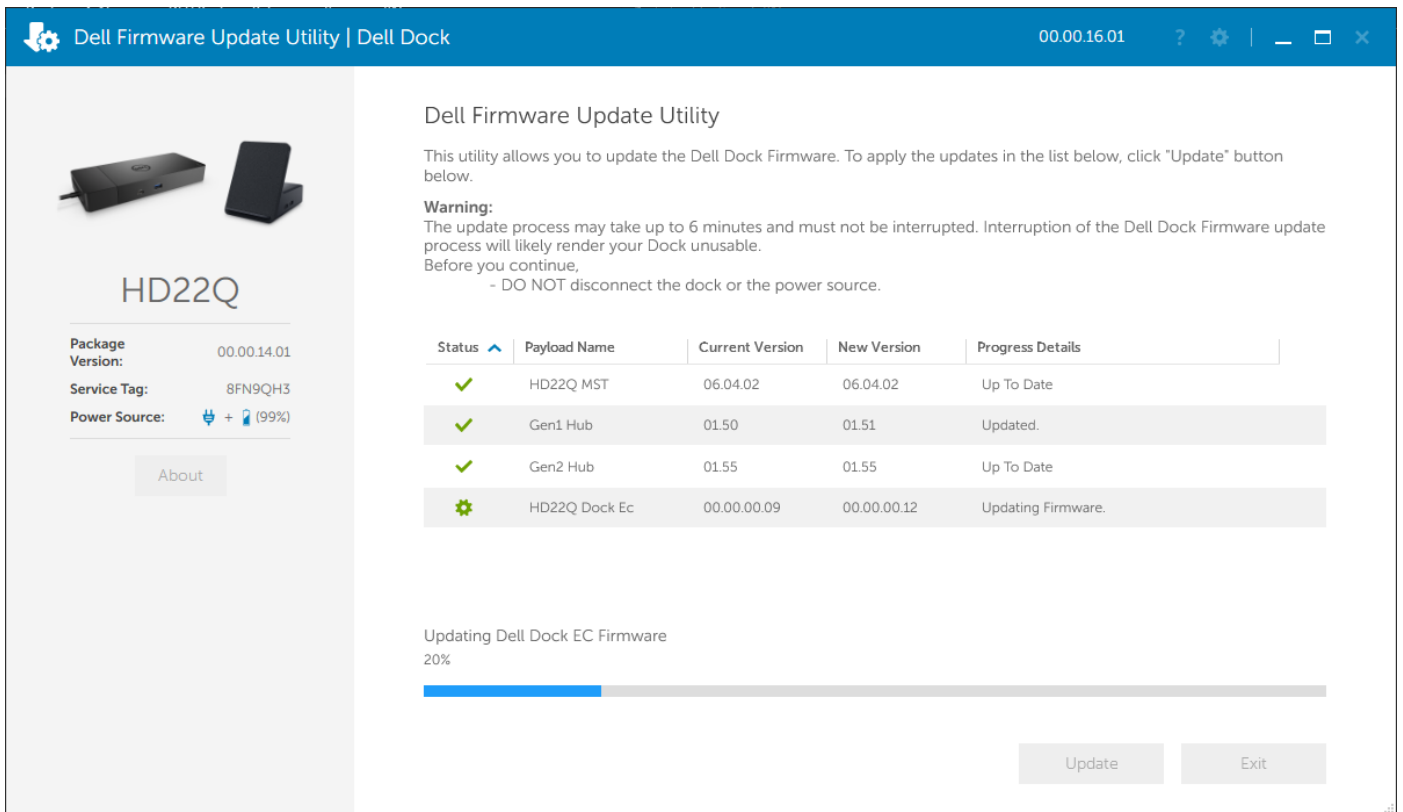

4. The update status is displayed above the payload information.

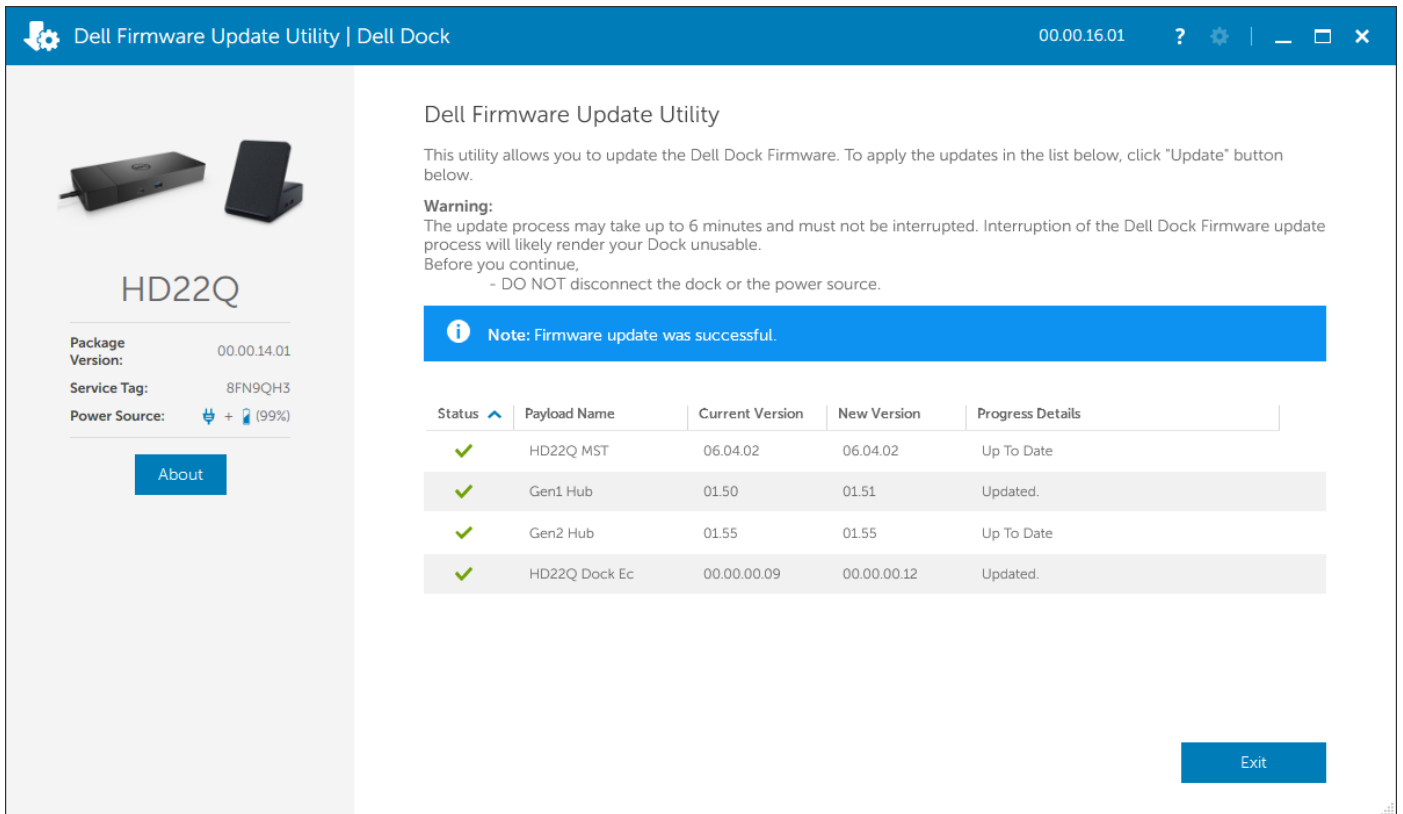

Table 11. Command-Line Options

Command lines	Function
/? or /h	Usage.
/s	Silent.
/l=<filename>	Log file.
/verflashexe	Display utility version.
/componentsvers	Display current version of all dock firmware components.

For IT professionals and engineers, to get more information about the following technical topics, see the Dell Docking Station Admin's Guide:

- Step-by-step standalone DFU (Dock Firmware Update) and driver update utilities.
- Using DCU (Dell Command | Update) for driver download.
- Dock asset management locally and remotely through DCM (Dell Command | Monitor) and SCCM (System Center Configuration Manager).

Troubleshooting the Dell Dual Charge Dock - HD22Q

Symptoms and solutions

Table 12. Symptoms and solutions

Symptoms	Suggested solutions
1. No video on the monitors attached to the High Definition Multimedia Interface (HDMI), or DisplayPort (DP) port on the docking station	<ul style="list-style-type: none"> • Ensure that the latest BIOS and drivers for your computer and the docking station are installed on your computer. • Ensure your computer is connected to the docking station securely. Try to disconnect and reconnect the docking station to the notebook computer. • Disconnect both ends of the video cable and check for damaged/bent pins. Securely reconnect the cable to the monitor and docking station. • Ensure the video cable (HDMI, or DisplayPort) is connected properly to the monitor and the docking station. Ensure to select the correct video source on your monitor (refer to your monitor's documentation for more information about changing the video source). • Check the resolution settings on your computer. Your monitor may support higher resolutions than what the docking station is able to support. Please see the Display Resolution Table for more information about maximum resolution capacity. • If your monitor is connected to the docking station, the video output on your computer may be disabled. You can enable the video output using the Intel Graphics Control Panel or refer to the User Guide of your computer. • If only one monitor is shown, while the other is not, go to Windows Display Properties, and under Multiple Displays, select the output for the second monitor. • Using Intel graphics and using the system LCD, only two displays can be supported. • For Nvidia or AMD discrete graphics, the dock supports three external displays plus the system LCD. • Try with a different monitor and cable that is known to be good, if possible.
2. The video on the attached monitor is distorted or flickering	<ul style="list-style-type: none"> • Reset the monitor to Factory Defaults. Refer to the User Guide of your monitor for more information about how to reset the monitor to factory defaults. • Ensure that the video cable (HDMI or DisplayPort) is connected securely to the monitor and the docking station. • Disconnect and reconnect the monitor(s) from the docking station. • First power off the docking station by disconnecting the Type-C cable and then removing the power adapter from the dock. Then, power on the docking station by connecting power adapter to the dock before connecting the Type-C cable to your computer.

Table 12. Symptoms and solutions (continued)

Symptoms	Suggested solutions
	<ul style="list-style-type: none"> ● Disconnect the dock and reboot the system if, the above steps do not work.
<p>3. The video on the attached monitor is not displaying as an Extended Monitor</p>	<ul style="list-style-type: none"> ● Ensure that the Intel HD Graphics driver is installed in the Windows Device Manager. ● Ensure that the Nvidia or AMD Graphics driver is installed in the Windows Device Manager. ● Open the Windows Display Properties and go to Multiple Displays control to set the display to the extended mode.
<p>4. The USB ports are not functioning on the docking station</p>	<ul style="list-style-type: none"> ● Ensure that the latest BIOS and drivers for your computer and the docking station are installed. ● If your BIOS Setup has a USB Enabled/Disabled option, ensure it is set to Enabled. ● Verify if the device is detected in Windows Device Manager and that the correct device drivers are installed. ● Ensure that the docking station is connected securely to the notebook computer. Try to disconnect and reconnect the docking station to the computer. ● Check the USB ports. Try plugging the USB device into another port. ● First power off the docking station by disconnecting the Type-C cable and then removing the power adapter from the dock. Then, power on the docking station by connecting the power adapter to the dock before connecting the Type-C cable to your computer.
<p>5. The High-Bandwidth Digital Content Protection (HDCP) content is not displayed on the attached monitor</p>	<ul style="list-style-type: none"> ● Dell Dock supports HDCP upto HDCP 2.2. <p> NOTE: User's monitor/display must support HDCP 2.2</p>
<p>6. The LAN port is not functioning</p>	<ul style="list-style-type: none"> ● Ensure that the latest BIOS and drivers for your computer and the docking station are installed on your computer. ● Ensure that the Ethernet Controller driver is installed in the Windows Device Manager. ● If your BIOS Setup has a LAN/GBE Enabled/Disabled option, ensure it is set to Enabled ● Ensure that the Ethernet cable is connected securely on the docking station and the hub/router/firewall. ● Check the status LED of the Ethernet cable to confirm connectivity. Reconnect both ends of the Ethernet cable if the LED is not lit. ● First power off the docking station by disconnecting the Type-C cable and then removing the power adapter from the dock. Then, power on the docking station by connecting the power adapter to the dock before connecting the Type-C cable to your computer.
<p>7. USB port has no function in a pre-OS environment</p>	<ul style="list-style-type: none"> ● Check the BIOS > Integrated Devices for USB Configuration options, and ensure the following options are checked: <ul style="list-style-type: none"> ● 1. Enable USB Boot Support ● 2. Enable External USB Port
<p>8. PXE boot on dock does not function</p>	<ul style="list-style-type: none"> ● Check the BIOS > System Management for integrated NIC options, and select Enabled w/PXE. ● If your BIOS Setup on your computer has a USB Configuration page, please ensure the following options are checked: <ul style="list-style-type: none"> ● 1. Enable USB Boot Support

Table 12. Symptoms and solutions (continued)

Symptoms	Suggested solutions
9. USB Boot does not function	<ul style="list-style-type: none"> ● If your BIOS has a USB Configuration page, please ensure the following options are checked: ● 1. Enable USB Boot Support ● 2. Enable External USB Port
10. AC Adapter is displayed as “Not Installed” in the Battery Information page of the Dell BIOS Setup when the Type-C cable is connected	<ol style="list-style-type: none"> 1. Ensure the dock is connected properly to its own adapter (130 W). 2. Disconnect and reconnect the dock's power adapter. 3. Disconnect and then reconnect the Type-C cable to your computer.
11. Peripherals connected to the docking station do not work in a pre-OS environment	<ul style="list-style-type: none"> ● If the BIOS Setup on your computer has a USB Configuration page, check the following options to enable docking station function in a pre-OS environment: ● Enable External USB Port
12. Alert message “You have attached an undersized power adapter to your system or Undersized adapter” is displayed when the docking station is connected to your computer	<ul style="list-style-type: none"> ● Ensure the docking station is connected properly to its own power adapter. Computers that require more than 90 W power input must also be connected to their own power adapter for charging and optimal performance.
13. Undersized power adapter warning message displayed	<ol style="list-style-type: none"> 1. Ensure the dock is connected properly to its own adapter (130 W). 2. Disconnect and reconnect the dock's power adapter. 3. Disconnect and then reconnect the Type-C cable to your computer.
14. No external display. Dock's USB ports are not responding	<ul style="list-style-type: none"> ● The docking connector has disconnected from the system's USB ports. Please reconnect the docking connector. ● Undock and reboot the system if the above steps do not work.
15. With Ubuntu 18.04 LTS, WIFI will be turned off when the docking station is connected to the system and the WIFI turns On again after rebooting the system.	<ul style="list-style-type: none"> ● Please uncheck the option Control WLAN radio in BIOS. ● Option is available in - Settings -> Power Management -> Wireless Radio Control
16. When the dock has no power	<ul style="list-style-type: none"> ● Disconnect USB Type-C from the system and the dock's power adapter. ● Reconnect the dock's AC adapter. ● Check if the dock LED is on.
17. When the dock is not working even when BIOS, firmware and drivers are up to date.	<ul style="list-style-type: none"> ● Reconnect the dock's AC adapter ● Restart the dock ● Attempt flashing the firmware on the dock. ● Check if the power LEDs on the dock are functional.
18. Wireless charging does not work	<ul style="list-style-type: none"> ● Ensure that your device supports wireless charging. ● Reconnect the dock's AC adapter. ● Restart the dock. ● Check if the wireless device is placed properly on the charging pad of the dock. ● Check if the power LEDs on the dock are functional.
19. Qi charging LED flashes amber	<p>This LED blinks amber when the dock detects an abnormal charging status such as FOD (Foreign Object Detection) or OTP (Over Temperature Protection).</p> <p>FOD (Foreign Object Detection):</p>

Table 12. Symptoms and solutions (continued)



Symptoms	Suggested solutions
	<ol style="list-style-type: none"> 1. Check if there are any metal objects in between the charging pad and the mobile device. 2. Check if the error goes away after removing the phone case. It is also not recommended to use thick phone cases, metal finished cases, battery cases, coins or bank cards placed inside the phone cover etc. when charging your device. 3. Once cleared, the LED should switch back to solid white indicating that the device is charging. <p>OTP (Over Temperature Protection):</p> <ol style="list-style-type: none"> 1. Check if the mobile device is heating up. 2. Take the phone off the charging pad and place it away to let it cool down. 3. Once cooled sufficiently, please the phone on the charging pad and observe the LED. 4. The LED should switch back to a steady white indicating that the device is charging.
<p>20. Device placed on wireless charging pad is charging slower than usual</p>	<p>If the battery on the charging device gets too warm, the device might limit the wireless charging speed. However, it should start charging normally once the temperature drops:</p> <ol style="list-style-type: none"> 1. Check if the device is overheating. 2. Remove the device from the charging pad and allow it to cool down. 3. Move the dock and the device to a cooler location.
<p>21. Device placed on the wireless charging pad charges intermittently</p>	<p>The dock has a 3-coil design to support different size devices. Also, the dock only supports wireless charging on one device at a time:</p> <ol style="list-style-type: none"> 1. Find the position that works best for your device. Refer to Orientations supported for wireless charging. 2. Check if the Qi charging LED stays on after the device is placed on the charging pad to confirm.

Getting help and contacting Dell

Self-help resources

You can get information and help on Dell products and services using these self-help resources:

Table 13. Self-help resources

Self-help resources	Resource location
Information about Dell products and services	www.dell.com
My Dell app	
Tips	
Contact Support	In Windows search, type <code>Contact Support</code> , and press Enter.
Online help for operating system	www.dell.com/support/windows
Access top solutions, diagnostics, drivers and downloads, and learn more about your computer through videos, manuals and documents.	Your Dell computer is uniquely identified by a Service Tag or Express Service Code. To view relevant support resources for your Dell computer, enter the Service Tag or Express Service Code at www.dell.com/support . For more information on how to find the Service Tag for your computer, see Locate the Service Tag on your computer .
Dell knowledge base articles for a variety of computer concerns	<ol style="list-style-type: none"> 1. Go to www.dell.com/support. 2. On the menu bar at the top of the Support page, select Support > Knowledge Base. 3. In the Search field on the Knowledge Base page, type the keyword, topic, or model number, and then click or tap the search icon to view the related articles.

Contacting Dell

To contact Dell for sales, technical support, or customer service issues, see www.dell.com/contactdell.

 **NOTE:** Availability varies by country/region and product, and some services may not be available in your country/region.

 **NOTE:** If you do not have an active Internet connection, you can find contact information about your purchase invoice, packing slip, bill, or Dell product catalog.