

NetShelter® Rack PDU Advanced

User Guide

February 2022



Legal Information

The Schneider Electric brand and any trademarks of Schneider Electric SE and its subsidiaries referred to in this guide are the property of Schneider Electric SE or its subsidiaries. All other brands may be trademarks of their respective owners.

This guide and its content are protected under applicable copyright laws and furnished for informational use only. No part of this guide may be reproduced or transmitted in any form or by any means (electronic, mechanical, photocopying, recording, or otherwise), for any purpose, without the prior written permission of Schneider Electric.

Schneider Electric does not grant any right or license for commercial use of the guide or its content, except for a non-exclusive and personal license to consult it on an "as is" basis. Schneider Electric products and equipment should be installed, operated, serviced, and maintained only by qualified personnel.

As standards, specifications, and designs change from time to time, information contained in this guide may be subject to change without notice.

To the extent permitted by applicable law, no responsibility or liability is assumed by Schneider Electric and its subsidiaries for any errors or omissions in the informational content of this material or consequences arising out of or resulting from the use of the information contained herein.

Table of Contents

Introduction	5
Product Features	5
Types of User Accounts	6
Establish Network Settings	6
Local Serial Connection	7
Assign a Static IP Address	8
Assign DHCP IP Addresses From Static Mode	10
Front Panel Overview	11
Display Menus	12
Web User Interface (Web UI)	16
Supported Web Browsers	16
Navigating the Web UI	18
The Home Menu	19
View Logs	23
Settings	24
System Management	28
Setup Email	33
Event Notifications	34
Configure the Trap Receiver	35
Defining Rack PDU Thresholds	36
User Settings	42
SNMP	50
Using an MIB Browser	50
Redfish	52
Redfish URLs Supported with GET Method	54
The Command Line Interface (CLI)	57
CLI Commands and Prompts	57
CLI System Commands	58
CLI Network Commands	58
CLI User Commands	60
CLI Device Commands	60
CLI Power Commands	61
Cascading Rack PDUs and Redundant Network Access (RNA)	62
Firmware Update Procedures	64
Update Using USB	64
Update Using the Web UI	64
Update Using FTPS	65
Troubleshooting	66
Rack PDU Access Problems	66
SNMP Issues	66
Source Code Copyright Notice	67

Introduction

Product Description

The NetShelter Rack PDU Advanced is an efficient and reliable power distribution system with color-coded circuit breakers and power outlet options to customize the equipment according to your requirements. The NetShelter Rack PDU Advanced is available in Metered, Switched, Metered-by-Outlet, and Metered-by-Outlet with Switching styles.

Product Features

The NetShelter Rack PDU Advanced may be used as a stand-alone, network manageable power distribution device or up to 32 devices can be connected together using one network connection. You can manage a NetShelter Rack PDU Advanced through its Web User Interface (UI), its Command Line Interface (CLI), Redfish (through an app such as POSTMAN), or from the Rack PDU's display interface.

- Network management and alerting capabilities supporting HTTP, HTTPS, SSH, SNMP, and email.
- Strong encryption, passwords, and advanced authorization options including local permissions, LDAP/S, and Active Directory.
- Cascade the Rack PDUs: Guest Rack PDUs can be connected to a single Host Rack PDU. Up to 32 Rack PDUs of the same SKU can be connected in series.
- Each Rack PDU can support a maximum of eight (8) environmental sensors.
- The Power Sharing feature allows for uninterrupted network communication and sensor function in the event of input power loss.
- Depending on the Rack PDU model, the following features are provided:
 - Inlet Power Measurement
 - Outlet Power Measurement
 - Outlet Switching Capability
- Single Phase Rack PDUs are provided with hydraulic magnetic breakers that are color-coded to match their corresponding outlets.
- Three Phase, 208V, Rack PDUs use circuit breakers color coordinated to correspond to the line connections and include a label of the two connected input phases (L1–L2, L2–L3, L3–L1).
- Three Phase, 400V~415V, Rack PDUs use circuit breakers and outlets color coordinated to the appropriate input phase (L1–N, L2–N, L3–N). The Rack PDU is labeled to indicate the input-phase associated with each circuit breaker and its associated outlets.
- All Three Phase Rack PDUs rated above 16A and 20A will use a three (3) color coding system (dark gray, light gray, and white).
- The Rack PDUs are equipped with a Live Swappable NMC Module which eliminates the need to power down the Rack PDU and connected loads during replacement.
- Toolless mounting pegs allow for mounting in most racks from the rear or side of the Rack PDU.
- The USB port on the display panel allows for file downloads to a USB flash drive and for local firmware upgrades
- Switched Rack PDUs features:
 - Individual outlet control
 - Configurable power On or Off delays
- Multiple login feature which allows up to sixteen (16) users to be logged in simultaneously.
- Configurable alarm thresholds that provide network and visual alarms to help avoid overloaded circuits.
- Email notifications for system events.

Types of User Accounts

A total of sixteen (16) user accounts can be created. All sixteen (16) users can be logged in at the same time but for maximum performance three (3) users are recommended.

The default setting has three (3) accounts: one user, one manager, one admin.

Thirteen (13) additional users can be added.

- admin: has all privileges including Redfish
- manager: has all privileges including Redfish (This user level is intended for management of Redfish API)
- user: read-only access

Establish Network Settings

NOTE: If the Rack PDU is placed within a static network environment, users can configure the Rack PDU to a Static IP address by connecting the Rack PDU by serial cable to your computer or by uploading a configuration file using the USB port on the display interface. See those topics in this manual for more information.

Establish a Network Connection

Rack PDUs are set to obtain an IP address using DHCP by default. When the Rack PDU is connected to a network for the first time, the Rack PDU will automatically obtain an IP address.

1. Connect a standard Ethernet cable to Port 1 or Port 2 on the Rack PDU.
2. Connect the other end of the cable to your Network (LAN).
3. A solid green light on the left side and a flashing yellow light on the right side of the Port will indicate successful connectivity to the network.

Obtain the IP Address from the Rack PDU

On the Rack PDU display, navigate through the menus to obtain the IP address (IPv4 or IPv6 as applicable).

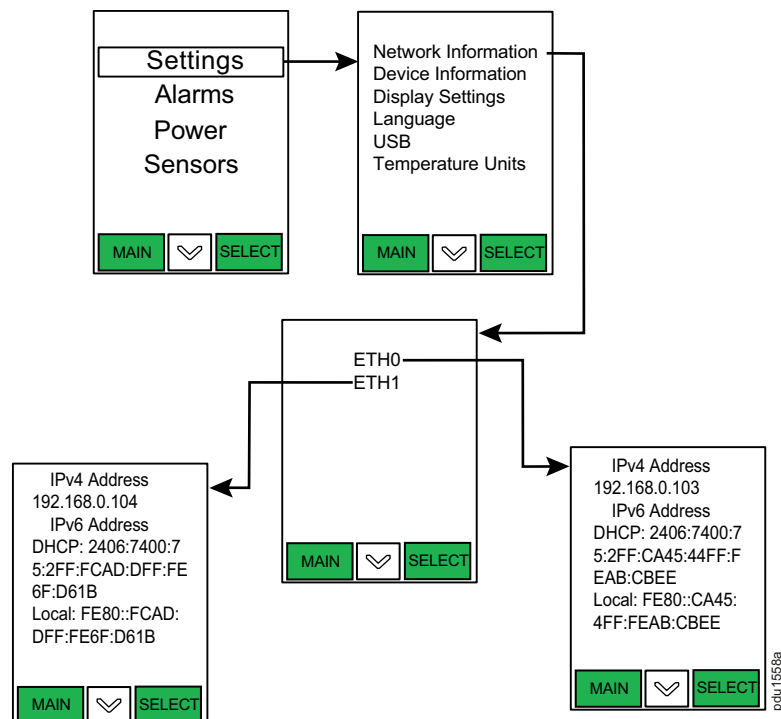

To login to the Web UI, in a standard web browser, enter the IP address you obtained from the Rack PDU:

`https://IP address`

The login page for the Web UI will open.

NOTE: You can also use the IP address to login to the Rack PDU using the CLI.

Local Serial Connection

You can configure the network settings using the Command Line Interface (CLI) with a serial connection. You can either connect serially using the optional Schneider Electric RJ45–DB9 Cable, 940–0144A (recommended) or by creating a unique pinout.

1. Connect the RJ45 end of the serial cable into the Port 1 on the Rack PDU.
2. Connect the DB9 end of the cable into the communications (COM) port on your computer.

NOTE: You can use a DB9–serial-to-USB connection cable for this step to connect to the USB if a DB9 serial port is not available on your computer.

3. Open a communications program such as HyperTerminal or PUTTY.

Select the **COM** port. Set the communications port as follows:

- Speed (baud) Bits per second: 115200
- Data bits: 8
- Stop bits: 1
- Parity: None
- Flow Control: None

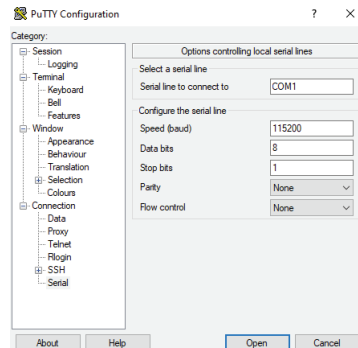

4. Use the default initial login indicated below.

NOTE: Username and Password are both case sensitive.

- Username: admin
- Password: 12345678

NOTE: For security, following your initial login, you will be prompted to change your password.

5. The **apc>** prompt appears after you have logged in.
6. To configure network settings, type the appropriate commands in the command prompt and press the Enter key. All commands are case sensitive.

NOTE: You can type “?” to access a list of all available commands.

Creating a Unique Pinout Connection

To create your own pinout connection for the RJ45 to Serial cable, make the wiring connections as shown:

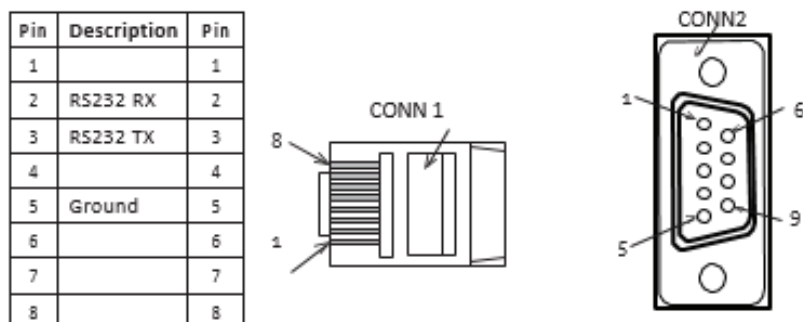

Assign a Static IP Address

You can assign a static IP address using the CLI.

To assign a static IPv4 address, configure the below parameters:

```
net tcpip eth0static x.x.x.x (ipaddress) x.x.x.x (netmask) x.x.x.x (gateway)
```

```
Example: net tcpip eth0static 192.168.1.100 255.255.255.0 192.168.1.1
```

To assign a static IP address to Port 1 of the Rack PDU using the CLI:

```
apc>net tcpip
```

```
SUCCESS
```

```
eth0 IPv4 Addr: 192.168.0.103
```

```
eth0 IPv6 Link Local Addr: fe80::ca45:44ff::feab:cbee
```

```
eth0 IPv6 DHCP Addr: 2406:7400:75:2ff:ca45:44ff:feab:cbee
```

```
eth1 IPv4 Addr: 192.168.0.104
```

```
eth1 IPv6 Link Local Addr: fe00::fcad:dff:fe6f:d61b
```

```
eth1 IPv6 DHCP Addr: 2406:7400:75:2ff:fcad:dff:fe6f:d61b
```

```
apc>net tcpip eth0static 192.168.0.200 255.255.255.0 192.168.0.1
```

```
Reboot required for change to take effect
```

```
Network is reconfigured, Please reboot to validate
```

```
System Reboot now, Are you sure? (Y/N) :Y
```

To assign a static IP address to Port 2 of the Rack PDU using the CLI:

```
apc>net tcpip
```

```
SUCCESS
```

```
eth0 IPv4 Addr: 192.168.0.200
```

```
eth0 IPv6 Link Local Addr: fe80::ca45:44ff::feab:cbee
```

```
eth0 IPv6 DHCP Addr: 2406:7400:75:2ff:ca45:44ff:feab:cbee
```

```
eth1 IPv4 Addr: 192.168.0.105
```

```
eth1 IPv6 Link Local Addr: fe80::6453:31ff:fe36:60e9
```

```
eth1 IPv6 DHCP Addr: 2406:7400:75:2ff:6453:31ff:fe36:60e9
```

```
apc>net tcpip eth1static 192.168.0.199 255.255.255.0 192.168.0.1
```

```
Reboot required for change to take effect
```

```
Network is reconfigured, Please reboot to validate
```

```
System Reboot now, Are you sure? (Y/N) :Y
```

After static IP addresses have been assigned to both ports, the CLI response will appear similar to the below example when queried:

```
apc>net tcpip
```

```
SUCCESS
```

```
eth0 IPv4 Addr: 192.168.0.200
```

```
eth0 IPv6 Link Local Addr: fe80::ca45:44ff:feab:cbee
```

```
eth0 IPv6 DHCP Addr: 2406:7400:75:2ff:ca45:44ff:feab:cbee
```

```
eth1 IPv4 Addr: 192.168.0.199
```

```
eth1 IPv6 DHCP Addr: 2406:7400:75:2ff:380f:9dff:fe91:f55f
```

```
apc>
```

The Web UI can now be accessed after the static IP addresses are assigned.

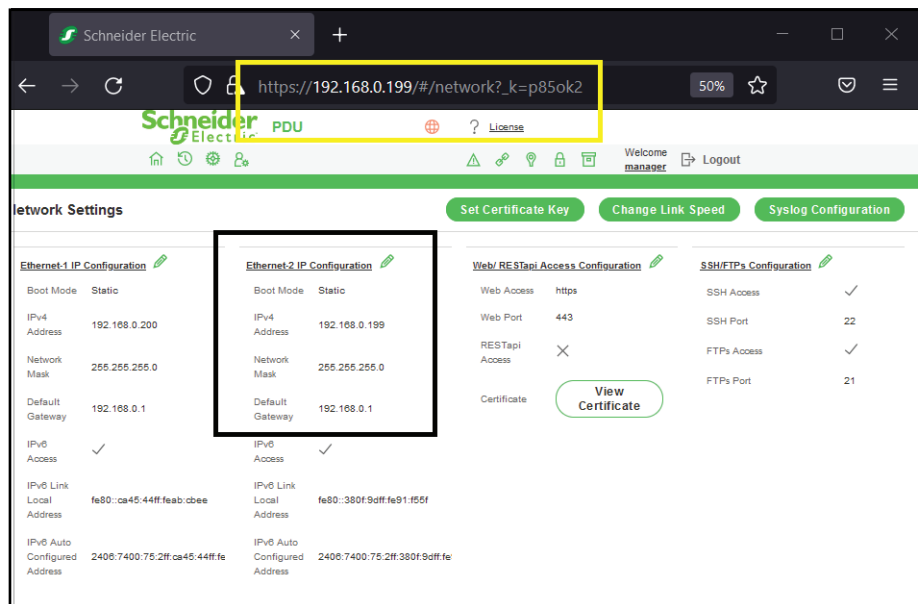
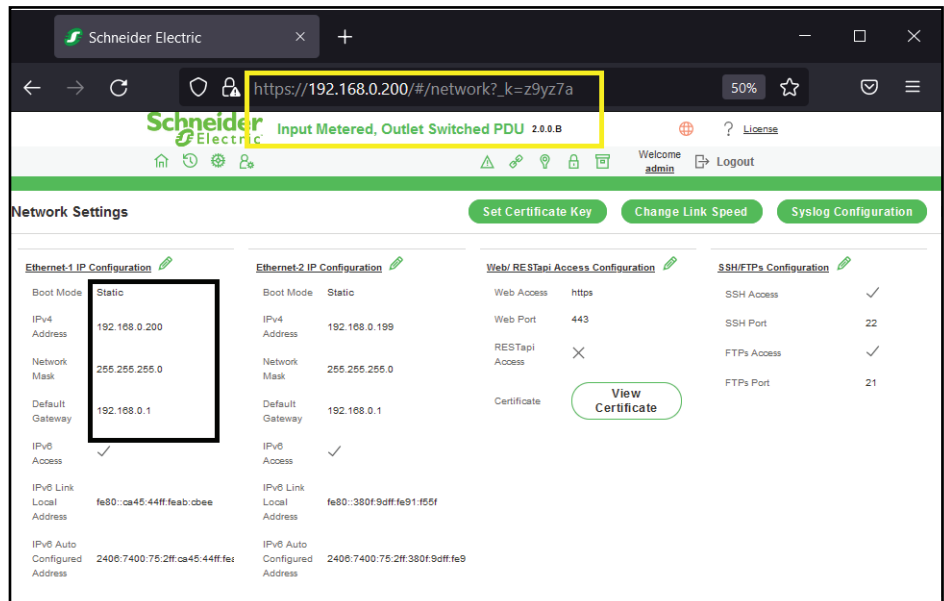

Static IP addresses assigned using CLI for Port 1 and Port 2 will appear on the LCD display of the Rack PDU similar to the below example:

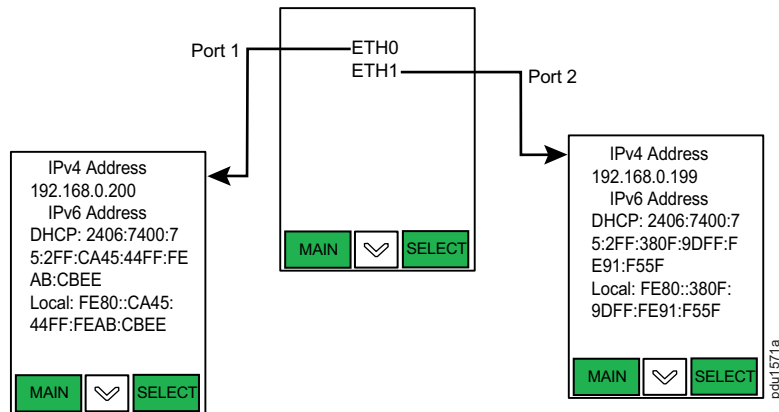

Assign DHCP IP Addresses From Static Mode

You can change from Static mode to DHCP mode using the CLI to assign DHCP IP Addresses for Port 1 and Port 2 of your Rack PDU.

To change to DHCP mode from static mode for Port 1:

Type: `net tcpip eth0dhcp`

The CLI response:

```
Reboot required for change to take effect
Network is reconfigured, Please reboot to validate
System Reboot now, Are you sure? (Y/N) :
```

Type: `Y` to confirm.

The Reboot will start.

To change to DHCP mode from static mode for Port 2:

Type: `net tcpip eth1dhcp`

The CLI response:

```
Reboot required for change to take effect
Network is reconfigured, Please reboot to validate
System Reboot now, Are you sure? (Y/N) :
```

Type: `Y` to confirm.

The Reboot will start.

To see the DHCP IP addresses, type: `net tcpip`

The CLI response:

```
SUCCESS
eth0 IPv4 Addr: 192.168.0.103
eth0 IPv6 Link Local Addr: fe80::ca45:44ff:feab:cbee
eth0 IPv6 DHCP AddrP 2406:7400:75:2ff:ca45:44ff:feab:cbee
eth1 IPv4 Addr: 192.68.0.107
eth1 IPv6 Link Local Addr: fe80::1ccf:3fff:fe3c:755f
eth1 IPv6 DHCP Addr: 2406:7400:75:2ff:1ccf:3fff:fe3c:755f
```

Front Panel Overview

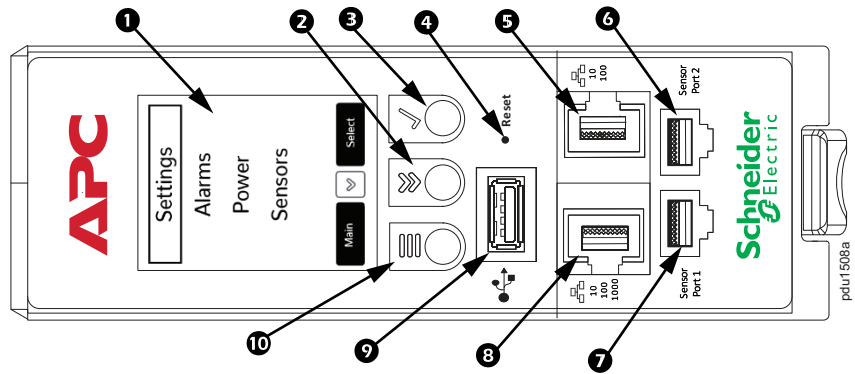

Item	Description	Function
1	Display Panel	Shows information about the Rack PDU.
2	Scroll button	Press once to display the menu. Press additional times to move the highlight bar down the menu list until you reach the desired item.
3	Select button	With the menu item highlighted, press the Select button to display the Rack PDU information.
4	Reset	Resets the network management interface without affecting outlets of the Rack PDU.
5	10/100 Network port	Redundant Ethernet and Cascading with DC Power Share. Connects the Rack PDU to the network using a Cat5e network cable.
6	Sensor port 2	Port for connecting an optional sensor. Also for use as a Serial connection port.
7	Sensor port 1	Port for connecting an optional sensor.
8	10/100/1000 Network port	Gigabit Ethernet port. Connects the Rack PDU to the network. Connects the Rack PDU to another Rack PDU in a cascading group with DC Power Share, using a Cat5e network cable.
9	USB port	For use with a flash drive for firmware upgrades. Can also be used to download log files to a flash drive.
10	Menu button	Press to view MENU information or navigate back to the previous screen.

Display Tree — Example 1

The display on your Rack PDU provides information about the Rack PDU and its connected devices. The Main Menu and its immediate submenus are shown below.

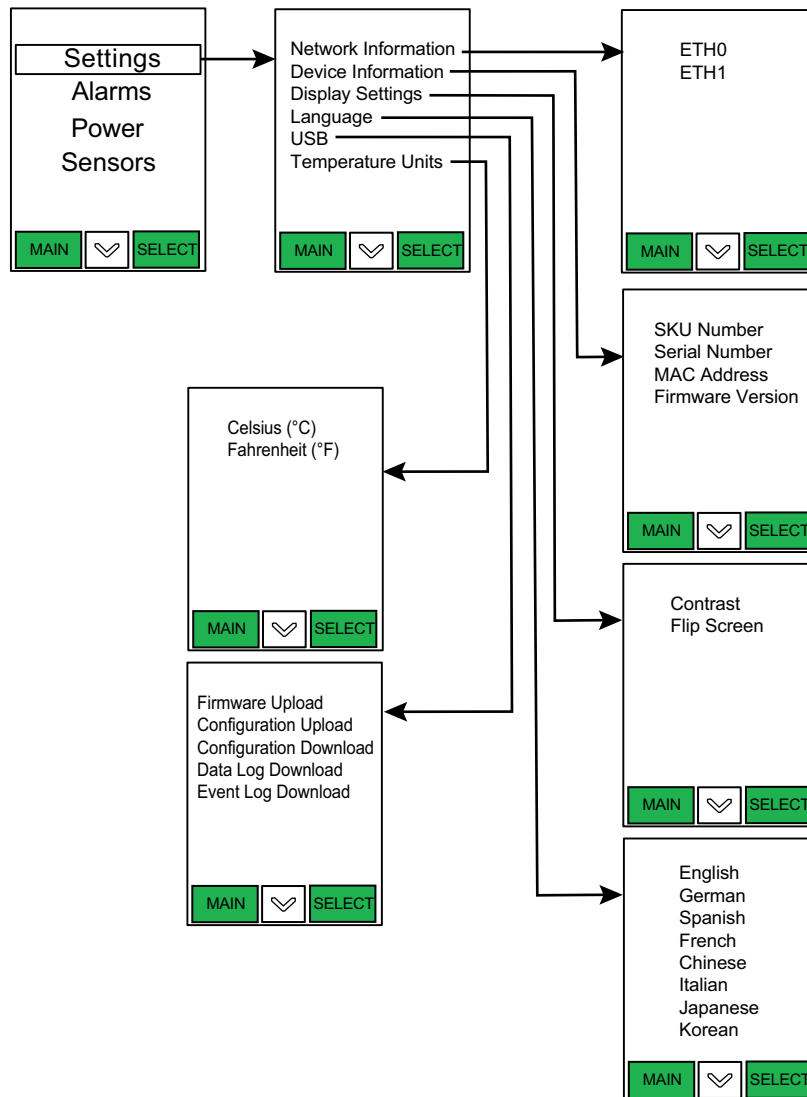

Display Menus

The display menus provide user configuration options and information regarding Network, Device, Display, Language, USB, and Temperature Units. On the Main Menu screen, scroll down to highlight Settings. Press the Select button to open the submenu. Scroll down to highlight a submenu option. Press the Select button to open that option's screen. You can press the Main (Menu) button to return to the previous menu screen.

Network Submenu

The Network submenu allows you to view the IP address for IPv4 or IPv6.

Settings>Network>ETH0

Settings>Network>ETH1

On the Settings menu, scroll down to Network. Press Select to enter the Network Submenu. Scroll down to highlight the selected option from the menu. Press Select to display the screens that display the IP address. Press Main to return to the previous menu.

Device Information Submenu

The Device Information submenu provides details regarding the SKU, Serial number, MAC address, and firmware version.

Settings>Device Information>SKU Number

Settings>Device Information>Serial Number

Settings>Device Information>MAC Address

Settings>Device Information>Firmware Version

On the Settings menu, scroll down to highlight Device Information. Press Select to open the Device Information submenu. Scroll down to the item you wish to display and press Select. Press Main to return to the previous menu.

Display Settings Submenu

The Display Settings submenu allows you to customize settings for the display.

The Display Settings options are:

Settings>Display Settings>Contrast

Settings>Display Settings>Flip Screen

On the Settings menu, scroll down to highlight Display Settings. Press Select to select the Display Settings submenu. Press Main to return to the previous menu.

Language Submenu

The Language submenu allows the user to view the display in 8 languages.

Settings>Language>English

Settings>Language>German

Settings>Language>Spanish

Settings>Language>French

Settings>Language>Chinese

Settings>Language>Italian

Settings>Language>Japanese

Settings>Language>Korean

On the Settings menu, scroll down to highlight Language. Press Select to display the Language submenu. After you select the language, press Select to set the language as displayed on the screen. Press Main to return to the previous menu.

USB Submenu

The USB submenu allows you to upload Firmware and Configuration files. It also enables the user to download an Event or Data Log.

Settings>USB>Firmware Upload

Settings>USB>Configuration Upload

Settings>USB>Configuration Download

Settings>USB>Data Log Download

Settings>USB>Event Log Download

On the Settings menu, scroll down to highlight USB. Press Select to enter the USB submenu. Select the desired function from the USB submenu. The user will be asked to verify the USB operation and Configuration Mode. After you select Yes, the system will reboot into the USB operation and Configuration mode. Press Main to return to the previous menu.

NOTE: If a USB drive is not present in the USB slot the PDU will enter normal operation.

NOTE: If you are in USB mode and you want to exit USB mode, you must remove the USB drive before exiting USB mode. Otherwise, the PDU will reboot and re-enter USB mode.

Temperature Units Submenu

The Temperature Units submenu displays the temperature units.

Settings>Temperature Units> Celsius (°C)

Settings>Temperature Units> Fahrenheit (°F)

On the Settings menu, scroll down to highlight the Temperature Units. Press Select to enter the Temperature Units Submenu. After you select the values, press Select to set the values as displayed on the screen. Press Main to return to the previous menu.

NOTE: This can only be done locally at the PDU.

Alarms Menu

The Alarms menu displays active alarms of the PDU. On the Main Menu, scroll down to highlight Alarms. Press Select to display the Alarm Screen. When you finish your review, press Main to return to the previous screen.

Power Menu

Use the Power menu to view Breaker, Phase and Outlet Information. It allows for management of Guest Device Status.

On the Main Menu, scroll down to highlight Power. Press Select to enter the Power menu. Scroll down to select a submenu and press Select to display the submenu options. Press Main to return to the previous menu.

Device Status Submenu

The Device Status submenu displays Current, Voltage, Energy and Power of the respective Rack PDU.

Power>Device Status

On the Power menu, scroll down to highlight Device Status. Press Select to display the information. Press Main to return to the previous menu.

Phase Information Submenu

The Phase submenu is to display the status and information of 3–Phase lines.

Power>Phase Information

On the Power menu, scroll down to highlight Phase Information. Press Select to display the Phase Information submenu. Press Main to return to the previous menu.

Guest Status Submenu

The Guest Status submenu displays Current, Voltage, Energy and Power of the Guest PDU.

Power>Guest Status

On the Power menu, scroll down to highlight Guest Status. Press Select to display the information. To navigate through the different Guest Rack PDUs, press the Scroll button. Press Main to return to the previous menu.

Breaker Information Submenu

The Breaker Information submenu is to display the status and information for the circuit breakers.

Power>Breaker Information

On the Power menu, scroll down to highlight Breaker information. Press Select to display the information. To navigate through the different Circuit Breakers, press the Scroll button. Press Main to return to the previous menu.

Outlet Information Submenu

The Outlet submenu is to display Current, Voltage, and Power from Outlet number 1 to number N.

Power>Outlet Information

On the Power menu, scroll down to highlight Outlet Information. Press Select to display the values for the first outlet. To navigate through Outlet number 1 to number n, press the Select button. Press Main to return to the previous menu.

NOTE: Custom outlet names noted in the Web UI do not make changes to the local display. This is done to make it easier to map to outlet numbers which can be seen locally on the outlets themselves.

Sensors Menu

The Sensor menu displays the information related to the respective Environmental and Security sensor. The display shows temperature, humidity, leaks, etc.

On the Main Menu, scroll down to highlight **Sensor** and press Select. This will display the sensor data for the first sensor. Press Main to return to the previous menu.

NOTE: A maximum of eight (8) sensors can be configured per Rack PDU.

Web User Interface (Web UI)

Supported Web Browsers

The supported Web browsers are Google Chrome (mobile and desktop), Mozilla, Firefox, and Microsoft Edge on mobile and desktop.

NOTE: If the browser displays a “can’t reach this page” message, check that you are using the **https://** access protocol and not **http://**.

Log On to the Web User Interface

Confirm that the network connection has been established with the Rack PDU and that you have obtained the IP address.

Enter the IP address of the Rack PDU into your Web browser. The Login Page of the Web UI will open.

Log on to the Web UI. The default login is **admin** and the password is **12345678**.

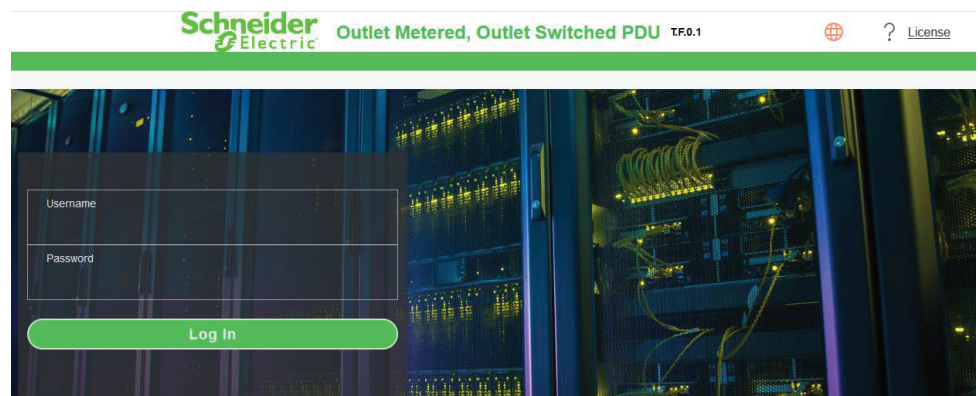

First Log On

When you log on to the Web UI for the first time, following the initial login page, you will be prompted to change the default account password. Type the current password, enter the new password and confirm the new password by entering it again in the appropriate space on the page. Click on the **Change Password** button at the bottom of the page to complete the process.

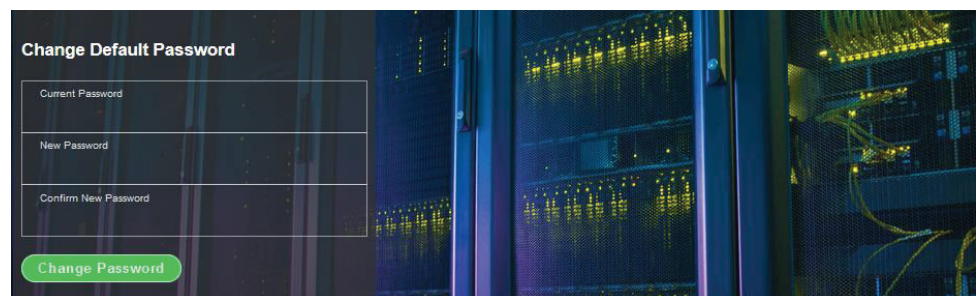

The password change is confirmed when the following window opens:

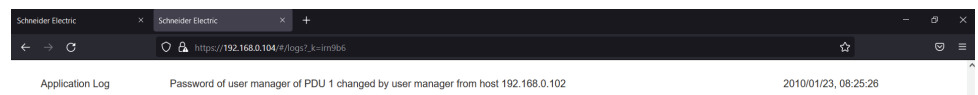



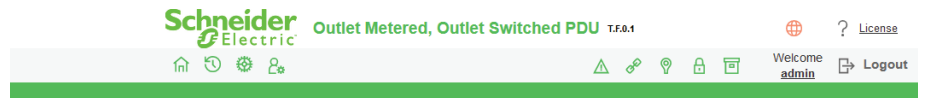

Changing your Password

If you need to change your password at any time following the initial password change requirement, follow the steps below:

1. Click on the User Settings icon  located at the top of the Web UI pages.



The User Settings page will open.

Users		
Username	Role	Action
admin	admin	
user	user	 
manager	manager	 

2. In the Users section, click the Edit icon  next to your Username and Role to open the Edit dialog box where you can change your password.
3. Type your new password in the **Password** field then, type it in again in the **Confirm Password** field. Click the **Save** button to save your changes.

Edit

User

Username
user

Password

Confirm Password

Role

Administrator

User

Manager

Save

SSL Certificate

To edit the **SSL Certificate Key Length**, click on the **Set Certificate Key** in the top right corner of the Network Settings page. The **Edit** window for SSL Certificate Key Length will open.

- Click on SSL Certificate Key Length
- Select **bits (1024/2048)** from the dropdown menu.

Edit

SSL Certificate Key Length

SSL Certificate Key Length
 2048 bits

Save

- Click on the **Save** button at the bottom of the Edit window to save your changes.





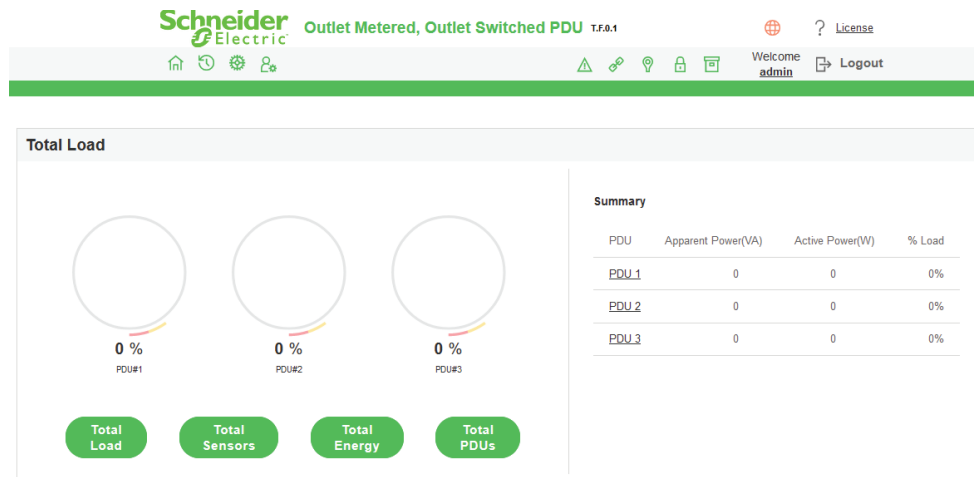

Navigating the Web UI

The Landing page (following login):



Note the icons across the top of the Landing page. The following table describes each icon.

Icon	Description
	Home icon: Select the Home icon to open the Home menu which includes: Dashboard, Identification, and Control & Manage.
	Logs icon: Select the Logs icon to view and download the logs and data logs of the PDU.
	Settings icon: The Settings icon allows the user to setup the Network Settings, System Management, SNMP Manager, Email Setup, Event Notifications, Trap Receiver, and Thresholds.
	User Settings icon: Select the User Settings icon to view the logged-in user, administrator, or manager. The user can also change account passwords and manage user accounts through this page. Users and Roles can be added (by admin or manager).

	<p>Alarm icon: Select the Alarm icon to view the details of the active critical alarms and active warning alarms. Alarms are configured based on different Thresholds which are set by the user on different parameters like Power, Voltage, Input Phase, Circuit Breaker and External Sensors. Icon colors can be changed based on Rack PDU alarm status. Critical Alarms always have high precedence over warnings.</p> <ul style="list-style-type: none"> • Red — Critical Alarms • Yellow — Warnings
	<p>Link icon: Select the Link icon to view the cascade connection status alarms.</p>
	<p>Sensor icon: Select this icon to view sensor related alarms.</p> <ul style="list-style-type: none"> • High Temperature • High Humidity • Dry
	<p>Security icon: Select this icon to view the Door sensor alarm status.</p>
	<p>Outlet status icon: Select this icon to view Circuit Breaker and Outlet alarm status.</p>
	<p>Language icon: Select this icon to choose a language. Choose from: English, French, Italian, Korean, German, Spanish, Japanese, and Chinese.</p>
	<p>Information icon: Select the Information icon to find information about the Rack PDU. Go to www.apc.com to get more information.</p>

The Home Menu

Click the Home icon  to see the dropdown menu.

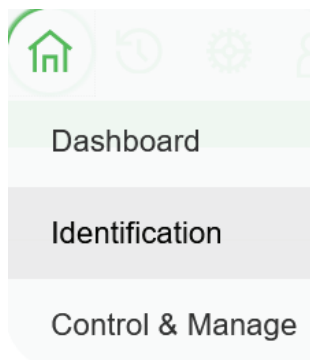

The options are:

- Dashboard: View total load details
- Identification: System information of the Rack PDUs in the network
- Control & Manage: View and edit the Outlets of your Rack PDUs by Circuit Breaker or Bank

Identification

Select the **Identification** page, to view the **System Information** and individual **PDU Information**.

The screenshot shows the 'Identification' page in a web browser. The page title is 'Schneider Electric Outlet Metered, Outlet Switched PDU 2.8.1'. The 'System Information' section is a table with the following data:

Name	Value	Name	Value
System Name		MAC Address	C8-45-44-69-26-35
Contact Name		IPv4 Address	10.10.106.16
Contact Email		IPv6 Link Local Address	fe80::ca45-44f8-f666-2b35
Contact Phone		IPv6 Auto Configured Address	2001:ca45:aa01:0:ca45:44f8:f666:2b35
Contact Location			

The 'PDU Information' section shows details for 'PDU# 1-1':

- Name: 1
- Core Location:
- Core U Position:
- Model: 348-415V, 16A, 11.5kVA, 50/60Hz
- Part Number: APDU102953M
- Serial Number: APC1
- Boot Version: 1.2
- Web Version: 2.0.0.D
- Firmware Version: 2.0.1
- Hardware Version: 1.00
- PDU Power Rating (kW): 11.5
- PDU Input Rating (A): 16
- PDU Breaker Rating (A): 0

The Dashboard Pages

Select Dashboard from the Home menu. The Dashboard page allows the user to view details relating to the Total Load, Total Sensors, Total Energy, and Total Rack PDUs.

The screenshot shows the 'Dashboard' page. The 'Total Load' section features three circular gauges for PDU#1, PDU#2, and PDU#3, all showing 0% load. Below the gauges are four buttons: 'Total Load', 'Total Sensors', 'Total Energy', and 'Total PDUs'. The 'Summary' table is as follows:

PDU	Apparent Power(VA)	Active Power(W)	% Load
PDU_1	0	0	0%
PDU_2	0	0	0%
PDU_3	0	0	0%

Select the Total Energy button on the opening page of the Dashboard to open the Energy Information page.

The screenshot shows the 'Energy Information' page. The 'Total Energy' section displays '1.412 kWh Total' with a progress bar. Below the bar is a legend: PDU 1: 0.703 kWh, PDU 2: 0.709 kWh, Total: 1.412 kWh. There are four buttons: 'Total Load', 'Total Sensors', 'Total Energy', and 'Total PDU(s)'. The 'Summary' table is as follows:

PDU Name	Total Energy(kWh)	Energy(kWh) [Since]
PDU 1	0.703	0.703 [2021/11/23 15:29:17]
PDU 2	0.709	0.709 [2021/11/23 15:29:36]

NOTE
The page shows energy accumulation at each PDU level as well as sum of all PDU energy. Legend information summarize energy information by PDU. Mousehover on Legend or Bar will display energy value in kWh. Color code may repeat over again if system is connected with more than 6 PDU. Color is just used here for graphics not meant for anything else..

View the total number of Rack PDUs connected in your network.

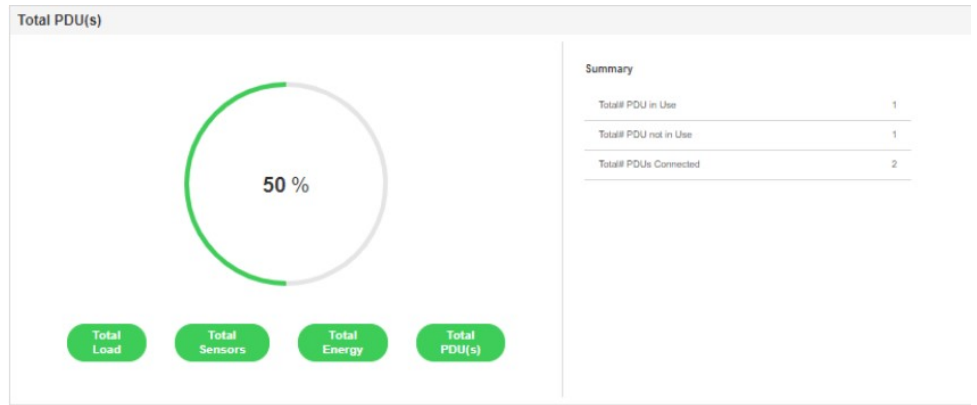

View external sensors, sensor readings, and the Rack PDU (by its number) hosting the sensors.

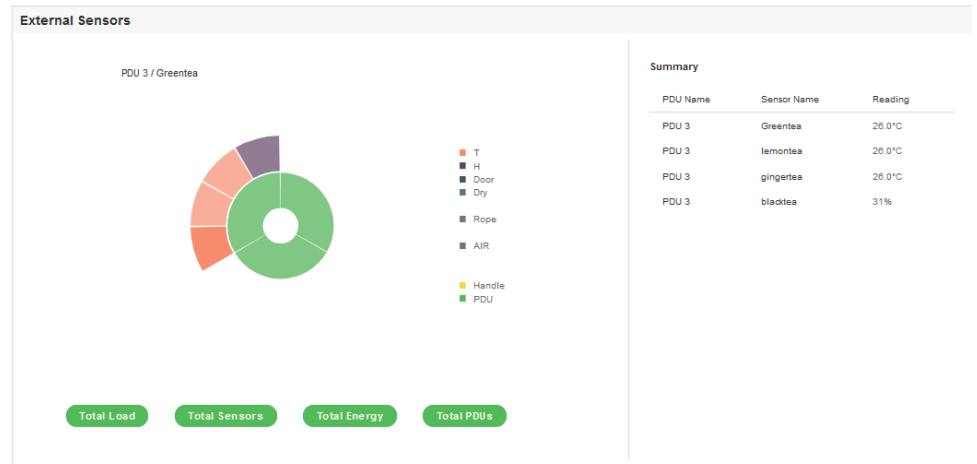

Control and Manage

Click the Home icon  and select **Control and Manage** from the dropdown menu.

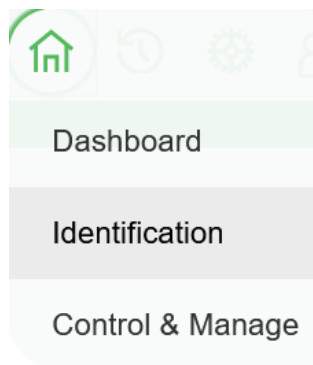

You can view and control the **Power Outlets** of the Rack PDU.

Click the **Outlet Control Enabled** button.

The page can be viewed in two separate modes by selecting either **CB** (to view the circuit breaker information) or **Bank #** mode (to view banks of outlets) to enable.

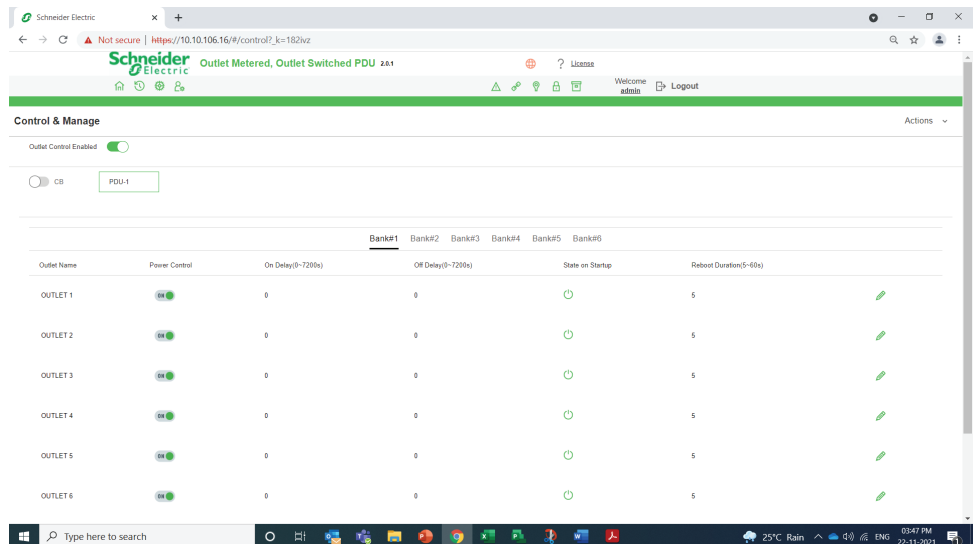

Click the Edit icon  to change the Outlet information.

Outlet name: Identify the outlet

On delay time: 0 — 7200 seconds

Off delay time: 0 — 7200 seconds

State on startup: Choices are **On**, **Off**, and **Last Known**

Reboot duration: Configure the time for the reboot duration between 5 to 60 seconds

Edit

Outlet Information

Outlet Name	OUTLET 1
On Delay(0~7200s)	0
Off Delay(0~7200s)	0
State on Startup	On
Reboot Duration(5~60s)	5

Save

View Logs

From this page, the user can view, download, or clear logs generated by the activities of the Rack PDU. Click on the Log icon  to see the dropdown menu. The available options are:

- View Logs
- Download Logs
- View Datalogs
- Download Data Log

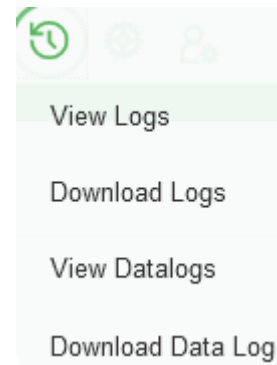

Select **View Logs** to view the information. Some of the actions performed by the Rack PDU are:

- Generating Event, Audit, and Application logs
- Recording Power Share details

View Logs		
Type	Description	Date & Time
Audit Log	User admin of PDU 1 from host 10.10.107.75 logged in	2010/01/17, 01:53:33
Event Log	Frequency on Input Phase 3 of PDU 2 asserted below lower critical	2010/01/16, 14:02:38
Event Log	Frequency on Input Phase 2 of PDU 2 asserted below lower critical	2010/01/16, 14:02:38
Event Log	Frequency on Input Phase 1 of PDU 2 asserted below lower critical	2010/01/16, 14:02:38
Event Log	Frequency on Input Phase 3 of PDU 2 deasserted below lower critical	2010/01/16, 14:01:47
Event Log	Frequency on Input Phase 2 of PDU 2 deasserted below lower critical	2010/01/16, 14:01:47
Event Log	Frequency on Input Phase 1 of PDU 2 deasserted below lower critical	2010/01/16, 14:01:46

Click on the **Download** or **Clear** buttons in the top right corner of the **View Logs** page.



View Data Logs

View, configure, download, and clear the Data recorded by the Rack PDU.

- **Energy** information
- **Power** information
- **Date and Time** information

Click on the **Log** icon  to view the dropdown menu.

Select **View Data Logs** to open the **Data Log** page.

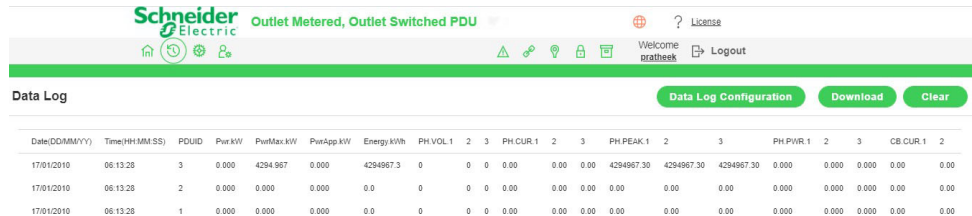

Date(DDMMYY)	Time(HH:MM:SS)	PDUID	Pwr kW	PwrMax kW	PwrApp kW	Energy kWh	PH.VOL 1	2	3	PH.CUR 1	2	3	PH.PEAK 1	2	3	PH.PWR 1	2	3	CB CUR 1	2
17/01/2010	06:13:28	3	0.000	4294.967	0.000	4294967.3	0	0	0	0.00	0.00	0.00	4294967.30	4294967.30	4294967.30	0.000	0.000	0.000	0.00	0.00
17/01/2010	06:13:28	2	0.000	0.000	0.000	0.0	0	0	0	0.00	0.00	0.00	0.00	0.00	0.00	0.000	0.000	0.000	0.00	0.00
17/01/2010	06:13:28	1	0.000	0.000	0.000	0.0	0	0	0	0.00	0.00	0.00	0.00	0.00	0.00	0.000	0.000	0.000	0.00	0.00

At the top right corner of the **Data Log** page, you can select from three buttons, **Data Log Configuration**, **Download**, to download the data logs, and **Clear** to delete the data logs.

To enable log configuration and set the log interval time (in minutes), select the **Data Log Configuration** button to open the **Edit** dialog box.

Edit

Data Log Configuration

Enable

Log Interval(1-1440 Minutes)
10

Save

Settings

Manage the IP Configuration, Web RESTapi Access Configuration, SSH/FTP's Configuration, Network Time Protocol (NTP), Date/Time Settings and Daylight Savings Time.

The Rack PDU supports IPv4 and IPv6 Internet Protocol options with full network management and alerting capabilities. After you select your Internet protocol option, you will be able to communicate using HTTP, HTTPS, SNMP, FTPS and Email for network communications.

Click on the Settings icon  to open the dropdown menu. The menu options are:

- Network Settings
- System Management
- SNMP Manager
- Email Setup
- Event Notifications
- Trap Receiver
- Thresholds

Network Settings

The Network Settings page allows the management of IP Configuration, Web RESTapi Access Configuration, SSH/FTPS Configuration, Network Time Protocol (NTP), Date/Time Settings and Daylight-Savings Time Settings.

NetShelter Rack PDU Advanced supports IPv4 and IPv6 with full-featured network management and alerting capabilities. After you select your Internet protocol option, you will be able to communicate using HTTP, HTTPS, SNMP, FTPS, and email for network communications.

From the dropdown menu of the Settings icon , select Network Settings to open the Network Settings page.

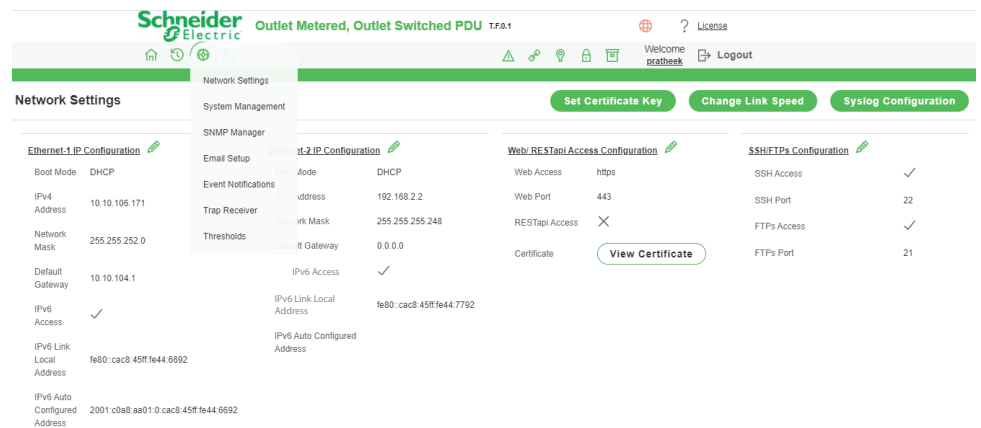

Click on the Edit icon  to open the **Edit IP Configuration** dialog box where you can change the information.

Select **DHCP** to auto-configure the IP Address of the Rack PDU.
Select **Static** to manually configure the IP Address and then fill in the remaining fields of the dialog box.

If you are manually configuring the IP Address, enter the following:

IPv4 address

Network Mask

Default Gateway

Once you have configured the settings, click the **Save** button to save your changes.

Edit

IP Configuration

Boot Mode	<input checked="" type="radio"/> DHCP <input type="radio"/> Static
IPv4 Address	10.10.106.171
Network Mask	255.255.252.0
Default Gateway	10.10.104.1
IPv6 Access	<input checked="" type="checkbox"/>

Save

RESTapi Access Configuration

The Rack PDU is accessed using HTTPS by default.

Click the Edit icon  to open the **Edit Web/RESTapi Access Configuration** dialog box where you can enter your information.
The available settings are:

Web Access (HTTP or HTTPS)

Web Port (Default 80 for HTTP, and 443 for HTTPS)

Enable **RESTapi Access**

To access the HTTPS settings, upload the **SSL Certificate** and **SSL Certificate Key** provided by Schneider Electric.

Click the **Save** button to confirm and save your settings.

Edit

Web/ RESTapi Access Configuration

Web Access
Https
Web Port
Default 80 for Http, 443 for Https
443
RESTapi Access
Disable
SSL Certificate
SSL Certificate
<input type="button" value="Choose File"/> No file chosen
SSL Certificate Key
<input type="button" value="Choose File"/> No file chosen

Setting the Time and Date

The date and time can be set either by connecting to a Network Time Protocol (NTP) server or by setting the time manually.

Network Time Protocol (NTP)

Link the Rack PDU to a **Network Time Protocol (NTP)** server and let it set the date and time.

Click the Edit icon  to open the **Edit NTP** dialog box.

Click on the **Enable** button to enable NTP settings.

To synchronize the Rack PDU time with a selected server:

Type the valid **Primary** NTP server address

Type the valid **Secondary** NTP server address

Select the desired **NTP GMT offset** time from the dropdown list.

Click the **Test** button to confirm that the network is valid.

Click the **Save** button to confirm and save your changes.

Edit

Network Time Protocol(NTP)

Enable
<input type="checkbox"/>
Primary NTP Server
0.0.0.0
Secondary NTP Server
0.0.0.0
NTP GMT Offset
(UTC) Dublin, Edinburgh, Lisbon, London
<input type="button" value="Test"/>
<input type="button" value="Save"/>

Manually Setting the Date and Time

You can manually set the internal clock on the Rack PDU by clicking on the Edit icon  to open the **Edit Date/Time Settings** dialog box.

Type the **Date** in YYYY-MM-DD format or use the calendar icon.

Type the **Time** in HH:MM:SS format and time is measured in 24-hour format.

Click the **Save** button in the bottom of the Edit window to save your changes.

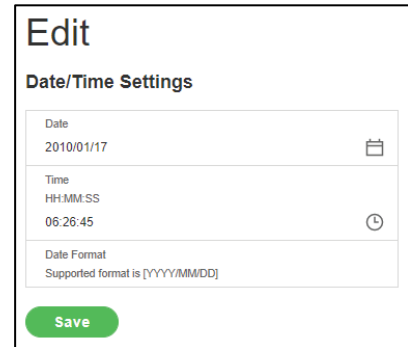

Daylight Saving Time

Click the Edit icon  to open the **Edit Daylight Saving Time** dialog box.

Click on the **Enable** button to enable Daylight Saving Time.

Select the specifics of the **Start Month**. The choices are:

- Month
- Week
- Day
- Time

Select the specifics of the **End Month**. The choices are:

- Month
- Week
- Day
- Time

Assign the **Time Offset**.

Click the **Save** button to save your settings.

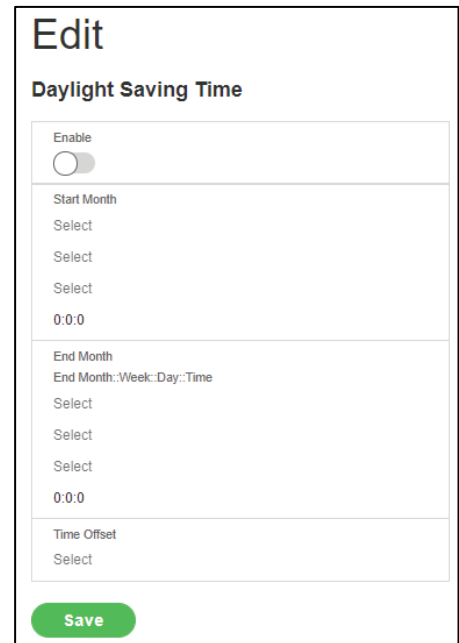

Ethernet Link Speed

Click on the **Change Link Speed** button in the top right corner of the **Network Settings** page to open the **Ethernet Link Speed** Edit dialog box.

Click on Link Speed to open the dropdown menu.

Select from the following options:

- Auto Negotiation
- 10/100 Mbps
- 1 Gbps

Click on the **Save** button to save your settings.

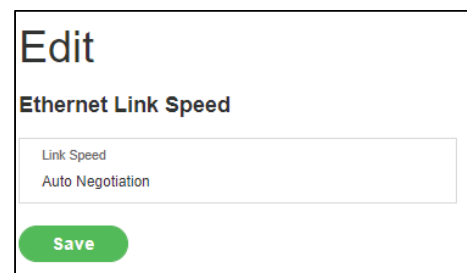

Syslog Configuration

Click on the **Syslog Configuration** button in the top right corner of the Network Settings window to open the **Edit System Log Configuration** window to **Enable Syslog Server Access**.

Click on the **Enable Syslog Server Access** button

Enter the **Syslog Server Address**

Select the **Syslog Server Port** number

Click the **Save** button to save your settings.

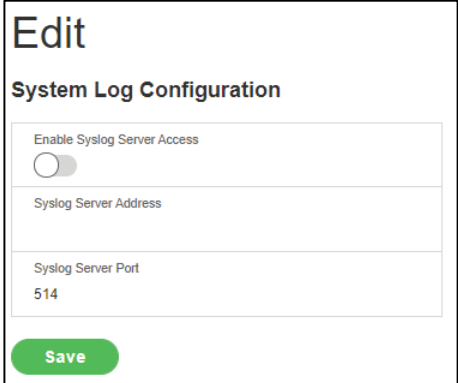

Edit

System Log Configuration

Enable Syslog Server Access

Syslog Server Address

Syslog Server Port
514

Save

System Management

Click on the Settings icon  to open the dropdown menu. Select **System Management** from the menu to open the System Management page.

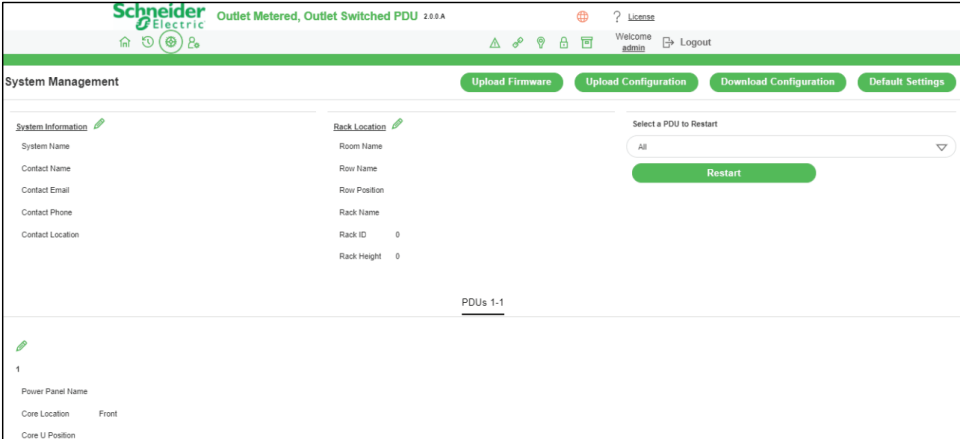

Schneider Electric Outlet Metered, Outlet Switched PDU 2.0.0.A

System Management **Upload Firmware** **Upload Configuration** **Download Configuration** **Default Settings**

System Information

System Name

Contact Name

Contact Email

Contact Phone

Contact Location

Rack Location

Room Name

Row Name

Row Position

Rack Name

Rack ID 0

Rack Height 0

Select a PDU to Restart

All

Restart

PDUs 1-1

Power Panel Name	Core Location	Core U Position
1	Front	

You can perform functions like **Uploading Firmware**, **Uploading Configuration**, **Downloading Configuration** and returning the settings of the Rack PDU to the **Default Settings** from the System Management page. You can also **Restart** the Rack PDU from the System Management page.

Edit System Information

Click on the Edit icon  to open the **Edit System Management** dialog box and make changes to the System Information. You can enter the following information:

The **System Name** of the Rack PDU for identification.

The **Contact Name** of the contact person.

The **Contact Email** address of the contact person.

The **Contact Location** of the contact person.

Click the **Save** button in the bottom of the window to save your settings.

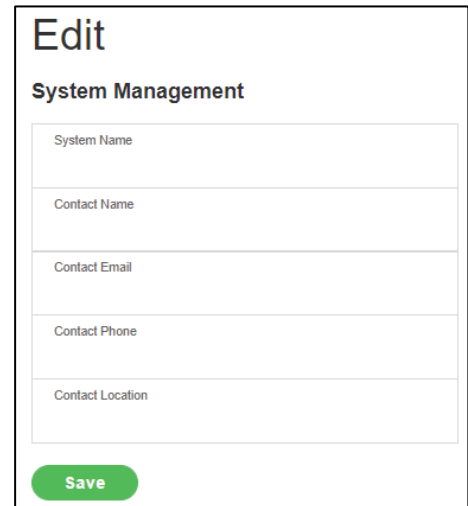

The screenshot shows a dialog box titled "Edit" with a subtitle "System Management". It contains five text input fields: "System Name", "Contact Name", "Contact Email", "Contact Phone", and "Contact Location". A green "Save" button is located at the bottom right of the dialog box.

Edit Rack Location

Click on the Edit icon  to open the **Edit Rack Location** dialog box. You can enter the following information:

Room Name: the room where the Rack PDU is located.

Row Name: the row where the Rack PDU is located.

Rack Name: the rack where the Rack PDU is located.

Rack ID: the identification of the rack.

Rack Height: the height of the Rack where the Rack PDU is located.

Click on the **Save** button to save your changes.

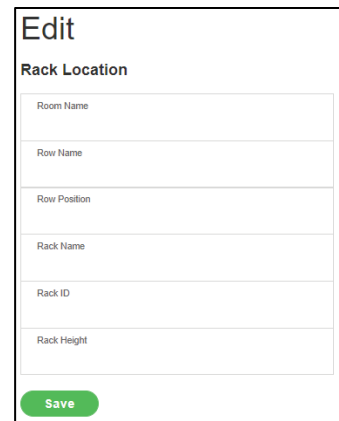

The screenshot shows a dialog box titled "Edit" with a subtitle "Rack Location". It contains five text input fields: "Room Name", "Row Name", "Row Position", "Rack Name", and "Rack ID". A green "Save" button is located at the bottom right of the dialog box.

Edit Power Panel and Core Location

Click on the Edit icon  to open the **Edit Power Panel & Core Location** dialog box. You can enter the following information:

Power Panel Name: Name with which you will identify the Rack PDU.

Core Location: location (**Front** or **Back**) of the rack in which the Rack PDU is located.

Core U Position: the U-space location of the Rack PDU within the rack.

Click the **Save** button to save your settings.

Edit

Power Panel & Core Location

Power Panel Name
Core Location Front
Core U Position

Save

SNMP Management

Simple Network Management Protocol (SNMP) is used to manage the Rack PDU (s) remotely. SNMP allows you to monitor and detect network faults and to configure variable data in the Rack PDU.

Click on the Settings icon  to open the dropdown menu. Select **SNMP Management** from the menu to open the SNMP Management page. From the **SNMP Management** page, you can manage the transfer of data from the Rack PDU to the MIB Browser.

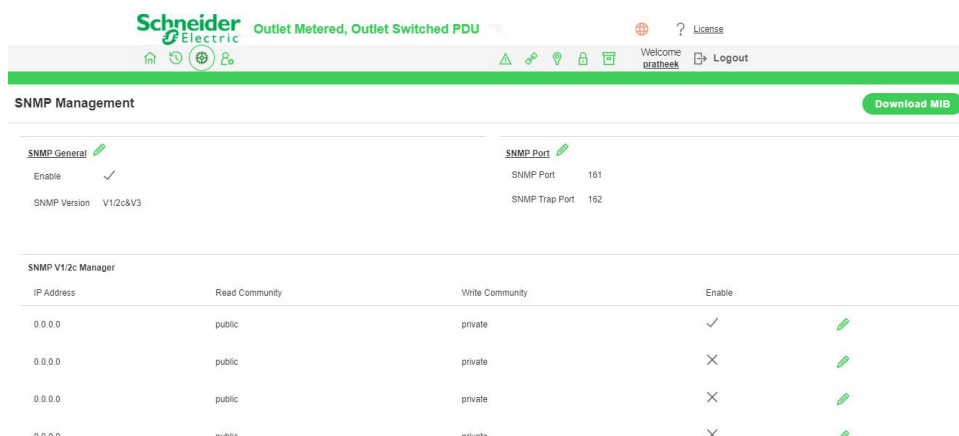

IP Address	Read Community	Write Community	Enable
0.0.0.0	public	private	<input checked="" type="checkbox"/>
0.0.0.0	public	private	<input type="checkbox"/>
0.0.0.0	public	private	<input type="checkbox"/>
0.0.0.0	public	private	<input type="checkbox"/>

SNMP General

To access the Rack PDU data inside an MIB Browser:

Click on the Edit icon  next to **SNMP General** on the **SNMP Management** page.

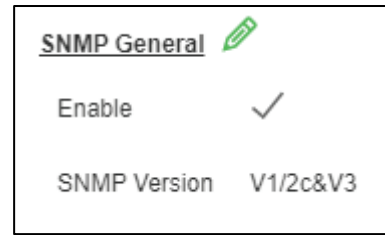

The dialog box titled "SNMP General" has a pencil icon in the top right corner. It contains two rows of settings: "Enable" with a checkmark icon, and "SNMP Version" with the value "V1/2c&V3".

In the **SNMP General** dialog box, click on the **Enable** button.

Click on the **Save** button to save the changes.

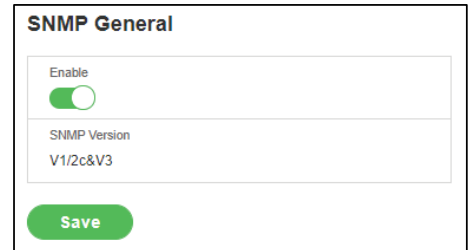

The dialog box titled "SNMP General" has a pencil icon in the top right corner. It contains a toggle switch for "Enable" which is turned on, and "SNMP Version" with the value "V1/2c&V3". A green "Save" button is at the bottom.

SNMP Port

To secure the link between the Rack PDU and the MIB Browser:

Click the Edit icon  next to **SNMP Port** on the **SNMP Management** page.

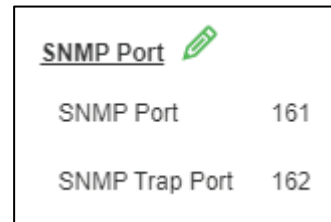

The dialog box titled "SNMP Port" has a pencil icon in the top right corner. It contains two rows of settings: "SNMP Port" with the value "161", and "SNMP Trap Port" with the value "162".

In the dialog box:



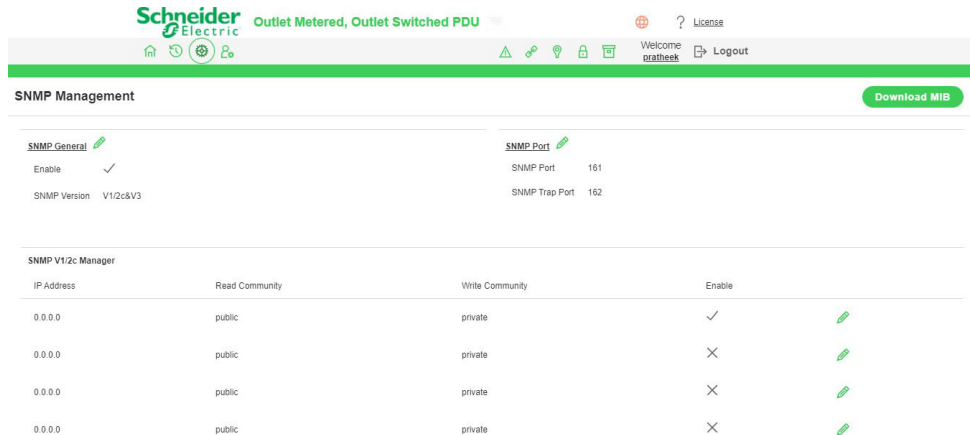

- Enter the **SNMP Port** number.
- Enter the **SNMP Trap Port** number.
- Click the **Save** button to save your settings.

Configure Users for SNMP V1/V2c

On the **SNMP Management** page, click the Edit icon  next to the chosen address in the **SNMP V1/2c Manager** section of the page.



The screenshot displays the Schneider Electric web interface for SNMP Management. At the top, the Schneider Electric logo and 'Outlet Metered, Outlet Switched PDU' are visible. The page title is 'SNMP Management' with a 'Download MIB' button. The 'SNMP General' section shows 'Enable' checked and 'SNMP Version' set to 'V1/2c&V3'. The 'SNMP Port' section shows 'SNMP Port' as 161 and 'SNMP Trap Port' as 162. The 'SNMP V1/2c Manager' table has the following data:

IP Address	Read Community	Write Community	Enable	
0.0.0.0	public	private	✓	
0.0.0.0	public	private	✗	
0.0.0.0	public	private	✗	
0.0.0.0	public	private	✗	

When the **Edit SNMP V1/V2c Manager** dialog box opens, you can enter the following information:

The IP Address

Define the security to **public** or **private** in:

Read Community

Write Community

Click on the **Enable** button to enable SNMP V1/V2c.

Click the **Save** button to save your changes.

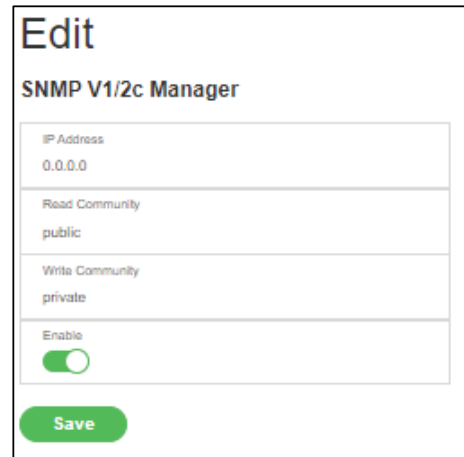





The 'Edit' dialog box for 'SNMP V1/2c Manager' contains the following fields and controls:

- IP Address: 0.0.0.0
- Read Community: public
- Write Community: private
- Enable:
- Save button

Configure Users for SNMP V3

Configure users for SNMP V3 to ensure higher security of data transfer to the MIB browser. Click the Edit icon  to change the settings of the **SNMP V3 Manager**.

Username	Security Level	Authentication Password	Authentication Algorithm	Privacy Key	Privacy Algorithm	Enable	
	NoAuthNoPriv	*****	MD5	*****	AES128	X	
	NoAuthNoPriv	*****	MD5	*****	AES128	X	
	NoAuthNoPriv	*****	MD5	*****	AES128	X	
	NoAuthNoPriv	*****	MD5	*****	AES128	X	
	NoAuthNoPriv	*****	MD5	*****	AES128	X	

Enter the **Username**.

Click the **Security Level** and assign the level from the dropdown menu:

NoAuthNoPriv: No authentication and no privacy. (The default.)

AuthNoPriv: Authentication and no privacy.

AuthPriv: Authentication and privacy.

Type a new, unique password as the **Authentication Password**.

Select the **Authentication Algorithm**. The options are:

MD5

SHA

Enter a new, unique password as the **Privacy Key**.

Select the **Privacy Algorithm**. The choices are:

DES

AES-128

AES-192

AES-256

Click the **Enable** button to enable SNMP V3.

Click the **Save** button to save your settings.

Edit

SNMP V3 Manager

Username
Security Level No Auth No Priv
Authentication Password
Authentication Algorithm MD5
Privacy Key
Privacy Algorithm AES128
Enable <input type="checkbox"/>

Save

Setup Email

To enable your Rack PDU to send alerts or event messages using email, you must configure the information about the Simple Mail Transfer Protocol (SMTP).

1. Click the **Settings** icon  to open the dropdown menu.
2. Select **Email Setup** from the menu to open the **Email Setup** page.

Email Setup Send Test Email

SMTP Account Settings 

Email Server Address

Sender Address

Username

Password *****

Port

Number of Sending Retries

Time Interval Between Sending Retries(In Minutes)

Server Requires Authentication

3. To set SMTP server settings to receive emails and notifications, click the Edit icon  to open the **SMTP Account Settings** dialog box where you can configure the settings.

Enter the **Email Server Address**, the IP address of the SMTP for accepting messages.

Enter the email address from which the recipient will receive mail in the **Sender Address** field.

Configure the **Port** number, which is the communication endpoint on the server. The default is **25**.

Enter the **Username** for SMTP security.

Enter the **Password** for SMTP security.

Assign the **Number of Sending Retries**, which is the number of times the Rack PDU will attempt to resend a message if the message fails. The default is **3**.

Enter the **Time Interval Between Sending Retries** (in minutes). The default is **6** minutes.

Click to Enable **Server Requires Authentication** to password protect the SMTP.

Click the **Save** button to save your settings.

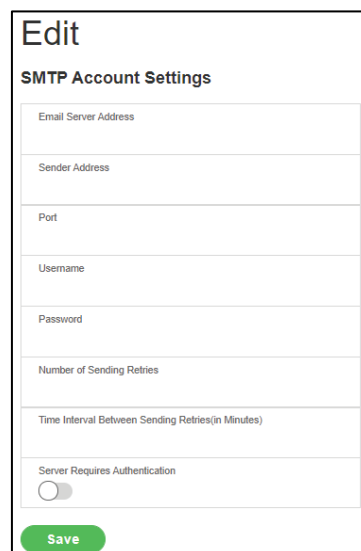

Send a Test Email

Click the **Send Test Email** button  in the top right corner of the Email Setup page to open the Test Email Recipients window.

Enter the **Recipient Email Address**.

Click the **Send** button to send the email.

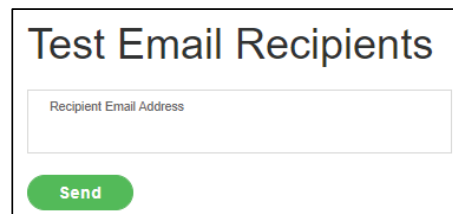

Event Notifications

Assign **Event Notifications** from the Rack PDU to the Syslog, SNMP Trap and email. An event notification has two parts:

- **Event:** the situation where the Rack PDU experiences a monitored condition (temperature sensor exceeds a warning limit or circuit breaker status change).
- **Action:** the assigned response to the event (send an SMTP message and SNMP trap).

Click on the **Settings** icon  to open the dropdown menu.

Select **Event Notifications** from the menu to open the Event Notification page.

Click on the **Email**, **SNMP Trap** and **Syslog** buttons to enable the respective Events to receive notifications.

Events	Email	SNMP Trap	Syslog
Circuit Breaker Status Changed	<input type="checkbox"/>	<input type="checkbox"/>	<input type="checkbox"/>
User Activity	<input checked="" type="checkbox"/>	<input type="checkbox"/>	<input type="checkbox"/>
Smart Rack Access	<input checked="" type="checkbox"/>	<input type="checkbox"/>	<input checked="" type="checkbox"/>
Outlet Power Control Status Changed	<input type="checkbox"/>	<input type="checkbox"/>	<input type="checkbox"/>
User Status Changed	<input type="checkbox"/>	<input type="checkbox"/>	<input type="checkbox"/>
Critical Alarm	<input type="checkbox"/>	<input checked="" type="checkbox"/>	<input type="checkbox"/>
Warning Alarm	<input type="checkbox"/>	<input checked="" type="checkbox"/>	<input type="checkbox"/>
Password/Settings Changed	<input type="checkbox"/>	<input type="checkbox"/>	<input type="checkbox"/>
Network Card Reset/Start	<input type="checkbox"/>	<input checked="" type="checkbox"/>	<input type="checkbox"/>
External Sensor Status Changed	<input type="checkbox"/>	<input type="checkbox"/>	<input type="checkbox"/>
PDU Configuration File Imported/Exported	<input type="checkbox"/>	<input type="checkbox"/>	<input checked="" type="checkbox"/>
User Role Status Changed	<input type="checkbox"/>	<input type="checkbox"/>	<input type="checkbox"/>
Firmware Update	<input type="checkbox"/>	<input type="checkbox"/>	<input type="checkbox"/>
Communication Status Changed	<input type="checkbox"/>	<input type="checkbox"/>	<input type="checkbox"/>
Daisy Chain Status Changed	<input type="checkbox"/>	<input type="checkbox"/>	<input type="checkbox"/>
Enter Bootloader Mode	<input type="checkbox"/>	<input type="checkbox"/>	<input type="checkbox"/>
LDAP/RADIUS Error	<input type="checkbox"/>	<input type="checkbox"/>	<input type="checkbox"/>
Power Sharing Status Changed	<input type="checkbox"/>	<input type="checkbox"/>	<input type="checkbox"/>

NOTE: Critical and Warning alarms are enabled at the SNMP Trap by default. These notifications for the default events can only be received after the **Trap Receiver** (in the following section) is configured.





Configure the Trap Receiver

Click on the **Settings** icon  to open the dropdown menu.

Select **Trap Receiver** from the menu to open the Trap Receiver page.

SNMP V1 Trap Receiver

Configuring users for SNMP V1 Trap Settings allows communication to the MIB browser.

Trap Receiver				Send Test Trap
SNMPV1 Trap Receiver				
Name	Host	Community	Enable	
		public	<input type="checkbox"/>	
		public	<input type="checkbox"/>	
		public	<input type="checkbox"/>	
		public	<input type="checkbox"/>	
		public	<input type="checkbox"/>	

Click on the Edit icon  to open the **Edit SNMPV1 Trap Receiver** dialog box. Enter the following information:

Enter the **Name** to identify the different receivers.

Enter the **Host** IP address to which the traps are sent.

Select from **public** or **private** security status options to assign to the **Community**.

Click on the **Enable** button.

Click the **Save** button to save your settings.

Edit

SNMPV1 Trap Receiver

Name

Host

Community
public

Enable

Save

SNMP V3 Trap Receiver

Configuring users for SNMP V3 Trap Settings allows encrypted communication to the MIB browser.

Click on the Edit icon  to open the **Edit SNMPV3 Trap Receiver** dialog box.

Enter the **Name** to identify the different receivers.

Enter the **Host** IP address to which the traps are sent.

Click on **Security Level** to open the dropdown menu. Select from the following choices:

NoAuthNoPriv: No authentication and no privacy (the default)

AuthNoPri: Authentication and no privacy

AuthPriv: Authentication and privacy

Enter a new, unique password as the **Authentication Password**.

Select the **Authentication Algorithm** from the following choices:

MD5

SHA

Type a new, unique password as the **Privacy Key**.

Select the **Privacy Algorithm** from the following choices:

DES

AES-128

AES-192

AES-256

Click on the **Enable** button to enable SNMP V3.

Click the **Save** button to save your settings.

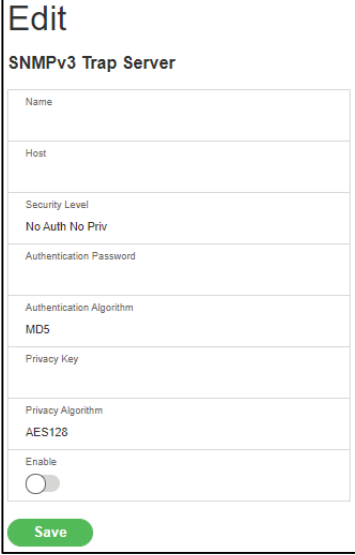

Send Test Trap

Click on the **Send Test Trap** button located in the top right corner of the **Trap Receiver** page to send a test Trap to check that the feature is active.

Defining Rack PDU Thresholds

Thresholds are the limits you define over Rack PDU parameters (power, phase, circuit breaker and sensors) to send alert notifications when the value crosses above or below the set limit.

Click on the **Settings** icon  to open the dropdown menu.

Select **Thresholds** from the menu to open the PDU Thresholds page.

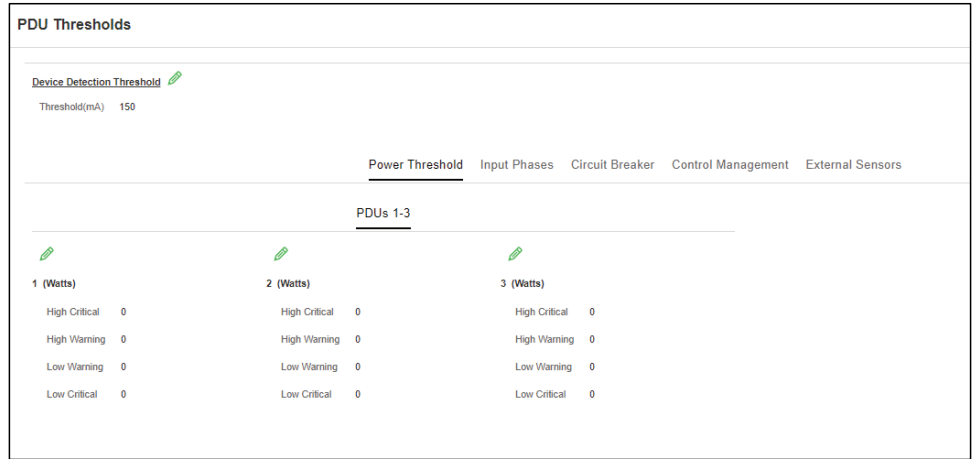

Power Thresholds

The Rack PDU will send alert notifications when a power threshold wattage crosses above or below the settings you specify in **Power Threshold**.

Follow the steps below to change the Power Thresholds settings and alarm notifications:

- Select the **Power Threshold** tab on the PDU Threshold page.
- Click the Edit icon  to change the Power Threshold Setting.
- In the **PDU Power Threshold Setting** dialog box, change the fields as needed:

Low Critical (W)

Low Warning (W)

High Warning (W)

High Critical (W)

Reset Threshold (W)

Alarm State Change Delay (samples)

Click the **Save** button to save your changes.

Edit

PDU Power Threshold (W)

High Critical	0
Enable High Critical	<input type="radio"/>
High Warning	0
Enable High Warning	<input type="radio"/>
Low Warning	0
Enable Low Warning	<input type="radio"/>
Low Critical	0
Enable Low Critical	<input type="radio"/>
Reset Threshold	0
Alarm State Change Delay (Samples)	0

Save

NOTE: Repeat the above steps for each Rack PDU in your network.

Input Phase Thresholds

The Rack PDU will send alert notifications when a phase current and voltage alarm crosses above or below the settings you specify in the **Input Phase Threshold** page.

Follow the steps below to change the Input Phase Settings and alarm notifications:

- Select the **Input Phases** tab on the PDU Threshold page.
- Click the Edit icon  to change the Phase Current Settings.

- You can change the fields listed below as needed in the **Input Phase Current Alarm Setting** dialog boxes:

Low Critical (A)

Low Warning (A)

High Warning (A)

High Critical (A)

Reset Threshold (A)

Alarm State Change Delay (samples)

Click the **Save** button to save your changes.

Edit

Input phases current alarm setting

Low Critical (A)	0
Enable Low Critical	<input type="radio"/>
Low Warning (A)	0
Enable Low Warning	<input type="radio"/>
High Warning (A)	22
Enable High Warning	<input checked="" type="checkbox"/>
High Critical (A)	28
Enable High Critical	<input checked="" type="checkbox"/>
Reset Threshold (A)	1
Alarm State Change Delay (Samples)	0

Save

NOTE: Repeat the above steps for each Rack PDU in your network.

Phase Voltage Settings

From this page, you can select the Phase settings you want to configure.

	Power Threshold	Input Phases	Circuit Breaker	Control Management	External Sensors	
1						
Phase Current	Reading(A)	Low Critical	Low Warning	High Warning	High Critical	
Phase1	0.0	0.0	0.0	41.0	48.0	
Phase2	0.0	0.0	0.0	41.0	48.0	
Phase3	0.0	0.0	0.0	41.0	48.0	
Phase Voltage	Reading(V)	Low Critical	Low Warning	High Warning	High Critical	
Phase1	198.7	180.0	190.0	215.0	225.0	
Phase2	198.6	180.0	190.0	215.0	225.0	
Phase3	198.6	180.0	190.0	215.0	225.0	

To edit or change the Phase Voltage Settings, click the Edit icon  to open the **Input Phase Voltage Alarm Setting** dialog boxes. The following settings can be accessed here:

- Low Critical (V)
 - Low Warning (V)
 - High Warning (V)
 - High Critical (V)
 - Reset Threshold (V)
 - Alarm State Change Delay (samples)
- Click the **Save** button to save your settings.

Edit

Input phases current alarm setting

Low Critical (A)	0
Enable Low Critical	<input type="radio"/>
Low Warning (A)	0
Enable Low Warning	<input type="radio"/>
High Warning (A)	22
Enable High Warning	<input checked="" type="checkbox"/>
High Critical (A)	28
Enable High Critical	<input checked="" type="checkbox"/>
Reset Threshold (A)	1
Alarm State Change Delay (Samples)	0

[Save](#)

NOTE: Repeat the above steps for each Rack PDU in your network.

Circuit Breaker Thresholds

Set **Circuit Breaker Thresholds** so the Rack PDU will send alert notifications when a circuit breaker amperage crosses above or below the settings you specify.

Below are the steps to change the Circuit Breaker Settings and alarm notifications:

- Choose the **Circuit Breaker** tab in the PDU Threshold page.

Power Threshold					Input Phases			Circuit Breaker				Control Management		External Sensors					
													1	2	3				
Bank	Low Critical	Low Warning	High Warning	High Critical															
1	0.0	0.0	11.0	14.0															
2	0.0	0.0	11.0	14.0															
3	0.0	0.0	11.0	14.0															
4	0.0	0.0	11.0	14.0															
5	0.0	0.0	11.0	14.0															
6	0.0	0.0	11.0	14.0															

- Click the Edit icon  for each bank to change the Circuit Breaker Settings. The following settings can be accessed here:

- Low Critical (A)
- Low Warning (A)
- High Warning (A)
- High Critical (A)
- Reset Threshold (A)
- Alarm State Change Delay (samples)

Click the **Save** button to save your settings.

Edit

Bank

Low Critical (A)
0

Enable Low Critical

Low Warning (A)
0

Enable Low Warning

High Warning (A)
11

Enable High Warning

High Critical (A)
14

Enable High Critical

Reset Threshold (A)
1

Alarm State Change Delay (Samples)
0

Save

NOTE: Repeat the above steps for each Rack PDU in your network.

Control Management

Select the **Control Management** tab to configure thresholds so the Rack PDU will send alert notifications when an outlet wattage crosses above or below the settings you specify in the Control Management Thresholds.

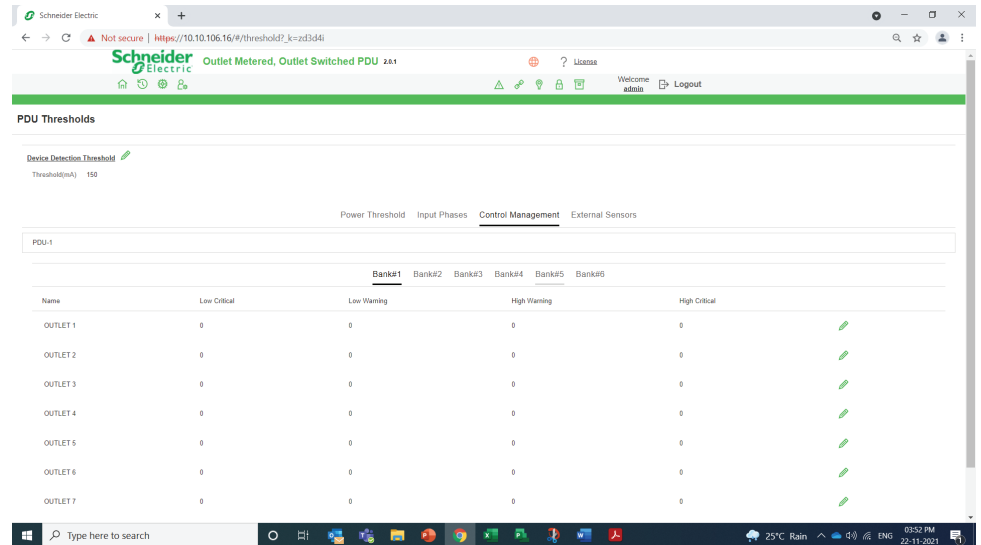

- Select the Rack PDU by name.
- Click the Edit icon  to open the **Edit Outlet Information** dialog box. The following settings can then be accessed:

Low Critical (W)

Low Warning (W)

High Warning (W)

High Critical (W)

Reset Threshold (W)

Alarm State Change Delay (samples)

Click the **Save** button to save your settings.

The 'Edit Outlet Information' dialog box shows the following settings:

- Low Critical (W): 0
- Set Lower Critical:
- Low Warning (W): 0
- Set Lower Warning:
- High Warning (W): 0
- Set High Warning:
- High Critical (W): 0
- Set High Critical:
- Reset Threshold (W): 0
- Alarm State Change Delay (Samples): 0

A green 'Save' button is located at the bottom of the dialog.

NOTE: Repeat the above steps for each Rack PDU in your network.

External Sensors

The **External Sensors** section displays the connected sensors on the Rack PDU. Choose the External Sensors tab on the **PDU Threshold** page to configure the sensor settings so the Rack PDU can communicate the sensor location, alarms, notifications, and details.

- Click the Edit icon  to open the **Edit External Sensors(3:1)** dialog box where you can edit the External Sensors Settings. The following settings can then be accessed:

Low Critical

Low Warning

High Warning

High Critical

Click the **Save** button to save your settings.

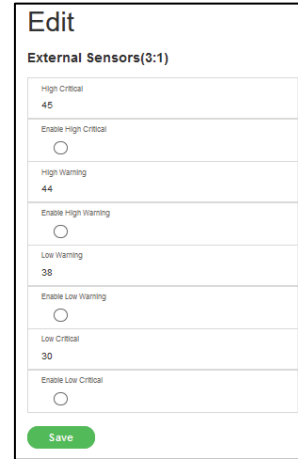

Edit
External Sensors(3:1)

High Critical	45	<input type="checkbox"/>
High Warning	44	<input type="checkbox"/>
Low Warning	38	<input type="checkbox"/>
Low Critical	30	<input type="checkbox"/>

Save

NOTE: Repeat the above steps for each Rack PDU in your network.

User Settings

The Rack PDU has a standard **Admin** profile and a standard **User** profile.

- The **Admin** profile is typically the system administrator and has the “Admin Role” with full operating permissions.
- The default **User** profile includes the default “User Role” permissions. All other user privileges must be added by the Admin user. Users are defined by their unique login credentials and by their user role.

Before setting up the user profile, determine the roles required. Each user must be given a **Role**. These Roles define the permissions which are granted to the user.

- Admin:** Complete system permissions
- User:** By default, the user can change their own password. Other permissions must be granted by Admin.
- Manager:** Complete system permissions. Primarily the Manager is intended to be the Redfish (RESTapi) user.

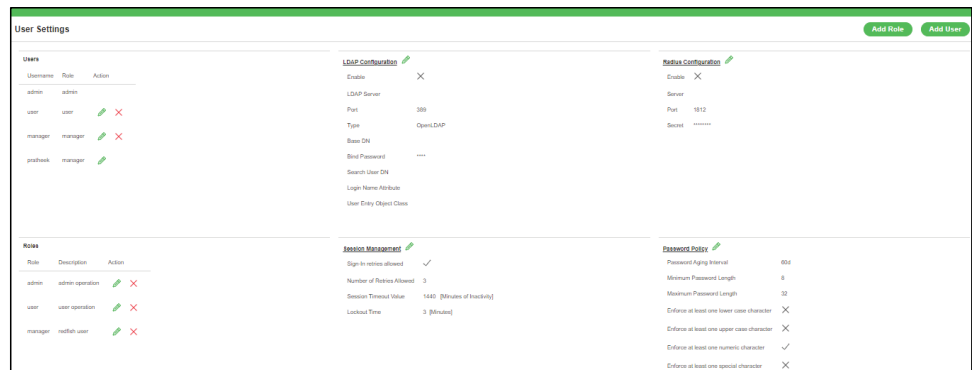

User Settings Add Role Add User

Username	Role	Action
admin	admin	
user	user	
manager	manager	
redfish	manager	

LDAP Configuration

- Enable
- LDAP Server
- Port: 389
- Type: OpenLDAP
- Base DN
- Bind Password
- Search User DN
- Login Name Prefix
- User Entry Object Class

Session Management

- Sign-In retries allowed:
- Number of Retries Allowed: 3
- Session Timeout Value: 1440 (Minutes of Inactivity)
- Lockout Time: 3 (Minutes)

Password Policy

- Password Aging Interval: 90d
- Minimum Password Length: 8
- Maximum Password Length: 32
- Enforce at least one lower case character:
- Enforce at least one upper case character:
- Enforce at least one numeric character:
- Enforce at least one special character:

On the top right corner of the Rack Access control page, you can choose to **Add User** or **Add Role**.

To add Users or change a user’s password:

- Click on the **Add Users** button to open an Add User dialog box.

-
- Add the user information and role.
 - Click on the **Save** button to save the information.

To modify an existing user profile:

- Click on the Edit icon  next to the username you want to modify.
- The **Edit User** dialog box will open.
- Make the changes to the user profile.
- Click on the **Save** button to save the changes.

To delete an existing user profile:

- On the User Settings page, find the username you want to delete.
Select the **X** next to the username you want to delete.

LDAP Server Settings

To setup LDAP to access the Active Directory (AD) and provide authentication when logging into the Rack PDU from the Web UI:

1. On the **User Settings** page, go to the LDAP Configuration tab. Click the Edit icon  to open the Edit dialog box.

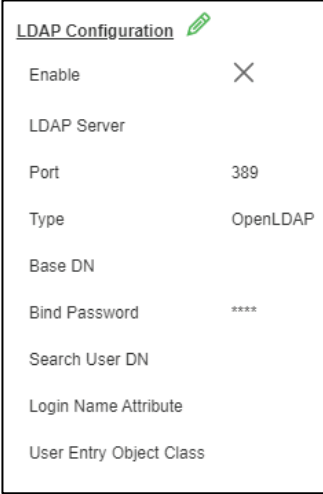

The image shows a dialog box titled "LDAP Configuration" with a pencil icon in the top right corner. It contains several fields: "Enable" with a close button (X), "LDAP Server", "Port" with the value "389", "Type" with the value "OpenLDAP", "Base DN", "Bind Password" with the value "****", "Search User DN", "Login Name Attribute", and "User Entry Object Class".

2. In the Edit dialog box, click the **Enable** button to enable LDAP. You can see that LDAP is enabled when the button is colored green. The button will be gray when not enabled.

3. Click in the **Type** (for Type of LDAP Server) field, select **Open LDAP** from the dropdown menu.

4. Type the Port number in the **Port** field.

NOTE: For Microsoft, this number is typically 389.

5. In the **Base DN** field, type in the account. Example: CN+=myuser, CN=Users, DC=EMEA, DC=mydomain, DC=com

6. In the **Bind Password** field, type in the password. Type the password again in the **Confirm Password** box when it opens, to complete the step.

7. Search User DN. Type in your DN.

8. Type **SAMAccountName** (typically) in the **Login Name Attribute** field.

9. Type **Person Name** in the **User Entry Object Class** field.

10. Click the **Save** button.

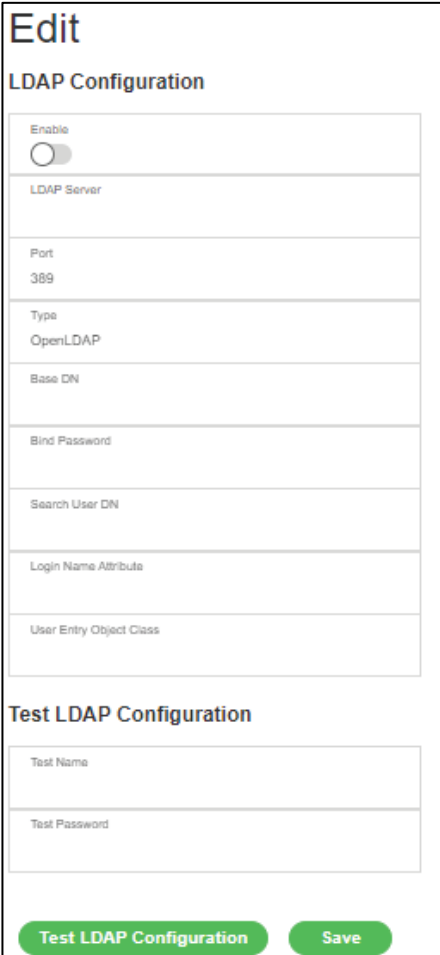

The image shows an "Edit" dialog box for "LDAP Configuration". It has a title bar "Edit" and a subtitle "LDAP Configuration". The form contains: "Enable" with a toggle switch, "LDAP Server", "Port" with the value "389", "Type" with the value "OpenLDAP", "Base DN", "Bind Password", "Search User DN", "Login Name Attribute", and "User Entry Object Class". Below the form is a "Test LDAP Configuration" section with "Test Name" and "Test Password" fields. At the bottom are two buttons: "Test LDAP Configuration" and "Save".

With these LDAP settings configured, the Bind is complete.

Once the LDAP is configured, the Rack PDU must understand for which group authentication occurs. A role must be created on the Rack PDU to reference a group within the Active Directory (AD).

- Within the Web UI, go to **User Settings** and click on the **Add Role** button in the top right corner to open the **Add Role** dialog box.

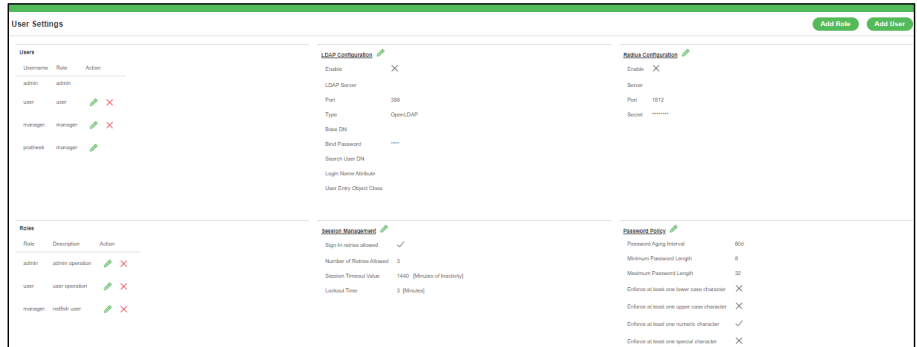

- Enter the Role Name, which was created in the AD (PDUAdmin), in the **Role Name** field.
- In the **Privileges** field, click on the button to enable **Administrator Privileges**.

Add

Role

Privileges

 Administrator Privileges

- Click the **Save** button.

Test LDAP Configuration

Test the setup to determine if LDAP authentication is ready to use.

On the **User Settings** page, click on the **LDAP Configuration** Edit icon  to open the Edit dialog box again.

Type the **Active Directory username/ password** into the test box.

Click the **Test LDAP Configuration** button at the bottom of the dialog box. If a dialog box opens with all green "SUCCEEDED" (and no X's), the LDAP is successfully configured.

Edit

LDAP Configuration

Enable	<input type="checkbox"/>
LDAP Server	
Port	389
Type	OpenLDAP
Base DN	
Bind Password	
Search User DN	
Login Name Attribute	
User Entry Object Class	

Test LDAP Configuration

Test Name	
Test Password	

Radius Configuration

On the **User Settings** page, go to the Radius Configuration tab and click on the Edit icon  to open the **Edit Radius Configuration** dialog box.

- Type the **Server IP address**, **Port number**, and **Secret** in the corresponding field.
- Click the **Save** button to complete the Radius authentication.

Edit

Radius Configuration

Enable	<input type="checkbox"/>
Server	
Port	1812
Secret	

Roles

In User Settings, got to Roles to change the user roles, privileges, and settings.

To create a new role:

- Click the **Add Role** button in the top right corner of the page.
- Type the **Role Name** and **Description**.
- Assign the Privileges.
- Click the **Save** button to save your entry.

Add

Role

Role Name

Description

Privileges

Administrator Privileges

Save

To modify a custom user role:

- Select the role.
- Click on the edit icon to open the **Edit role** dialog box.
- Edit the role name and privileges as needed.
- Click the Save button to save your changes.

Edit

Role

Role Name
admin

Description
admin operation

Privileges
 Administrator Privileges

Save

To delete a user role:

- Select the role.
- Click the **X** icon.
- Click **Yes** to confirm the change

Role	Description	Action
admin	admin operation	
user	user operation	
manager	redfish user	

Session Management

Session management supports the users to manage the Sign-In retries, number of retries allowed, session timeout value, and lockout time.

Click the edit icon to setup the parameters.

Session Management 	
Sign-In retries allowed	✓
Number of Retries Allowed	3
Session Timeout Value	1440 [Minutes of Inactivity]
Lockout Time	3 [Minutes]

Make your changes in the **Edit Session Management** dialog box.

Click the **Save** button to save your changes.

Edit

Session Management

Sign-In retries allowed	<input checked="" type="checkbox"/>
Number of Retries Allowed	3
Session Timeout Value	24 hr
Lockout Time	3 min

Save

Password Policy

You can set a requirement for users to change their password at set intervals using the Password Aging Interval policy. You can also specify criteria for passwords to ensure that your users enter strong passwords.

- Click on the edit icon next to **Password Policy** on the User Settings page.

Password Policy 	
Password Aging Interval	60d
Minimum Password Length	8
Maximum Password Length	32
Enforce at least one lower case character	✗
Enforce at least one upper case character	✗
Enforce at least one numeric character	✓
Enforce at least one special character	✗

- Choose a password aging interval from the **Password Interval** dropdown menu, if desired.
- If you wish to specify password criteria, click on the **Strong Password** radio button to enable.
- Set the **Minimum password Length** and **Maximum Password Length** from the dropdown menus.

NOTE: Minimum password length cannot be less than eight (8) characters and the maximum allowed is 32.

- Click the checkboxes to force users to use specific types of characters within the password.
- Click the **Save** button to save your changes.

Edit

Password Policy

Password Aging Interval	60d
Minimum Password Length	8
Maximum Password Length	32
Enforce at least one lower case character	<input type="radio"/>
Enforce at least one upper case character	<input type="radio"/>
Enforce at least one numeric character	<input checked="" type="radio"/>
Enforce at least one special character	<input type="radio"/>

Save

SNMP

Simple Network Management Protocol (SNMP) is used to manage the Rack PDU(s) remotely. SNMP allows the user to monitor and detect network faults and to configure variable data in the Rack PDU.

Enable SNMP from the Web UI. See SNMP Management in the Web UI section of this manual.

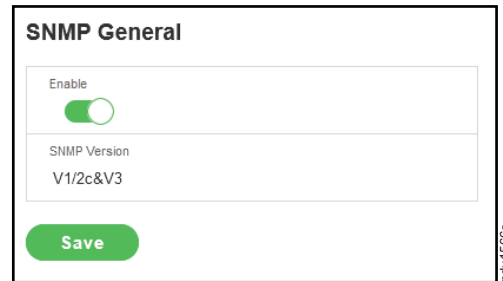

Using an MIB Browser

Download the MIB browser and install it on your computer.

1. Open the MIB browser. Type in the IP address of the Rack PDU.



2. Click the Advanced button to open the Advance Properties of the SNMP Agent window.

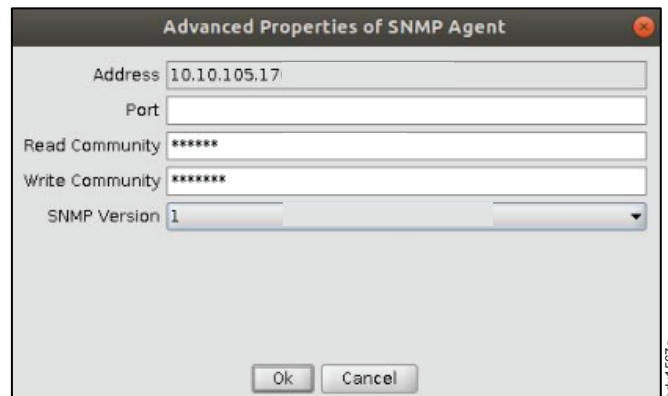

3. In the Advance Properties of SNMP Agent window, enter the respective Port, Read Community, and Write Community.
4. Select the SNMP manager version: **1**, **2**, or **3**.

Loading the MIB File

Click on **File**. Select **Load MIBs** to open the window.

1. Select the latest version of the mib file.
2. Click the Open button to start loading the mib file.

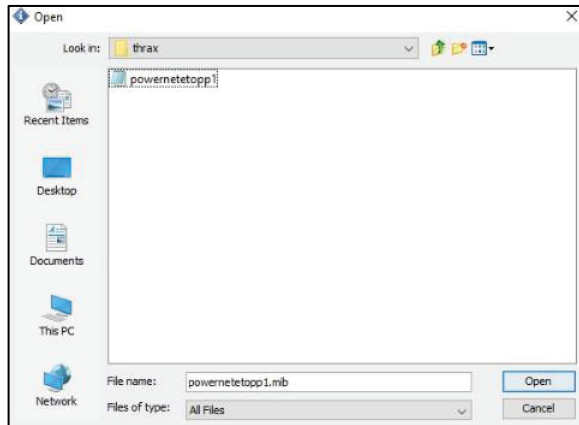

pdu1578a

3. A window displaying the MIB Tree will open. Expand the MIB Tree and select the **iso.org.dod.internet.private.enterprises.apc** file.

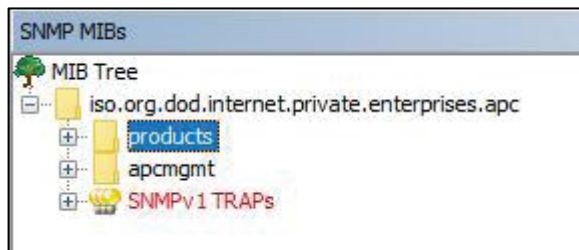

pdu1580a

4. Right click on the **iso.org.dod.internet.private.enterprises.apc** and select **walk** from the dropdown menu to monitor the Rack PDU data.
5. Click on the **+** icon of the **products** folder to open the dropdown menu and select the **dPDU** folder to perform the SNMP functions of the Rack PDU.

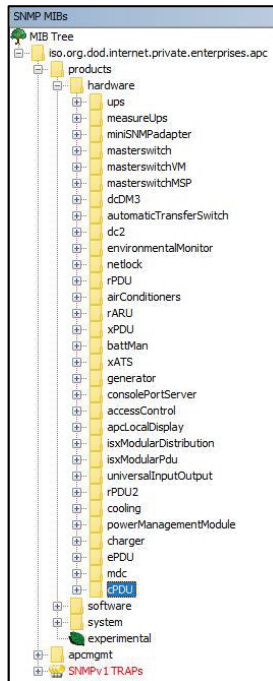

pdu1581a

Redfish

Redfish API can be used to manage your Rack PDUs through an extension app, such as POSTMAN, for GET, POST and DELETE requests. You will need to download the POSTMAN app before performing the task below.

If you use POSTMAN, follow the instructions below to setup Redfish access:

1. To setup Redfish access, type the IP Address of the Rack PDU in a Google Chrome browser to open the login page for the Rack PDU. Login to the Rack PDU using your credentials.
2. Navigate to Network Settings. Enable RESTapi Access Configuration on that page.

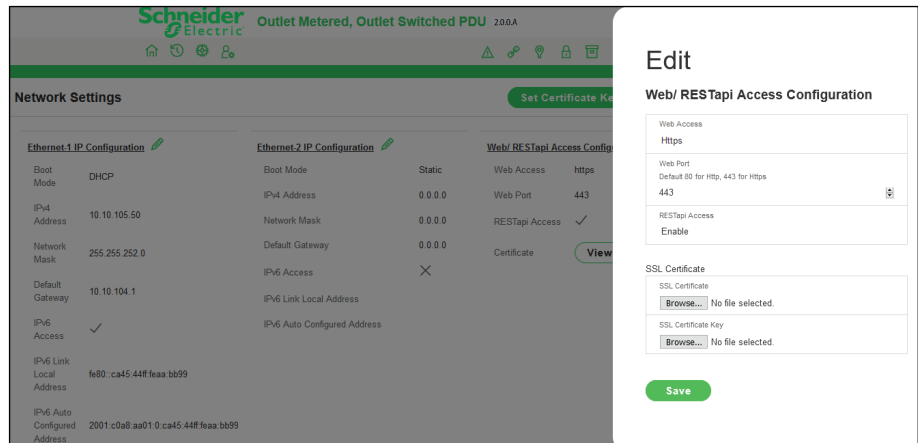

3. Click the **Save** button to confirm and apply your changes.
4. Open the POSTMAN app. Add the basic authentication header, which is required for all the query requests.
 - For a GET request, type the URL request, enter the basic authentication header with your username and password to query the request.

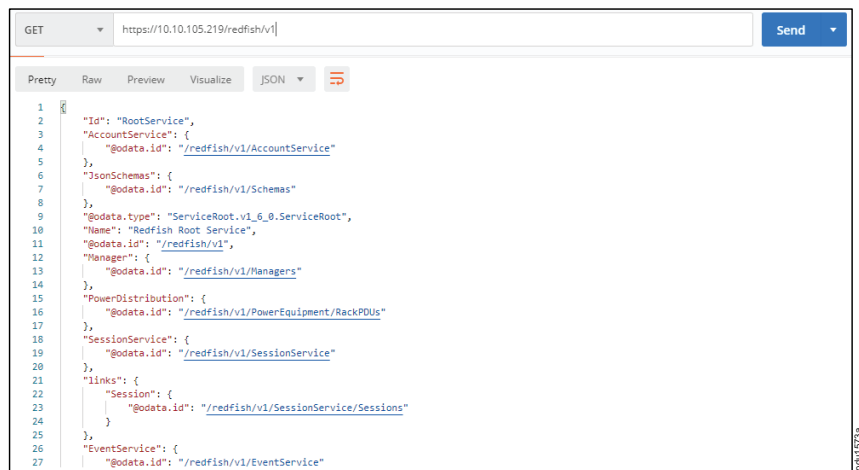

- To make a POST request, you must include the json object type along with the basic authentication header.

NOTE: See the POSTMAN app Web page if you need more information regarding the json object.

- To create a session using POSTMAN:
POST query the URL: **http://{pdu_ip}/redfish/v1/SessionsService/Sessions** along with the two headers (basic auth and json object type) and the body:

```
{
  "username": "admin",
  "password": "123456789"
}
```

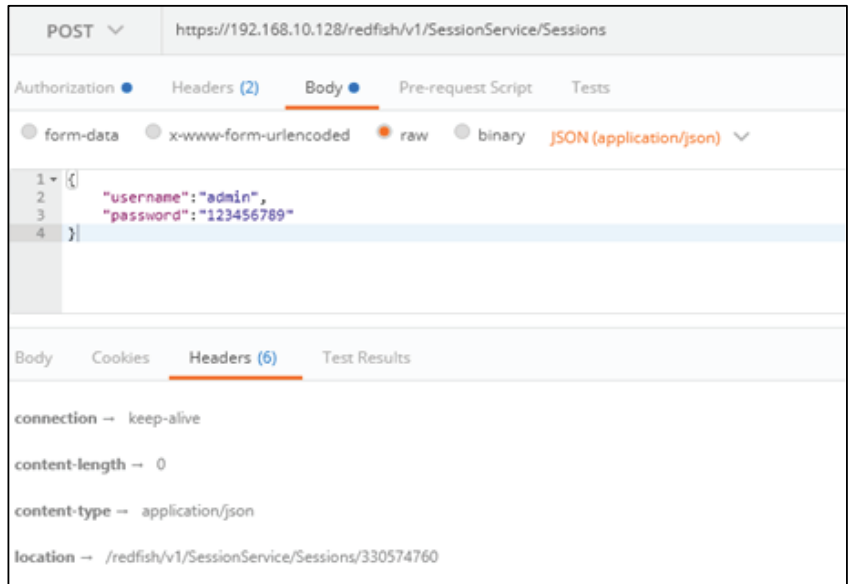

pdut1574a

- Use the X-Auth Token from the response body along with the other two headers and basic authentication for any POST requests.

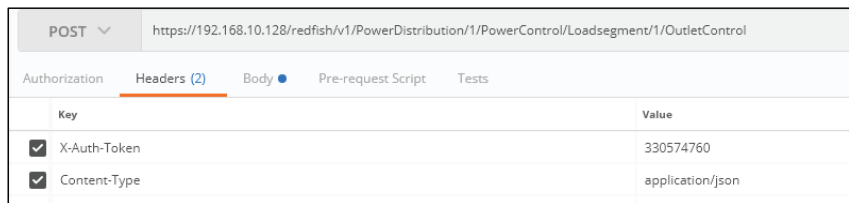

pdut1574b

- To complete a DELETE request, type the URL for the session or users you want to delete and enter your basic authentication (username and password).

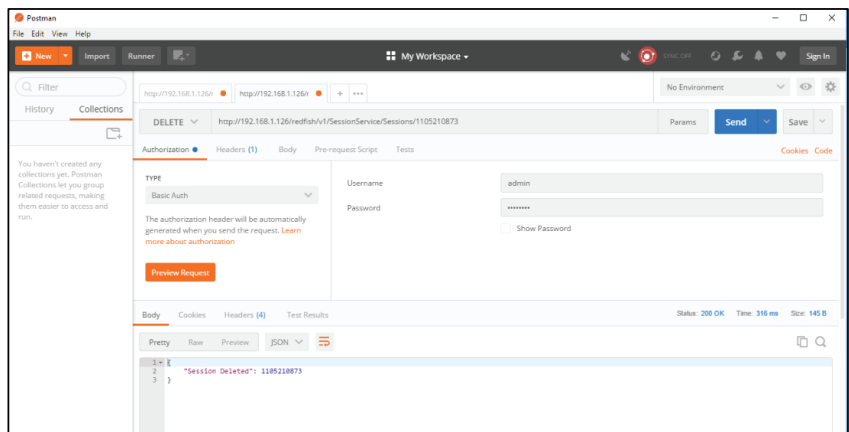

pdut1574c

Redfish URLs Supported with GET Method

Session Service

S. No	URL
1	https://<ip_addr>/redfish/v1/
2	/redfish/v1/SessionService
3	/redfish/v1/SessionService/Sessions
4	/redfish/v1/SessionService/Sessions/{session_ids}

Account Service

S. No	URL
1	/redfish/v1/AccountService
2	/redfish/v1/AccountService/Accounts
3	/redfish/v1/AccountService/Accounts/{username}
4	/redfish/v1/AccountService/Roles
5	/redfish/v1/AccountService/Roles/{rolename}

Managers

S. No	URL
1	/redfish/v1/Managers
2	/redfish/v1/Managers/manager
3	/redfish/v1//Managers/managers/NetworkProtocol
4	/redfish/v1//Managers/1/LogServices
5	/redfish/v1//Managers/1/LogServices/Log
6	/redfish/v1//Managers/1/LogServices/Log/Entries

Metrics

S. No	URL
1	/redfish/v1/PowerEquipment/RackPDUs/{pdu_id}/Metrics

Power Equipment

S. No	URL
1	/redfish/v1/PowerEquipment
2	/redfish/v1/PowerEquipment/RackPDUs
3	/redfish/v1/PowerEquipment/RackPDUs/{pdu_id}

Branches

S. No	URL
1	/redfish/v1/PowerEquipment/RackPDUs/{pdu_id}/Branches
2	/redfish/v1/PowerEquipment/RackPDUs/{pdu_id}/Branches/#cbnumber

Outlets

S. No	URL
1	/redfish/v1/PowerEquipment/RackPDUs/{pdu_id}/Outlets
2	/redfish/v1/PowerEquipment/RackPDUs/{pdu_id}/Outlets/#outletnumber

Sensor

S. No	URL
1	/redfish/v1/PowerEquipment/RackPDUs/{pdu_id}/Sensors/Power{cbnum#}
2	/redfish/v1/PowerEquipment/RackPDUs/{pdu_id}/Sensors/Current{cbnum}
3	/redfish/v1/PowerEquipment/RackPDUs/{pdu_id}/Sensors/VoltageAL1N
4	/redfish/v1/PowerEquipment/RackPDUs/{pdu_id}/Sensors/CurrentOUTLET#
5	/redfish/v1/PowerEquipment/RackPDUs/{pdu_id}/Sensors/VoltageOUTLET#
6	/redfish/v1/PowerEquipment/RackPDUs/{pdu_id}/Sensors/PowerOUTLET#
7	/redfish/v1/PowerEquipment/RackPDUs/2/Sensors/EnergyOUTLET44
8	/redfish/v1/PowerEquipment/RackPDUs/2/Sensors/PowerMains1-6
9	/redfish/v1/PowerEquipment/RackPDUs/2/Sensors/CurrentMains1-3
10	/redfish/v1/PowerEquipment/RackPDUs/2/Sensors/VoltageMains1-6
11	/redfish/v1/PowerEquipment/RackPDUs/2/Sensors/FreqMains
12	/redfish/v1/PowerEquipment/RackPDUs/2/Sensors/PDUPower

Mains

S. No	URL
1	/redfish/v1/PowerEquipment/RackPDUs/{pdu_id}/Mains
2	/redfish/v1/PowerEquipment/RackPDUs/{pdu_id}/Mains/AC1

Redfish URLs Supported with POST Method

S. No	URL
1	/redfish/v1/AccountService/Accounts
2	/redfish/v1/PowerDistribution/{pdu_id}/PowerControl/Loadsegment/{loadseg_id}/OutletControl

Redfish URLs Supported with DELETE Method

S. No	URL
1	/redfish/v1/AccountService/Accounts/test_user
2	/redfish/v1/SessionService/Sessions/<SessionID>

Event Service

Subscribe to Event Service:

1. Using the POST method, create a session and apply the generated X-auth-token to the headers.
2. Query the URL `http://<pdu_ip_addr>/redfish/v1/EventService/Subscriptions` using POST method with the following body:

```
{
  "destination": "http://<ip_addr>/redfish/v1/events",
  "event": "Alert",
  "context": "web",
  "protocol": "redfish"
}
```

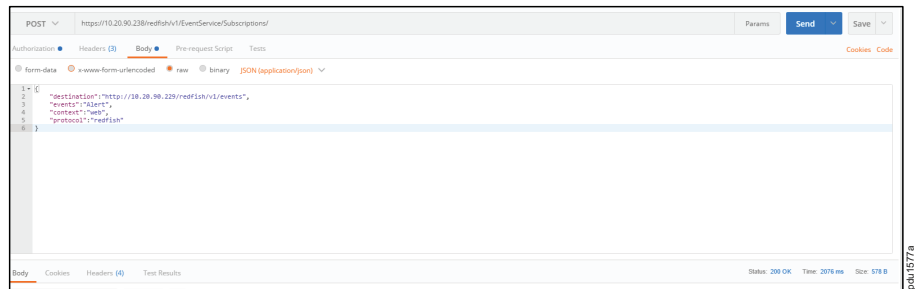

3. To verify the subscriptions, query the URL using the GET method to observe the result of the subscription added: `http://<pdu_ip_addr>/redfish/v1/EventService/Subscriptions/1`

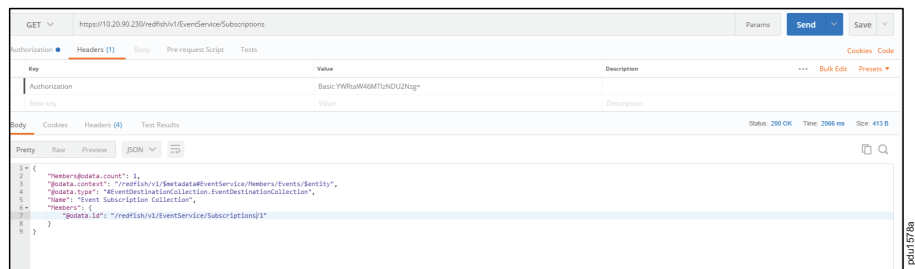

4. To Delete the Subscription, query the URL using the DELETE method to observe the result of the subscription deleted: `http://<pdu_ip_addr>/redfish/v1/EventService/Subscriptions/1`

The Command Line Interface (CLI)

The CLI can be accessed over a serial connection using a program such as HyperTerminal or Putty. See Serial Connection in this manual for more information. You can use the CLI to manage and control the status, parameters, and basic functions of the Rack PDU.

Depending on your access status, you can:

- Reset the Rack PDU
- Display Rack PDU and network properties
- Configure the Rack PDU and network settings
- Switch outlets on or off
- View user information

CLI Commands and Prompts

To display a list of available options in the CLI, type “?” in the command prompt.

The commands are divided into five (5) main categories:

- System setting (sys)
- Network configuration (net)
- User setting (usr)
- Device setting (dev)
- Power (pwr)

CLI Options

To display a list of available menu items in the CLI, type “?” in the command prompt. This will display the main categories of the command options available:

```
apc>?
Sys    PDU system configure and setting
Net    PDU net application configure and setting
Usr    PDU user operation
Dev    PDU device setting
Pwr    PDU power setting
```

To display the options available for a menu item, type the menu command and press the Enter key.

NOTE: you can also type the menu command with “?” to show a list of available commands.

```
parameter Error
sys: system setting
usage:
  sys [date/time/ntp] [2012-09-11/14:16:20/133.100.11.8 133.100.11.9 (server1 server2)]
  sys [ver/def/rst]
  sys upd [pduid] [conf/all]
  sys log [del|edit] [event|data] [on|off] [interval]
  sys ledcolor [pduid]/all] [dark/red/green/yellow/blue/pink/cyan/white]
  sys dualinput get
  sys dualinput set [NA/EMEA]
```

CLI System Commands

The commands are divided into five (5) main categories:

Sys Commands	Description	Example
sys date [yyyy-mm-dd]	Sets the user input date	apc>sys date 2021-08-12 SUCCESS
sys date	Query on the Rack PDU date	apc>sys date SUCCESS Date:2021-08-12 Time:04:58:16
sys time [hh:mm:ss]	Sets the user input time	apc>sys time 09:20:50 SUCCESS
sys time	Query on Rack PDU time	apc>sys time SUCCESS Date:2021:08:12 Time:09:20:53
sys ntp [primary_ip] [secondary_ip]	Sets the NTP	apc>sys ntp 129.6.15.28.129.6.15.29 SUCCESS
sys ver	Query on the system versions — firmware, web, boot loader, and language version	apc>sys ver SUCCESS Firmware Version: 1.0.6.0 Boot loader Version: 1.1 LANGUAGE Version: 1.01 Web Version: 1.0.5.8
sys def	Set the Rack PDU system to default settings	apc>sys def Reboot required for change to take effect System Reboot now, Are you sure? (Y/N):
sys rst	Resets the Rack PDU system	apc>sys rst Reboot required for change to take effect System Reboot now, Are you sure? (Y/N):
sys upd [pduid] [conf/all]	Updates the configuration file	apc>sys upd
sys log [del edit] [event data] [on off] [interval]	Edits the data log configuration interval	apc>sys log edit data on 5 SUCCESS apc>sys log edit data off SUCCESS

CLI Network Commands

Net Commands	Description	Example
net ssh [on/off]	Sets SSH On or Off	apc>net ssh SUCCESS SSH Port: 22 SSH server is running
net ftps [on/off]	Sets FTPS On or Off	apc>net ftps SUCCESS FTPS Port: 21 Service is running Is Ftp
net http [on/off]	Sets HTTP On or Off	apc>net http SUCCESS HTTPS Port: 80 Status: ON apc>net https on Reboot required for change to take effect WEB protocol is changed, reboot to validate System Reboot now, Are you sure? (Y/N):

net https [on/off]	Sets HTTPS On or Off	apc>net https SUCCESS HTTPS Port: 443 Status: OFF apc>net https on Reboot required for change to take effect WEB protocol is changed, reboot to validate System Reboot now, Are you sure? (Y/N):
net redfish [on/off]	Sets Redfish On or Off	apc>net redfish SUCCESS Status: ON apc>net redfish off SUCCESS Status: OFF
net [snmp] [v1v2c/v3/trap] [on/off]	Sets SNMP On or Off	apc>net snmp SUCCESS v1v2c: ON v3: ON trap: ON apc>net snmp v1v2c off SUCCESS
net [mac/tcpip]	Displays the MAC address, IPv4	apc>net mac SUCCESS MAC Addr: C8-45-44-66-2B-65 MAC Addr: C8-45-44-66-2B-67 apc>net tcpip SUCCESS eth0 IPv4 Addr: 10.10.105.37 eth0 IPv6 Link Local Addr: fe80:ca45:44ff:fe66:2b65 eth0 IPv6 DHCP Addr: 2001:c0a8:aa01:0:ca45:44ff:fe66:2b65 eth1 IPv4 Addr: 192.168.2.2
net tcpip [eth0dhcp/eth1dhcp/eth0static/eth1static ip nm gw]	Changes the network to DHCP or Static mode	apc>net tcpip dhcp eth0dhcp Reboot required for change to take effect. Network is reconfigured, reboot to validate System Reboot now, Are you sure? (Y/N):Y
net ip [v4] [v4v6]	Sets IPv4	apc>net ip SUCCESS IPV4 apc>net ipv4 Reboot required for change to take effect. IP protocol is changed, rboot to validate System Reboot now, Are you sure? (Y/N):

net phy [auto/ 10100mbps]	Set the link speed to auto negotiation/10100mbps	apc>net phy SUCCESS link speed: auto negotiation apc>net phy 10100mbps Reboot required for change to take effect Phy speed is changed, reboot to validate System Reboot now, Are you sure?(Y/N):
net cert [def]	Updates the certificate file	apc>net cert SUCCESS Custom certificate key file active, in /cert/cert.key Custom certificate cert file active, in /cert/cert.crt apc>net cert def Removing custom certificate key file, in/cert/cert.key Removing custom certificate key file, in /cert/cert.crt Reboot required for change to take effect Certificate Setting changed, reboot to validate System Reboot now, Are you sure>(Y/N):

CLI User Commands

Usr Commands	Description	Example
usr list	Lists the Rack PDU users	apc>usr list SUCCESS Usr Role Privilege Role id ----- === admin admin Administrator 1 user user User 2 manager manager Administrator 3
usr login	Displays the logged in user details	apc>usr login SUCCESS username: admin ip address: 10.10.94.211 client type: SSH
us unlock [username]	Unlocks the blocked user	apc>usr unlock en_user SUCCESS

CLI Device Commands

Dev Commands	Description	Example
dev cascade [rna] [init] [create]	Setting the Rack PDU Cascade to RNA mode.	apc>dev cascade SUCCESS Cascade unit number: 1 Cascade address list: 0 0 0 Cascade Mode: RNA apc>dev cascade qna create Reboot required for change to take effect System Reboot now, Are you sure?(Y/N):
dev outlet pdu ID [status/ outlet index] [on/off]	Displays outlet status. Turn On or Off the outlet power.	apc>dev outlet 1 status SUCCESS Relay Outlet Status Outlet# 1: Open Outlet# 2: Open Outlet# 3: Open Outlet#4: Open Outlet# 5: Open

		Outlet#6: Open Outlet# 7: Open Outlet# 8: Open apc>dev outlet 11 on SUCCESS
dev [sensor/usb] [on/off]	Lists out the connected sensors on the Rack PDU. Turn the USB On or Off	apc>dev sensor SUCCESS apc>dev usb on SUCCESS
dev ledstrip [on/off]	Turn the ledstrip On or Off	apc>ledstrip on SUCCESS
dev powershare	Displays the status of the Rack PDU power share.	apc>dev power share SUCCESS PDU 1: Downstream: 0 Upstream: 1 Mains: 1 PDU 2: Downstream: 1 Upstream: 1 Mains: 1 PDU 3: Downstream: 1 Upstream: 1 Mains: 1

CLI Power Commands

Dev Commands	Description	Example
pwr [unit/phase/ cb/outlet] [idx]	Displays the power readings	apc>pwr unit 1 SUCCESS UNIT power Feature voltage: 0V current: 0.0A active power: 0W power factor: 1.00 energy: 0.000kWh apc>pwr outlet 3 SUCCESS OUTLET 3 power Feature voltage:0V current: 0.0A active power: 0W apparent power: 0W

Cascading Rack PDUs and Redundant Network Access (RNA)

In cascade mode, up to 32 Rack PDUs can be connected using one (1) IP address. Information and data from all Guest Rack PDUs is gathered from the Host Rack PDU.

Cascade functionality reduces the network services cost for Rack PDUs. For example, a standard network switch is used in a data center can contain 24 ports. Without using the cascade function each port supplies network services to one (1) Rack PDU. Using the cascade features, a typical network switch with 24 ports can supply network services for up to 768 Rack PDUs.

Setup the Rack PDUs

Connect up to 32 Rack PDUs of the same SKU from a single IP address:

1. Configure the Rack PDU which will be the first in line (the Host).
NOTE: Refer to Establish Network Settings in this manual for more information.
2. After the Host Rack PDU is configured, connect the Ethernet cable from the 10/100 port on the Host Rack PDU to the 10/100/1000 port on the Rack PDU which will be the next in line.
3. Continue connect your Rack PDUs from the 10/100 port to the 10/100/1000 port for up to 32 Rack PDUs.
NOTE: The length of the Ethernet cables connecting the Rack PDUs must be less than 6m (20 ft).
4. By default, the Cascade command is enabled in the Rack PDU configuration file and default mode of the Rack PDU is RNA. Go to the Web UI (or your management software) to manage and control the Rack PDUs in the Cascade.

Redundant Network Access (RNA) Functionality

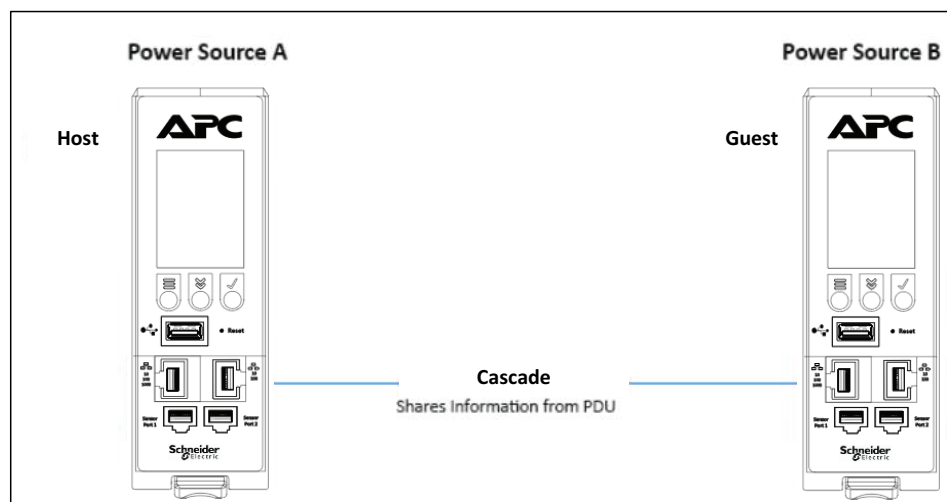

The Redundant Network Access allows secure access of Rack PDU data and statistics on two (2) separate private networks. RNA is used with a redundant power delivery design including two (2) Rack PDUs for each IT rack. The Rack PDUs must be the same SKUs when used in RNA applications.

How RNA Works

- RNA maintains two separate private networks (Landlord and Tenant) that do not overlap.
- RNA works using a redundant power delivery design (that is, two Rack PDUs for each IT rack).
- Each Rack PDU is separately connected to the Landlord or Tenant's private communications network.

-
- The two Rack PDUs are connected with a data communications bus to allow the Rack PDUs to share user-defined information.
 - Each Rack PDU acts like a Host Rack PDU to report Rack PDU data to both networks.

Setup RNA on the Rack PDUs

To setup RNA on cascaded Rack PDUs, the user must:

1. Configure the Rack PDU for RNA using the CLI.
 - Login to the CLI and type: `dev cascade rna` on the last Rack PDU in the cascade.
 - The response will be:
`SUCCESS`
`System Reboot now, Are you Sure?(Y/N) :`
 - Type `Y` to confirm the reboot.
 - After the reboot is complete, the Rack PDU will be set to RNA mode.
NOTE: Do not place RNA enabled Rack PDUs in among Rack PDUs in a cascaded system.
2. Connect the LAN Network cables and Ethernet cables between the Rack PDUs.

After the Rack PDUs are configured for RNA:

1. Connect the LAN network cable from the network switch to the 10/100/1000 port (GB port) on Rack PDU #1.
2. Connect an Ethernet cable from the 10/100 port (MB port) of Rack PDU #1 to the 10/100/1000 port (GB port) to the next Rack PDU to cascade.
3. Connect another LAN network cable from the network switch to the 10/100 port (MB port) to the nth (last) Rack PDU in the cascade.

Firmware Update Procedures

Update Using USB

NOTICE

The USB method for updating firmware is for standalone Rack PDUs **ONLY**.
Failure to follow these instructions can result in equipment damage.

1. Go to www.apc.com and download the most recent firmware version, **apc.fw**.
2. Extract the **apc.fw** and copy its contents to the USB.

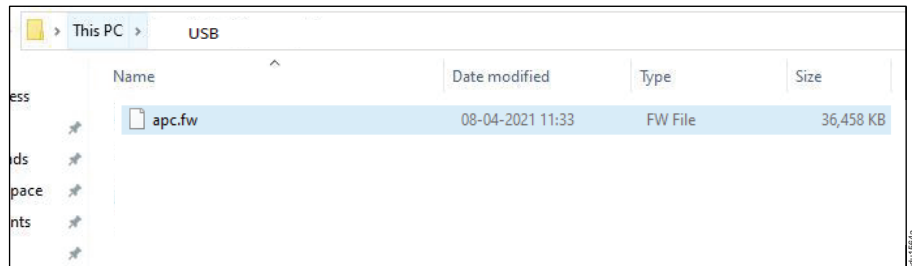

3. Insert the USB drive into the USB port on the Rack PDU.
4. Go to Settings>USB on the LCD display of the Rack PDU.
5. Select Firmware Upload from the menu and select Yes to confirm.
NOTE: The LCD display will show the Firmware update progress. When the update is complete, the Rack PDU will automatically reboot.
6. Remove the USB drive from the Rack PDU.
7. Go to Settings>Device>Firmware to confirm that the firmware uploaded successfully.

Update Using the Web UI

1. Go to **www.apc.com** and download the most recent firmware version, **apc.fw**. Save the file to a folder located on your computer.
2. Go to the System management page in the Web UI and select the Upload Firmware option.
3. Select the Rack PDU to which you want to upload the firmware and upload the **apc.fw** file.

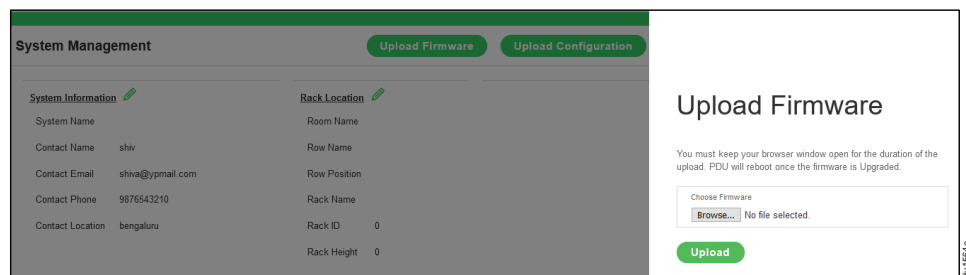

NOTE:

- If you have standalone Rack PDUs: The Rack PDU will reboot and the firmware upgrade will complete automatically.
- If you have a system of cascaded Rack PDUs: A window will open to prompt you to restart your system when the firmware has been updated on all the Rack PDUs.

Update Using FTPS

To access the Rack PDU using an FTPS program, FTPS must be enabled through the Web UI, the CLI or through SSH.

1. In the Web UI, go to Network Settings > FTPS.
2. Select the check box **Enable FTPS Access**.
3. Login to an FTP program. You must have a role with administration privileges.
4. Download the **apc.fw** firmware file from **www.apc.com**. Transfer the firmware file to an **fw** folder accessible by the FTP program.
5. Connect to the Rack PDU using an SSH program such as HyperTerm or PUTTY.
6. Login using a role with administration privileges.
7. Type the command `sys upd <pduid> all` to start the upload. After you receive the reboot message, type `sys upd <pduid> rst` in the console window. (In Cascade for the guest device.)

NOTE: For a Host Rack PDU or standalone configuration, type the command `sys upd <pduid> all`

The (Y/N) prompt will appear for the Rack PDU to reboot. Type `y`. When the upload is finished, the system will reboot automatically.

Troubleshooting

Rack PDU Access Problems

For problems that persist or are not described here, contact APC Customer Support at www.apc.com.

Problem	Solution
Cannot allocate the communications port through a terminal program	Before you can use a terminal program to configure the Rack PDU, you must shut down any application, service, or program using the communications port.
Cannot access the Command Line Interface remotely	Make sure you are using the correct access method.
Cannot access the Web UI	<ul style="list-style-type: none">• Verify that HTTP or HTTPS access is enabled.• Verify that you are using a Web browser supported for the Rack PDU. <p>NOTE: Check the specific error message reported by the browser. It may indicate the specific problem.</p>

SNMP Issues

Problem	Solution
Unable to perform a GET	Verify the read (GET) community name (SNMPv1) or the user profile configuration (SNMPv3).
Unable to perform a SET	<ul style="list-style-type: none">• Verify that SNMP is enabled.• Verify the read/write (SET) community name (SNMPv1) or the user profile configuration (SNMPv3).• Use the CLI or Web UI to ensure that write (SET) access (SNMPv1) has been enabled or access is granted to the target IP address through the access control list (SNMPv3).
Unable to receive traps	<ul style="list-style-type: none">• Make sure the trap type (SNMPv1 or SNMPv3) is correctly configured as a trap receiver.• For SNMPv1, query the MIB OID to verify that the IP address is listed correctly and that the community name defined matches the community name in the table. If either is not correct, use SETs to the OIDS, or use the CLI or Web UI to correct the trap receiver definition.• For SNMPv3, check the user profile configuration and run a trap test.
Traps received are not identified	Verify that the traps are properly integrated in the alarm/trap database.

Source Code Copyright Notice

cryptlib copyright Digital Data Security New Zealand Ltd 1998.
Copyright © 1990, 1993, 1994 The Regents of the University of California. All rights reserved.

This code is derived from software contributed to Berkeley by Mike Olson.

Redistribution and use in source and binary forms, with or without modification, are permitted provided the following conditions are met:

1. Redistributions of source code must retain the above copyright notice, this list of conditions and the following disclaimer.
2. Redistributions in binary form must reproduce the above copyright notice, this list of conditions and the following disclaimer in the documentation and/or other materials provided with the distribution.
3. All advertising materials mentioning features or use of this software must display the following acknowledgment: This product includes software developed by the University of California, Berkeley and its contributors.
4. Neither the name of the University nor the names of its contributors may be used to endorse or promote products derived from this software without specific prior written permission.

THIS SOFTWARE IS PROVIDED BY THE REGENTS AND CONTRIBUTORS "AS IS" AND ANY EXPRESS OR IMPLIED WARRANTIES, INCLUDING, BUT NOT LIMITED TO, THE IMPLIED WARRANTIES OF MERCHANTABILITY AND FITNESS FOR A PARTICULAR PURPOSE ARE DISCLAIMED. IN NO EVENT SHALL THE REGENTS OR CONTRIBUTORS BE LIABLE FOR ANY DIRECT, INDIRECT, INCIDENTAL, SPECIAL, EXEMPLARY, OR CONSEQUENTIAL DAMAGES (INCLUDING, BUT NOT LIMITED TO, PROCUREMENT OF SUBSTITUTE GOODS OR SERVICES; LOSS OF USE, DATA, OR PROFITS; OR BUSINESS INTERRUPTION) HOWEVER CAUSED AND ON ANY THEORY OF LIABILITY, WHETHER IN CONTRACT, STRICT LIABILITY, OR TORT (INCLUDING NEGLIGENCE OR OTHERWISE) ARISING IN ANY WAY OUT OF THE USE OF THIS SOFTWARE, EVEN IF ADVISED OF THE POSSIBILITY OF SUCH DAMAGE.

APC
70 Mechanic Street
02035 Foxboro, MA
USA

www.apc.com

As standards, specifications, and design change from time to time,
please ask for confirmation of the information given in this publication.

© 2022 – Schneider Electric. All rights reserved.

990-91564