



User Guide

Omada Controller Software

1910012573 REV 3.3.0

May 2019

CONTENTS

1 Quick Start	1
1.1 Determine the Network Topology	2
1.1.1 Management on the local Network.....	2
1.1.2 Management via Cloud Access.....	4
1.2 Install Omada Controller Software	5
1.2.1 Installation on Windows Host.....	5
1.2.2 Installation on Linux Host	5
1.3 Inform the EAPs of the Controller Host's Address	7
1.4 Start and Log In to the Omada Controller	8
1.4.1 Launch Omada Controller	8
1.4.2 Do the Basic Configurations.....	9
1.4.3 Log In to the Management Interface.....	12
1.5 Create Sites and Adopt EAPs	12
1.5.1 Create Sites	13
1.5.2 Adopt the EAPs	15
1.6 Monitor and Manage the EAPs.....	16
2 Monitor and Manage the Network	18
2.1 View the Statistics of the Network	19
2.1.1 View the Client Distribution on SSID	19
2.1.2 Have a Quick Look at EAPs and Clients.....	19
2.1.3 View Current Usage-Top EAPs	20
2.1.4 View Recent Activities	20
2.2 Monitor the Network with the Map	21
2.2.1 Add a Map.....	21
2.2.2 Monitor the EAPs on the Map	24
2.3 Monitor and Manage the EAPs.....	25
2.3.1 Manage the EAPs in Different Status.....	25

2.3.2	View the Detailed Information of EAPs.....	26
2.3.3	Manage the EAPs in the Action Column	26
2.4	Monitor and Manage Clients	28
2.4.1	View the Current Information of Clients	28
2.4.2	Manage Clients in the Action Column.....	28
2.5	View Clients Statistics During the Specified Period	29
2.5.1	Select a Specified Period	29
2.5.2	View the History Information of Clients	30
2.5.3	Manage Clients in the Action Column.....	30
2.6	Manage the Rogue APs List	30
2.6.1	Manage the Untrusted Rogue APs List	31
2.6.2	Manage the Trusted Rogue APs List.....	31
2.7	View Past Guest Authorization.....	32
2.8	View Logs.....	32
3	Configure the EAPs Globally	34
3.1	Wireless Network.....	35
3.1.1	Add Wireless Networks.....	35
3.1.2	Configure Advanced Wireless Parameters	45
3.1.3	Configure Band Steering	47
3.1.4	Configure Mesh.....	48
3.2	Access Control	53
3.3	Portal Authentication.....	54
3.3.1	No Authentication.....	55
3.3.2	Simple Password	59
3.3.3	Local User.....	63
3.3.4	Voucher	71
3.3.5	SMS.....	78
3.3.6	Facebook.....	83
3.3.7	External RADIUS Server	84

3.3.8	External Portal Server	90
3.4	Free Authentication Policy	91
3.5	MAC Filter	92
3.6	Scheduler	94
3.7	QoS.....	96
3.8	Site Settings	99
3.8.1	LED.....	99
3.8.2	Device Account.....	99
3.8.3	Reboot Schedule	100
3.8.4	Log Settings	100
3.8.5	Batch Upgrade.....	102
3.8.6	SSH	104
3.8.7	Management VLAN.....	105
4	Omada Cloud Service	106
4.1	Configure the Cloud Access.....	107
4.1.1	Enable Cloud Access	107
4.1.2	Manage the Cloud Users	107
4.2	Manage the Controller via Omada Cloud	109
4.2.1	Access the controller via Omada Cloud	110
4.2.2	Change your TP-Link ID information.....	112
5	Configure the EAPs Separately	113
5.1	View the Information of the EAP.....	114
5.1.1	Active Channel Information	114
5.1.2	Overview	115
5.1.3	LAN.....	115
5.1.4	Radio.....	116
5.2	View Clients Connecting to the EAP.....	116
5.2.1	User.....	116
5.2.2	Guest.....	117

5.3	View Mesh Information of the EAP	117
5.3.1	Uplinks	117
5.3.2	Downlinks	118
5.4	Configure the EAP	118
5.4.1	Basic Config.....	118
5.4.2	IP Setting.....	119
5.4.3	Radio.....	120
5.4.4	Load Balance.....	121
5.4.5	WLANs	122
5.4.6	LED	122
5.4.7	Trunk Settings (Only for EAP330).....	123
5.4.8	Rogue APs Detection.....	123
5.4.9	Local LAN Port Settings (Only for EAP115-Wall and EAP225-Wall)	124
5.4.10	Forget this AP	124
6	Manage the Omada Controller	125
6.1	User Account.....	126
6.2	General Setting	127
6.2.1	Configure Controller Name.....	127
6.2.2	Configure Mail Server	127
6.3	History Data Retention.....	129
6.4	Backup&Restore.....	130
6.5	Auto Backup.....	130
6.6	Migrate	133
6.6.1	Controller Migrate	133
6.6.2	Site Migrate.....	137
6.7	Information About the Software.....	141
7	Application Example	142
7.1	Basic Configuration.....	143
7.2	Advanced Settings	143

7.2.1	Monitor the EAPs with Map.....	143
7.2.2	Configure Portal Authentication.....	144
7.2.3	Create a SSID for the Employees.....	146
7.2.4	Configure Scheduler.....	147
Appendix: Omada App		149
1	Install Omada App on the Mobile Device	150
2	Manage your Network in Standalone Mode	150
3	Manage your Network in Controller Mode.....	153
3.1	Locally manage your EAPs using the Omada App	153
3.2	Remotely manage your EAPs using the Omada App	156

1

Quick Start

Omada Controller is a management software for TP-Link EAPs. With this software, you can centrally manage your EAPs, such as configure EAPs in batches and conduct real-time monitoring of EAPs locally or remotely through Omada Cloud service.

Follow the steps below to complete the basic settings of Omada Controller.

1. Determine the Network Topology
2. Install Omada Controller Software
3. Inform the EAPs of the Controller Host's Address
4. Start and Log In to the Omada Controller
5. Create Sites and Adopt the EAPs
6. Monitor and Manage the EAPs

1.1 Determine the Network Topology

There are two methods to centrally manage EAPs via Omada Controller:

- Management on the Local Network
- Management via Cloud Access

Determine your management method according to your need and refer to the following introductions to build your network topology.

Tips:

Omada app offers a convenient way to access the Omada Controller and adopt EAPs. With Local Access and Cloud Access function on the Omada app, you can manage the controller at local and remote sites. For more detailed information about Omada app, refer to [Appendix: Omada App](#).

1.1.1 Management on the local Network

There are two kinds of network topologies to centrally manage EAPs on the local network:

- Omada Controller and EAPs are in the same subnet.
- Omada Controller and EAPs are in different subnets.

Determine your management method according to your need and refer to the following introductions to build your network topology.

Management in the Same Subnet

If your Omada Controller and EAPs are in the same subnet, refer to the following network topology.

A router acts as a DHCP server to assign IP addresses to EAPs and clients. Omada Controller should be installed on one host, which is called as Controller Host. The other hosts in the same LAN can access the Controller Host to manage the network. Taking the following topology as an example, you can enter "https://192.168.0.100:8043" in a web browser on Host B to visit the Omada Controller interface on Host A. It's recommended to set a static IP address to the Controller Host for the convenient login to the Omada Controller interface.

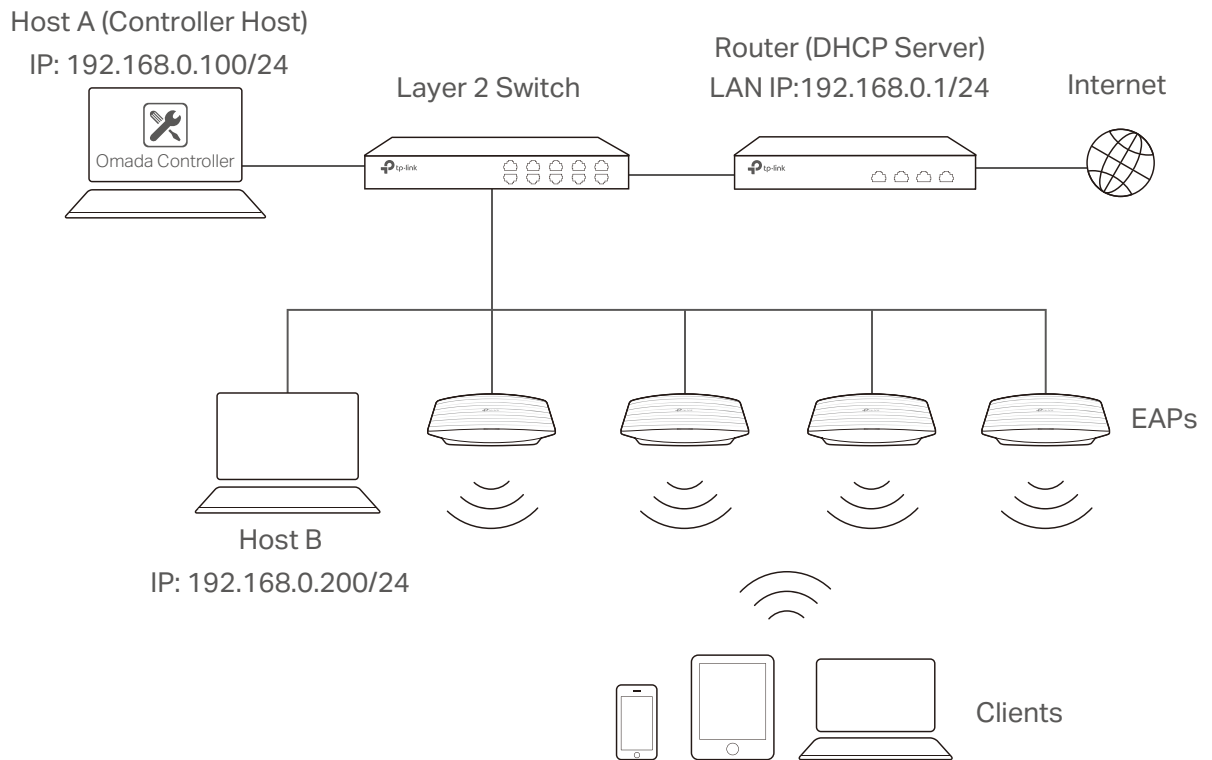

Note:

- Omada Controller must be running all the time when you manage the network.
- Omada Controller can be running on only one host in a LAN. When other users in the LAN try to launch Omada Controller on their own hosts, they will be redirected to the host that is already running Omada Controller.

Management in Different Subnets

If your Omada Controller and EAPs are in different subnets, refer to the following topology.

A router acts as the gateway of the network. A layer 3 switch acts as a DHCP server to assign IP addresses to EAPs and clients. The Controller Host and the EAPs are connected to the switch's different network segments. To help EAPs find the Controller Host, Omada Discover Utility should be installed on Host B which is in the same subnet with the EAPs. For how to use Omada Discovery Utility, refer to [Inform the EAPs of the Controller Host's Address](#).

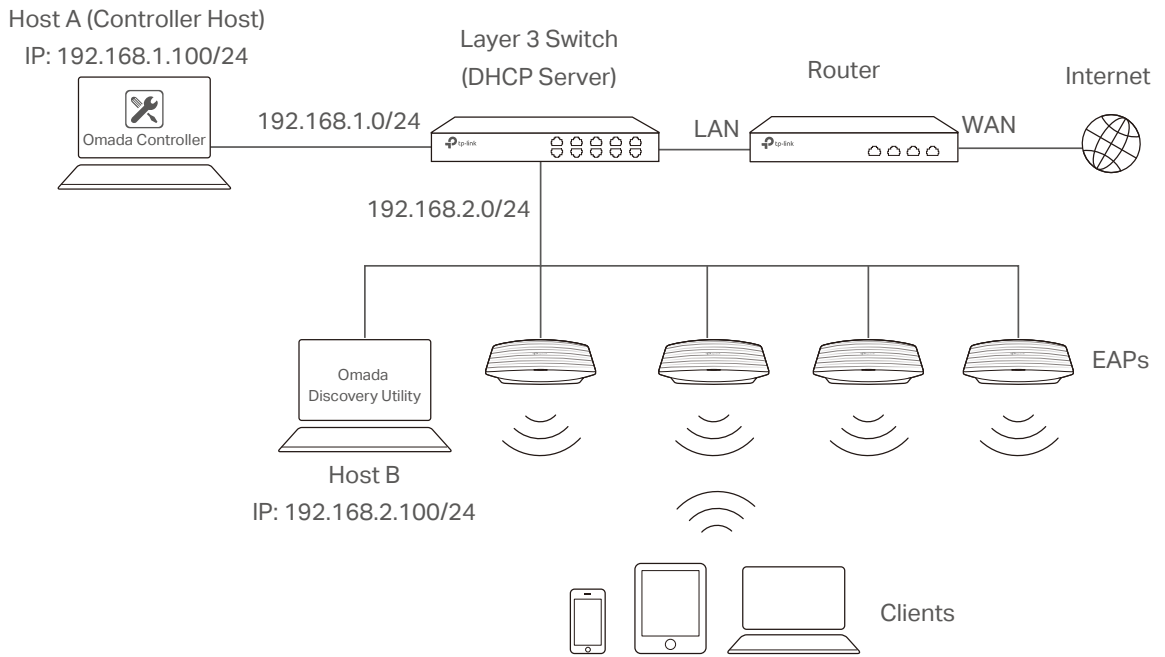

1.1.2 Management via Cloud Access

With Cloud Access enabled on the Omada Controller, you can use <https://omada.tp-linkcloud.com> to remotely access and monitor multiple controllers. If you want to manage EAPs remotely via Omada Cloud, refer to the following topology.

A router acts as the gateway of the network. A Layer 3 switch acts as a DHCP server to assign IP addresses to EAPs and clients. The management device is not on the local network. On the management device, you can launch a web browser to remotely launch Omada Controller to manage EAPs via Omada Cloud. For more details about Cloud Access, refer to [Omada Cloud Service](#).

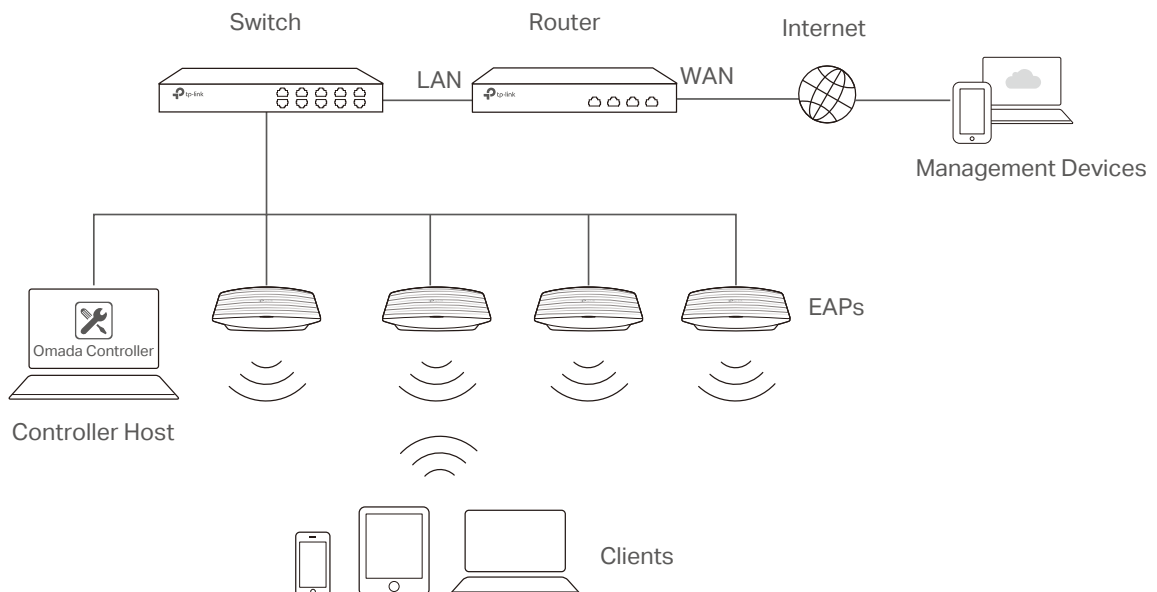

1.2 Install Omada Controller Software

We provide Omada Controller for both Windows and Linux operating systems. Determine your operation system and follow the introductions below to install Omada Controller.

1.2.1 Installation on Windows Host

Make sure your PC meets the following system requirements and then properly install the Omada Controller software.

System Requirements

Operating System: Microsoft Windows 7/8/10/Server.

Web Browser: Mozilla Firefox 32 (or above), Google Chrome 37 (or above), Opera 24 (or above), or Microsoft Internet Explorer 11 (or above).

Note:

We recommend that you deploy Omada Controller on a 64-bit operating system to guarantee the software stability.

Install Omada Controller

Download the installation file of Omada Controller from the website <https://www.tp-link.com/en/download/EAP-Controller.html>. Then follow the instructions to properly install the Omada Controller software. After successful installation, a shortcut icon  of the Omada Controller will be created on your desktop.

1.2.2 Installation on Linux Host

Two versions of installation package are provided: **.tar.gz** file and **.deb** file. The **.tar.gz** file can be used in multiple versions of Linux operating system. And the **.deb** file can be used in Ubuntu and Debian.

Make sure your PC meets the following system requirements and then choose the proper installation files to install the Omada Controller software.

System Requirements

Operating System: 64-bit Linux operating system, including Ubuntu 14.04/16.04/17.04, CentOS 6.x/7.x, Fedora 20 (or above) and Debian 9.8.

Web Browser: Mozilla Firefox 32 (or above), Google Chrome 37 (or above), Opera 24 (or above), or Microsoft Internet Explorer 11 (or above).

Install the Omada Controller

Download the installation file of Omada Controller from our website <https://www.tp-link.com/en/download/EAP-Controller.html>.

Make sure you have **jsvc** and **curl** installed in your system before installation, which is vital to the smooth running of the system. If your system does not have **jsvc** or **curl** installed, you can install it manually with the command: **apt-get install** or **yum install**. For example, you can use the command: **apt-get install jsvc** or **yum install jsvc** to get **jsvc** installed. And if dependencies are missing, you can use the command: **apt-get -f install** to fix the problem.

■ Install the .tar.gz file

Follow the steps below to install Omada Controller on your Linux PC:

1. Make sure your PC is running in root mode. You can use this command to enter root mode:

```
sudo
```

2. Extract the tar.gz file using the command:

```
tar zxvf Omada_Controller_v3.0.5_linux_x64_targz.tar.gz
```

3. Install Omada Controller using the command:

```
sudo./install.sh
```

■ Install the .deb file

Follow the steps below to install Omada Controller on your Linux PC:

1. Make sure your PC is running in root mode. You can use this command to enter root mode:

```
sudo
```

2. Install the .deb file using the command:

```
dpkg -i Omada_Controller_v3.0.5_linux_x64.deb
```

Tips:

- For installing the .tar.gz, if you want Omada Controller to run as a user (it runs as root by default) you should modify OMADA_USER value in bin/control.sh.
- To uninstall Omada Controller, go to the installation path: /opt/tplink/EAPController, and run the command: `sudo ./uninstall.sh`.
- During uninstallation, you can choose whether to backup the database. The backup folder is /opt/tplink/eap_db_backup.
- During installation, you will be asked whether to restore the database if there is any backup database in the folder /opt/tplink/eap_db_backup.

1.3 Inform the EAPs of the Controller Host's Address

If your Controller Host and EAPs are in the same network segment, you can skip this section.

If your Controller Host and EAPs are in different subnets, you need to install Omada Discovery Utility on a host that is in the same network segment with the EAPs. Omada Discovery Utility can help EAPs find the Controller Host.

System Requirements

Windows 7/8/10/Server

Mac OS X 10.7/10.8/10.9/10.10/10.11

Install and Use Omada Discovery Utility

Follow the steps below to install Omada Discovery Utility and use it to inform the EAPs of the Controller Host's IP address:

1. Download the installation file with the latest version from the website https://www.tp-link.com/en/download/EAP-Controller.html#EAP_Discovery_Tool.
2. Make sure you have **JRE (Java Runtime Environment)** with version 1.8 installed on your system before installation. If your system loses **JRE**, download **JRE** from the website <https://www.oracle.com/technetwork/java/javase/downloads/jre8-downloads-2133155.html> and install it on your system.
3. For Windows OS, run the **start-omada-discovery-utility.bat** to open the Omada Discovery Utility. For Mac OS, use the command **java -jar **** to open the Omada Discovery Utility. Then the following window will pop up. This window shows the information of all EAPs in the same LAN.

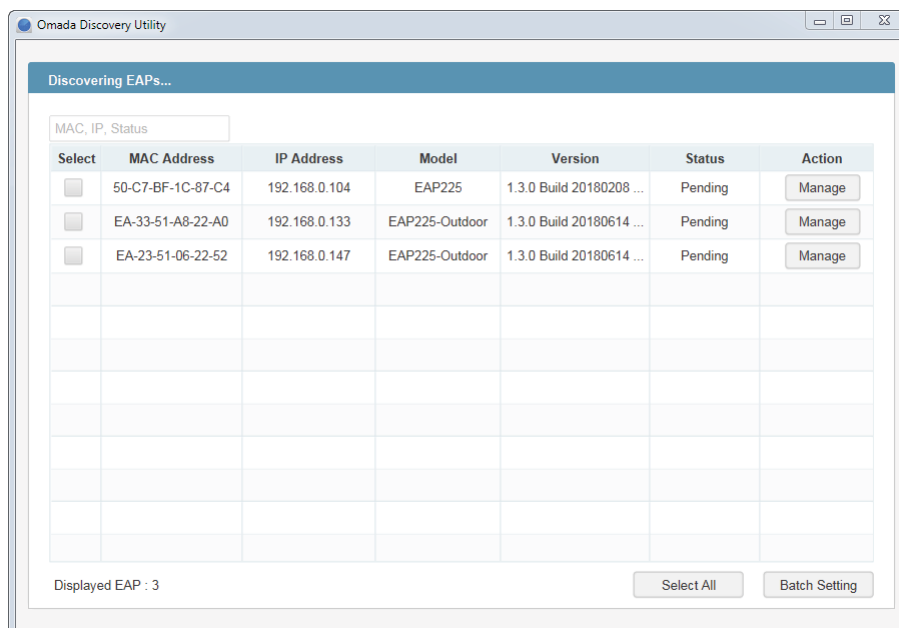

4. Click **Manage** in the **Action** column or select multiple EAPs and click **Batch Setting**.
5. Enter the hostname or IP address of the Controller Host.
6. Enter the EAP's username and password (both are admin by default).



The image shows a 'Device Information' dialog box with the following fields and values:

Status:	Pending
Model:	EAP225
IP Address:	192.168.0.104
MAC Address:	50-C7-BF-1C-87-C4
Controller Hostname/IP:	<input type="text" value="192.168.1.100"/>
Username:	<input type="text" value="admin"/>
Password:	<input type="password" value="••••"/>

At the bottom of the dialog are two buttons: 'Apply' and 'Cancel'.

7. Click **Apply** to inform the EAP of the Controller Host's hostname or IP address. And then the connection can be established between the EAP and the Controller Host.

1.4 Start and Log In to the Omada Controller

Launch Omada Controller and follow the instructions to complete the basic configurations, and then you can log in to the management interface.

1.4.1 Launch Omada Controller

Double click the icon  and the following window will pop up. You can click **Hide** to hide this window but do not close it. After a while, your web browser will automatically open.



Note:

- If your browser does not open automatically, click **Launch a Browser to Manage Wireless Network**. You can also launch a web browser and enter `http://127.0.0.1:8088` in the address bar.
- If your web browser opens but prompts a problem with the website's security certificate, click **Continue**.
- Only one Omada Controller can run in a LAN. If an Omada Controller has already been running on a host that is in your LAN, you will be redirected to the Omada Controller interface on that host.

1.4.2 Do the Basic Configurations

In the web browser you can see the configuration page. Follow the setup wizard to complete the basic settings for Omada Controller.

1. Click **Let's Get Started**.

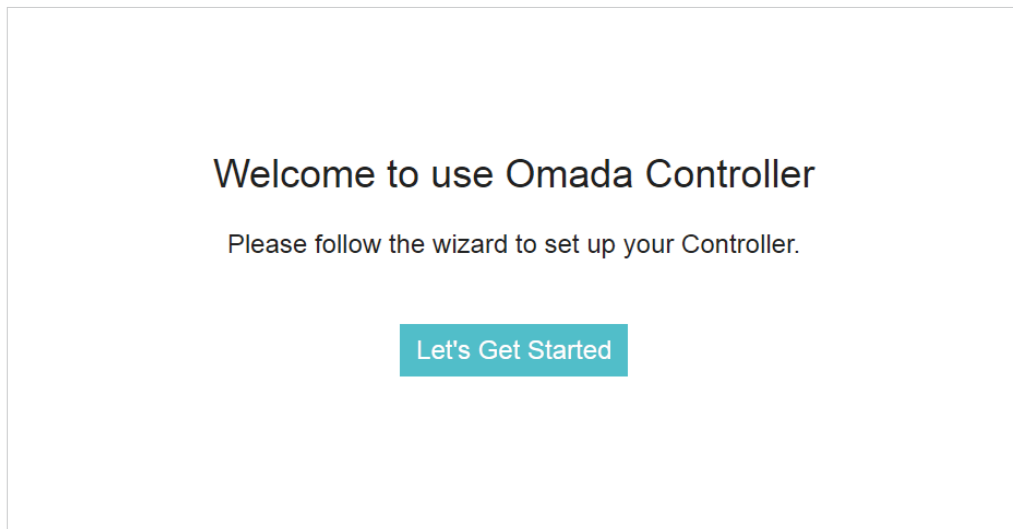

2. Specify a name for Omada Controller. Click **Next**.

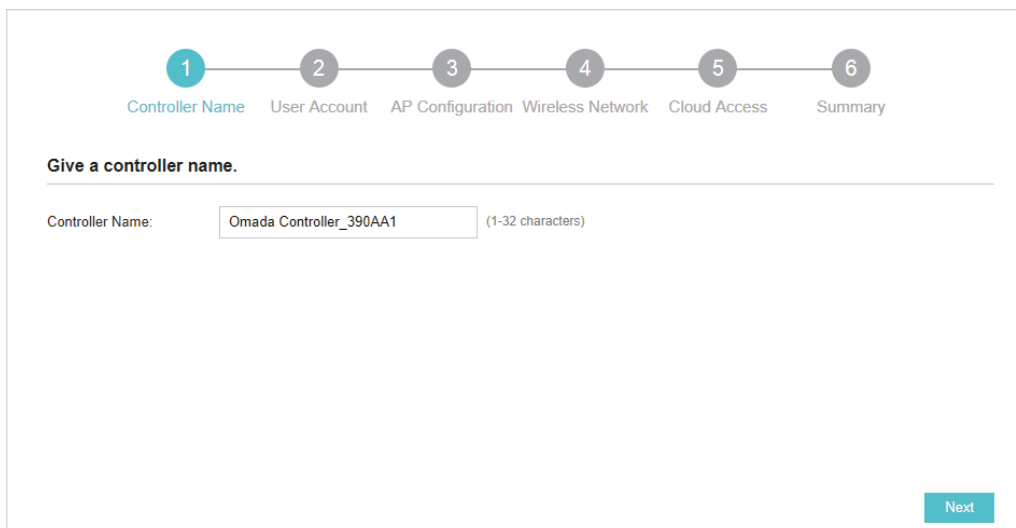

3. Specify a username and password for the login account. Specify the email address for resetting your password in case that you forget the password. After logging in Omada Controller, set a mail server so that you can receive emails and reset your password. For how to set a mail server, refer to [Configure Mail Server](#). Click **Next**.

1 Controller Name 2 User Account 3 AP Configuration 4 Wireless Network 5 Cloud Access 6 Summary

Set up a Username and Password for local login.

Username: (4-32 characters)

Password: (6-32 characters, only numbers and letters.)

Confirm Password:

Email Address: (Optional. Enter your email address to receive mails for resetting your password. The mails are sent from the mail server you set after logging into the Omada Controller.)

[Back](#) [Next](#)

4. The setup page displays all the detected EAPs in the network. Select one or more EAPs to be managed and click **Next**.

1 Controller Name 2 User Account 3 AP Configuration 4 Wireless Network 5 Cloud Access 6 Summary

Please select the devices you would like to configure

<input checked="" type="checkbox"/>	↕ AP Name	↕ IP Address	↕ Model	↕ Hardware Version
<input checked="" type="checkbox"/>	50-C7-BF-0B-BE-00	192.168.0.164	EAP225(US)	1.0/2.0

<< < 1 > >> A total of 1 page(s) Page to: [GO](#)

[Back](#) [Skip](#) [Next](#)

5. Set an SSID name (wireless network name) and password for the EAPs to be managed. Omada Controller will create two wireless networks, a 2.4GHz one and a 5GHz one, both encrypted in WPA2-PSK mode. Click **Next**.

1 Controller Name 2 User Account 3 AP Configuration 4 **Wireless Network** 5 Cloud Access 6 Summary

Create a wireless network

Network Name: (1-32 characters)

Password: (WPA2-PSK)

6. If you want to manage EAPs via Omada Cloud, enable the **Cloud Access** button, and bind your TP-Link ID to your Omada Controller, and then click **Next**. If you want to manage EAPs on the local network, you can just click **Skip**. For more details about Omada Cloud, please refer to [Omada Cloud Service](#) in chapter 4.

1 Controller Name 2 User Account 3 AP Configuration 4 Wireless Network 5 **Cloud Access** 6 Summary

Log in and bind your TP-Link ID

Cloud Access: ?

Email:

Password:

No TP-Link ID? [Register now.](#)

7. Review your settings and click **Finish**.

1 — 2 — 3 — 4 — 5 — 6
 Controller Name User Account AP Configuration Wireless Network Cloud Access Summary

Confirm the settings.

User Account	Wireless Network	Cloud Access
Username: administrator	Network Name: SSID1	Cloud Access: off
Password: 123456	Password: 12345678	TP-Link ID: Not Logged In

Back Finish

1.4.3 Log In to the Management Interface

Once the basic configurations are finished, the browser will be redirected to the following page. Log in to the management interface using the username and password you have set in the basic configurations.

Note:

In addition to the Controller Host, other hosts in the same LAN can also manage EAPs via remote access to the Controller Host. For example, if the IP address of the Controller Host is 192.168.0.100 and Omada Controller is running normally on this host, you can enter <https://192.168.0.100:8043/login>, or <https://192.168.0.100:8043>, or <http://192.168.0.100:8088> in the web browser of other hosts in the same LAN to log in to the Omada Controller and manage EAPs. Or you can log in to Omada Controller on the management devices through Omada Cloud service.

1.5 Create Sites and Adopt EAPs

Omada Controller can manage multiple EAP networks, which are called sites. Multiple sites are logically separated, and each site has its own configurations. There is an initial site named **Default**. The **Default** site cannot be deleted. If you have no need to manage EAPs with different sites, you can edit the default site and skip the **Create Sites** section. However, **Adopt the EAPs** is a necessary step to manage the EAPs.

1.5.1 Create Sites

There are three methods to create sites: [Add sites](#), [Import sites](#), and [Copy sites](#). Determine the method according to your need and refer to the following introductions to create sites.

Add Sites

Follow the steps below to add a new site directly.

1. Click **Sites: Default** in the top left corner of the page and select **Site Manager**, and then the following window will pop up.

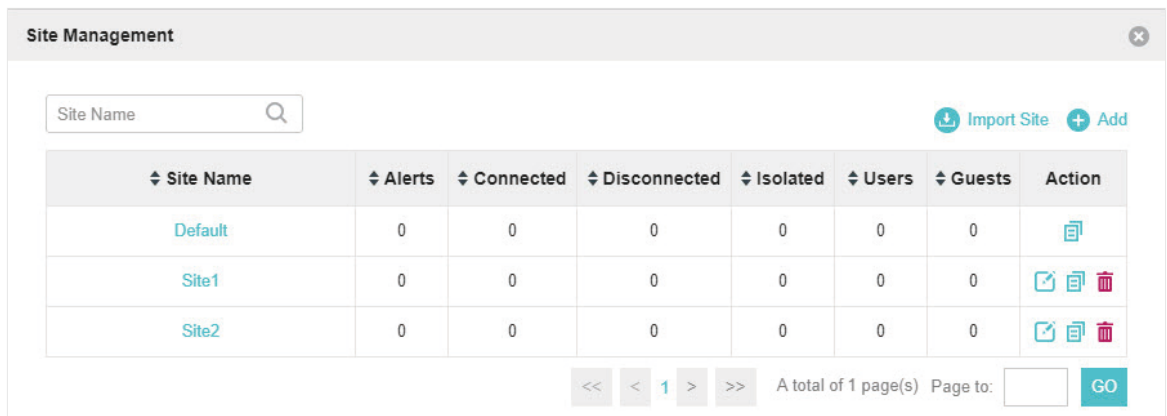

The screenshot shows a 'Site Management' window with a search bar for 'Site Name' and buttons for 'Import Site' and '+ Add'. Below is a table with columns for Site Name, Alerts, Connected, Disconnected, Isolated, Users, Guests, and Action. The table lists three sites: Default, Site1, and Site2, all with 0 alerts, connected, disconnected, and isolated counts, and 0 users and guests. The Action column contains icons for edit, copy, and delete. At the bottom, there are pagination controls showing '1' of 1 page(s) and a 'GO' button.

↕ Site Name	↕ Alerts	↕ Connected	↕ Disconnected	↕ Isolated	↕ Users	↕ Guests	Action
Default	0	0	0	0	0	0	
Site1	0	0	0	0	0	0	
Site2	0	0	0	0	0	0	

2. Click **+ Add** and enter a unique name for the new site.

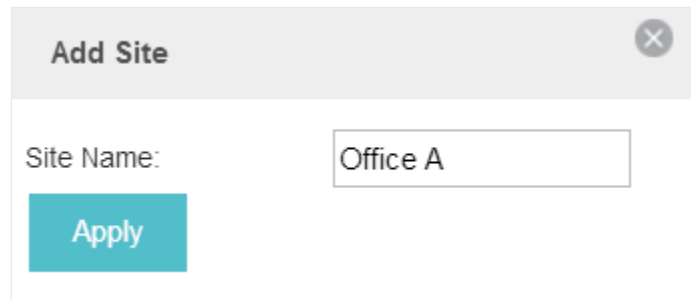

The screenshot shows an 'Add Site' dialog box with a close button in the top right. The 'Site Name:' label is followed by a text input field containing 'Office A'. Below the input field is a teal 'Apply' button.

3. Click **Apply** to create the site.

Import sites

You can import the site from another controller. The site settings and EAPs in the site will be imported to the new site. Note that the site to be imported must come from a different controller.

1. Click **Sites: Default** in the top left corner of the page and select **Site Manager**, and then the following window will pop up.

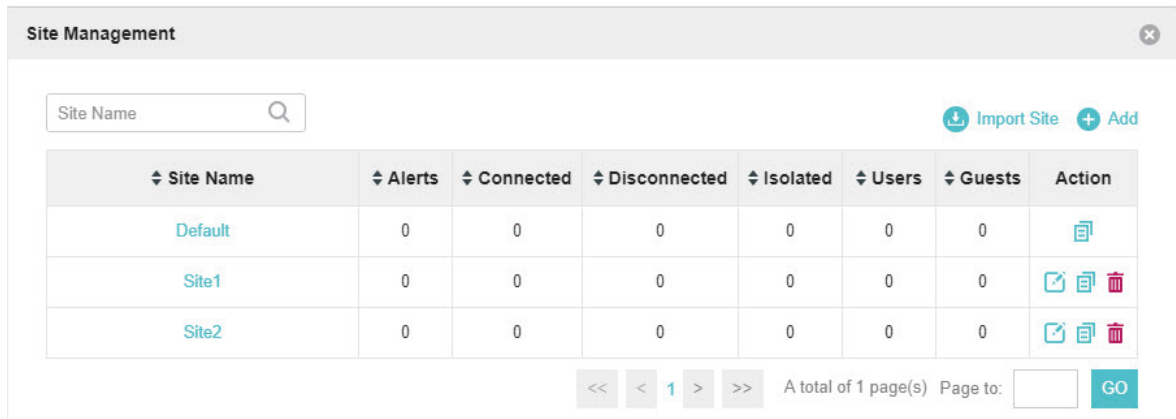

The screenshot shows the 'Site Management' window. At the top, there is a search bar for 'Site Name' and two buttons: 'Import Site' (with a download icon) and 'Add' (with a plus icon). Below this is a table with the following columns: Site Name, Alerts, Connected, Disconnected, Isolated, Users, Guests, and Action. The table contains three rows: 'Default', 'Site1', and 'Site2'. Each row shows 0 for Alerts, Connected, Disconnected, Isolated, Users, and Guests. The Action column for 'Default' has a copy icon, while 'Site1' and 'Site2' have copy, refresh, and delete icons. At the bottom of the table, there are pagination controls: '<<', '<', '1', '>', '>>', and a text 'A total of 1 page(s) Page to: [input] GO'.

↕ Site Name	↕ Alerts	↕ Connected	↕ Disconnected	↕ Isolated	↕ Users	↕ Guests	Action
Default	0	0	0	0	0	0	
Site1	0	0	0	0	0	0	
Site2	0	0	0	0	0	0	

2. Click **Import Site** and enter a unique name for the new site.

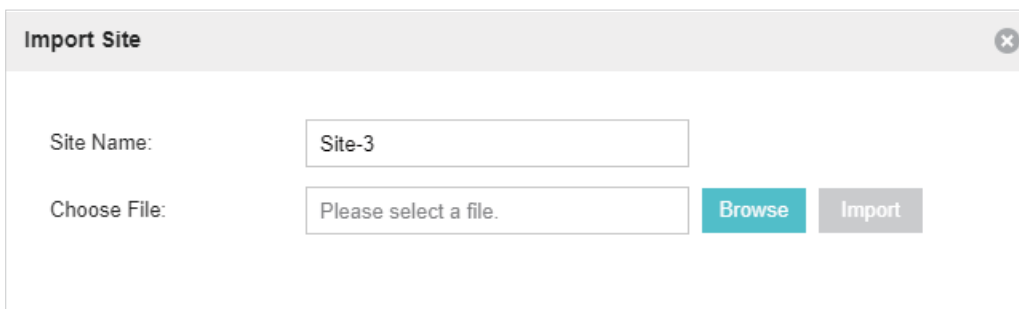

The screenshot shows the 'Import Site' dialog box. It has a title bar with 'Import Site' and a close button. Inside, there is a 'Site Name:' label followed by a text input field containing 'Site-3'. Below that is a 'Choose File:' label followed by a text input field containing 'Please select a file.' To the right of the file input field are two buttons: 'Browse' (teal) and 'Import' (grey).

3. Click **Browse** to upload the backup file of other site and click **Import** to import the site.

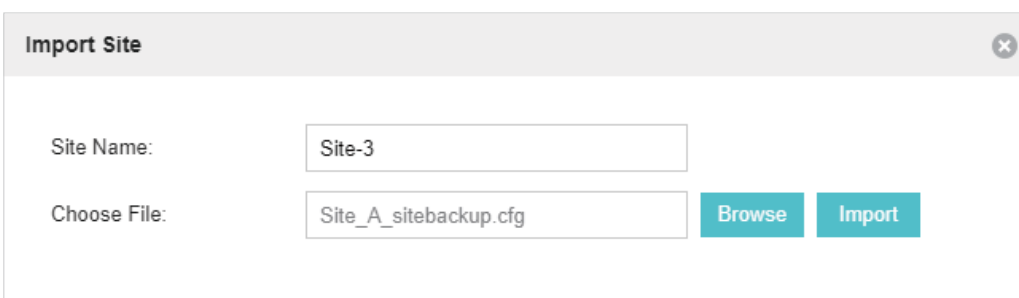

The screenshot shows the 'Import Site' dialog box after a file has been selected. The 'Site Name:' field still contains 'Site-3'. The 'Choose File:' field now contains 'Site_A_sitebackup.cfg'. The 'Browse' button is teal, and the 'Import' button is also teal.

Tips:

To export sites (including site settings and EAPs in the sites) from one controller to another, use the **Migrate** function. For more details about **Migrate**, refer to [Migrate](#).

Copy Sites

With **Site Copy**, you can create a new site with the same settings as the existing sites on your controller. Note that only the site settings will be copied. The EAPs will be still managed at the original site.

1. Click **Sites: Default** in the top left corner of the page and select **Site Manager**, and then the following window will pop up.

The screenshot shows a 'Site Management' window with a search bar for 'Site Name' and buttons for 'Import Site' and 'Add'. Below is a table with columns for Site Name, Alerts, Connected, Disconnected, Isolated, Users, Guests, and Action. The table lists three sites: Default, Site1, and Site2, all with 0 alerts, connected, disconnected, and isolated counts, and 0 users and guests. The Action column contains icons for copy, edit, and delete.

↕ Site Name	↕ Alerts	↕ Connected	↕ Disconnected	↕ Isolated	↕ Users	↕ Guests	Action
Default	0	0	0	0	0	0	
Site1	0	0	0	0	0	0	
Site2	0	0	0	0	0	0	

At the bottom of the table, there are pagination controls: '<<' '<' '1' '>' '>>' and the text 'A total of 1 page(s) Page to: GO'.

2. Select a site that you want copy all the settings and click in the **Action** column. Then enter a unique name for the new site.

The screenshot shows a 'Site Copy' dialog box with a close button. It contains a note: 'Note: With Site Copy, you can create a new site with the same configuration as the existing site.' Below the note is a label 'New Site Name:' followed by an empty text input field. At the bottom left is a teal 'Apply' button.

3. Click **Apply** to create the site.

1.5.2 Adopt the EAPs

Omada Controller can discover all EAPs currently connected in the network and display their connection status. All EAPs are in **Pending** status when first discovered by Omada Controller. To manage the EAPs, you need to adopt them. In the quick setup process, Omada Controller will automatically adopt the selected EAPs using the default username and password (both are admin). However, if you have changed the username or password of your EAPs before, Omada Controller cannot automatically adopt them, and you need to refer to the following steps to adopt them manually.

To ensure that all EAPs are adopted, follow the steps below:

1. Select a site and go to **Access Points > Pending**. The table displays all the EAPs that have not been adopted.

AP Name	MAC Address	IP Address	Status	Model	Hardware Version	Firmware Version	Channel	Client Number	Download	Upload	Action
EA-23-51-06-22-52	EA-23-51-06-22-52	192.168.0.220	Pending	EAP225-Outdoor(EU)	1.0	1.5.0 Build 20181129 Rel. 69517	--	0	0 Bytes	0 Bytes	Retry

2. Click the **Retry** button in the **Action** column and enter the current username and password of the EAP. Click **Apply**.

AP username and password required

Note: The username and password have been changed for this AP. The Omada Controller cannot adopt it automatically. Please manually enter the correct username and password.

Username:

Password:

Apply

Tips:

- If you have a new discovered EAP, you can click the **Adopt** in the **Action** column to adopt the EAP. Omada Controller will automatically adopt the EAP using the default username and password (both are admin).
- If you have multiple new discovered EAPs, and all of them have the default username and password (both are admin), you can click the **Batch Adopt** button to adopt them in batch. But if there are any EAPs with the **Retry** button, it means that the username and password of these EAPs have been changed. You need to first adopt them before batch adopt the rest EAPs.

3. After EAPs are adopted, the status will change from **Pending** to **Connected**. All the EAPs' username and password will become the same as those of the Controller's administrator account you created in the [Basic Configuration](#).

Tips:

If you want to change the EAPs' username and password, refer to [Device Account](#).

1.6 Monitor and Manage the EAPs

When all the configurations above are finished, you can centrally monitor and manage the EAPs via the Omada Controller's management interface. The management interface is divided into three sections as the following figure shows.

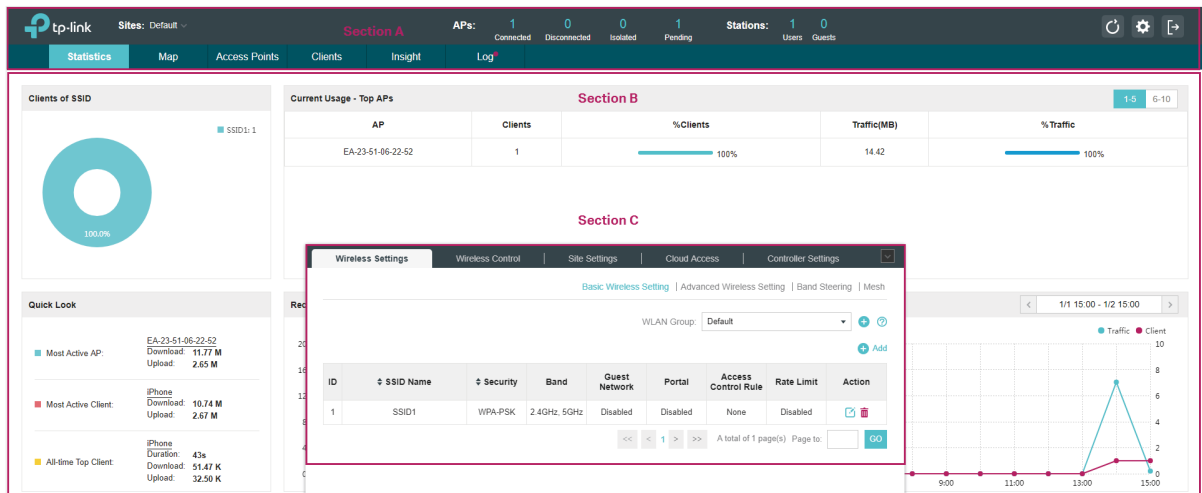

Section A

In Section A, you can check the status of EAPs and clients in the network. Also, you can click to refresh the current page, click to globally configure the wireless network, and click to sign out from the management interface.

Furthermore, the **Sites** allows you to group your EAPs and manage them in batches. To configure sites, refer to [Create Sites](#).

Section B

In Section B, you can centrally monitor the EAPs and clients.

Section C

In Section C, you can globally configure the wireless network. The global configurations will take effect on all the adopted EAPs.

2

Monitor and Manage the Network

With Omada Controller you can monitor the EAPs and centrally manage your wireless network. This chapter includes the following sections:

- View the Statistics of the Network
- Monitor the Network with the Map
- Monitor and Manage the EAPs
- Monitor and Manage Clients
- View Clients Statistics during the Specified Period
- Manage the Rogue APs List
- View Past Guest Authorization
- View Logs

2.1 View the Statistics of the Network

Omada Controller collects all statistics of the managed EAPs and displays the statistical information via graphs, pie charts and tables, providing an overview of your wireless network.

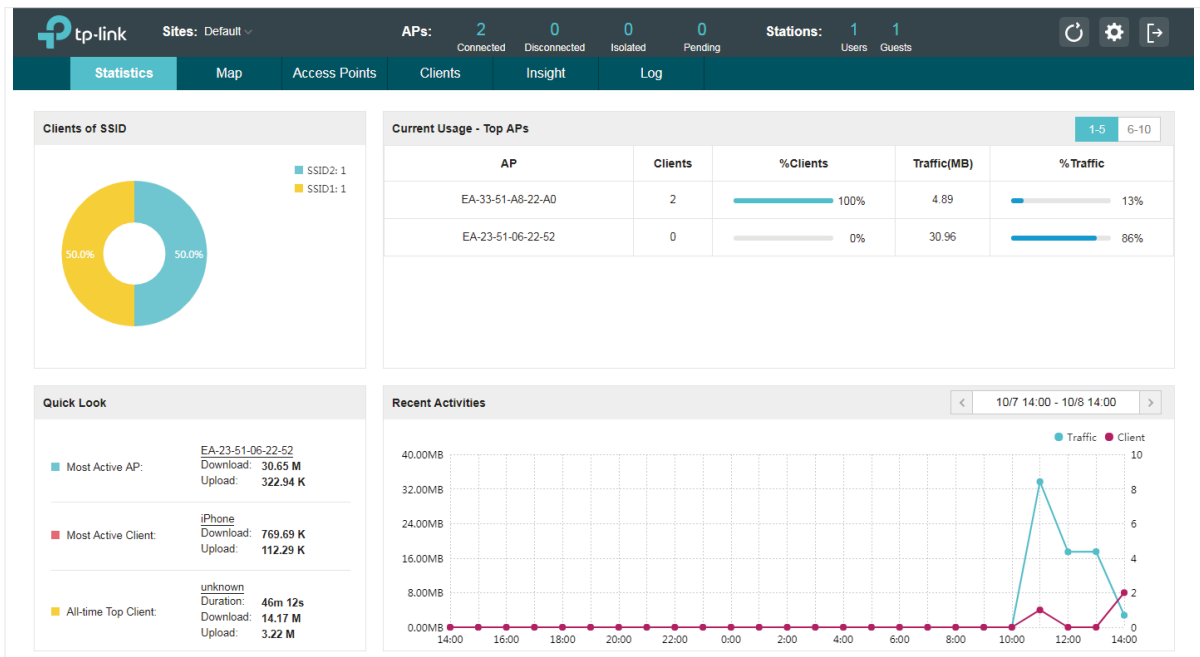

2.1.1 View the Client Distribution on SSID

A visual pie chart shows the client distribution on each SSID. For example, the SSID1 has one client, which occupies 50% of all the clients.

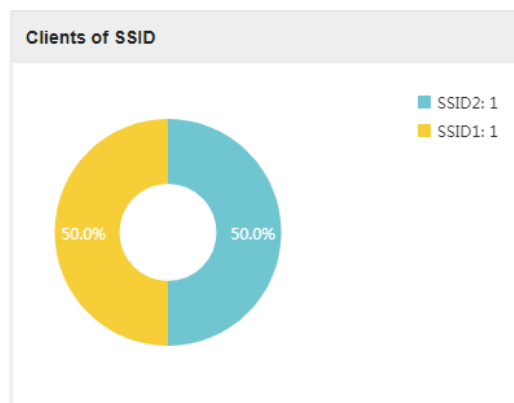

2.1.2 Have a Quick Look at EAPs and Clients





This tab displays the **Most Active AP**, the **Most Active Clients** and the **All-Time Top Client**. You can click the MAC address of the EAP or the client to see more details.

Quick Look	
■ Most Active AP:	EA-23-51-06-22-52 Download: 30.65 M Upload: 322.94 K
■ Most Active Client:	iPhone Download: 769.69 K Upload: 112.29 K
■ All-time Top Client:	unknown Duration: 46m 12s Download: 14.17 M Upload: 3.22 M

Most Active AP	The current connected AP with the maximum traffic.
Most Active Client	The current connected client with the maximum traffic.
All-time Top Client	The client with the maximum traffic among all the clients that have ever accessed the EAP network.

2.1.3 View Current Usage-Top EAPs

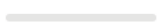
This tab lists the number of connected clients and the data traffic condition of the ten APs that use the most traffic currently.

Current Usage - Top APs				
AP	Clients	%Clients	Traffic(MB)	%Traffic
EA-33-51-A8-22-A0	2	 100%	4.89	 13%
EA-23-51-06-22-52	0	 0%	30.96	 86%

Clients	The amount of clients connected to this EAP.
%Clients	The proportion of current connected clients to the Top EAPs' total client amount.
Traffic (MB)	The total amount of data transmitted by this EAP, which equals the sum of the transmission traffic of all the current clients that connect to the AP.
%Traffic	The proportion of the EAP's current data transmission amount to the Top EAPs' total transmission amount.

2.1.4 View Recent Activities

The **Recent Activities** statistics can be toggled between a view for the past specific 24 hours and one for the past specific 30 days.

The left ordinate axis indicates the traffic and the right one represents the number of the clients. The abscissa axis shows the selected time period. **Traffic** indicates a visual graph of the network

traffic during the selected time period. **Client** indicates a visual graph of the number of the connected clients during the selected time period. For example, the statistics information at 15:00 indicates the traffic size and client number from 14:00 to 15:00. In the following figure, at 11 o'clock, the traffic is about 34MB and there is 1 clients connected to the AP.

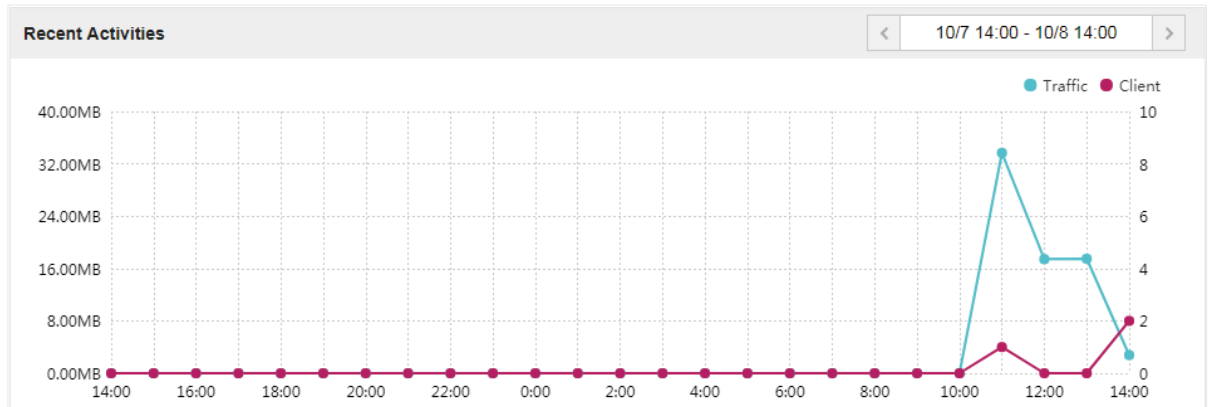

2.2 Monitor the Network with the Map

You can upload your local map images and monitor the status and coverage range of each EAP with the map. When you initially launch Omada Controller, a default map is displayed as the following figure shows. Follow the instructions below to add your own map and manage the EAPs via the map.

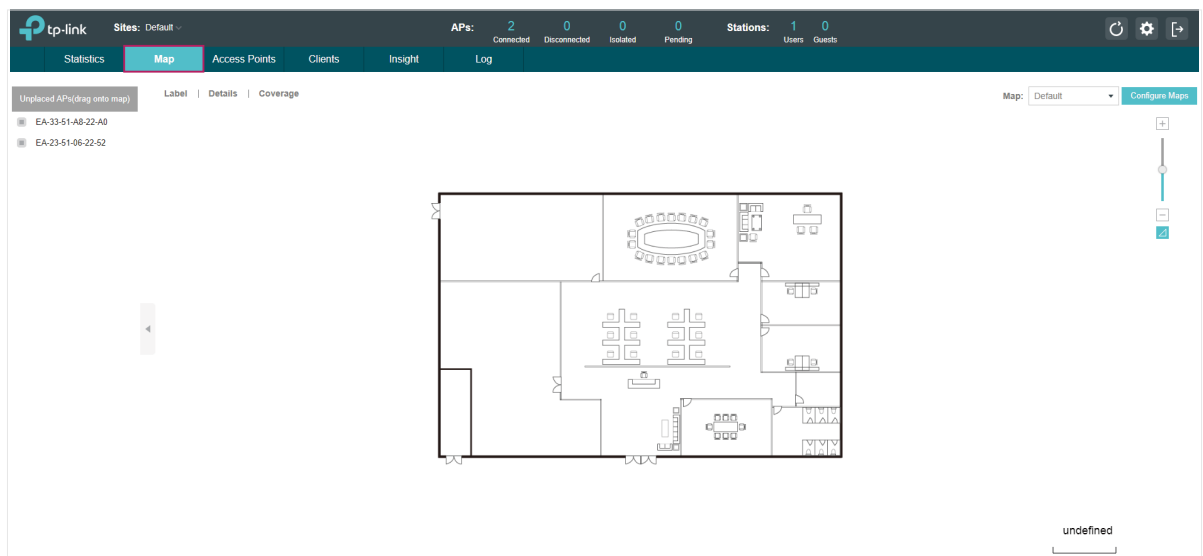

2.2.1 Add a Map

Prepare a map image in .jpg, .jpeg, .gif, .png, .bmp, .tiff format. And then follow the steps below to add the map to the Omada Controller.

1. Click **Configure Maps** on the upper right corner of the Map page and click **Add**.

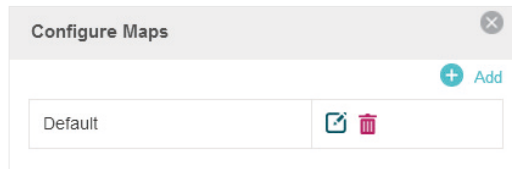

2. Enter the map description, select your map image, and click **Create**.

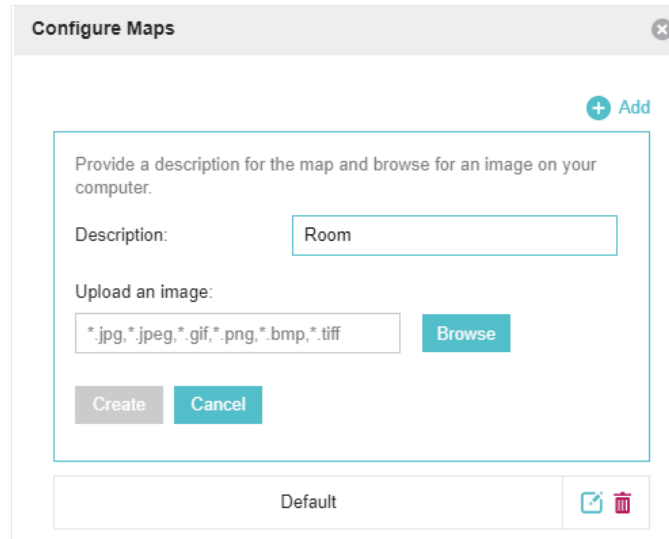

3. Select your local map from the drop-down list on the upper right corner of the map area.

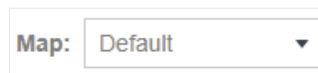

4. Click . Draw a line on the map and enter the distance the line represents. Then the Omada Controller will compute and generate the map scale automatically based on your configuration.

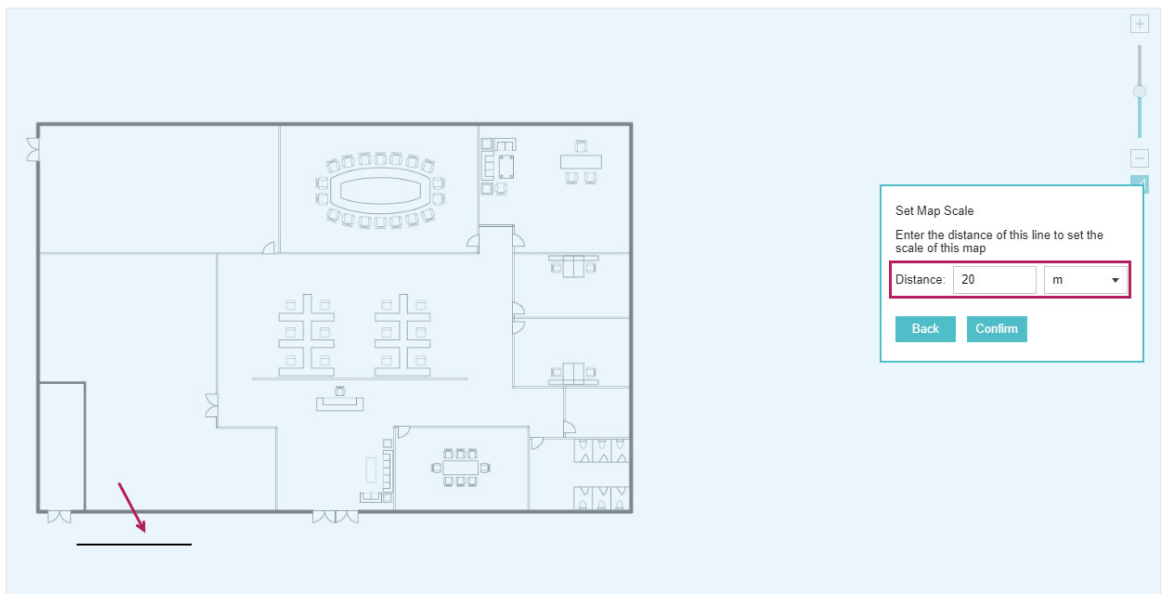



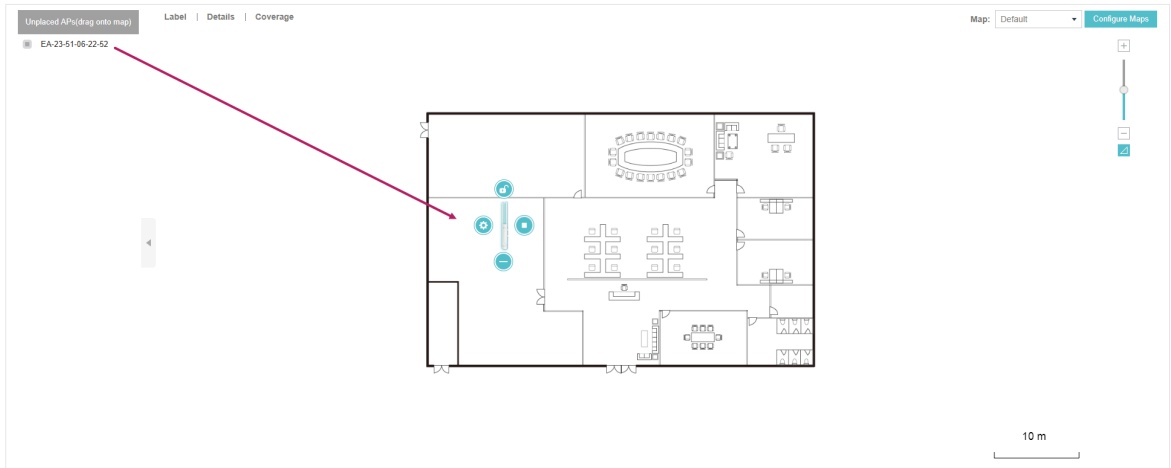



5. Drag the EAPs from the **Unplaced APs** list to the appropriate locations on the map according to their actual locations.



You can click  to reveal additional options:



- 
 Lock the selected EAP in the current location on the map.
- 
 Unlock the selected EAP and you can drag it to another location.
- 
 Display the EAP's details and configure the wireless parameters. Refer to [Configure the EAPs Separately](#).
- 
 Remove the selected EAP back into the Unplaced APs list.
- 
 Flash the LED of the EAP on the map. Then the LED will flash for 10 minutes or until the cancel button is clicked again.
- 
 Click the button to stop the LED from flashing.

2.2.2 Monitor the EAPs on the Map

Click any of the following options to display EAP Label, Details, and Coverage on the map.

Label | **Details** | **Coverage**

Label	Display the EAP's name. The default name is the MAC address of the EAP.
Details	Display the EAP's name, MAC address, IP address, transmitting/receiving channel, number of connected users, and number of connected guests.
Coverage	Display a visual representation of the wireless range covered by EAPs. The actual signal coverage may be smaller than the visual coverage on the map because the obstacles around the EAPs will weaken the signal.

2.3 Monitor and Manage the EAPs

Omada Controller can discover all the EAPs currently connected to the network and display the information of them on the **Access Points** page.

AP Name	MAC Address	IP Address	Status	Model	Hardware Version	Firmware Version	Channel	Client Number	Download	Upload	Action
EA-33-51-A8-22-A0	EA-33-51-A8-22-A0	192.168.0.103	Connected	EAP225-Outdoor(EU)	1.0	1.3.0 Build 20180614 Rel. 50359	11(2.4G), 48(5G)	0	22.50 M	258.15 K	Refresh Settings Forget
EA-23-51-06-22-52	EA-23-51-06-22-52	192.168.0.100	Connected	EAP225-Outdoor(EU)	1.0	1.3.0 Build 20180614 Rel. 50359	11(2.4G), 48(5G)	1	62.07 M	1.65 M	Refresh Settings Forget

2.3.1 Manage the EAPs in Different Status

According to their connection status, EAPs are divided into four categories: **Connected**, **Disconnected**, **Isolated** and **Pending**. You can view the EAPs in different status on different pages:

[All](#) | [Connected](#) | [Disconnected](#) | [Isolated](#) | [Pending](#)

All	Displays the information of all EAPs in different status.
Connected	<p>Displays the connected EAPs.</p> <p>The status of connected EAPs includes two cases: Connected and Connected (Wireless).</p> <p>Connected: After you adopt a wired EAP in Pending status, its status will become Provisioning, then Configuring and Connected eventually.</p> <p>Connected (Wireless): In a mesh network, if an EAP has a successful wireless uplink, its status will become Adopting (Wireless) and then Connected (Wireless).</p> <p>Only connected EAPs can be managed. A connected EAP will turn into a pending one after you forget it. You can refer to Forget this AP to forget an EAP or click Forget All on the page to forget all the connected EAPs.</p>
Disconnected	<p>Displays the disconnected EAPs.</p> <p>If a connected EAP powers off or disconnects from the Omada Controller, it will be in Disconnected status. When a disconnected EAP is reset to factory defaults or forgot, it will turn into a pending one again. You can refer to Forget this AP to forget a EAP or click Forget All on the page to forget all the disconnected EAPs.</p>
Isolated	<p>Displays the isolated EAPs.</p> <p>In a mesh network, when the EAP which has been managed before by Omada Controller connects to the network wirelessly and cannot reach the gateway, it goes into the Isolated state. The isolated EAP searches for wireless uplink and the LED on the device turns green and flashes off every 5 seconds. To know more about mesh network, refer to Configure Mesh.</p>

Pending	<p>Displays the pending EAPs.</p> <p>The status of pending EAPs includes three cases: Pending, Pending (Wireless) and Managed by others.</p> <p>Pending: All the EAPs with wired network connection are in pending status by default when first discovered by Omada Controller.</p> <p>Pending (Wireless): The factory default EAP with mesh functions and no wired network connection is in Pending (Wireless) status when first discovered by Omada Controller.</p> <p>Managed by others: An EAP is located on the same network as the controller, but has been already managed by an existing controller before. You can provide the username/password to unbind the EAP from the existing controller and begin adoption in current controller.</p> <p>Only after pending EAPs are adopted and connected, you can manage them. To adopt pending EAPs, refer to Adopt the EAPs.</p>
---------	---

2.3.2 View the Detailed Information of EAPs

You can click **Overview**, **Config**, **Performance** or **Mesh Network** tab to view different detailed information of EAPs.

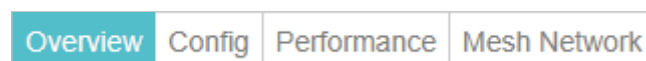



Overview	Displays the EAP's name, MAC address, IP address, status, model, hardware version, firmware version, channel number of connected clients and download/upload bytes.
Config	Displays the EAP's name, MAC address, IP address, status, model, hardware version, firmware version, WLAN Group bounded with the 2G and 5G of the EAP, and radio of the 2G and 5G.
Performance	Displays the EAP's name, MAC address, IP address, status, model, hardware version, firmware version, number of connected 2G clients and 5G clients, TX(Downloaded Traffic), RX(Uploaded Traffic), TX 2G and TX 5G.
Mesh Network	Displays the EAP's name, MAC address, IP address, status, model, hardware version, firmware version, number of connected clients, hops, uplink APs and downlink APs.

2.3.3 Manage the EAPs in the Action Column

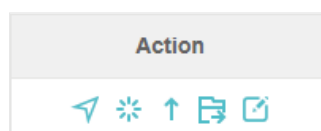
You can execute the corresponding operation to the EAP by clicking an icon in the **Action** column.



	Locate the EAP in the map.
	Reboot the EAP.



Upgrade the EAP.

Two options are available for upgrading: upgrade online and upgrade manually.

Upgrade online: With Cloud Access enabled on the controller and a TP-Link ID bound with the controller, the latest firmware for the EAP can be detected by the controller automatically. And you can upgrade the EAP online by clicking **Upgrade Now**. For more details about Cloud Access, refer to [Omada Cloud Service](#).

Upgrade manually: Click **Browse** to locate and choose the upgrade file in your computer, then click **Upgrade** to install the latest EAP firmware. The Status will appear as **Upgrading** until the process is complete and the EAP reconnects to the Omada Controller.

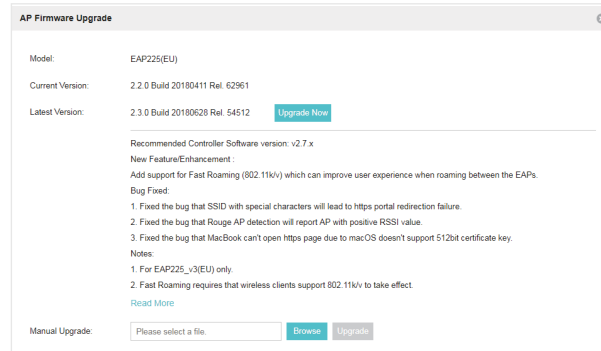

Move the EAP to a site.

Select a site that has been created and click **Apply**. You can group all the EAPs by this way and centrally manage them on each site.

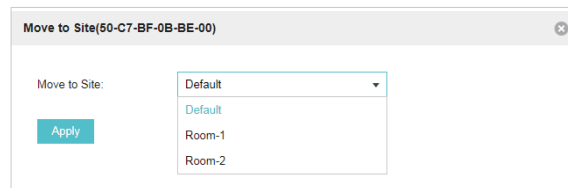

Configure the EAP.

For detailed instructions about how to configure the EAP on this window, refer to [Configure the EAPs Separately](#).

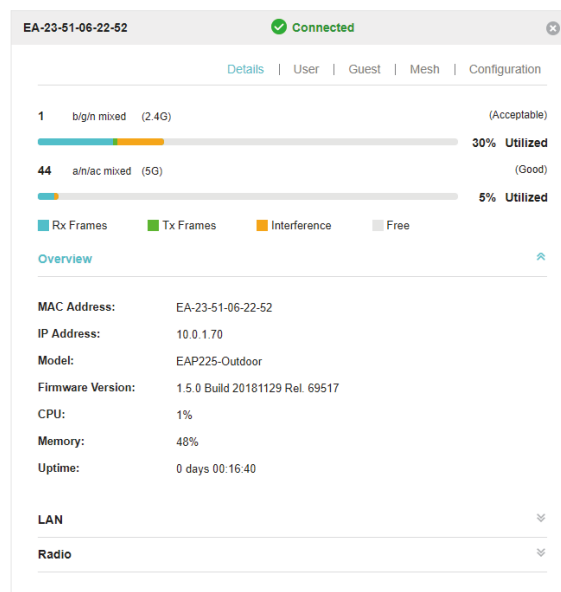

Note:

- Only managed EAPs can be rebooted or upgraded.
- The EAP which is managed by the controller can not be logged in to its own management interface. To log in to the EAP's own management interface, forget the EAP in the controller first.

2.4 Monitor and Manage Clients

The **Clients** tab displays the clients connected to the EAP network.

Hostname	MAC Address	IP Address	Access Point	SSID	User / Guest	2.4GHz / 5GHz	Download	Upload	Rate (Mbps)	Active Time	Signal	Action
iPhone	D0-A6-37-83-DA-99	192.168.0.104	EA-23-51-05-22-52	1122	User	2.4GHz	19.74 K	46.76 K	65.0	14m 45s		

2.4.1 View the Current Information of Clients

The clients are divided into two types: User and Guest. Users are the clients connected to the EAP wireless network without the [Portal Authentication](#). Guests are the clients connected to the EAP wireless network with the [Portal Authentication](#).

You can click the following tabs to respectively view the detailed information of users and guests.

[All Clients](#) | [Users](#) | [Guests](#)

All Clients	The page displays the information of all clients including users and guests.
Users	The page displays the information of Users.
Guests	The page displays the information of Guests.

2.4.2 Manage Clients in the Action Column

You can execute the corresponding operation to the EAP by clicking an icon in the **Action** column:

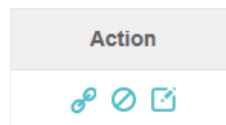

	Reconnect the client to the network.
	Restrict the client's access to the network.



Configure the rate limit of the client and view the connection history.
Enter the download limit and upload limit and click **Apply**.

iPhone (D0-A6-37-83-DA-99)

[Rate Limit](#) | [Connection History](#)

Note: You can limit the download and upload rate of the client to balance bandwidth usage. The download and upload rate will be limited to the minimum of the value configured in SSID, client and portal configuration.

Download Limit: Kbps (0-10240000. 0 means no limit.)

Upload Limit: Kbps (0-10240000. 0 means no limit.)

Apply



If the client is a Guest, you can click this icon to cancel the authorization for it.

2.5 View Clients Statistics During the Specified Period

The **Clients Statistics** page under the **Insight** tab displays the information of clients that have connected to the EAPs network during a specified period.

Hostname	MAC Address	Download	Upload	Duration	Last Seen	Action
iPhone	D0-A6-37-83-DA-99	872.76 K	240.61 K	29m 12s	2018-10-08 15:32:58	
unknown	A4-44-D1-DE-7B-AB	27.92 M	4.81 M	1h 5m 47s	2018-10-08 16:40:27	

2.5.1 Select a Specified Period

Select a period from the drop-down menu. Then the page will display clients that have connected to the EAPs network during the period.

Last Seen: All

Last Seen: All

Last Seen: 1 Day

Last Seen: 3 Days

Last Seen: 7 Days

Last Seen: 14 Days

Last Seen: 30 Days

2.5.2 View the History Information of Clients

You can click the client's MAC address to get its connection history and configure the Rate Limit feature for this client. In addition, you can click the following tabs to view the information of different types of clients:







All	The page displays the history information of all the clients.
User	The page displays the history information of Users. Users are the clients connected to the EAP wireless network without the Portal Authentication .
Guest	The page displays the history information of Guests. Guests are the clients connected to the EAP wireless network with the Portal Authentication .
Blocked	The page displays the clients that have been blocked.
Rate Limited	The page displays the clients that have been limited upload or download rate.



All	The page displays the history information of all clients.
Offline Only	The page displays the history information of the off-line clients.

2.5.3 Manage Clients in the Action Column

You can execute the corresponding operation to the EAP in the **Action** column:

	Block the client's access to the network.
	Resume the client's access.
	Configure the rate limit of the client and view the connection history.
	Remove the limit to the client's upload or download rates.

2.6 Manage the Rogue APs List

A Rogue AP is an access point that has been installed on a secure network without explicit authorization from a system administrator. The Omada Controller can scan all channels to detect

all nearby EAPs. If rogue APs are detected, they will be shown on the **Untrusted Rogue APs** list. Besides, you can move the untrusted rogue APs to the **Trusted Rogue APs** list.

By default, the Rogue AP Detection feature is disabled. To allow your EAP to detect nearby APs, you need to enable this feature for this EAP. You can refer to [Rogue AP Detection](#).

2.6.1 Manage the Untrusted Rogue APs List

The **Untrusted Rogue APs** page displays the detailed information of untrusted rogue APs.

MAC	SSID	Band	Channel	Security	Beacon	Signal	Last Seen	Action
F4-83-CD-D3-8C-32	rubin	2.4G	1	ON	100	-91	2018-10-08 17:06:14	
50-C7-BF-48-57-1E		2.4G	2	ON	100	-90	2018-10-08 17:06:14	
50-C7-BF-3F-19-F0		5G	36	ON	100	-86	2018-10-08 17:06:14	
98-9C-87-DE-1E-78	Neusoft	2.4G	1	ON	100	-88	2018-10-08 17:06:14	
06-69-6C-56-94-64	NanS	2.4G	1	ON	100	-85	2018-10-08 17:06:14	
C4-71-54-F7-33-8A	Louis_c9_5	5G	36	ON	100	-71	2018-10-08 17:06:14	
50-C7-BF-1C-87-C5	SSID_1	5G	36	ON	100	-52	2018-10-08 17:06:14	
70-4F-57-BF-31-9A	TP-Link_730E	2.4G	1	ON	100	-76	2018-10-08 17:06:14	
C0-4A-00-0A-AA-F7	TP-LINK_AAF7_5G	5G	36	ON	100	-72	2018-10-08 17:06:14	
50-C7-BF-B3-F8-4B	RE365-5G	5G	36	ON	100	-72	2018-10-08 17:06:14	

You can execute the corresponding operation to the EAP in the **Action** column:

- Move the untrusted rogue AP to the Trusted Rogue APs list.
- Delete this record.
- Delete All** Delete all records.

2.6.2 Manage the Trusted Rogue APs List

The **Trusted Rogue APs** page displays the detailed information of trusted rogue APs.

MAC	SSID	Band	Channel	Security	Last Seen	Action
70-4F-57-BF-31-9A	TP-Link_730E	2.4G	1	ON	2018-10-08 17:08:28	
C0-4A-00-0A-AA-F7	TP-LINK_AAF7_5G	5G	36	ON	2018-10-08 17:08:28	

You can execute the corresponding operation to the EAP by clicking an icon in the **Action** column:

- Move the trusted rogue AP to the Untrusted Rogue APs list.
- Export** Export and download the current Trusted Rogue APs list and save it on your PC.



Import a saved Trusted Rogue APs list. If the MAC address of an AP appears in list, it will not be detected as a rogue AP.

Import Trusted AP List

Import Mode: Replace Merge

Import Source File:

Please follow the steps below:

1. Select **Replace** (replace the current Trusted Rogue APs list with the one you import) or **Merge** (add the APs in the file to the current Trusted Rogue APs list).
2. Click **Browse** to locate the file and choose it.
3. Click **Import** to import the Trusted Rogue APs list.

2.7 View Past Guest Authorization

The Past Guest Authorization page displays the details about all the clients that accessed the network during a certain time period. You can select a period in the drop-down list.

MAC Address	SSID	Radio	Authorized By	Authorized Start Time	Download	Upload
D0-A6-37-83-DA-99	SSID2	2.4GHz	Simple Password	2018-10-08 14:23:32	853.76 K	281.81 K

2.8 View Logs



The logs of Omada Controller can effectively record, classify and manage the system information of the managed EAPs, providing powerful support for you to monitor network operation and diagnose malfunctions. The Log page displays the log's module, level, content, operator and occurred time.

Module	Level	Content	Operator	Time	Action
AP	Alert	EA-33-51-A8-22-A0(EA-33-51-A8-22-A0) disconnected from LAN	---	2018-12-14 15:46:11	
System	Information	admin(administrator) logged in successfully	admin	2018-12-14 15:44:13	
AP	Information	EA-23-51-06-22-52(EA-23-51-06-22-52) connected to LAN	---	2018-12-14 15:43:54	
System	Information	admin(administrator) logged in successfully	admin	2018-12-14 15:38:34	
AP	Information	EA-33-51-A8-22-A0(EA-33-51-A8-22-A0) connected to LAN	---	2018-12-14 15:34:19	
AP	Notice	EA-33-51-A8-22-A0(EA-33-51-A8-22-A0) changed LAN IP and mask to 10.0.0.195/255.255.252.0	---	2018-12-14 15:33:20	
AP	Notice	EA-33-51-A8-22-A0(EA-33-51-A8-22-A0) changed LAN IP and mask to 192.168.0.254/255.255.255.0	---	2018-12-14 15:33:17	
System	Information	admin(administrator) logged in successfully	admin	2018-12-14 15:32:17	
AP	Information	EA-33-51-A8-22-A0(EA-33-51-A8-22-A0) connected to LAN	---	2018-12-14 15:29:40	
AP	Information	EA-23-51-06-22-52(EA-23-51-06-22-52) connected to LAN	---	2018-12-14 11:31:33	

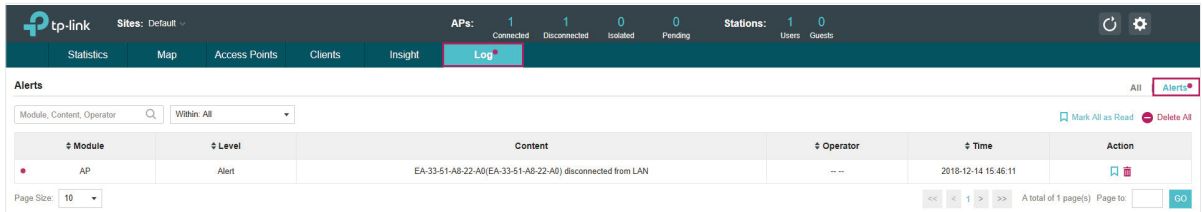
You can view the alerts on a separate page by clicking **Alerts** in the top right corner of the page. As follows, you can click  to mark the alerts as read.



The screenshot shows the TP-Link controller interface. The top navigation bar includes 'Log' and 'Alerts' (highlighted). The Alerts page shows a table with one alert:

Module	Level	Content	Operator	Time	Action
AP	Alert	EA-33-51-A8-22-A0(EA-33-51-A8-22-A0) disconnected from LAN	---	2018-12-14 15:46:11	 

Note:

The logs and alerts of the controller with version 3.0.5 or below will be discarded after the controller is upgraded to version 3.1.4 or above.

3

Configure the EAPs Globally

This chapter introduces the global configurations applied to all the managed EAPs. To configure a specific EAP, please refer to [Chapter 5 Configure the EAPs Separately](#).

In global configurations, you can configure the following items:

- Wireless Network
- Access Control
- Portal Authentication
- Free Authentication Policy
- MAC Filter
- Scheduler
- QoS
- Site Settings

3.1 Wireless Network

In addition to the wireless network you created in Quick Start, you can add more wireless networks and configure the advanced wireless parameters to improve the network quality.

3.1.1 Add Wireless Networks

To add wireless networks, follow the steps below.

1. Go to **Wireless Settings > Basic Wireless Setting**.

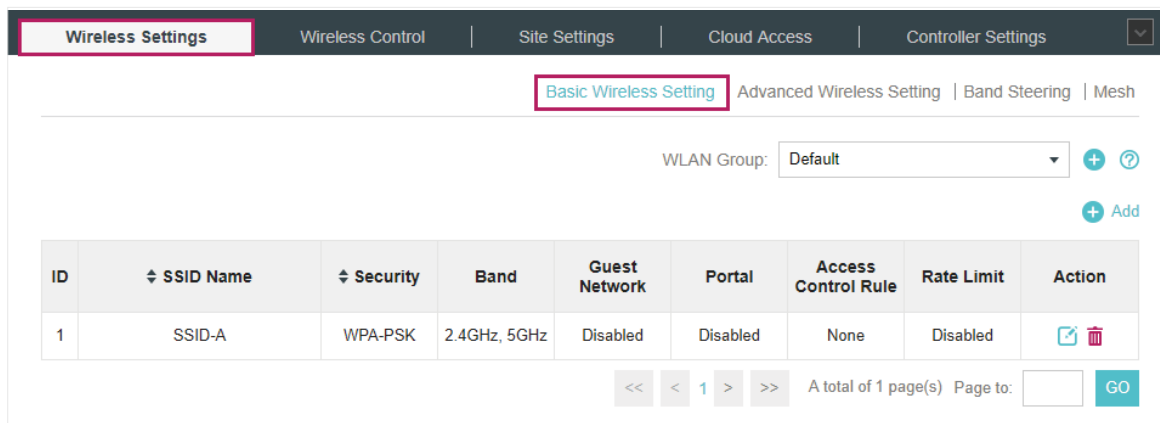

2. Click  at the right of **WLAN Group: Default** to add a WLAN group. Creating WLAN groups is an easy way to quickly deploy EAPs by creating a template-based set of SSIDs with wireless parameters. Different WLAN groups can be applied to different EAPs. If you have no need to group your wireless networks, you can use the default WLAN group and skip this step.
3. Specify a name for the group and click **Apply**.

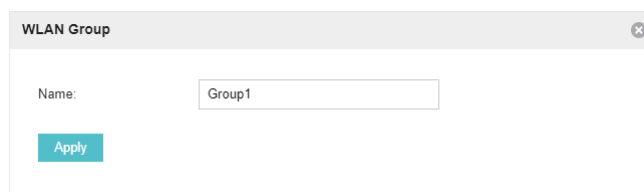

4. Select the WLAN group **WLAN Group: Default** and click  **Add** to add an SSID to the specific WLAN group.
5. Configure the parameters in the following window.

Add SSID ✕

Basic Info ↑

SSID Name:

Band: 2.4GHz 5GHz

Guest Network: Enable ?

Security Mode: WPA-PSK ▼

Wireless Password: 🔒

Advanced Settings ⌵

Apply

SSID Name	Enter an SSID name using up to 32 characters.
Band	Select the radio band to add the SSID.
Guest Network	With this option enabled, the network act as a guest network. All the clients connecting to the SSID will be blocked from reaching any private IP subnet.
Security Mode	<p>Select the security mode of the wireless network.</p> <p>None: The hosts can access the wireless network without authentication.</p> <p>WEP/WPA-Enterprise/WPA-PSK: The hosts need to get authenticated before accessing the wireless network. For the network security, you are suggested to encrypt your wireless network.</p> <p>Settings vary in different security modes and the details are in the following introduction.</p>

Note:

- 8 SSIDs can be created on each band at most.
- The SSID on different radio band with the same name will be regarded as an identical SSID entry. When you upgrade your controller or restore the backup files from the controller with the version 3.0.5 or below, the SSID entries with the same name will be merged if they are on 2.4GHz and 5GHz in the same WLAN group. All the configurations in the entry will be changed to the parameters of the original SSID on the 2.4GHz radio band.

Following is the detailed introduction of **None**, **WEP**, **WPA-Enterprise** and **WPA-PSK**.

None

The hosts can access the wireless network without authentication. Configure the advanced parameters in the following window.

Add SSID ✕

Basic Info ⌵

Advanced Settings ⌴

SSID Broadcast: Enable

Wireless VLAN: Enable

Wireless VLAN ID: (1-4094)

RADIUS MAC Authentication: Enable

Authentication Server IP:

Authentication Server Port: (1-65535)

Authentication Server Password: 🔍

MAC Address Format: ?

Empty Password: ?

Access Control Rule: ⌵

Rate Limit: Enable ?

Download Limit: Kbps (0-10240000. 0 means no limit.)

Upload Limit: Kbps (0-10240000. 0 means no limit.)

SSID Broadcast

With the option enabled, EAPs will broadcast the SSID to the nearby hosts, so that those hosts can find the wireless network identified by this SSID. If this option is disabled, users must enter the SSID manually to connect to the EAP.

The option is enabled by default.

Wireless VLAN	<p>With this option enabled, the EAP can work together with the switches supporting 802.1Q VLAN. Traffic from the clients in different wireless networks is added with different VLAN tags according to the VLAN settings of the wireless networks. Then the wireless clients in different VLANs cannot directly communicate with each other.</p> <p>To set a wireless VLAN for the wireless network, enable the option and set a VLAN ID in the Wireless VLAN ID.</p>
Wireless VLAN ID	Enter a VLAN ID for the wireless VLAN. Wireless networks with the same VLAN ID are grouped to a VLAN. The value ranges from 1 to 4094.
RADIUS MAC Authentication	<p>With this option enabled, the EAP will send the MAC address of the client to the RADIUS server as the username and password for authentication. If the authorization succeeds, the RADIUS server grants the client access to the network.</p> <p>To set RADIUS MAC Authentication, enable the option and configure the following parameters: Authentication Server IP, Authentication Server Port, Authentication Server Password, MAC Address Format, and Empty Password.</p>
Authentication Server IP	With RADIUS MAC Authentication enabled, enter the IP address of the authentication server.
Authentication Server Port	With RADIUS MAC Authentication enabled, enter the port number you have set on the RADIUS server for authentication requests. The default setting is 1812.
Authentication Server Password	With RADIUS MAC Authentication enabled, enter the authentication password. The authentication server and the controller use the password to encrypt passwords and exchange responses.
MAC Address Format	With RADIUS MAC Authentication enabled, select the format to convert a client's MAC address to the RADIUS username.
Empty Password	With the option enabled, a blank password for RADIUS MAC Authentication will be allowed. With the option disabled, the password will be the same as the username.
Access Control Rule	Select an Access Control rule for this SSID. For more information, refer to Access Control .
Rate Limit	<p>With this option enabled, the download and upload rate of each client which connects to the SSID will be limited to balance bandwidth usage. You can limit the download and upload rate for some specific clients by configuring rate limit in client list, refer to Manage Clients in the Action Column to get more details.</p> <p>Note that the download and upload rate will be limited to the minimum of the value configured in SSID, client and portal configuration.</p>
Download Limit	With Rate Limit enabled, specify the limit of download rate. 0 means unlimited.
Upload Limit	With Rate Limit enabled, specify the limit of upload rate. 0 means unlimited.

WEP

WEP is based on the IEEE 802.11 standard and less safe than WPA-Enterprise and WPA-PSK.

Note:

WEP is not supported in 802.11n mode or 802.11ac mode. If WEP is applied in 802.11n, 802.11 ac or 802.11n/ac mixed mode, the clients may not be able to access the wireless network. If WEP is applied in 11b/g/n mode (2.4GHz) or 11a/n (5GHz), the EAP may work at a low transmission rate.

Security Mode:	WEP
Key Selected:	Key1
Key Value:	weppw

Key Selected	Select one key to specify. You can configure four keys at most.
--------------	---

Key Value	Enter the WEP keys. The length and valid characters are affected by key type.
-----------	---

Configure the advanced parameters in the following window.

Add SSID ✕

Basic Info ⌵

Advanced Settings ⌶

Type: Auto Open System Shared Key

WEP Key Format: ASCII Hexadecimal

Key Type: 64Bit 128Bit 152Bit

SSID Broadcast: Enable

Wireless VLAN: Enable

Wireless VLAN ID: (1-4094)

Access Control Rule: ⌵

Rate Limit: Enable ?

Download Limit: Kbps (0-10240000. 0 means no limit.)

Upload Limit: Kbps (0-10240000. 0 means no limit.)

Type	<p>Select the authentication type for WEP.</p> <p>Auto: The Omada Controller can select Open System or Shared Key automatically based on the wireless station's capability and request.</p> <p>Open System: Clients can pass the authentication and associate with the wireless network without password. However, correct password is necessary for data transmission.</p> <p>Shared Key: Clients have to input password to pass the authentication, otherwise it cannot associate with the wireless network or transmit data.</p>
WEP Key Format	<p>Select ASCII or Hexadecima as the WEP key format.</p> <p>ASCII: ASCII format stands for any combination of keyboard characters of the specified length.</p> <p>Hexadecimal: Hexadecimal format stands for any combination of hexadecimal digits (0-9, a-f, A-F) with the specified length.</p>
Key Type	<p>Select the WEP key length for encryption.</p> <p>64Bit: Enter 10 hexadecimal digits or 5 ASCII characters.</p> <p>128Bit: Enter 26 hexadecimal digits or 13 ASCII characters.</p> <p>152Bit: Enter 32 hexadecimal digits or 16 ASCII characters.</p>
Key Value	<p>Enter the WEP keys. The length and valid characters are affected by key type.</p>
SSID Broadcast	<p>With the option enabled, EAPs will broadcast the SSID to the nearby hosts, so that those hosts can find the wireless network identified by this SSID. If this option is disabled, users must enter the SSID manually to connect to the EAP.</p> <p>The option is enabled by default.</p>
Wireless VLAN	<p>With this option enabled, the EAP can work together with the switches supporting 802.1Q VLAN. Traffic from the clients in different wireless networks is added with different VLAN tags according to the VLAN settings of the wireless networks. Then the wireless clients in different VLANs cannot directly communicate with each other.</p> <p>To set a wireless VLAN for the wireless network, enable the option and set a VLAN ID in the Wireless VLAN ID.</p>
Wireless VLAN ID	<p>Enter a VLAN ID for the wireless VLAN. Wireless networks with the same VLAN ID are grouped to a VLAN. The value ranges from 1 to 4094.</p>
Access Control Rule	<p>Select an Access Control rule for this SSID. For more information, refer to Access Control.</p>
Rate Limit	<p>With this option enabled, the download and upload rate of each client which connects to the SSID will be limited to balance bandwidth usage. You can limit the download and upload rate for some specific clients by configuring rate limit in client list, refer to Manage Clients in the Action Column to get more details.</p> <p>Note that the download and upload rate will be limited to the minimum of the value configured in SSID, client and portal configuration.</p>
Download Limit	<p>With Rate Limit enabled, specify the limit of download rate. 0 means unlimited.</p>

Upload Limit

With Rate Limit enabled, specify the limit of upload rate. 0 means unlimited.

WPA-Enterprise

The WPA-Enterprise mode requires a RADIUS server to authenticate clients. Since the WPA-Enterprise can generate different passwords for different clients, it is much safer than WPA-PSK. However, it costs much more to maintain and is usually used by enterprise.

Security Mode:	<input type="text" value="WPA-Enterprise"/>	
RADIUS Server IP:	<input type="text" value="0.0.0.0"/>	
RADIUS Port:	<input type="text" value="0"/>	(1-65535,0 means default port 1812)
RADIUS Password:	<input type="password"/>	
RADIUS Accounting:	<input checked="" type="checkbox"/> Enable	
Accounting Server IP:	<input type="text"/>	
Accounting Server Port:	<input type="text" value="1813"/>	(1-65535)
Accounting Server Password:	<input type="password"/>	
Interim Update:	<input checked="" type="checkbox"/> Enable	
Interim Update Interval:	<input type="text" value="600"/>	(s, 60-86400)

RADIUS Server IP	Enter the IP address of the RADIUS Server.
-------------------------	--

RADIUS Port	Enter the port number of the RADIUS Server.
--------------------	---

RADIUS Password	Enter the shared secret key of the RADIUS server.
------------------------	---

RADIUS Accounting	Enable or disable RADIUS Accounting feature.
--------------------------	--

Accounting Server IP	Enter the IP address of the accounting server.
-----------------------------	--

Accounting Server Port	Enter the port number of the accounting server.
-------------------------------	---

Accounting Server Password	Enter the shared secret key of the accounting server.
-----------------------------------	---

Interim Update	With this option enabled, you can specify the duration between accounting information updates. By default, the function is disabled. Enter the appropriate duration between updates for EAPs in Interim Update Interval .
-----------------------	---

Interim Update Interval	With Interim Update enabled, specify the appropriate duration between updates for EAPs. The default duration is 600 seconds.
--------------------------------	--

Configure the advanced parameters in the following window.

Add SSID ✕

Basic Info ⌵

Advanced Settings ⌴

Version: Auto WPA WPA2

Encryption: Auto TKIP AES

Group Key Update Period: seconds(30-8640000, 0 means no upgrade)

SSID Broadcast: Enable

Wireless VLAN: Enable

Wireless VLAN ID: (1-4094)

Access Control Rule: ▼

Rate Limit: Enable ?

Download Limit: Kbps (0-10240000. 0 means no limit.)

Upload Limit: Kbps (0-10240000. 0 means no limit.)

Version

Select the version of WPA-Enterprise.

Auto: The EAP will automatically choose the version used by each client device.

WPA/WPA2: Two versions of Wi-Fi Protected Access.

Encryption

Select the Encryption type.

Auto: The default setting is Auto and the EAP will select TKIP or AES automatically based on the client device's request.

TKIP: Temporal Key Integrity Protocol. TKIP is not supported in 802.11n mode, 802.11ac mode or 802.11n/ac mixed mode. If TKIP is applied in 802.11n, 802.11ac or 802.11n/ac mixed mode, the clients may not be able to access the wireless network of the EAP. If TKIP is applied in 11b/g/n mode (2.4GHz) or 11a/n mode(5GHz), the device may work at a low transmission rate.

AES: Advanced Encryption Standard. We recommend that you select AES as the encryption type because it is more secure than TKIP.

Group Key Update Period

Specify a group key update period, which instructs the EAP how often it should change the encryption keys. The value can be either 0 or 30~8640000 seconds. 0 means no change of the encryption key anytime.

SSID Broadcast	<p>With the option enabled, EAPs will broadcast the SSID to the nearby hosts, so that those hosts can find the wireless network identified by this SSID. If this option is disabled, users must enter the SSID manually to connect to the EAP.</p> <p>The option is enabled by default.</p>
Wireless VLAN	<p>With this option enabled, the EAP can work together with the switches supporting 802.1Q VLAN. Traffic from the clients in different wireless networks is added with different VLAN tags according to the VLAN settings of the wireless networks. Then the wireless clients in different VLANs cannot directly communicate with each other.</p> <p>To set a wireless VLAN for the wireless network, enable the option and set a VLAN ID in the Wireless VLAN ID.</p>
Wireless VLAN ID	<p>Enter a VLAN ID for the wireless VLAN. Wireless networks with the same VLAN ID are grouped to a VLAN. The value ranges from 1 to 4094.</p>
Access Control Rule	<p>Select an Access Control rule for this SSID. For more information, refer to Access Control.</p>
Rate Limit	<p>With this option enabled, the download and upload rate of each client which connects to the SSID will be limited to balance bandwidth usage. You can limit the download and upload rate for some specific clients by configuring rate limit in client list, refer to Manage Clients in the Action Column to get more details.</p> <p>Note that the download and upload rate will be limited to the minimum of the value configured in SSID, client and portal configuration.</p>
Download Limit	<p>With Rate Limit enabled, specify the limit of download rate. 0 means unlimited.</p>
Upload Limit	<p>With Rate Limit enabled, specify the limit of upload rate. 0 means unlimited.</p>

WPA-PSK

Based on a pre-shared key, WPA-PSK is characterized by high safety and simple settings and is mostly used by common households and small businesses.

Security Mode:

Wireless Password:

Wireless Password	<p>Configure the wireless password with ASCII or Hexadecimal characters.</p> <p>For ASCII, the length should be between 8 and 63 characters with combination of numbers, letters (case-sensitive) and common punctuations. For Hexadecimal, the length should be 64 characters (case-insensitive, 0-9, a-f, A-F).</p>
--------------------------	---

Configure the advanced parameters in the following window.

Add SSID ✕

Basic Info ⌵

Advanced Settings ⌶

Version: Auto WPA-PSK WPA2-PSK

Encryption: Auto TKIP AES

Group Key Update Period: seconds(30-8640000, 0 means no upgrade)

SSID Broadcast: Enable

Wireless VLAN: Enable

Wireless VLAN ID: (1-4094)

Access Control Rule: ▼

Rate Limit: Enable ?

Download Limit: Kbps (0-10240000, 0 means no limit.)

Upload Limit: Kbps (0-10240000, 0 means no limit.)

Version

Select the version of WPA-Enterprise.

Auto: The EAP will automatically choose the version used by each client device.

WPA/WPA2: Two versions of Wi-Fi Protected Access.

Encryption

Select the Encryption type.

Auto: The default setting is Auto and the EAP will select TKIP or AES automatically based on the client request.

TKIP: Temporal Key Integrity Protocol. TKIP is not supported in 802.11n mode, 802.11ac mode or 802.11n/ac mixed mode. If TKIP is applied in 802.11n, 802.11ac or 802.11n/ac mixed mode, the clients may not be able to access the wireless network of the EAP. If TKIP is applied in 11b/g/n mode (2.4GHz) or 11a/n mode(5GHz), the device may work at a low transmission rate.

AES: Advanced Encryption Standard. We recommend that you select AES as the encryption type for it is more secure than TKIP.

Group Key Update Period

Specify a group key update period, which instructs the EAP how often it should change the encryption keys. The value can be either 0 or 30~8640000 seconds. 0 means the encryption keys will not be changed all the time.

SSID Broadcast	<p>With the option enabled, EAPs will broadcast the SSID to the nearby hosts, so that those hosts can find the wireless network identified by this SSID. If this option is disabled, users must enter the SSID manually to connect to the EAP.</p> <p>The option is enabled by default.</p>
Wireless VLAN	<p>With this option enabled, the EAP can work together with the switches supporting 802.1Q VLAN. Traffic from the clients in different wireless networks is added with different VLAN tags according to the VLAN settings of the wireless networks. Then the wireless clients in different VLANs cannot directly communicate with each other.</p> <p>To set a wireless VLAN for the wireless network, enable the option and set a VLAN ID in the Wireless VLAN ID.</p>
Wireless VLAN ID	<p>Enter a VLAN ID for the wireless VLAN. Wireless networks with the same VLAN ID are grouped to a VLAN. The value ranges from 1 to 4094.</p>
Access Control Rule	<p>Select an Access Control rule for this SSID. For more information, refer to Access Control.</p>
Rate Limit	<p>With this option enabled, the download and upload rate of each client which connects to the SSID will be limited to balance bandwidth usage. You can limit the download and upload rate for some specific clients by configuring rate limit in client list, refer to Manage Clients in the Action Column to get more details.</p> <p>Note that the download and upload rate will be limited to the minimum of the value configured in SSID, client and portal configuration.</p>
Download Limit	<p>With Rate Limit enabled, specify the limit of download rate. 0 means unlimited.</p>
Upload Limit	<p>With Rate Limit enabled, specify the limit of upload rate. 0 means unlimited.</p>

6. Click **Apply**.

3.1.2 Configure Advanced Wireless Parameters

Proper wireless parameters can improve the network's stability, reliability and communication efficiency. The advanced wireless parameters consist of **Fast Roaming**, **Beacon Interval**, **DTIM Period**, **RTS Threshold**, **Fragmentation Threshold** and **Airtime Fairness**.

To configure the advanced wireless parameters, follow the steps below.

1. Go to **Wireless Settings > Advanced Wireless Setting**.

Wireless Settings | Wireless Control | Site Settings | Cloud Access | Controller Settings

Basic Wireless Setting | **Advanced Wireless Setting** | Band Steering | Mesh

Roaming Setting

Fast Roaming: Enable ?

Apply

2.4GHz | 5GHz

Beacon Interval: ms(40-100)

DTIM Period: (1-255)

RTS Threshold: (1-2347)

Fragmentation Threshold: (256-2346, works only in 11b/g mode)

Airtime Fairness: Enable ?

Apply

2. Enable **Fast Roaming** and configure the corresponding parameters.

Roaming Setting

Fast Roaming: Enable ?

Dual Band 11k Report: Enable ?

Force-disassociation: Enable ?

Fast Roaming	With this option enabled, 11k/v capable clients can have improved fast roaming experience when moving among different APs.
Dual Band 11k Report	With this feature disabled, the controller provides candidate AP report that contains the APs in the same band as the clients. With this feature enabled, the controller provides candidate AP report that contains the APs in both 2.4GHz and 5GHz bands.
Force-disassociation	<p>The controller dynamically monitors the link quality of every associated client. When the client's current link quality drops below the predefined threshold and there are some other APs with better signal, the current AP issues an 11v roaming suggestion to the client.</p> <p>With Force-disassociation disabled, the AP only issues a roaming suggestion, but whether to roam or not is determined by the client.</p> <p>With Force-disassociation enabled, the AP not only issues a roaming suggestion but also disassociates the client after a while. Thus the client is supported to re-associate to a better AP. This function is recommended when there are sticky clients that don't roam.</p>

3. Click **Apply**.

4. Select the band frequency 2.4GHz 5GHz .

5. Configure the following parameters.

Beacon Interval	<p>Beacons are transmitted periodically by the EAP to announce the presence of a wireless network for the clients. Beacon Interval value determines the time interval of the beacons sent by the device.</p> <p>You can specify a value between 40 and 100ms. The default is 100ms.</p>
DTIM Period	<p>The DTIM (Delivery Traffic Indication Message) is contained in some Beacon frames. It indicates whether the EAP has buffered data for client devices. The DTIM Period indicates how often the clients served by this EAP should check for buffered data still on the EAP awaiting pickup.</p> <p>You can specify the value between 1-255 Beacon Intervals. The default value is 1, indicating clients check for buffered data on the EAP at every beacon. An excessive DTIM interval may reduce the performance of multicast applications, so we recommend that you keep it by default.</p>
RTS Threshold	<p>RTS (Request to Send) can ensure efficient data transmission. When RTS is activated, the client will send a RTS packet to EAP to inform that it will send data before it send packets. After receiving the RTS packet, the EAP notices other clients in the same wireless network to delay their transmitting of data and informs the requesting client to send data, thus avoiding the conflict of packet. If the size of packet is larger than the RTS Threshold, the RTS mechanism will be activated.</p> <p>If you specify a low threshold value, RTS packets are sent more frequently and help the network recover from interference or collisions that might occur on a busy network. However, it also consumes more bandwidth and reduces the throughput of the packet. We recommend that you keep it by default. The recommended and default value is 2347.</p>
Fragmentation Threshold	<p>The fragmentation function can limit the size of packets transmitted over the network. If a packet exceeds the Fragmentation Threshold, the fragmentation function is activated and the packet will be fragmented into several packets.</p> <p>Fragmentation helps improve network performance if properly configured. However, too low fragmentation threshold may result in poor wireless performance caused by the extra work of dividing up and reassembling of frames and increased message traffic. The recommended and default value is 2346 bytes.</p>
Airtime Fairness	<p>With this option enabled, each client connecting to the EAP can get the same amount of time to transmit data, avoiding low-data-rate clients to occupy too much network bandwidth and improving the network throughput. We recommend that you enable this function under multi-rate wireless networks.</p>

6. Click **Apply**.

3.1.3 Configure Band Steering

A client device that is capable of communicating on both the 2.4GHz and 5GHz frequency bands will typically connect to the 2.4GHz band. However, if too many client devices are connected to an EAP on the 2.4GHz band, the efficiency of communication will be diminished. Band Steering can steer

dual-band clients to the 5GHz frequency band which supports higher transmission rates and more client devices, and thus to greatly improve the network quality.

To configure Band Steering, follow the steps below.

1. Go to **Wireless Settings > Band Steering**.

The screenshot shows the 'Wireless Settings' page with the 'Band Steering' tab selected. The 'Band Steering' checkbox is unchecked. The 'Connection Threshold' is set to 20, 'Difference Threshold' is set to 4, and 'Max Failures' is set to 10. There is an 'Apply' button and a note at the bottom.

Parameter	Value	Range
Band Steering	<input type="checkbox"/> Enable	
Connection Threshold	20	(2-40)
Difference Threshold	4	(1-8)
Max Failures	10	(0-100)

Note: To run the Band Steering function on a SSID, please create the SSIDs on both of the 2GHz and 5GHz band and make sure they have the same name, security mode and wireless password.

2. Check the box to enable the Band Steering function.
3. Configure the following parameters to balance the clients on both frequency bands:

Connection Threshold/ Difference Threshold

Connection Threshold defines the maximum number of clients connected to the 5GHz band. The value of **Connection Threshold** is from 2 to 40, and the default is 20.

Difference Threshold defines the maximum difference between the number of clients on the 5GHz band and 2.4GHz band. The value of **Difference Threshold** is from 1 to 8, and the default is 4.

When the following two conditions are both met, the EAP prefers to refuse the connection request on 5GHz band and no longer steers other clients to the 5GHz band:

1. The number of clients on the 5GHz band reaches the **Connection Threshold** value.
2. The difference between the number of clients on the 2.4GHz band and 5GHz band reaches the **Difference Threshold** value.

Max Failures

If a client repeatedly attempts to associate with the EAP on the 5GHz band and the number of rejections reaches the value of **Max Failures**, the EAP will accept the request.

The value is from 0 to 100, and the default is 10.

4. Click **Apply**.

3.1.4 Configure Mesh

Mesh is used to establish a wireless network or expand a wired network through wireless connection on 5GHz radio band. In practical application, it can help users to conveniently deploy APs without requiring Ethernet cable. After mesh network establishes, the EAPs can be configured

and managed within Omada controller in the same way as wired EAPs. Meanwhile, because of the ability to self-organize and self-configure, mesh also can efficiently reduce the configuration overhead.

Note:

- Only EAP225-Outdoor with specific firmware (version 1.3 or above) is available for mesh function currently.
- Only the EAPs in the same site can establish a mesh network.

To understand how mesh can be used, the following terms used in Omada Controller will be introduced:

- **Root AP:** The AP is managed by Omada Controller with a wired data connection that can be configured to relay data to and from mesh APs (Downlink AP).
- **Isolated AP:** When the EAP which has been managed before by Omada Controller connects to the network wirelessly and cannot reach the gateway, it goes into the Isolated state.
- **Mesh AP:** An isolated AP will be mesh AP after establishing a wireless connection to the AP with network access.
- **Uplink AP/Downlink AP:** Among mesh APs, the AP that offers the wireless connection for other APs is Uplink AP. A Root AP or an intermediate AP can be the Uplink AP. And the AP that connects to the Uplink AP is called Downlink AP. An uplink AP can offer direct wireless connection for 4 Downlink APs at most.
- **Wireless Uplink:** The action that a Downlink AP connects to the uplink AP.
- **Hops:** In a deployment that uses a root AP and more than one level of wireless uplink with intermediate APs, the uplink tiers can be referred to by root, first hop, second hop and so on. The hops cannot be more than 3.

In a basic mesh network as shown below, there is a root AP that is connected by Ethernet cable, while other isolated APs have no wired data connection. Mesh allows the isolated APs to communicate with pre-configured root AP on the network. Once powered up, factory default or unadopted EAPs can sense the EAP in range and make itself available for adoption within the Omada controller.

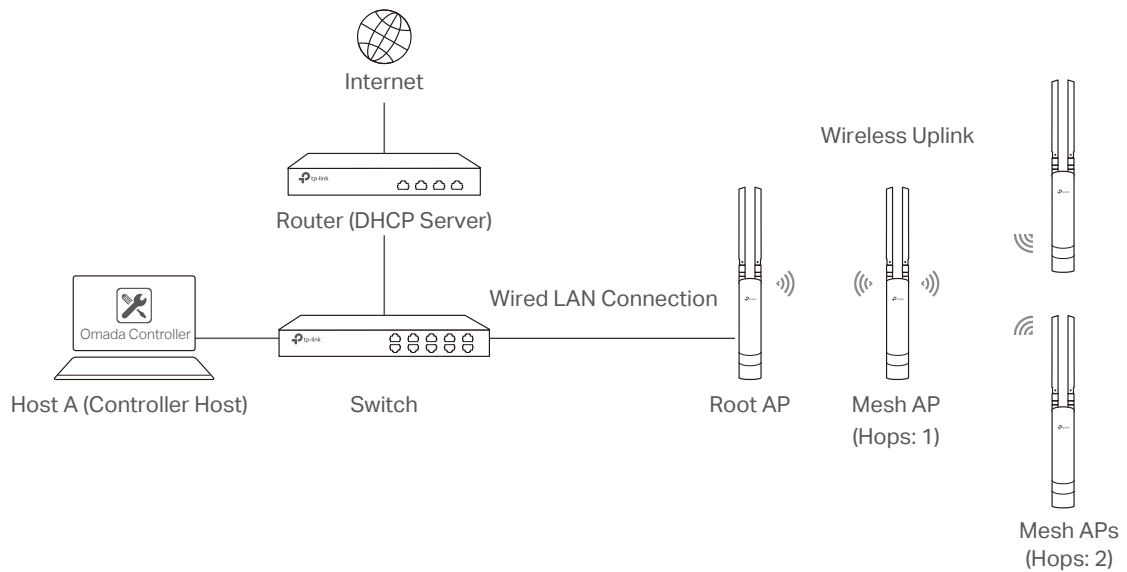

After all the EAPs are adopted, a mesh network is established. Then the EAPs connected to the network wirelessly also can broadcast SSIDs and relay network traffic to and from the network through the uplink AP.

To establish a mesh network, follow the steps below.

- Enable Mesh Function.
- Adopt the Root AP.
- Set up wireless uplink by adopting APs in Pending (Wireless) or Isolated status.

1. Go to **Wireless Settings > Mesh**.

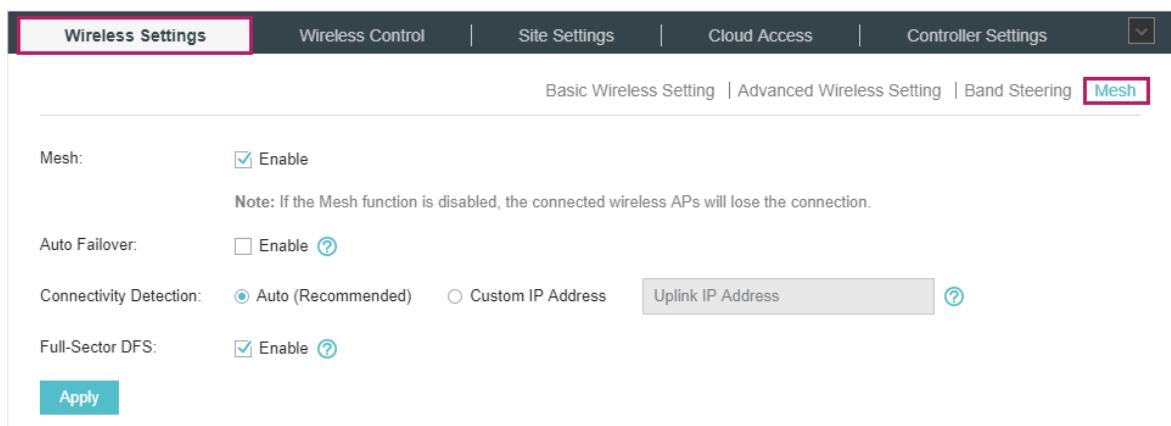

2. Check the box to enable the Mesh function.

3. Configure the following parameters to maintain the mesh network:

Auto Failover

Enable or disable Auto Failover.

Auto Failover is used to automatically maintain the mesh network for the controller. With this feature enabled, the controller can automatically select an uplink AP for the isolated EAP to establish Wireless Uplink. Thus the controller will automatically select a new uplink AP for the mesh EAPs when the original uplink fails.

Connectivity Detection

Specify the method of Connection Detection.

In a mesh network, the APs can send ARP request packets to a fixed IP address to test the connectivity. If the link fails, the status of these APs will change to Isolated.

Auto (Recommended): Select this method and the mesh APs will send ARP request packets to the default gateway for the detection.

Custom IP Address: Select this method and specify a desired IP address. The mesh APs will send ARP request packets to the custom IP address to test the connectivity. If the IP address of the AP is in different network segments from the custom IP address, the AP will use the default gateway IP address for the detection.

Full-Sector DFS

With this feature enabled, when radar signals are detected on current channel by one EAP, the other EAPs in the mesh network will be also informed. Then all EAPs in the mesh network will switch to an alternate channel.

4. Click **Apply**.

5. Go to **Access Points > Pending** and adopt the Root AP. Then the status of the Root AP will change into Connected.

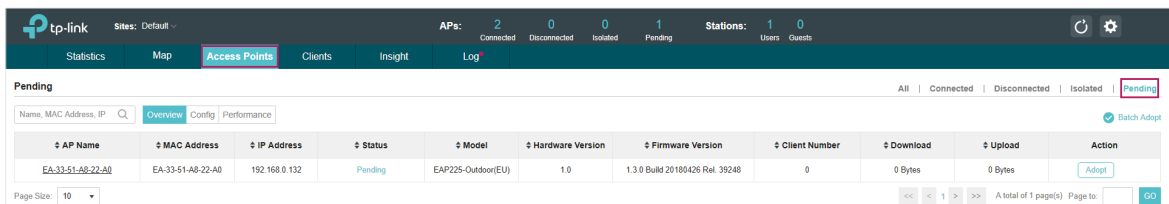

The screenshot shows the TP-Link Omada Controller interface. The top navigation bar includes 'Statistics', 'Map', 'Access Points', 'Clients', 'Insight', and 'Log'. The 'Access Points' section is active, showing a summary of APs: 2 Connected, 0 Disconnected, 0 Isolated, and 1 Pending. Below this, the 'Pending' tab is selected, displaying a table of pending APs. The table has columns for AP Name, MAC Address, IP Address, Status, Model, Hardware Version, Firmware Version, Client Number, Download, Upload, and Action. One AP is listed with the status 'Pending'.

AP Name	MAC Address	IP Address	Status	Model	Hardware Version	Firmware Version	Client Number	Download	Upload	Action
EA-33-51-A9-22-A0	EA-33-51-A9-22-A0	192.168.0.132	Pending	EAP225-Outdoor(EU)	1.0	1.3.0 Build 20180426 Rel. 39248	0	0 Bytes	0 Bytes	Adopt

6. Install the EAP that will uplink the Root AP wirelessly. Make sure the intended location is within the range of Root AP. The EAPs that is waiting for Wireless Uplink includes two cases: factory default EAPs and EAPs that has been managed by Omada Controller before.

- 1) For the factory default EAP, after powering on the device, the EAP will be in Pending (Wireless) status shown in the controller. Go to **Access Points > Pending** and adopt the EAPs in Pending (Wireless) status.

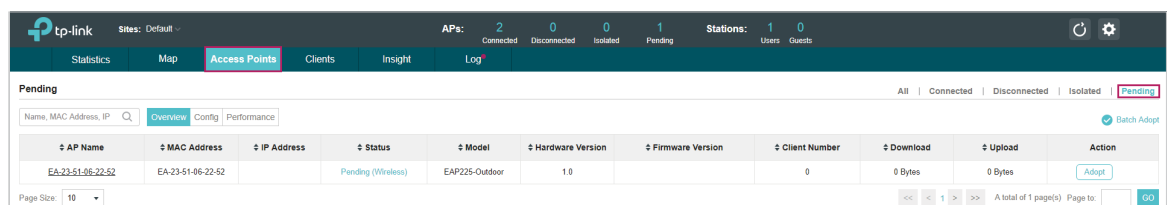

The screenshot shows the TP-Link Omada Controller interface. The top navigation bar includes 'Statistics', 'Map', 'Access Points', 'Clients', 'Insight', and 'Log'. The 'Access Points' section is active, showing a summary of APs: 2 Connected, 0 Disconnected, 0 Isolated, and 1 Pending. Below this, the 'Pending' tab is selected, displaying a table of pending APs. The table has columns for AP Name, MAC Address, IP Address, Status, Model, Hardware Version, Firmware Version, Client Number, Download, Upload, and Action. One AP is listed with the status 'Pending (Wireless)'.

AP Name	MAC Address	IP Address	Status	Model	Hardware Version	Firmware Version	Client Number	Download	Upload	Action
EA-23-51-08-22-52	EA-23-51-08-22-52		Pending (Wireless)	EAP225-Outdoor	1.0		0	0 Bytes	0 Bytes	Adopt

After adoption begins, the status of Pending (Wireless) EAP will become Adopting (Wireless) and then Connected (Wireless). It should take roughly 2 minutes to show up Connected (Wireless) within your controller.

2) For the EAP that has been managed by Omada Controller before and cannot reach the gateway, it goes into Isolated status when it is discovered by controller again. Go to **Access Points > Isolated**, click .

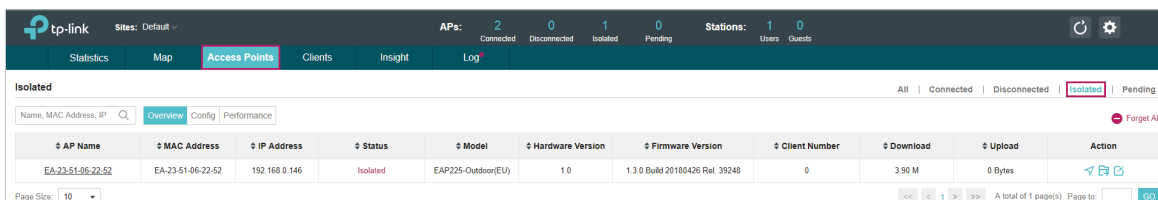

The following page will shown, go to **Mesh**, then click [Link](#) to connect the Uplink AP.

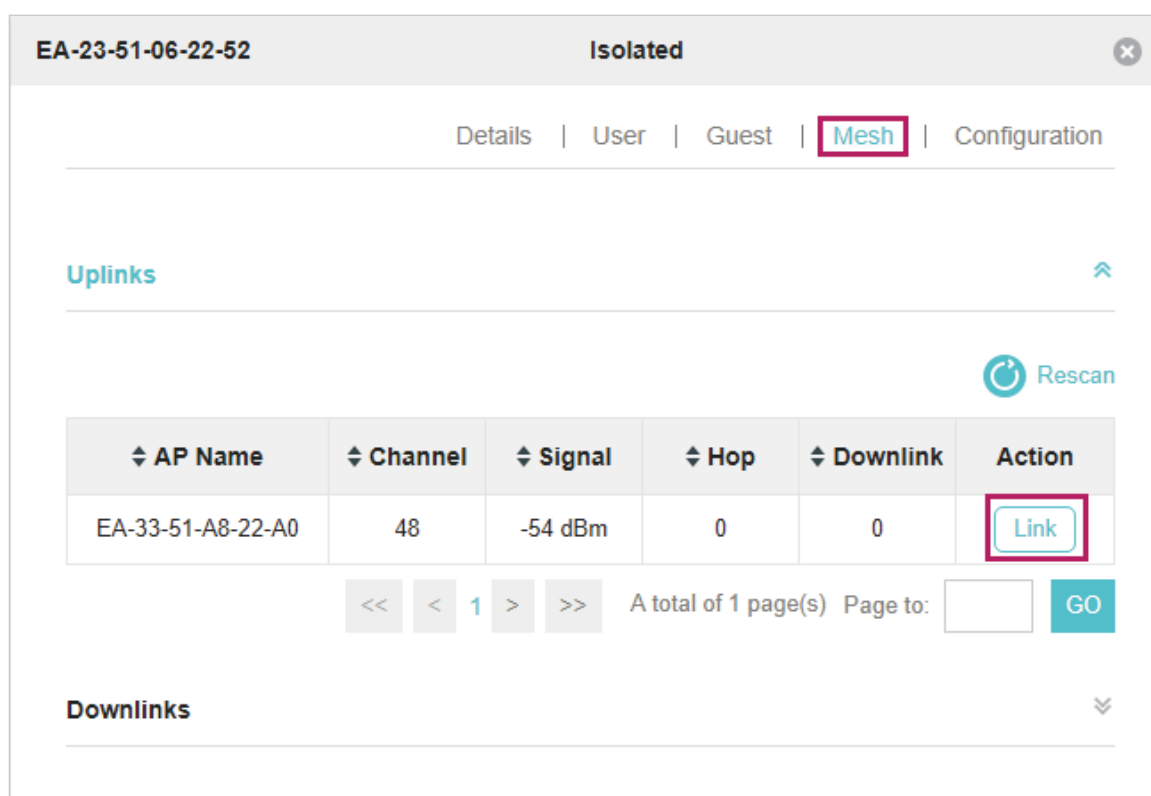

Once adoption has finished, your device can be managed by the controller in the same way as a wired EAP. You can click the EAP's name on the Access Points tab to view and configure the mesh parameters of the EAP on the pop-up window. Please refer to [View Mesh Information of the EAP](#).

Tips:

- You can manually select the uplink AP that you want to connect in the uplink EAP list. To build a mesh network with better performance, we recommend that you select the Uplink AP with the strongest signal, least hop and least Downlink AP.
- You can enable **Auto Failover** to make the controller automatically select an uplink AP for the isolated EAP to establish Wireless Uplink. And the controller will automatically select a new uplink AP for the mesh EAPs when the original uplink fails.

3.2 Access Control

Access Control is used to block or allow the clients to access specific subnets. To configure Access Control rules, follow the steps below.

1. Go to **Wireless Control > Access Control**.

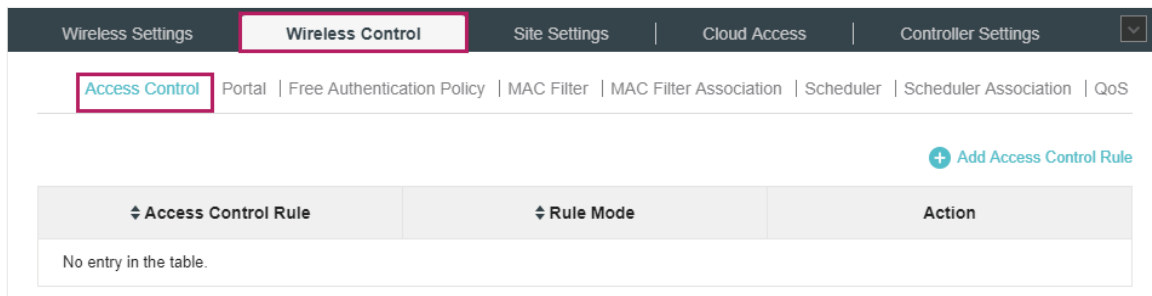

2. Click **+ Add Access Control Rule** to add a new Access Control rule.

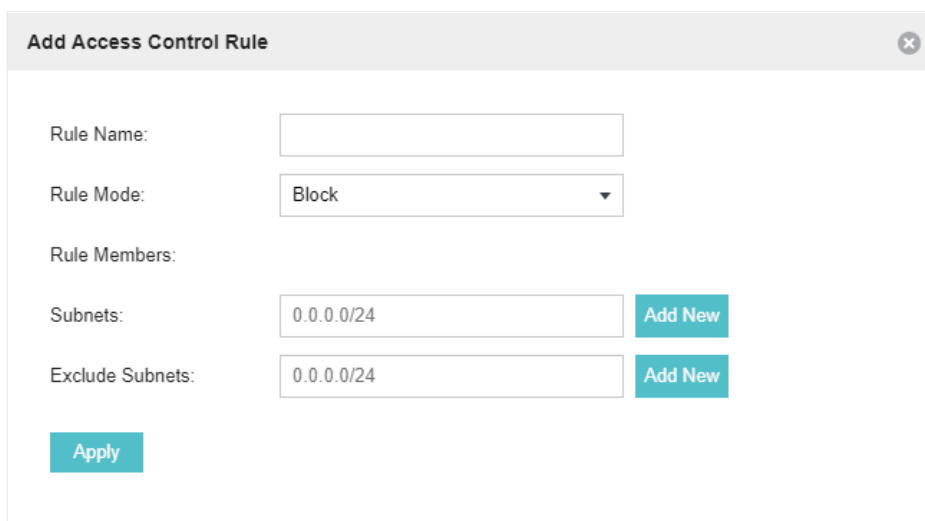
The 'Add Access Control Rule' dialog box is shown. It contains the following fields and controls:

- Rule Name:** An empty text input field.
- Rule Mode:** A dropdown menu currently set to 'Block'.
- Rule Members:** A section containing two rows:
 - Subnets:** A text input field containing '0.0.0.0/24' and an 'Add New' button.
 - Exclude Subnets:** A text input field containing '0.0.0.0/24' and an 'Add New' button.
- Apply:** A large teal button at the bottom left.

3. Configure the following parameters.

Rule Name	Specify a name for this rule.
Rule Mode	Select the mode for this rule. Block: Select this mode to block clients to access the specific subnets. Allow: Select this mode to allow clients to access the specific subnets.
Rule Members	Specify the member subnets for this rule. Subnets: Enter the subnet that will follow the rule mode in the format X.X.X.X/X and click Add New . Up to 16 subnets can be added. Except Subnets: Enter the excepted subnet in the format X.X.X.X/X and click Add New . Up to 16 subnets can be added. The rule mode will not apply to the subnet that is in both of the Subnets list and Except Subnets list.

4. Click **Apply**.

5. Go to **Wireless Settings > Basic Wireless Setting** and enable Access Control function of a selected SSID.

3.3 Portal Authentication

Portal authentication enhances the network security by providing authentication service to the clients that just need temporary access to the wireless network. Such clients have to log into a web page to establish verification, after which they will access the network as guests. What's more, you can customize the authentication login page and specify a URL which the newly authenticated clients will be redirected to.

To configure Portal Authentication, go to **Wireless Control > Portal** and click  **Add a New Portal**.

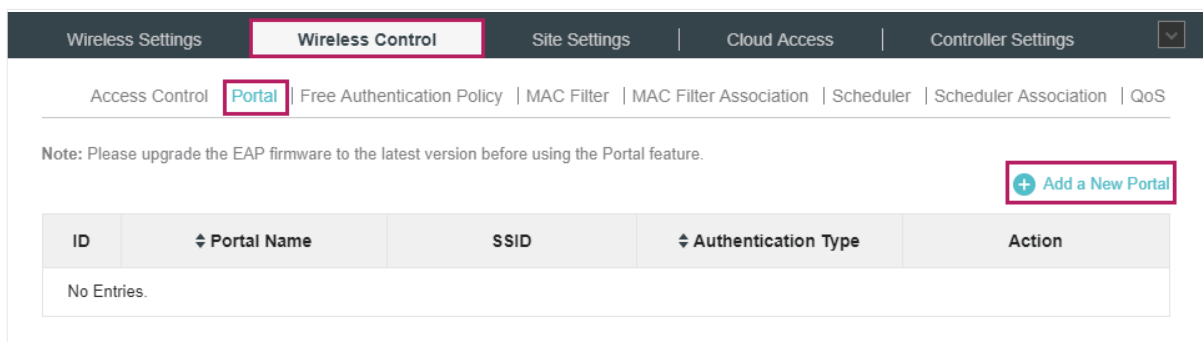

Then the following window will pop up:

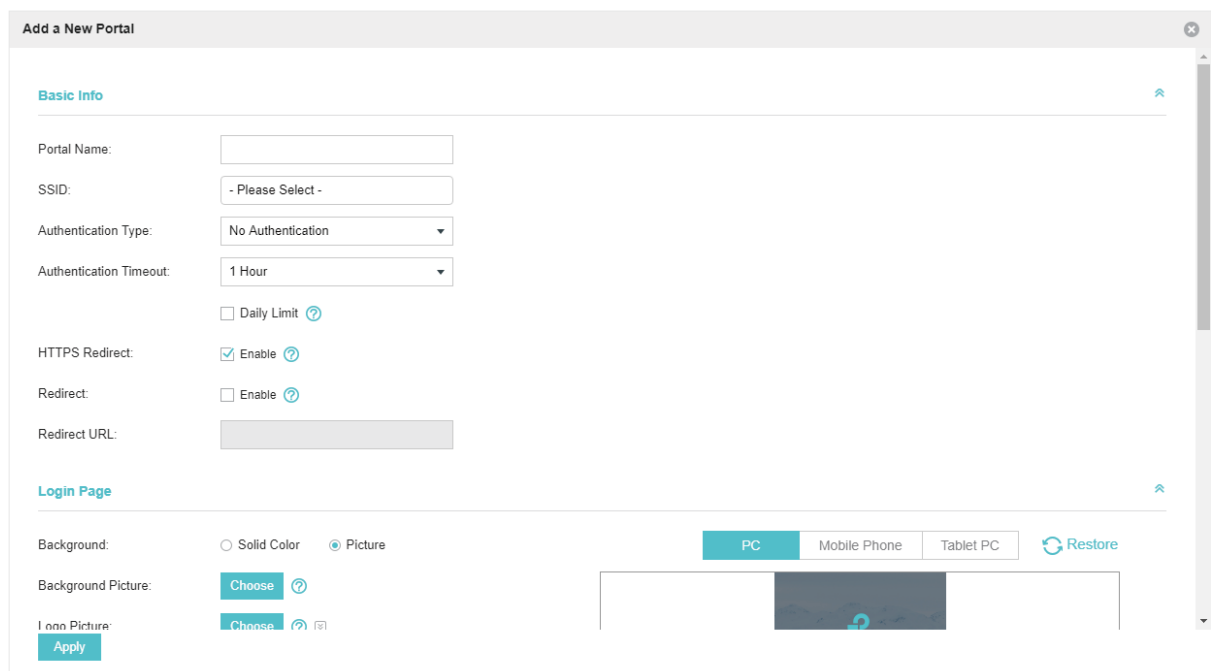

These authentication methods are available: [No Authentication](#), [Simple Password](#), [Local User](#), [Voucher](#), [SMS](#), [Facebook](#), [External RADIUS Server](#) and [External Portal Server](#). The following sections introduce how to configure each Portal authentication.

3.3.1 No Authentication

With No Authentication configured, clients can access the network without any authentication.

Follow the steps below to configure No Authentication:

1. Go to **Wireless Settings > Basic Wireless Settings** and create an SSID for the Portal.
2. Go back to the Portal configuration page. In the **Basic Info** section, complete the basic settings for the portal authentication.

The screenshot shows the 'Basic Info' configuration page. It includes the following fields and options:

- Portal Name:
- SSID:
- Authentication Type:
- Authentication Timeout:
- Daily Limit:
- HTTPS Redirect:
- Redirect:
- Redirect URL:

Configure the following parameters:

Portal Name	Specify a name for the Portal.
SSID	Select an SSID for the Portal.
Authentication Type	Select No Authentication .
Authentication Timeout	<p>With Daily Limit disabled, the client's authentication will expire after the time period you set and the client needs to log in again on the web authentication page to access the network.</p> <p>Options include 1 Hour, 8 Hours, 24 Hours, 7 Days and Custom. Custom allows you to define the time in days, hours and minutes. The default value is one hour.</p> <p>With Daily Limit enabled, the client's authentication will expire after the time period you set and the client cannot log in again in the same day.</p> <p>Options include 30 Minutes, 1 Hour, 2 Hours, 4 Hours and Custom. Custom allows you to define the time in hours and minutes. The default value is 30 minutes.</p>
Daily Limit	With Daily Limit enabled, after authentication times out, the user cannot get authenticated again in the same day.
HTTPS Redirect	<p>With this function enabled, the unauthorized clients will be redirected to the Portal page when they are trying to browse HTTPS websites.</p> <p>With this function disabled, the unauthorized clients cannot browse HTTPS websites and are not redirected to the Portal page.</p>

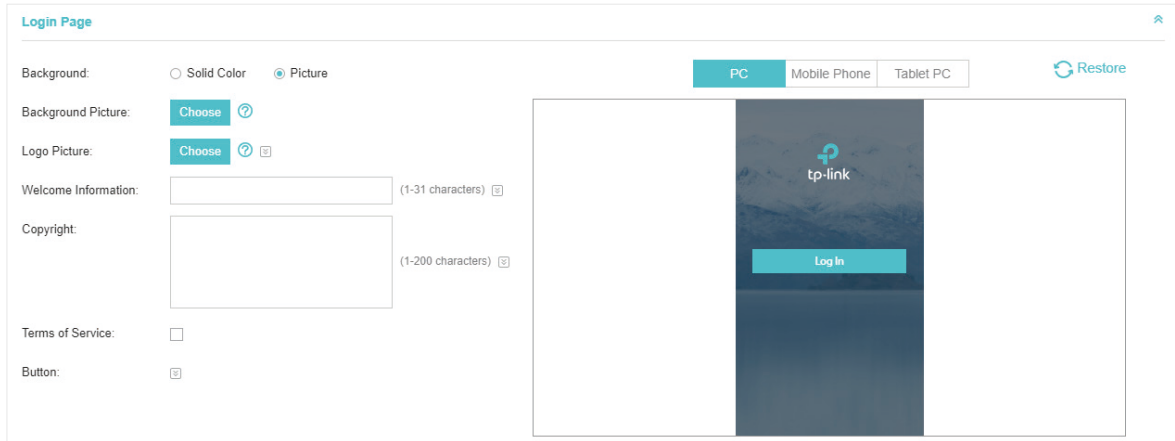

Redirect	If you enable this function, the portal will redirect the newly authenticated clients to the configured URL.
Redirect URL	If the Redirect function above is enabled, enter the URL that a newly authenticated client will be redirected to.

3. In the **Login Page** section, configure the login page for the Portal.



Configure the following parameters:

Background	Select the background type. Two types are supported: Solid Color and Picture .
Background Color	If Solid Color is selected, configure your desired background color through the color picker or by entering the RGB value manually.
Background Picture	If Picture is selected, click the Choose button and select a picture from your PC. Drag and scale the clipping region to edit the picture and click Confirm .
Logo Picture	Click the Choose button and select a picture from your PC. Drag and scale the clipping region to edit the picture and click Confirm . In addition, you can click  and configure the logo position. The options include Middle , Upper and Lower .

Logo Picture: Choose  

Logo Position: Middle 

Welcome Information

Specify the welcome information.

In addition, you can click and select your desired text color for the welcome information through the color picker or by entering the RGB value manually.

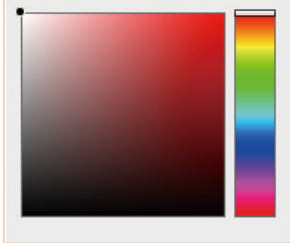
Welcome Information:	<input type="text"/>	(1-31 characters) <input type="checkbox"/>
	<input type="text" value="#ffffff"/>	(RGB value)
Welcome Information Color:		

Copyright

Specify the copyright information.

In addition, you can click and select your desired text color for Copyright information through the color picker or by entering the RGB value manually.

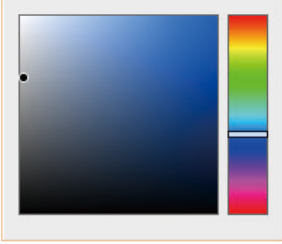
Copyright:	<input type="text"/>	(1-200 characters) <input type="checkbox"/>
	<input type="text" value="#A7A9AC"/>	(RGB value)
Copyright Color:		

Terms of Service

Enable or disable Terms of Service. With this option enabled, specify the terms of service in the following box.

Terms of Service:	<input checked="" type="checkbox"/> Enable
<div style="border: 1px solid #ccc; height: 80px; width: 100%;"></div>	

Button

Click  and configure the button.

Button Position: Set the position of the login button. The options include **Middle**, **Upper** and **Lower**.

Button Color: Select your desired login button color through the color picker or by entering the RGB value manually.

Button Text Color: Select your desired text color for the button through the color picker or by entering the RGB value manually.

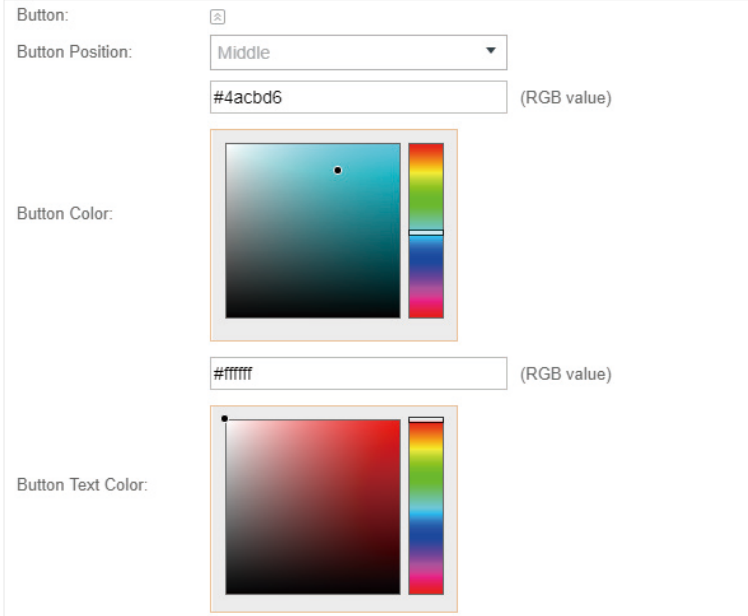

Button: 

Button Position: Middle

#4acbd6 (RGB value)

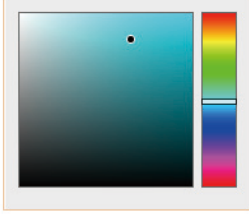
Button Color: 

#ffffff (RGB value)

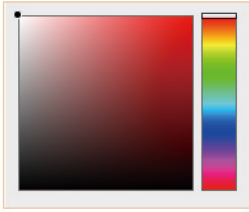
Button Text Color: 

4. In the **Advertisement** section, select whether to display advertisement pictures for users and configure the related parameters.

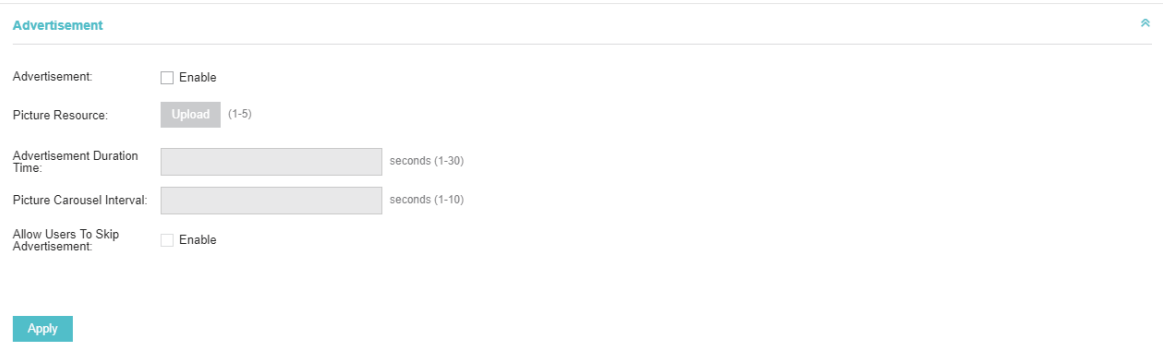

Advertisement

Advertisement: Enable

Picture Resource: (1-5)

Advertisement Duration Time: seconds (1-30)

Picture Carousel Interval: seconds (1-10)

Allow Users To Skip Advertisement: Enable

Configure the following parameters:

Advertisement

Specify whether to enable the Advertisement feature. With this feature enabled, you can add advertisement pictures on the authentication page. These advertisement pictures will be displayed before the login page appears. You can also allow users to skip the advertisement by enabling **Allow Users To Skip Advertisement**. The advertisement picture should be less than 2MB. And only JPG, PNG, BMP, GIF and JPEG file types are supported.

Picture Resource	Upload advertisement pictures. When several pictures are added, they will be played in a loop.
Advertisement Duration Time	Specify how long the advertisement will be displayed for. For this duration, the pictures will be played in a loop. If the duration time is not enough for all the pictures, the rest will not be displayed.
Picture Carousel Interval	Specify the picture carousel interval. For example, if this value is set as 5 seconds, the first picture will be displayed for 5 seconds, followed by the second picture for 5 seconds, and so on.
Allow Users To Skip Advertisement	Specify whether to enable this feature. With this feature enabled, the user can click the Skip button to skip the advertisement.

5. Click **Apply**.

3.3.2 Simple Password

With this Simple Password configured, clients are required to enter the correct password to pass the authentication.

Follow the steps below to configure No Simple Password Portal:

1. Go to **Wireless Settings > Basic Wireless Settings** and create an SSID for the Portal.
2. Go back to the Portal configuration page. In the **Basic Info** section, complete the basic settings for the portal authentication.

The screenshot shows the 'Basic Info' configuration page for a portal. The fields are as follows:

- Portal Name: [Text input field]
- SSID: [- Please Select -]
- Authentication Type: [Simple Password]
- Password: [Text input field with copy icon]
- Authentication Timeout: [1 Hour]
- HTTPS Redirect: [checked] Enable
- Redirect: [unchecked] Enable
- Redirect URL: [Greyed out text input field]

Configure the following parameters:

Portal Name	Specify a name for the Portal.
SSID	Select an SSID for the Portal.
Authentication Type	Select Simple Password .
Password	Set the password for authentication.

Authentication Timeout	<p>The client's authentication will expire after the time period you set and the client needs to log in again on the web authentication page to access the network.</p> <p>Options include 1 Hour, 8 Hours, 24 Hours, 7 Days and Custom. Custom allows you to define the time in days, hours and minutes. The default value is one hour.</p>
HTTPS Redirect	<p>With this function enabled, the unauthorized clients will be redirected to the Portal page when they are trying to browse HTTPS websites.</p> <p>With this function disabled, the unauthorized clients cannot browse HTTPS websites and are not redirected to the Portal page.</p>
Redirect	<p>If you enable this function, the portal will redirect the newly authenticated clients to the configured URL.</p>
Redirect URL	<p>If the Redirect function above is enabled, enter the URL that a newly authenticated client will be redirected to.</p>

3. In the **Login Page** section, configure the login page for the Portal.

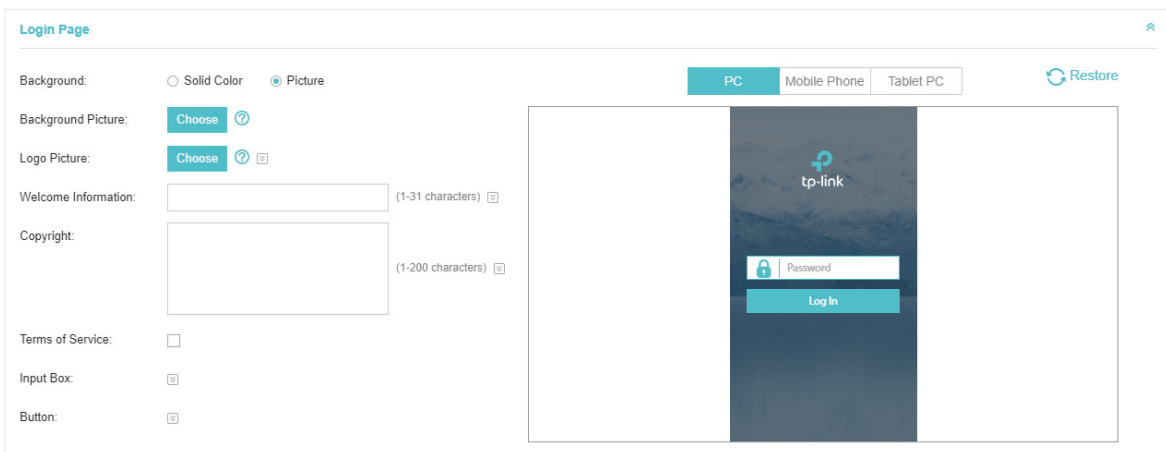

Configure the following parameters:

Background	<p>Select the background type. Two types are supported: Solid Color and Picture.</p>
Background Color	<p>If Solid Color is selected, configure your desired background color through the color picker or by entering the RGB value manually.</p>
Background Picture	<p>If Picture is selected, click the Choose button and select a picture from your PC. Drag and scale the clipping region to edit the picture and click Confirm.</p>

Logo Picture

Click the **Choose** button and select a picture from your PC. Drag and scale the clipping region to edit the picture and click **Confirm**.

In addition, you can click and configure the logo position. The options include **Middle**, **Upper** and **Lower**.

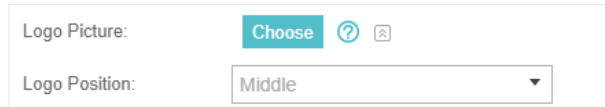

Welcome Information

Specify the welcome information.

In addition, you can click and select your desired text color for the welcome information through the color picker or by entering the RGB value manually.

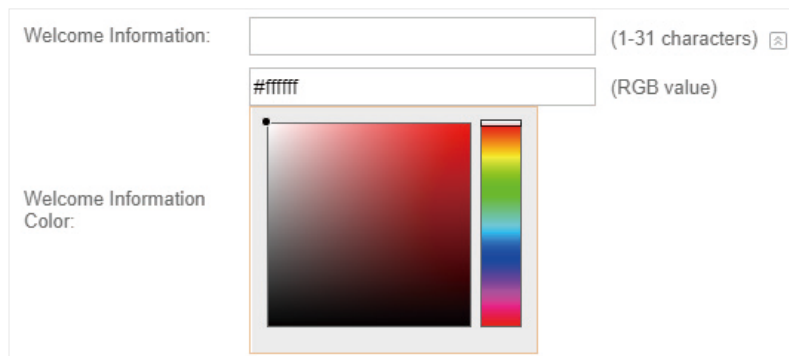

Copyright

Specify the copyright information.

In addition, you can click and select your desired text color for Copyright information through the color picker or by entering the RGB value manually.

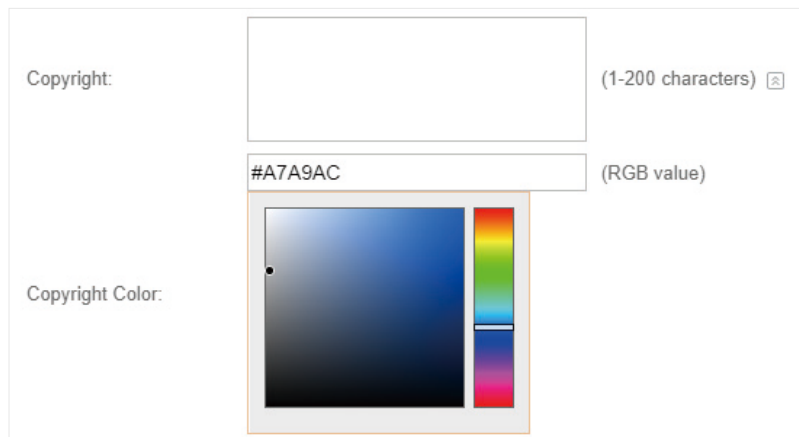

Terms of Service

Enable or disable Terms of Service. With this option enabled, specify the terms of service in the following box.

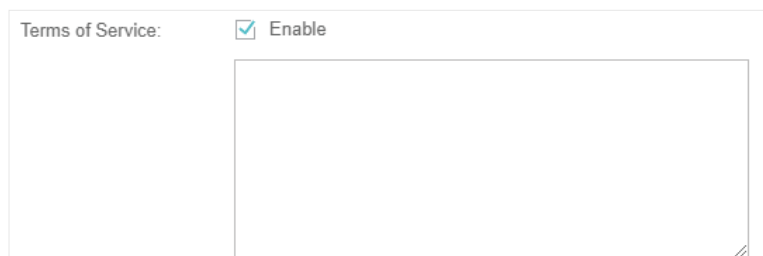

Input Box

Click  and configure the input box.

Select your desired color for the input box through the color picker or by entering the RGB value manually.



Button

Click  and configure the button.

Button Position: Set the position of the login button. The options include **Middle**, **Upper** and **Lower**.

Button Color: Select your desired login button color through the color picker or by entering the RGB value manually.

Button Text Color: Select your desired text color for the button through the color picker or by entering the RGB value manually.

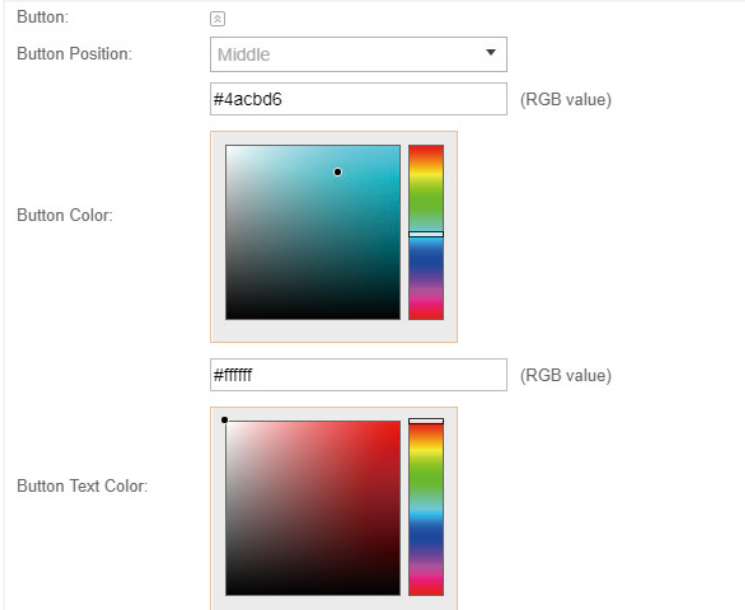

-
4. In the **Advertisement** section, select whether to display advertisement pictures for users and configure the related parameters.

Configure the following parameters:

Advertisement	Specify whether to enable the Advertisement feature. With this feature enabled, you can add advertisement pictures on the authentication page. These advertisement pictures will be displayed before the login page appears. You can also allow users to skip the advertisement by enabling Allow Users To Skip Advertisement . The advertisement picture should be less than 2MB. And only JPG, PNG, BMP, GIF and JPEG file types are supported.
Picture Resource	Upload advertisement pictures. When several pictures are added, they will be played in a loop.
Advertisement Duration Time	Specify how long the advertisement will be displayed for. For this duration, the pictures will be played in a loop. If the duration time is not enough for all the pictures, the rest will not be displayed.
Picture Carousel Interval	Specify the picture carousel interval. For example, if this value is set as 5 seconds, the first picture will be displayed for 5 seconds, followed by the second picture for 5 seconds, and so on.
Allow Users To Skip Advertisement	Specify whether to enable this feature. With this feature enabled, the user can click the Skip button to skip the advertisement.

5. Click **Apply**.

3.3.3 Local User

With this Local User configured, clients are required to enter the correct username and password of the login account to pass the authentication. You can create multiple accounts and assign different accounts for different users.

Configure Local User Portal

Follow the steps below to configure Local User Portal:

1. Go to **Wireless Settings > Basic Wireless Settings** and create an SSID for the Portal.
2. Go back to the Portal configuration page. In the **Basic Info** section, complete the basic settings for the portal authentication.

Basic Info

Portal Name:

SSID:

Authentication Type: [User Management](#)

HTTPS Redirect: Enable [?](#)

Redirect: Enable [?](#)

Redirect URL:

Configure the following parameters:

Portal Name	Specify a name for the Portal.
SSID	Select an SSID for the Portal.
Authentication Type	Select Local User .
User Management	You can click this button to configure user accounts for authentication later. Please refer to Create Local User Accounts .
HTTPS Redirect	With this function enabled, the unauthorized clients will be redirected to the Portal page when they are trying to browse HTTPS websites. With this function disabled, the unauthorized clients cannot browse HTTPS websites and are not redirected to the Portal page.
Redirect	If you enable this function, the portal will redirect the newly authenticated clients to the configured URL.
Redirect URL	If the Redirect function above is enabled, enter the URL that a newly authenticated client will be redirected to.

3. In the **Login Page** section, configure the login page for the Portal.

Login Page

Background: Solid Color Picture

Background Picture: [?](#)

Logo Picture: [?](#)

Welcome Information: (1-31 characters)

Copyright: (1-200 characters)

Terms of Service:

Input Box:





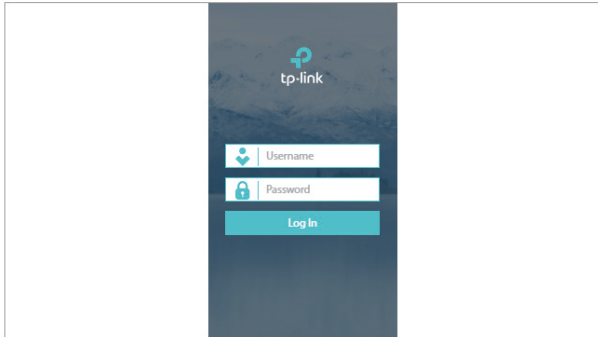

Button:

PC Mobile Phone Tablet PC

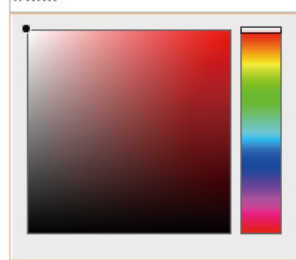

Configure the following parameters:

Background	Select the background type. Two types are supported: Solid Color and Picture .
-------------------	--

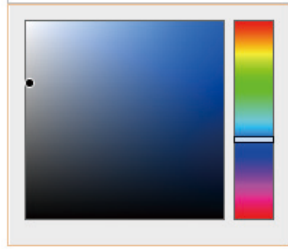
Background Color	If Solid Color is selected, configure your desired background color through the color picker or by entering the RGB value manually.
Background Picture	If Picture is selected, click the Choose button and select a picture from your PC. Drag and scale the clipping region to edit the picture and click Confirm .
Logo Picture	<p>Click the Choose button and select a picture from your PC. Drag and scale the clipping region to edit the picture and click Confirm.</p> <p>In addition, you can click  and configure the logo position. The options include Middle, Upper and Lower.</p> <div data-bbox="606 593 1220 705"> <p>Logo Picture: <input type="button" value="Choose"/>  </p> <p>Logo Position: <input type="text" value="Middle"/></p> </div>
Welcome Information	<p>Specify the welcome information.</p> <p>In addition, you can click  and select your desired text color for the welcome information through the color picker or by entering the RGB value manually.</p> <div data-bbox="606 896 1404 1265"> <p>Welcome Information: <input type="text"/> (1-31 characters) </p> <p>#ffffff (RGB value)</p> <p>Welcome Information Color: </p> </div>
Copyright	<p>Specify the copyright information.</p> <p>In addition, you can click  and select your desired text color for Copyright information through the color picker or by entering the RGB value manually.</p> <div data-bbox="606 1422 1404 1870"> <p>Copyright: <input type="text"/> (1-200 characters) </p> <p>#A7A9AC (RGB value)</p> <p>Copyright Color: </p> </div>

Terms of Service

Enable or disable Terms of Service. With this option enabled, specify the terms of service in the following box.

Terms of Service: Enable

Input Box

Click  and configure the input box.

Select your desired color for the input box through the color picker or by entering the RGB value manually.

Input Box: 

(RGB value)

Input Box Color:

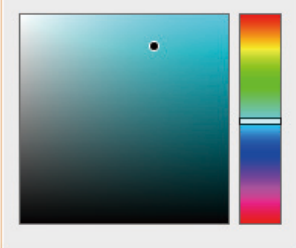

Button

Click  and configure the button.

Button Position: Set the position of the login button. The options include **Middle**, **Upper** and **Lower**.

Button Color: Select your desired login button color through the color picker or by entering the RGB value manually.

Button Text Color: Select your desired text color for the button through the color picker or by entering the RGB value manually.

Button: 

Button Position:

(RGB value)

Button Color:

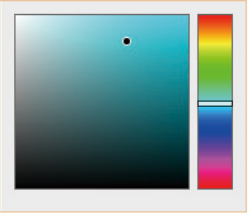

(RGB value)

Button Text Color:

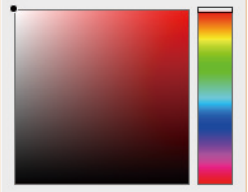

- In the **Advertisement** section, select whether to display advertisement pictures for users and configure the related parameters.

Configure the following parameters:

Advertisement	Specify whether to enable the Advertisement feature. With this feature enabled, you can add advertisement pictures on the authentication page. These advertisement pictures will be displayed before the login page appears. You can also allow users to skip the advertisement by enabling Allow Users To Skip Advertisement . The advertisement picture should be less than 2MB. And only JPG, PNG, BMP, GIF and JPEG file types are supported.
Picture Resource	Upload advertisement pictures. When several pictures are added, they will be played in a loop.
Advertisement Duration Time	Specify how long the advertisement will be displayed for. For this duration, the pictures will be played in a loop. If the duration time is not enough for all the pictures, the rest will not be displayed.
Picture Carousel Interval	Specify the picture carousel interval. For example, if this value is set as 5 seconds, the first picture will be displayed for 5 seconds, followed by the second picture for 5 seconds, and so on.
Allow Users To Skip Advertisement	Specify whether to enable this feature. With this feature enabled, the user can click the Skip button to skip the advertisement.

- Click **Apply**.

Create Local User Accounts

Follow the steps below to create the user accounts for authentication:

- In the **Basic Info** section on the portal configuration page, click **User Management**. The management page will appear. Go to the **User** page and click **Create User**.

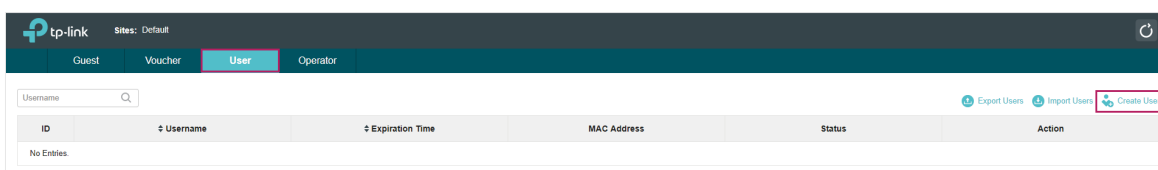

2. The following window will pop up. Configure the required parameters and click **Apply**.

Create New User
✕

Username: (1-100 letters, digits or special characters)

Password: (1-100 letters, digits or special characters)

Authentication Timeout: (Format: YYYY-MM-DD)

MAC Address Binding Type:

Maximum Users: (1-2048)

Name: (1-50 characters, Optional)

Telephone: (1-50 characters, Optional)

Rate Limit (Download): Enable

Rate Limit (Download): Kbps (0-10240000)

Rate Limit (Upload): Enable

Rate Limit (Upload): Kbps (0-10240000)

Traffic Limit: Enable



Traffic Limit: MBytes (1-1048576)

Configure the following parameters:



Username	Specify the username. The username should not be the same as any existing one.
Password	Specify the password. Users will be required to enter the username and password when they attempt to access the network.
Authentication Timeout	Specify the authentication timeout for formal users. After timeout, the users need to log in again on the web authentication page to access the network.
MAC Address Binding Type	<p>There are three types of MAC binding: No Binding, Static Binding and Dynamic Binding.</p> <p>Static Binding: Specify a MAC address for this user account. Then only the user with the this MAC address can use the username and password to pass the authentication.</p> <p>Dynamic Binding: The MAC address of the first user that passes the authentication will be bound. Then only this user can use the username and password to pass the authentication.</p>

Maximum Users	Specify the maximum number of users able to use this account to pass the authentication.
Name	Specify a name for identification.
Telephone	Specify a telephone number for identification.
Rate Limit (Download)	Select whether to enable download rate limit. With this option enabled, you can specify the limit of download rate.
Rate Limit (Upload)	Select whether to enable upload rate limit. With this option enabled, you can specify the limit of upload rate.
Traffic Limit	Select whether to enable traffic limit. With this option enabled, you can specify the total traffic limit for the user. Once the limit is reached, the user can no longer use this account to access the network.

3. In the same way, you can add more user accounts. The created user accounts will be displayed in the list. Users can use the username and password of the account to pass the portal authentication.

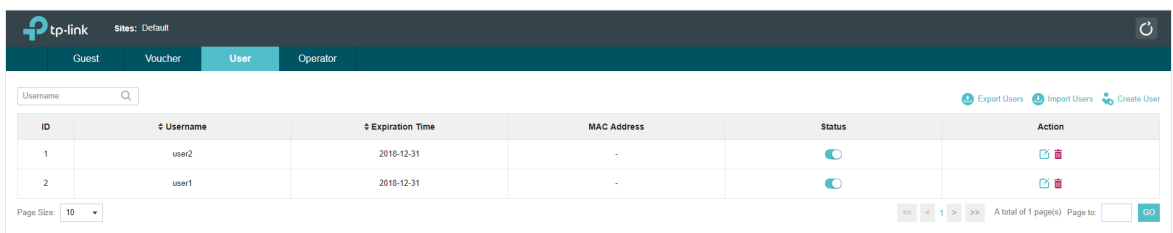
By default, the account Status is , which means that the user account is enabled and valid. You can also click this button to disable the user account. The icon will be changed to , which means that the user account is disabled.



Additionally, you can click  **Export Users** to backup all the user account information into a CSV file or XLS file and save the file to your PC. If needed, you can click  **Import Users** and select the file to import the account information to the list.

Note:

Using Excel to open the CSV file may cause some numerical format changes, and the number may be displayed incorrectly. If you use Excel to edit the CSV file, please set the cell format as text.

Manage the Guests

On the Guest page, you can view the information of clients that have passed the portal authentication and manage the clients.

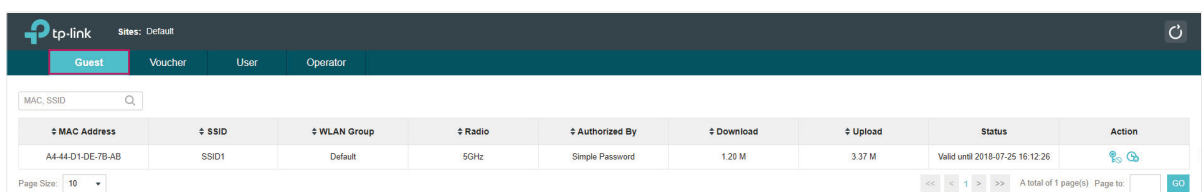

You can select an icon to execute the corresponding operation:



Disconnect client.



Extend the effective time.

Create Operator Accounts

Operator account can be used to remotely manage the Local User Portal and Voucher Portal. Other users can visit the URL **https://Omada Controller Host's IP Address:8043/hotspot** (For example: https://192.168.0.64:8043/hotspot) and use the Operator account to enter the portal management page.

Note:

- Make sure the host that is used to enter the portal management page with operator account can visit the Controller host.
- Only the user that log in to the controller with the administrator role can add or remove the operator account for portal management.
- The users who enter the portal management page by operator account can only create local user accounts and vouchers and manage the clients.

Follow the steps below to create Operator account.

1. Go to the **Operator** page.

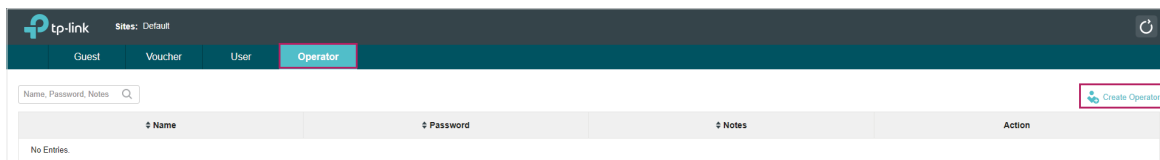

2. Click  **Create Operator** and the following window will pop up.

Create Operator

Name:

Password:

Notes:

Site Privileges:

3. Specify the **Name**, **Password** and **Notes** of the Operator account.
4. Select **Site Privileges** from the drop-down list (multiple options available) for the Operator account.
5. Click **Apply** to create an Operator account. Then other users can use this account to enter the hotspot management page.

3.3.4 Voucher

With Voucher configured, you can distribute the vouchers automatically generated by the Omada Controller to the clients. Clients can use the vouchers to access the network.

Configure Voucher Portal

Follow the steps below to configure Voucher Portal:

1. Go to **Wireless Settings > Basic Wireless Settings** and create an SSID for the Portal.
2. Go back to the Portal configuration page. In the **Basic Info** section, complete the basic settings for the portal authentication.

The screenshot shows the 'Basic Info' configuration page for a Voucher Portal. It contains the following fields and options:



- Portal Name:** An empty text input field.
- SSID:** A dropdown menu with '- Please Select -' as the current selection.
- Authentication Type:** A dropdown menu with 'Voucher' selected. Below it is a link labeled 'Voucher Manager'.
- HTTPS Redirect:** A checkbox labeled 'Enable' which is checked.
- Redirect:** A checkbox labeled 'Enable' which is unchecked.
- Redirect URL:** An empty text input field.

Configure the following parameters:

Portal Name	Specify a name for the Portal.
SSID	Select an SSID for the Portal.
Authentication Type	Select Voucher .
User Management	You can click this button to configure vouchers for authentication later. Please refer to Create Vouchers .
HTTPS Redirect	With this function enabled, the unauthorized clients will be redirected to the Portal page when they are trying to browse HTTPS websites. With this function disabled, the unauthorized clients cannot browse HTTPS websites and are not redirected to the Portal page.
Redirect	If you enable this function, the portal will redirect the newly authenticated clients to the configured URL.
Redirect URL	If the Redirect function above is enabled, enter the URL that a newly authenticated client will be redirected to.

3. In the **Login Page** section, configure the login page for the Portal.

Configure the following parameters:

Background	Select the background type. Two types are supported: Solid Color and Picture .
Background Color	If Solid Color is selected, configure your desired background color through the color picker or by entering the RGB value manually.
Background Picture	If Picture is selected, click the Choose button and select a picture from your PC. Drag and scale the clipping region to edit the picture and click Confirm .
Logo Picture	Click the Choose button and select a picture from your PC. Drag and scale the clipping region to edit the picture and click Confirm . In addition, you can click  and configure the logo position. The options include Middle , Upper and Lower .
Welcome Information	Specify the welcome information. In addition, you can click  and select your desired text color for the welcome information through the color picker or by entering the RGB value manually.

Copyright

Specify the copyright information.

In addition, you can click  and select your desired text color for Copyright information through the color picker or by entering the RGB value manually.

Copyright: (1-200 characters) 

Copyright Color: (RGB value)

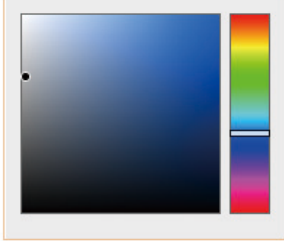

The color picker shows a gradient from black to white with a vertical color bar on the right. A black dot is positioned on the gradient, corresponding to the #A7A9AC color value.

Terms of Service

Enable or disable Terms of Service. With this option enabled, specify the terms of service in the following box.

Terms of Service: Enable

Input Box

Click  and configure the input box.

Select your desired color for the input box through the color picker or by entering the RGB value manually.

Input Box: 

Input Box Color: (RGB value)

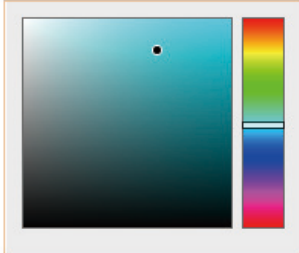

The color picker shows a gradient from black to white with a vertical color bar on the right. A teal dot is positioned on the gradient, corresponding to the #4acbd6 color value.

Button

Click  and configure the button.

Button Position: Set the position of the login button. The options include **Middle**, **Upper** and **Lower**.

Button Color: Select your desired login button color through the color picker or by entering the RGB value manually.

Button Text Color: Select your desired text color for the button through the color picker or by entering the RGB value manually.

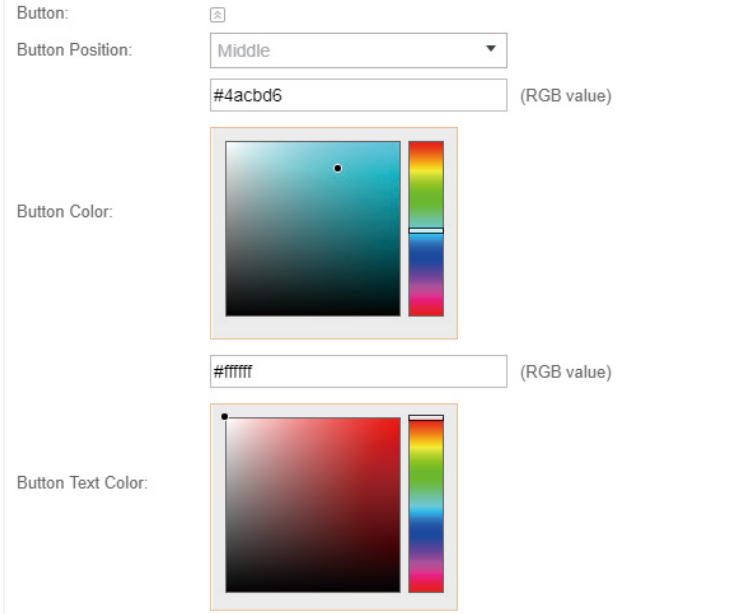

Button: 

Button Position:

(RGB value)

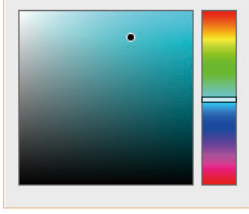
Button Color: 

(RGB value)

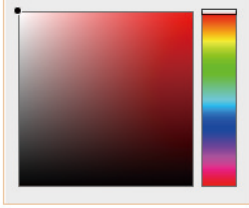
Button Text Color: 

4. In the **Advertisement** section, select whether to display advertisement pictures for users and configure the related parameters.

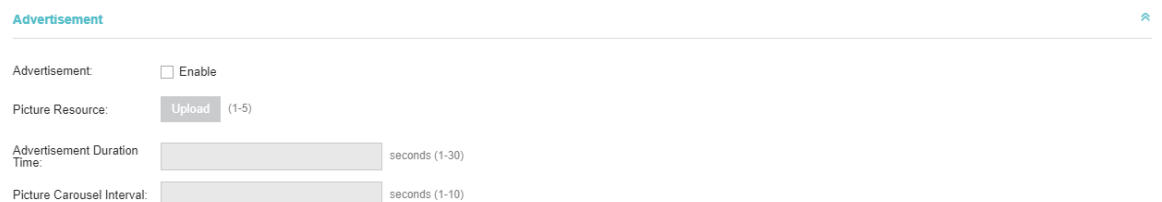

Advertisement 

Advertisement: Enable

Picture Resource: (1-5)

Advertisement Duration Time: seconds (1-30)

Picture Carousel Interval: seconds (1-10)

Configure the following parameters:

Advertisement

Specify whether to enable the Advertisement feature. With this feature enabled, you can add advertisement pictures on the authentication page. These advertisement pictures will be displayed before the login page appears. You can also allow users to skip the advertisement by enabling **Allow Users To Skip Advertisement**. The advertisement picture should be less than 2MB. And only JPG, PNG, BMP, GIF and JPEG file types are supported.

Picture Resource

Upload advertisement pictures. When several pictures are added, they will be played in a loop.

Advertisement Duration Time

Specify how long the advertisement will be displayed for. For this duration, the pictures will be played in a loop. If the duration time is not enough for all the pictures, the rest will not be displayed.

Picture Carousel Interval

Specify the picture carousel interval. For example, if this value is set as 5 seconds, the first picture will be displayed for 5 seconds, followed by the second picture for 5 seconds, and so on.

Allow Users To Skip Advertisement

Specify whether to enable this feature. With this feature enabled, the user can click the **Skip** button to skip the advertisement.

5. Click **Apply**.

Create Vouchers

Follow the steps below to create vouchers for authentication:

1. In the **Basic Info** section, click **Voucher Manager**. The voucher management page will appear. Go to the **Voucher** page and click  **Create Vouchers**.

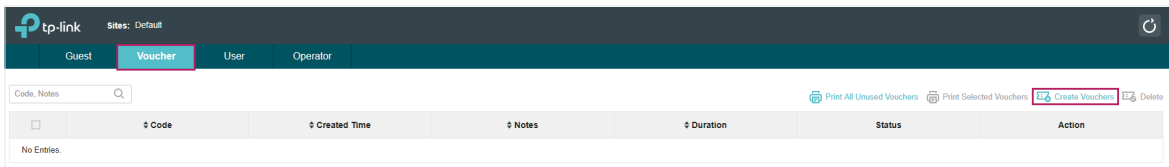

2. The following window will pop up. Configure the required parameters and click **Apply**.

Create Vouchers

Code Length: (6-10)

Amount: (1-500)

Type:

Duration:

Rate Limit (Download): Enable

Rate Limit (Download): Kbps (0-10240000)

Rate Limit (Upload): Enable

Rate Limit (Upload): Kbps (0-10240000)

Traffic Limit: Enable

Traffic Limit: MBytes (1-1048576)

Note: (Optional)

Configure the following parameters:

Code Length	Specify the length of the voucher codes to be created.
Amount	Enter the voucher amount to be generated.
Type	<p>Select Single Use or Multi Use.</p> <p>Single Use means one voucher can only be distributed to one client. Multi Use means one voucher can be distributed to several clients, who can use the same voucher to access the network at the same time.</p> <p>If you select Multi Use, enter the value of Max Users. When the number of clients who are connected to the network with the same voucher reaches the value, no more clients can use this voucher to access the network.</p>
Duration	<p>Select the period of validity of the Voucher.</p> <p>The options include 8 hours, 2 days and User-defined. The period of valid of the voucher is reckoned from the time when it is used for the first time.</p>
Rate Limit (Download)	Select whether to enable download rate limit. With this option enabled, you can specify the limit of download rate.
Rate Limit (Upload)	Select whether to enable upload rate limit. With this option enabled, you can specify the limit of upload rate.
Traffic Limit	Specify the total traffic limit for one voucher. Once the limit is reached, the client can no longer access the network using the voucher.
Notes	Enter a description for the Voucher (optional).

3. The Vouchers will be generated and displayed on the page.

The screenshot shows the TP-Link Voucher management interface. At the top, there are navigation tabs for Guest, Voucher, User, and Operator. Below the tabs, there are action buttons: Print All Unused Vouchers, Print Selected Vouchers, Create Vouchers, and Delete. The main area contains a table with the following columns: Code, Created Time, Notes, Duration, Status, and Action. The table lists 12 vouchers, all with a duration of 8h 0m 0s and a status of 'Valid for single use'. The Action column contains icons for deleting and printing each voucher. At the bottom, there is a page size selector set to 10 and a pagination control showing 'A total of 1 page(s) Page to: GO'.

<input type="checkbox"/>	Code	Created Time	Notes	Duration	Status	Action
<input type="checkbox"/>	838770	2018-07-25 15:49:30		8h 0m 0s	Valid for single use	
<input type="checkbox"/>	202209	2018-07-25 15:49:30		8h 0m 0s	Valid for single use	
<input type="checkbox"/>	306697	2018-07-25 15:49:30		8h 0m 0s	Valid for single use	
<input type="checkbox"/>	568081	2018-07-25 15:49:30		8h 0m 0s	Valid for single use	
<input type="checkbox"/>	637139	2018-07-25 15:49:30		8h 0m 0s	Valid for single use	
<input type="checkbox"/>	461670	2018-07-25 15:49:30		8h 0m 0s	Valid for single use	
<input type="checkbox"/>	172787	2018-07-25 15:49:30		8h 0m 0s	Valid for single use	
<input type="checkbox"/>	457410	2018-07-25 15:49:30		8h 0m 0s	Valid for single use	
<input type="checkbox"/>	191851	2018-07-25 15:49:30		8h 0m 0s	Valid for single use	
<input type="checkbox"/>	921414	2018-07-25 15:49:30		8h 0m 0s	Valid for single use	

4. Click to print a single voucher; click Print Selected Vouchers to print your selected vouchers; click Print All Unused Vouchers to print all unused vouchers.

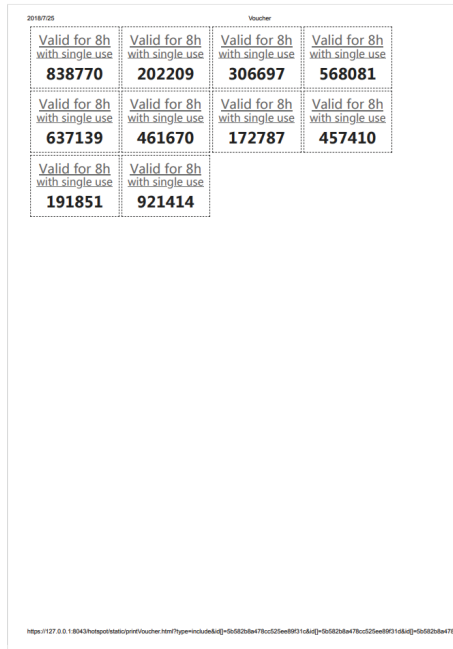

5. Distribute the vouchers to clients, and then they can use the codes to pass authentication.

6. When the vouchers are invalid, you can click  to delete the Voucher or click  Delete to delete the selected vouchers.

Manage the Guests

On the Guest page, you can view the information of clients that have passed the portal authentication and manage the clients.

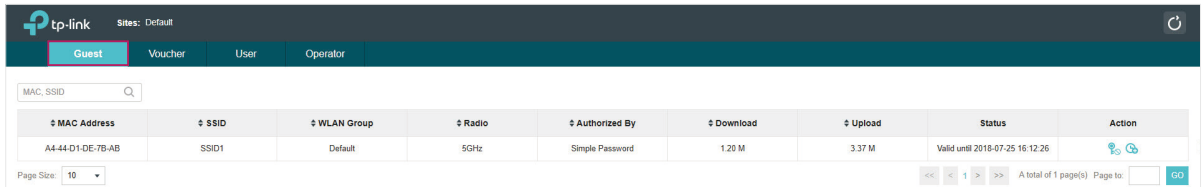

You can select an icon to execute the corresponding operation:



Restrict the client to access the network.



Extend the effective time.

Create Operator Accounts

Operator account can be used to remotely manage the Local User Portal and Voucher Portal. Other users can visit the URL **https://Omda Controller Host's IP Address:8043/hotspot** (For example: **https://192.168.0.64:8043/hotspot**) and use the Operator account to enter the portal management page.

Note:

- Make sure the host that is used to enter the portal management page with operator account can visit the Controller host.
- Only the user that log in to the controller with the administrator role can add or remove the operator account for portal management.
- The users who enter the portal management page by operator account can only create local user accounts and vouchers and manage the clients.

Follow the steps below to create Operator account.

1. Go to the **Operator** page.

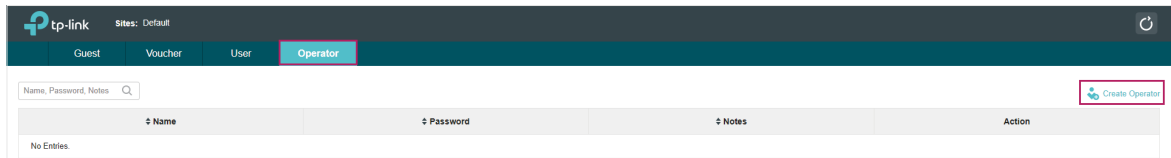

2. Click  **Create Operator** and the following window will pop up.

A dialog box titled 'Create Operator' with a close button in the top right corner. It contains four input fields: 'Name' with the value 'Operator-1', 'Password' with masked characters '*****' and an eye icon, 'Notes' with the value 'The chief', and 'Site Privileges' with a dropdown menu showing 'Office A'. An 'Apply' button is located at the bottom left of the dialog.

3. Specify the **Name**, **Password** and **Notes** of the Operator account.
4. Select **Site Privileges** from the drop-down list (multiple options available) for the Operator account.
5. Click **Apply** to create an Operator account. Then other users can use this account to enter the hotspot administrative system.

3.3.5 SMS

With SMS portal configured, client can get verification codes using their mobile phones and enter the received codes to pass the authentication.

Follow the steps below to configure SMS Portal:

1. Go to www.twilio.com/try-twilio and get a Twilio account. Buy the Twilio service for SMS. Then get the account information, including ACCOUNT SID, AUTH TOKEN and Phone number.
2. Go to **Wireless Settings > Basic Wireless Settings** and create an SSID for the Portal.
3. Go back to the Portal configuration page. In the **Basic Info** section, complete the basic settings for the portal authentication.

Basic Info ↑

Portal Name:

SSID:

Authentication Type:

We provide Twilio API service. Please configure your account information:

Twilio SID:

Auth Token:

Phone Number: (E.g., +17704505791)

Maximum User: (0-10, 0 means no limit)

Preset Country Code: (E.g., +1, optional)

Authentication Timeout:

HTTPS Redirect: Enable [?](#)

Redirect: Enable [?](#)

Redirect URL:

Configure the following parameters:

Portal Name	Specify a name for the Portal.
SSID	Select an SSID for the Portal.
Authentication Type	Select SMS .
Twilio SID	Enter the Account SID for Twilio API Credentials.
Auth Token	Enter the Authentication Token for Twilio API Credentials.
Phone Number	Enter the phone number that is used to send verification messages to the clients.
Maximum Users	<p>A telephone can get several codes via messages one by one, and different clients can use different codes to pass the authentication. However, the number of clients that is allowed to be authenticated using the same telephone at the same time has a upper limit.</p> <p>Specify the upper limit in this field.</p>
Authentication Timeout	<p>The client's authentication will expire after the time period you set and the client needs to log in again on the web authentication page to access the network.</p> <p>Options include 1 Hour, 8 Hours, 24 Hours, 7 Days and Custom. Custom allows you to define the time in days, hours and minutes. The default value is one hour.</p>
Preset Country Code	Set the default country code that will be filled automatically on the authentication page.
HTTPS Redirect	<p>With this function enabled, the unauthorized clients will be redirected to the Portal page when they are trying to browse HTTPS websites.</p> <p>With this function disabled, the unauthorized clients cannot browse HTTPS websites and are not redirected to the Portal page.</p>

Redirect	If you enable this function, the portal will redirect the newly authenticated clients to the configured URL.
Redirect URL	If the Redirect function above is enabled, enter the URL that a newly authenticated client will be redirected to.

4. In the **Login Page** section, configure the login page for the Portal.

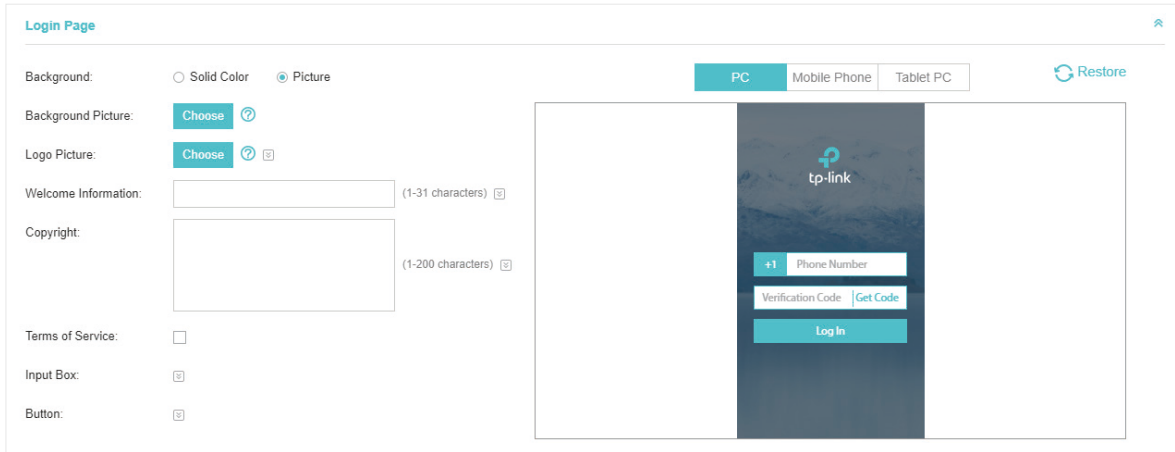

Configure the following parameters:

Background	Select the background type. Two types are supported: Solid Color and Picture .
Background Color	If Solid Color is selected, configure your desired background color through the color picker or by entering the RGB value manually.
Background Picture	If Picture is selected, click the Choose button and select a picture from your PC. Drag and scale the clipping region to edit the picture and click Confirm .
Logo Picture	Click the Choose button and select a picture from your PC. Drag and scale the clipping region to edit the picture and click Confirm . In addition, you can click <input type="checkbox"/> and configure the logo position. The options include Middle , Upper and Lower .

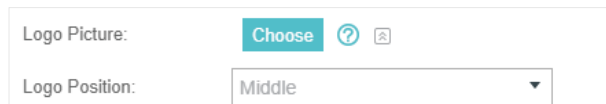

Welcome Information

Specify the welcome information.

In addition, you can click  and select your desired text color for the welcome information through the color picker or by entering the RGB value manually.

Welcome Information:	<input type="text"/>	(1-31 characters) 
	<input type="text" value="#ffffff"/>	(RGB value)
Welcome Information Color:		

Copyright

Specify the copyright information.

In addition, you can click  and select your desired text color for Copyright information through the color picker or by entering the RGB value manually.

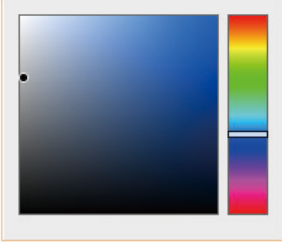
Copyright:	<input type="text"/>	(1-200 characters) 
	<input type="text" value="#A7A9AC"/>	(RGB value)
Copyright Color:		

Terms of Service

Enable or disable Terms of Service. With this option enabled, specify the terms of service in the following box.

Terms of Service:	<input checked="" type="checkbox"/> Enable
<div style="border: 1px solid #ccc; height: 80px; width: 100%;"></div>	

Input Box

Click  and configure the input box.

Select your desired color for the input box through the color picker or by entering the RGB value manually.

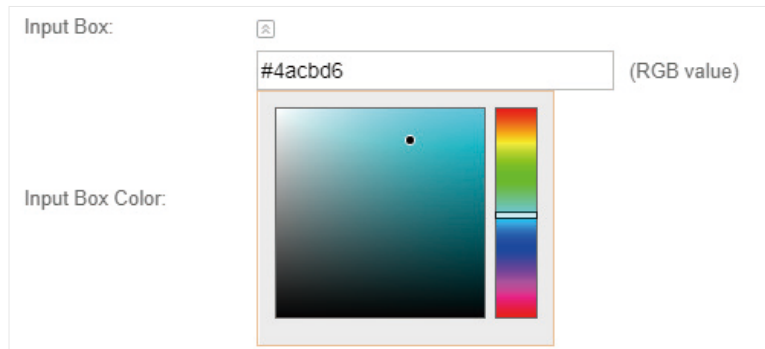

Button

Click  and configure the button.

Button Position: Set the position of the login button. The options include **Middle**, **Upper** and **Lower**.

Button Color: Select your desired login button color through the color picker or by entering the RGB value manually.

Button Text Color: Select your desired text color for the button through the color picker or by entering the RGB value manually.

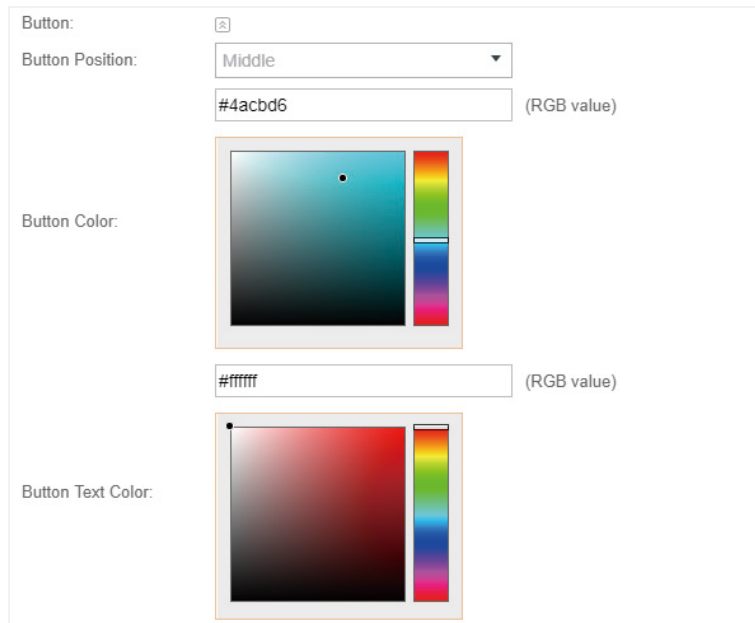

5. In the **Advertisement** section, select whether to display advertisement pictures for users and configure the related parameters.

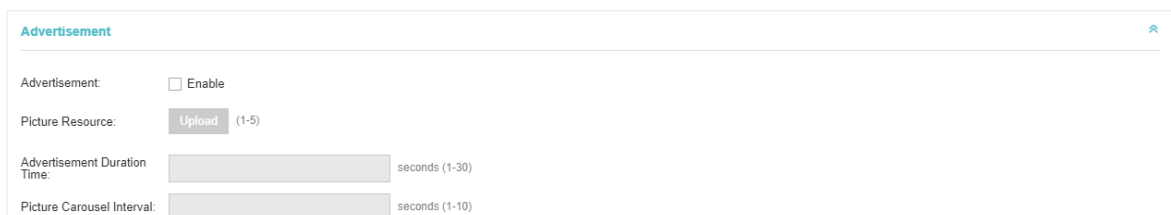

Configure the following parameters:

Advertisement	Specify whether to enable the Advertisement feature. With this feature enabled, you can add advertisement pictures on the authentication page. These advertisement pictures will be displayed before the login page appears. You can also allow users to skip the advertisement by enabling Allow Users To Skip Advertisement . The advertisement picture should be less than 2MB. And only JPG, PNG, BMP, GIF and JPEG file types are supported.
Picture Resource	Upload advertisement pictures. When several pictures are added, they will be played in a loop.
Advertisement Duration Time	Specify how long the advertisement will be displayed for. For this duration, the pictures will be played in a loop. If the duration time is not enough for all the pictures, the rest will not be displayed.
Picture Carousel Interval	Specify the picture carousel interval. For example, if this value is set as 5 seconds, the first picture will be displayed for 5 seconds, followed by the second picture for 5 seconds, and so on.
Allow Users To Skip Advertisement	Specify whether to enable this feature. With this feature enabled, the user can click the Skip button to skip the advertisement.

6. Click **Apply**.

For more details about how to configure SMS Portal, you can go to <https://www.tp-link.com/en/configuration-guides.html> and download the configuration guide for SMS Portal.

3.3.6 Facebook

With Facebook Portal configured, when clients connect to your Wi-Fi, they will be redirected to your Facebook page. To access the internet, clients need to pass the authentication on the page.

Note:

Omada Controller will automatically create Free Authentication Policy entries for the Facebook Portal. You don't need to create them manually.

Follow the steps below to configure Facebook Portal:

1. Go to www.facebook.com and get a Facebook account. Create your Facebook page according to your needs.
2. Go to **Wireless Settings > Basic Wireless Settings** and create an SSID for the Portal.
3. Go back to the Portal configuration page. In the **Basic Info** section, complete the settings for the portal authentication.

Basic Info ⤴

Portal Name:

SSID:

Authentication Type:

Facebook Page Configuration:

Facebook Checkin Location:

HTTPS Redirect: Enable ?

Configure the following parameters:

Portal Name	Specify a name for the Portal.
SSID	Select an SSID for the Portal.
Authentication Type	Select Facebook .
Facebook Page Configuration	Click this button to specify the Facebook Page.
Facebook Checkin Location	If the Facebook page is successfully got by the Omada Controller, the name of the Facebook page will be displayed here.
HTTPS Redirect	<p>With this function enabled, the unauthorized clients will be redirected to the Portal page when they are trying to browse HTTPS websites.</p> <p>With this function disabled, the unauthorized clients cannot browse HTTPS websites and are not redirected to the Portal page.</p>

For more details about how to configure Facebook Portal, you can go to <https://www.tp-link.com/en/configuration-guides.html> and download the configuration guide for Facebook Portal.

3.3.7 External RADIUS Server

If you have a RADIUS server, you can configure External RADIUS Server Portal. With this type of portal, you can get two types of portal customization: Local Web Portal and External Web Portal. The authentication login page of Local Web Portal is provided by the built-in portal server of the controller. The External Web Portal is provided by external portal server.

Note:

Omada Controller will automatically create Free Authentication Policy entries for the External RADIUS Portal.

Follow the steps below to configure External RADIUS Server Portal:

1. Go to **Wireless Settings > Basic Wireless Settings** and create an SSID for the Portal.
2. Go back to the Portal configuration page. In the **Basic Info** section, complete the basic settings for the portal authentication.

Basic Info ⌵

Portal Name:

SSID:

Authentication Type:

Authentication Timeout:

RADIUS Server IP:

RADIUS Port: (1-65535)

RADIUS Password:

Authentication Mode:

NAS ID:

RADIUS Accounting: Enable

Accounting Server IP:

Accounting Server Port: (1-65535)

Accounting Server Password:

Interim Update: Enable

Interim Update Interval: (s, 60-86400)

Portal Customization:

HTTPS Redirect: Enable

Redirect: Enable

Redirect URL:

Configure the following parameters:



Portal Name	Specify a name for the Portal.
SSID	Select an SSID for the Portal.
Authentication Type	Select External RADIUS Server .
Authentication Timeout	<p>The client's authentication will expire after the time period you set and the client needs to log in again on the web authentication page to access the network.</p> <p>Options include 1 Hour, 8 Hours, 24 Hours, 7 Days, Custom. Custom allows you to define the time in days, hours, and minutes. The default value is one hour.</p>
RADIUS Server IP	Enter the IP address of the RADIUS server.
RADIUS Port	Enter the port number you have set on the RADIUS server.
RADIUS Password	Enter the password you have set on the RADIUS server.
Authentication Mode	Select the authentication protocol for the RADIUS server. Two authentication protocols are available: PAP and CHAP .

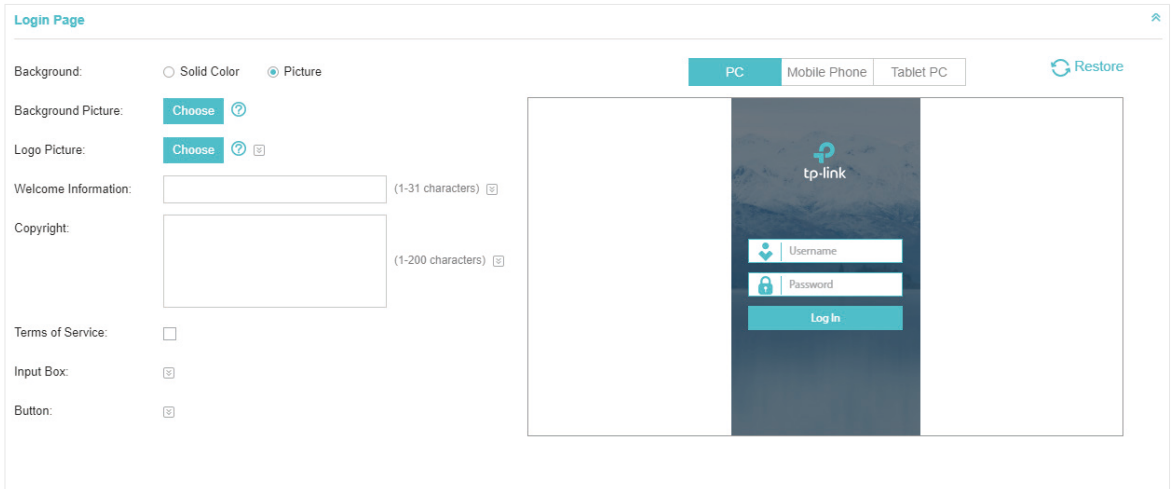

NAS ID	Configure a Network Access Server Identifier (NAS ID) using 1 to 64 characters on the portal. The NAS ID is sent to the RADIUS server by the controller through an authentication request packet. With the NAS ID which classifies users to different groups, the RADIUS server can send a customized authentication response. The default value is TP-Link .
RADIUS Accounting	Enable or disable RADIUS Accounting feature.
Accounting Server IP	Enter the IP address of the accounting server.
Accounting Server Port	Enter the port number of the accounting server. The default port number is 1813.
Accounting Server Password	Enter the shared secret key of the accounting server.
Interim Update	With this option enabled, you can specify the duration between accounting information updates. By default, the function is disabled. Enter the appropriate duration between updates for EAPs in Interim Update Interval .
Interim Update Interval	With Interim Update enabled, specify the appropriate duration between updates for EAPs. The default duration is 600 seconds.
Portal Customization	Select Local Web Portal or External Web Portal. Local Web Portal: If this option is selected, refer to step 3 to configure the login page and step 4 to configure the advertisement. External Web Portal: If this option is selected, follow the steps below. 1. Configure the external RADIUS server. 2. Enter the authentication login page's URL provided by the external portal server in the External Web Portal URL field. Note that you should update the External Web Portal after you upgrade your controller with old version to version 3.1.4 or above. Otherwise, the External Web Portal will not take effect.
HTTPS Redirect	With this function enabled, the unauthorized clients will be redirected to the Portal page when they are trying to browse HTTPS websites. With this function disabled, the unauthorized clients cannot browse HTTPS websites and are not redirected to the Portal page.
Redirect	If you enable this function, the portal will redirect the newly authenticated clients to the configured URL. It is disabled by default.
Redirect URL	If the Redirect function above is enabled, enter the URL that a newly authenticated client will be redirected to.

3. **Local Web Portal** is configured, configure the login page for the Portal in the **Login Page** section.



Configure the following parameters:

Background	Select the background type. Two types are supported: Solid Color and Picture .
Background Color	If Solid Color is selected, configure your desired background color through the color picker or by entering the RGB value manually.
Background Picture	If Picture is selected, click the Choose button and select a picture from your PC. Drag and scale the clipping region to edit the picture and click Confirm .
Logo Picture	Click the Choose button and select a picture from your PC. Drag and scale the clipping region to edit the picture and click Confirm . In addition, you can click  and configure the logo position. The options include Middle , Upper and Lower .
Welcome Information	Specify the welcome information. In addition, you can click  and select your desired text color for the welcome information through the color picker or by entering the RGB value manually.

Logo Picture:  

Logo Position:

Welcome Information: (1-31 characters) 

#ffffff (RGB value)

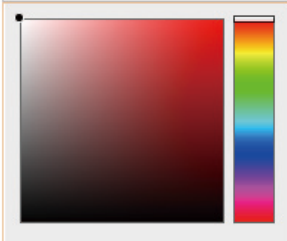
Welcome Information Color: 

Copyright

Specify the copyright information.

In addition, you can click  and select your desired text color for Copyright information through the color picker or by entering the RGB value manually.

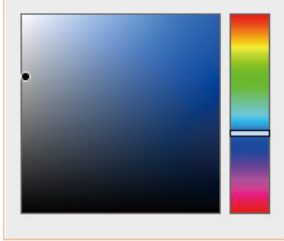
Copyright:	<input type="text"/>	(1-200 characters) 
Copyright Color:	<input type="text" value="#A7A9AC"/>	(RGB value)
		

Terms of Service

Enable or disable Terms of Service. With this option enabled, specify the terms of service in the following box.

Terms of Service:	<input checked="" type="checkbox"/> Enable
	<div style="border: 1px solid #ccc; height: 80px; width: 100%;"></div>

Input Box

Click  and configure the input box.

Select your desired color for the input box through the color picker or by entering the RGB value manually.

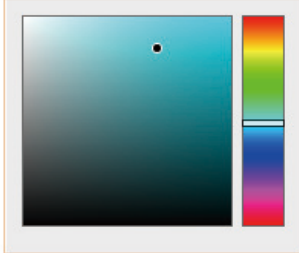
Input Box:	<input type="text"/>	(RGB value)
Input Box Color:	<input type="text" value="#4acbd6"/>	(RGB value)
		

Button

Click  and configure the button.

Button Position: Set the position of the login button. The options include **Middle**, **Upper** and **Lower**.

Button Color: Select your desired login button color through the color picker or by entering the RGB value manually.

Button Text Color: Select your desired text color for the button through the color picker or by entering the RGB value manually.

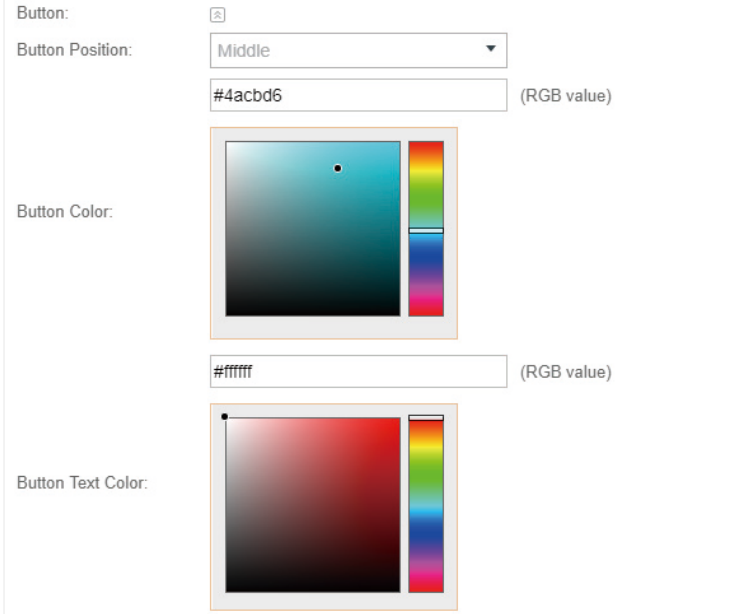

Button: 

Button Position: Middle

#4acbd6 (RGB value)

Button Color:

#ffffff (RGB value)

Button Text Color:

4. If **Local Web Portal** is configured, select whether to display advertisement pictures for users and configure the related parameters in the **Advertisement** section, .

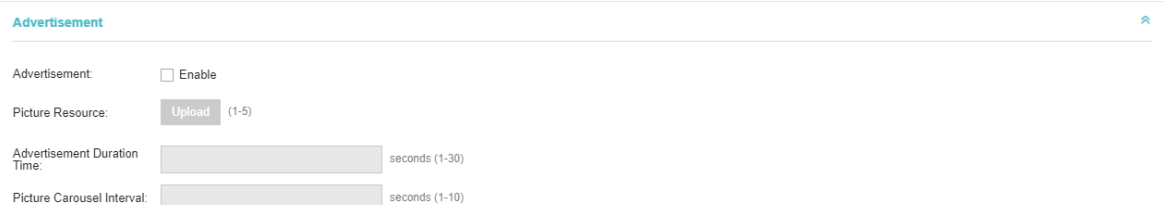

Advertisement

Advertisement: Enable

Picture Resource: (1-5)

Advertisement Duration Time: seconds (1-30)

Picture Carousel Interval: seconds (1-10)

Configure the following parameters:

Advertisement

Specify whether to enable the Advertisement feature. With this feature enabled, you can add advertisement pictures on the authentication page. These advertisement pictures will be displayed before the login page appears. You can also allow users to skip the advertisement by enabling **Allow Users To Skip Advertisement**. The advertisement picture should be less than 2MB. And only JPG, PNG, BMP, GIF and JPEG file types are supported.

Picture Resource

Upload advertisement pictures. When several pictures are added, they will be played in a loop.

Advertisement Duration Time

Specify how long the advertisement will be displayed for. For this duration, the pictures will be played in a loop. If the duration time is not enough for all the pictures, the rest will not be displayed.

Picture Carousel Interval	Specify the picture carousel interval. For example, if this value is set as 5 seconds, the first picture will be displayed for 5 seconds, followed by the second picture for 5 seconds, and so on.
Allow Users To Skip Advertisement	Specify whether to enable this feature. With this feature enabled, the user can click the Skip button to skip the advertisement.

5. Click **Apply**.

3.3.8 External Portal Server

The option of External Portal Server is designed for the developers. They can customized their own authentication type according to the interface provided by Omada Controller, e.g. message authentication and WeChat authentication etc.

1. Go to **Wireless Settings > Basic Wireless Settings** and create an SSID for the Portal.
2. Go back to the Portal configuration page. In the **Basic Info** section, complete the settings for the portal authentication.

The screenshot shows the 'Basic Info' configuration section. It contains the following fields and settings:

- Portal Name:** An empty text input field.
- SSID:** A dropdown menu with the text '- Please Select -'.
- Authentication Type:** A dropdown menu with 'External Portal Server' selected.
- External Portal Server:** An empty text input field.
- HTTPS Redirect:** A checkbox labeled 'Enable' which is checked.
- Apply:** A teal button at the bottom left.

Portal Name	Specify a name for the Portal.
SSID	Select an SSID for the Portal.
Authentication Type	Select External Portal Server .
External Portal Server	Enter the complete authentication URL that redirect to an external portal server, for example: http://192.168.0.147:8880/portal/index.php or http://192.168.0.147/portal/index.html
HTTPS Redirect	With this function enabled, the unauthorized clients will be redirected to the Portal page when they are trying to browse HTTPS websites. With this function disabled, the unauthorized clients cannot browse HTTPS websites and are not redirected to the Portal page.

3. Click **Apply**.

3.4 Free Authentication Policy

Free Authentication Policy allows some specified clients to access the network resources without authentication. Follow the steps below to add free authentication policy.

1. Go to **Wireless Control > Free Authentication Policy**.

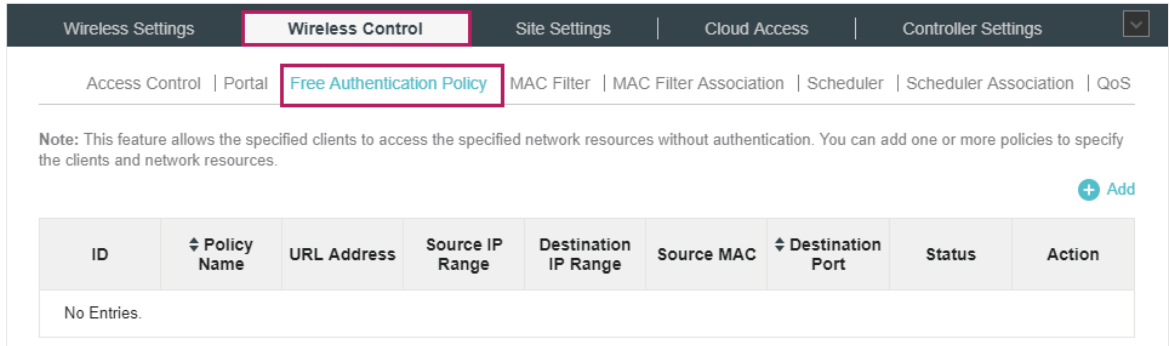

The screenshot shows the 'Free Authentication Policy' configuration page. At the top, there are navigation tabs: 'Wireless Settings', 'Wireless Control' (highlighted), 'Site Settings', 'Cloud Access', and 'Controller Settings'. Below these are sub-tabs: 'Access Control', 'Portal', 'Free Authentication Policy' (highlighted), 'MAC Filter', 'MAC Filter Association', 'Scheduler', 'Scheduler Association', and 'QoS'. A note states: 'Note: This feature allows the specified clients to access the specified network resources without authentication. You can add one or more policies to specify the clients and network resources.' To the right of the note is a '+ Add' button. Below the note is a table with the following columns: ID, Policy Name, URL Address, Source IP Range, Destination IP Range, Source MAC, Destination Port, Status, and Action. The table currently contains 'No Entries'.

2. Click **+ Add** and the following window will pop up.

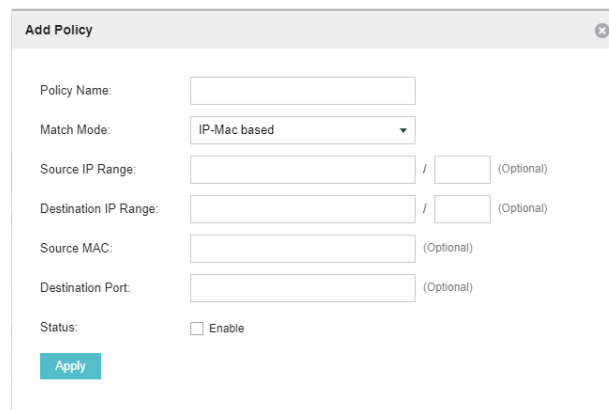

The 'Add Policy' dialog box contains the following fields and options:

- Policy Name:
- Match Mode:
- Source IP Range: / (Optional)
- Destination IP Range: / (Optional)
- Source MAC: (Optional)
- Destination Port: (Optional)
- Status: Enable
- Apply button

3. Configure the following parameters. When all conditions are met, the client can access the network without authentication.

Policy Name	Specify a name for the policy.
Match Mode	Select the match mode for the policy. Two options are provided: URL: With this option selected, configure an URL that is allowed to be visited by the clients without authentication. IP-MAC Based: With this option selected, configure Source IP Range, Destination IP Range, Source MAC and Destination MAC to specify the specific clients and service that will follow the Free Authentication feature.
URL	Set the URL.
Source IP Range	Set the Source IP Range with the subnet and mask length of the clients.
Destination IP Range	Set the Destination IP Range with the subnet and mask length of the server.
Source MAC	Set the MAC address of client.
Destination Port	Enter the port the service uses.
Status	Check the box to enable the policy.

4. Click **Apply** and the policy is successfully added.

3.5 MAC Filter

MAC filter can be used to allow or block the listed clients to access the network. Thereby it can effectively control the client's access to the wireless network.

Follow the steps below to configure MAC Filter.

1. Go to **Wireless Control > MAC Filter** to add MAC Filter group and group members.

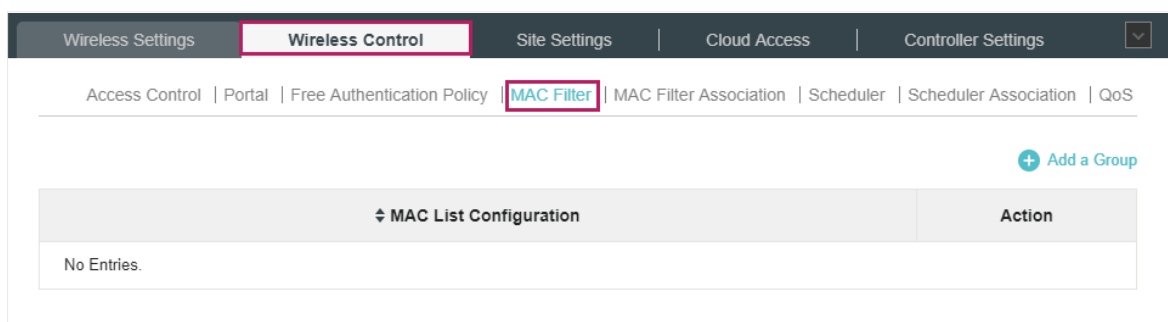

1) Click **+ Add a Group** and specify a name for the group.

2) Click **Apply** and the group will be successfully added as shown below.

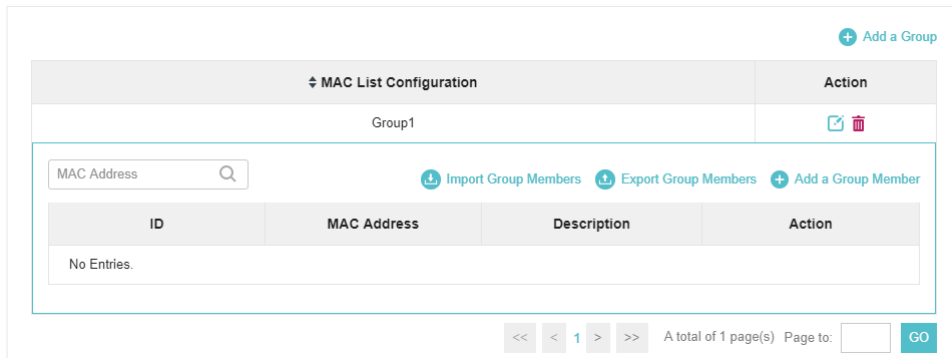

3) Click **+ Add a Group Member** and enter a MAC address in the format as shown below.

The screenshot shows the 'Add a Group Member' dialog box. It has a close button (X) in the top right corner. There are two input fields: 'MAC Address' with the value 'AA-BB-CC-DD-EE-FF' and 'Description' with the value 'User 1'. Below the input fields is an 'Apply' button.

4) Click **Apply** to add the MAC address into the MAC filter group.

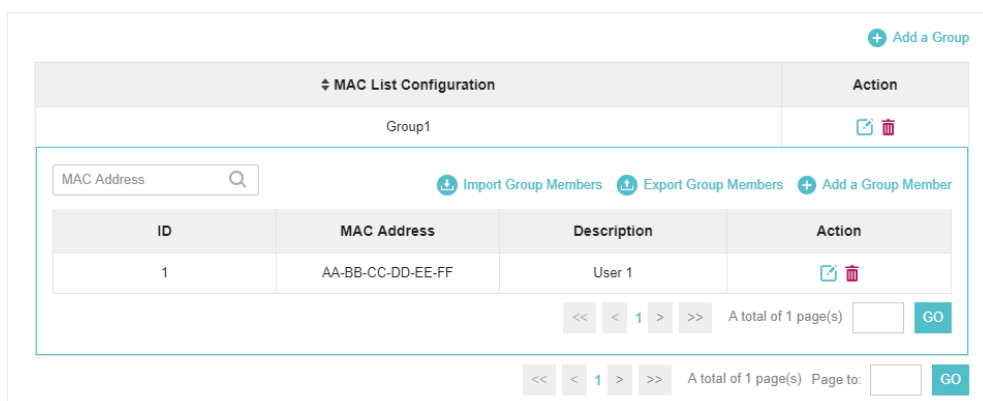

2. You can add more groups or members according to your need.

Note:

You can click **Import Group Members** to export the group members to a excel file and save the file on your PC. If needed, you can also click **Export Group Members** to import the group members to the Omada Controller.

3. Go to **Wireless Control > MAC Filter Association** to associate the added MAC Filter group with SSID.

Wireless Settings | **Wireless Control** | Site Settings | Cloud Access | Controller Settings

Access Control | Portal | Free Authentication Policy | MAC Filter | **MAC Filter Association** | Scheduler | Scheduler Association | QoS

MAC Filtering: Enable

Apply

2.4GHz | 5GHz | Default

ID	SSID Name	Band	MAC Filter Name	Action	Setting
1	SSID1	2.4GHz	Group1	Allow	Apply

<< < 1 > >> A total of 1 page(s) Page to: **GO**

- 1) Check the box and click **Apply** to enable MAC Filtering function.
- 2) Select a band frequency (2.4GHz or 5GHz) and a WLAN group.
- 3) In the MAC Filter Name column of the specified SSID, select a MAC Filter group in the drop-down list. Then select **Allow/Deny** in the Action column to allow/deny the clients in the MAC Filter group to access the network.
- 4) Click **Apply** in the Setting column.

3.6 Scheduler

With the Scheduler, the EAPs or its' wireless network can automatically turn on or off at the time you set. For example, you can use this feature to schedule the radio to operate only during the office working time in order to achieve security goals and reduce power consumption. You can also use the Scheduler to make clients can only access the wireless network during the time period you set in the day.

Follow the steps below to configure Scheduler.

1. Go to **Wireless Control > Scheduler**.

Wireless Settings | **Wireless Control** | Site Settings | Cloud Access | Controller Settings

Access Control | Portal | Free Authentication Policy | MAC Filter | MAC Filter Association | **Scheduler** | Scheduler Association | QoS

+ Add a Profile

Profile Configuration	Action
No Entries.	

- 1) Click **+ Add a Profile** and specify a name for the profile.

Add a Profile ✕

Profile Name:

[Apply](#)

2) Click **Apply** and the profile will be added.

[Wireless Settings](#) | **[Wireless Control](#)** | [Site Settings](#) | [Cloud Access](#) | [Controller Settings](#)

[Access Control](#) | [Portal](#) | [Free Authentication Policy](#) | [MAC Filter](#) | [MAC Filter Association](#) | [Scheduler](#) | [Scheduler Association](#) | [QoS](#)

[+ Add a Profile](#)

Profile Configuration					Action
Profile 1					+ -

[+ Add an Item](#)

ID	Day of Week	Start Time	End Time	Action
No Entries.				

<< < 1 > >> A total of 1 page(s) Page to: [GO](#)

3) Click [+ Add an Item](#) and configure the parameters to specify a period of time.

Add an Item ✕

Day Mode: Weekday Weekend Everyday Custom

Mon Tue Wed Thu Fri Sat Sun

Time: all day-24 hours

Start Time: :

End Time: :

[Apply](#)

4) Click **Apply** and the profile is successfully added in the list.

2. Go to **Wireless Control > Scheduler Association**.

[Wireless Settings](#) | **[Wireless Control](#)** | [Site Settings](#) | [Cloud Access](#) | [Controller Settings](#)

[Access Control](#) | [Portal](#) | [Free Authentication Policy](#) | [MAC Filter](#) | [MAC Filter Association](#) | [Scheduler](#) | **[Scheduler Association](#)** | [QoS](#)

Scheduler: Enable

Association Mode:

[Apply](#)

2.4GHz 5GHz

ID	SSID Name	Band	Profile Name	Action	Setting
1	SSID1	2.4GHz	<input type="text" value="None"/>	<input type="text" value="Radio Off"/>	Apply

<< < 1 > >> A total of 1 page(s) Page to: [GO](#)

- 1) Check the box to enable Scheduler function.
- 2) Select **Associated with SSID** (the profile will be applied to the specific SSID on all the EAPs) or **Associated with AP** (the profile will be applied to all SSIDs on the specific EAP). Then click **Apply**.
- 3) Select a band frequency (2.GHz or 5GHz) and a WLAN group.
- 4) In the Profile Name column of the specified SSID or AP, select a profile you added before in the drop-down list. Select **Radio Off/Radio On** to turn off or on the wireless network during the time interval set for the profile.
- 5) Click **Apply** in the Setting column.

3.7 QoS

The Omada Controller software allows you to configure the quality of service (QoS) on the EAP for optimal throughput and performance when handling differentiated wireless traffic, such as Voice-over-IP (VoIP), other types of audio, video, streaming media, and traditional IP data.

To configure QoS on the EAP, you should set parameters on the transmission queues for different types of wireless traffic and specify minimum and maximum wait times (through contention windows) for transmission. In normal use, we recommend that you keep the default values for the EAPs and station EDCA (Enhanced Distributed Channel Access).

Follow the steps below to configure QoS.

1. Go to **Wireless Control > QoS**.

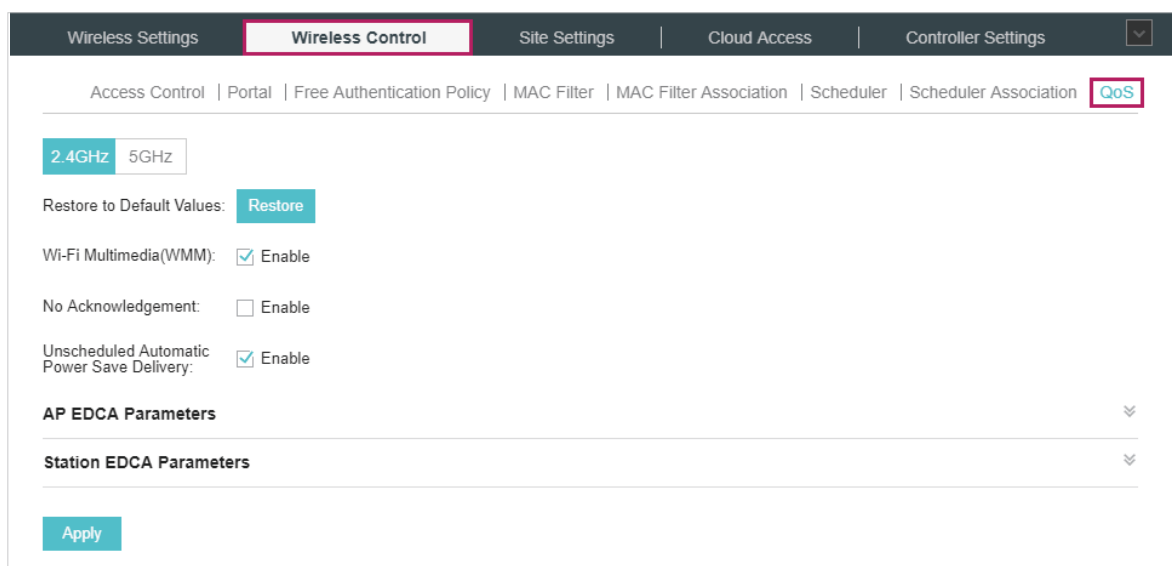

2. Enable or disable the following features.

Wi-Fi Multimedia (WMM)	By default enabled. With WMM enabled, the EAPs have the QoS function to guarantee the high priority of the transmission of audio and video packets. If 802.11n only mode is selected in 2.4GHz (or 802.11n only, 802.11ac only, or 802.11 n/ac mixed mode in 5GHz), the WMM should be enabled. If WMM is disabled, the 802.11n only mode cannot be selected in 2.4GHz (or 802.11n only, 802.11ac only, or 802.11 n/ac mixed mode in 5GHz).
No Acknowledgment	By default disabled. You can enable this function to specify that the EAPs should not acknowledge frames with QoS No Ack. Acknowledgeable is recommended if VoIP phones access the network through the EAP
Unscheduled Automatic Power Save Delivery	By default enabled. As a power management method, it can greatly improve the energy-saving capacity of clients.

3. Click **AP EDCA Parameters** and the following page will appear. AP EDCA parameters affect traffic flowing from the EAP to the client station. We recommend that you use the defaults.

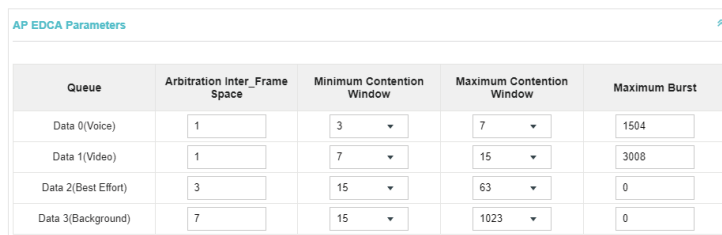

Queue	Arbitration Inter-Frame Space	Minimum Contention Window	Maximum Contention Window	Maximum Burst
Data 0 (Voice)	1	3	7	1504
Data 1 (Video)	1	7	15	3008
Data 2 (Best Effort)	3	15	63	0
Data 3 (Background)	7	15	1023	0

Queue	Queue displays the transmission queue. By default, the priority from high to low is Data 0, Data 1, Data 2, and Data 3. The priority may be changed if you reset the EDCA parameters. Data 0 (Voice) —Highest priority queue, minimum delay. Time-sensitive data such as VoIP and streaming media are automatically sent to this queue. Data 1 (Video) —High priority queue, minimum delay. Time-sensitive video data is automatically sent to this queue. Data 2 (Best Effort) —Medium priority queue, medium throughput and delay. Most traditional IP data is sent to this queue. Data 3 (Background) —Lowest priority queue, high throughput. Bulk data that requires maximum throughput and is not time-sensitive is sent to this queue (FTP data, for example).
Arbitration Inter-Frame Space	A wait time for data frames. The wait time is measured in slots. Valid values for Arbitration Inter-Frame Space are from 0 to 15.
Minimum Contention Window	A list to the algorithm that determines the initial random backoff wait time (window) for retry of a transmission. This value can not be higher than the value for the Maximum Contention Window .
Maximum Contention Window	The upper limit (in milliseconds) for the doubling of the random backoff value. This doubling continues until either the data frame is sent or the Maximum Contention Window size is reached. This value must be higher than the value for the Minimum Contention Window .

Maximum Burst

Maximum Burst specifies the maximum burst length allowed for packet bursts on the wireless network. A packet burst is a collection of multiple frames transmitted without header information. The decreased overhead results in higher throughput and better performance.

4. Click **Station EDCA Parameters** and the following page will appear. Station EDCA parameters affect traffic flowing from the client station to the EAP. We recommend that you use the defaults.

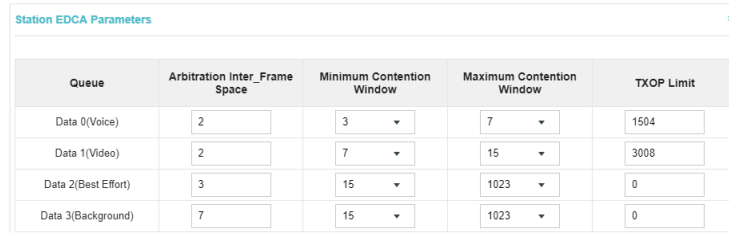

Queue	Arbitration Inter-Frame Space	Minimum Contention Window	Maximum Contention Window	TXOP Limit
Data 0(Voice)	2	3	7	1504
Data 1(Video)	2	7	15	3008
Data 2(Best Effort)	3	15	1023	0
Data 3(Background)	7	15	1023	0

Queue

Queue displays the transmission queue. By default, the priority from high to low is Data 0, Data 1, Data 2, and Data 3. The priority may be changed if you reset the EDCA parameters.

Data 0 (Voice)—Highest priority queue, minimum delay. Time-sensitive data such as VoIP and streaming media are automatically sent to this queue.

Data 1 (Video)—High priority queue, minimum delay. Time-sensitive video data is automatically sent to this queue.

Data 2 (Best Effort)—Medium priority queue, medium throughput and delay. Most traditional IP data is sent to this queue.

Data 3 (Background)—Lowest priority queue, high throughput. Bulk data that requires maximum throughput and is not time-sensitive is sent to this queue (FTP data, for example).

Arbitration Inter-Frame Space

A wait time for data frames. The wait time is measured in slots. Valid values for **Arbitration Inter-Frame Space** are from 0 to 15.

Minimum Contention Window

A list to the algorithm that determines the initial random backoff wait time (window) for retry of a transmission. This value can not be higher than the value for the **Maximum Contention Window**.

Maximum Contention Window

The upper limit (in milliseconds) for the doubling of the random backoff value. This doubling continues until either the data frame is sent or the Maximum Contention Window size is reached.

This value must be higher than the value for the **Minimum Contention Window**.

TXOP Limit

The **TXOP Limit** is a station EDCA parameter and only applies to traffic flowing from the client station to the EAP. The Transmission Opportunity (TXOP) is an interval of time, in milliseconds, when a WME client station has the right to initiate transmissions onto the wireless medium (WM) towards the EAP. The valid values are multiples of 32 between 0 and 8192.

5. Click **Apply**.

3.8 Site Settings

You can configure the site-specific settings on the **Site Settings** page. To switch sites, select a different site from the **Sites** drop-down menu at the top of any screen.

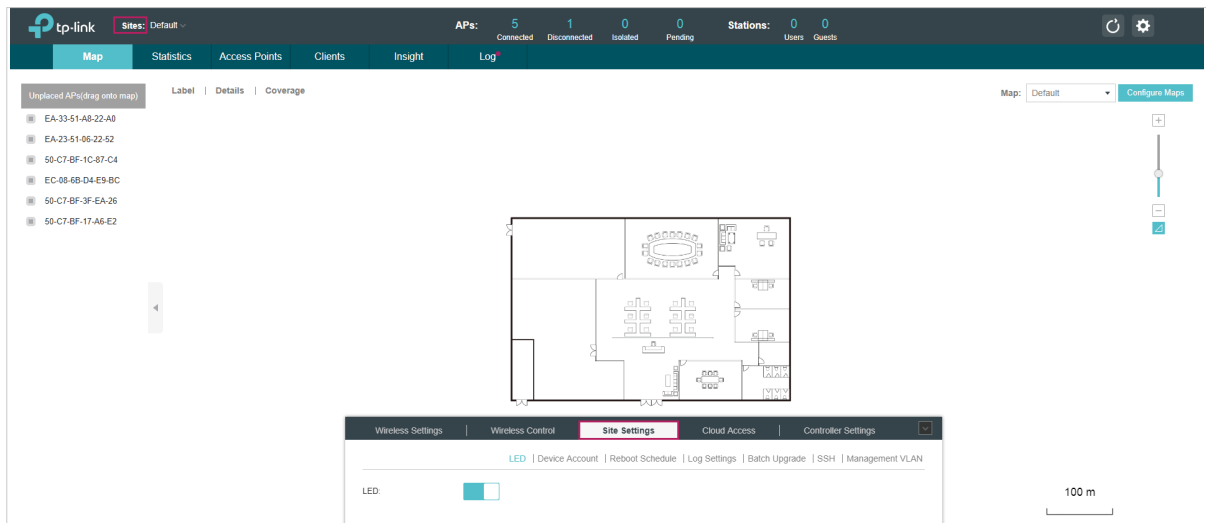

3.8.1 LED

You can change the LED light status on the EAPs on the page **Site Settings > LED**.

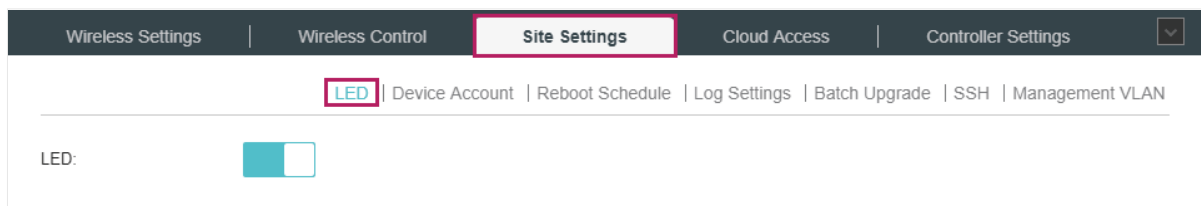

By default, the LED status is , which means that the LED lights of all the EAPs on the site are on. You can click this button to change the LED light status. The icon will be changed to , which means that all the LED lights are off.

3.8.2 Device Account

When the EAPs are adopted at the first time, their username and password will become the same as those of the Omada Controller which are specified at Basic Configurations. You can specify a new username and password for the adopted EAPs in batches.

Follow the steps below to change the username and password of EAPs.

1. Go to **Site Settings > Device Account**.

Wireless Settings | Wireless Control | **Site Settings** | Cloud Access | Controller Settings

LED | **Device Account** | Reboot Schedule | Log Settings | Batch Upgrade | SSH | Management VLAN

Current Username:

Current Password:

New Username:

New Password:

Apply

2. Specify a new username and password for the EAPs.

3. Click **Apply**.

Note:

- The new account will be applied to EAPs but not the Omada Controller. To change the Omada Controller's username and password, please refer to [User Account](#).
- Device account can be only viewed and changed when you log in to the controller as the administrator. While the operator and observer accounts do not have the permission.

3.8.3 Reboot Schedule

You can reboot all the EAPs in the network periodically as needed. Follow the steps below to configure Reboot Schedule.

1. Go to **Site Settings > Reboot Schedule**.

Wireless Settings | Wireless Control | **Site Settings** | Cloud Access | Controller Settings

LED | Device Account | **Reboot Schedule** | Log Settings | Batch Upgrade | SSH | Management VLAN

Reboot Schedule: Enable

Timing Mode:

Reboot Time: : :

Apply

2. Check the box to enable the function.

3. Choose **Daily**, **Weekly** or **Monthly** in the **Timing Mode** drop-down list and set a specific time to reboot the EAPs.

4. Click **Apply**.

3.8.4 Log Settings

Follow the steps below to choose the way to receive system logs.

1. Go to **Site Settings > Log Setting**.

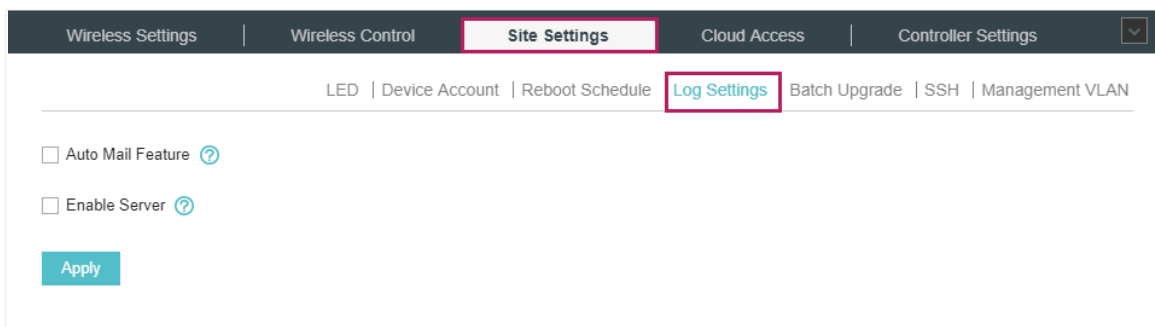

2. Check the box to choose the ways to receive system logs and click **Apply**. Two ways are available: **Auto Mail Feature** and **Server**. You can choose more than one way.

Note:

The logs and alerts of the controller with version 3.0.5 or below will be discarded after the controller is upgraded to version 3.1.4 or above.

Auto Mail Feature

If Auto Mail Feature is enabled, system logs will be sent to a specified mailbox. Check the box to enable the feature and configure the parameters.

Receiver Address	Enter the receiver's E-mail address.
SMTP Server	Enter the IP address or domain name of the SMTP server.
Port	The SMTP server uses port 25 as default. If SSL is enabled, the port number will automatically change to 465.
SSL	You can check the box to enable SSL (Security Socket Layer) to enhance secure communications over the internet.
Authentication	You can check the box to enable mail server authentication. Enter the sender's mail account name and password.

Username	Enter the sender's mail account name.
Password	Enter the sender's mail password.
Sender Address	Enter the sender's E-mail address.
Time Mode	Select Time Mode. System logs can be sent at specific time or time interval.
Fixation Time	<p>If you select Fixation Time, specify a fixed time to send the system log mails. For example, 08:30 indicates that the mail will be sent at 8:30 am everyday.</p> <div style="border: 1px solid #ccc; padding: 5px; width: fit-content; margin: 10px auto;"> <p>Time Mode: <input checked="" type="radio"/> Fixation Time <input type="radio"/> Period Time</p> <p>Fixation Time: <input type="text" value="00"/> : <input type="text" value="00"/> (HH:MM)</p> </div>
Period Time	<p>If you select Period Time, specify a period time to regularly send the system log mail. For example, 6 indicates that the mail will be sent every six hours.</p> <div style="border: 1px solid #ccc; padding: 5px; width: fit-content; margin: 10px auto;"> <p>Time Mode: <input type="radio"/> Fixation Time <input checked="" type="radio"/> Period Time</p> <p>Period Time: <input type="text"/> Hours(1-24)</p> </div>

Server

If Server is enabled, system logs will be sent to a server. Check the box to enable the feature and configure the parameters.

Enable Server

System Log Server IP:

System Log Server Port:

More Client Detail Log:

System Log Server IP	Enter the IP address of the server.
System Log Server Port	Enter the port of the server.
More Client Detail Log	With the option enabled, the logs of clients will be sent to the server.

3.8.5 Batch Upgrade

You can upgrade your EAPs of the same model in batches using Batch Upgrade. Two options are available for upgrading: upgrade online and upgrade manually.

Upgrade Online

With Cloud Access enabled, the latest firmware for the EAPs can be detected by the controller automatically. And you can upgrade the EAPs online. Thus you need not to save the firmware files locally in advance.

Follow the steps below to upgrade the EAPs online according to their model.

1. Go to **Cloud Access**. Click the button to enable Cloud Access and log in and bind with your TP-Link ID. For more details about Cloud Access, please refer to [Omada Cloud Service](#).
2. Go to **Site Settings > Batch Upgrade**. The device model, amount, current firmware and available firmware will appear on the **Firmware list**.

Device Model	Connected	Current Firmware	Available Firmware	Action
EAP225(EU) 3.0	1	2.2.0 Build 20180411 Rel. 62961	2.3.0 Build 20180628 Rel. 54512 ⓘ	⬆️ ⬆️
EAP225-Outdoor(EU) 1.0	2	1.3.0 Build 20180614 Rel. 50359	Up to date	⬆️ ⬆️

3. Click [⬆️](#) in the **Action** column to upgrade the device.

After upgrading, the device will reboot automatically.

Tips:

- You can click [Check for firmware upgrade](#) to check if the latest firmware is available.
- You can click ⓘ in the **Available Firmware** column to view the release note of the firmware, which can help you know the new features or improvements of this firmware.

Upgrade Manually

The latest firmware files can be downloaded in the download center of TP-Link Website. Then you can upgrade the EAPs manually.

Follow the steps below to upgrade the EAPs manually according to their model.

1. Visit <http://www.tp-link.com/en/support/download/> to download the latest firmware file of the corresponding model.

2. Go to **Site Settings > Batch Upgrade**.

Wireless Settings | Wireless Control | **Site Settings** | Cloud Access | Controller Settings

LED | Device Account | Reboot Schedule | Log Settings | **Batch Upgrade** | SSH | Management VLAN

Firmware List

Check for firmware upgrade

Device Model	Connected	Current Firmware	Available Firmware	Action
EAP225(EU) 3.0	1	2.2.0 Build 20180411 Rel. 62961	2.3.0 Build 20180628 Rel. 54512 ⓘ	↑ ↑
EAP225-Outdoor(EU) 1.0	2	1.3.0 Build 20180614 Rel. 50359	Up to date	↑ ↑

<< < 1 > >> A total of 1 page(s) Page to: GO

3. Click [↑](#) in the **Action** column to upgrade the device.

Upload Firmware [Close]

Upgrade File: **Browse** **Upgrade**

4. Click **Browse** to locate and choose the proper firmware file for the model.

5. Click **Upgrade** to upgrade the device.

After upgrading, the device will reboot automatically.

Note:

- The EAP cannot be upgraded manually when you access the controller via Omada Cloud.
- To avoid damage, please do not turn off the device while upgrading.

3.8.6 SSH

SSH is a protocol working in application layer and transport layer. It can provide a secure, remote connection to a device. After enabling SSH Login here, you can log in to the EAPs via SSH.

1. Go to **Site Setting > SSH**. Enter the port number of the SSH server.

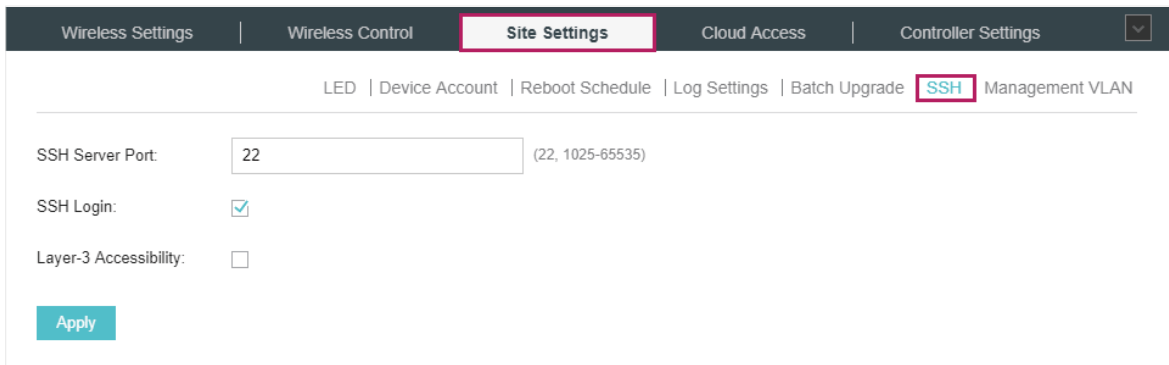

The screenshot shows the 'Site Settings' page in a web interface. The top navigation bar includes 'Wireless Settings', 'Wireless Control', 'Site Settings' (highlighted with a red box), 'Cloud Access', and 'Controller Settings'. Below the navigation bar, there are links for 'LED', 'Device Account', 'Reboot Schedule', 'Log Settings', 'Batch Upgrade', 'SSH' (highlighted with a red box), and 'Management VLAN'. The main content area contains the following settings:

- SSH Server Port: (22, 1025-65535)
- SSH Login:
- Layer-3 Accessibility:

An 'Apply' button is located at the bottom left of the settings area.

2. Check the box to enable **SSH Login**. If you want to log in to the EAP from a different subnet via SSH, enable **Layer-3 Accessibility**.
3. Click **Apply**.

3.8.7 Management VLAN

Management VLAN provides a safer way for you to manage the EAP. With Management VLAN enabled, only the hosts in the management VLAN can manage the EAP. Since most hosts cannot process VLAN TAGs, connect the management host to the network via a switch, and set up correct VLAN settings for the switches on the network to ensure the communication between the host and the EAP in the management VLAN.

Follow the steps below to configure Management VLAN.

1. Go to **Site Setting > Management VLAN**. Check the box to enable Management VLAN.

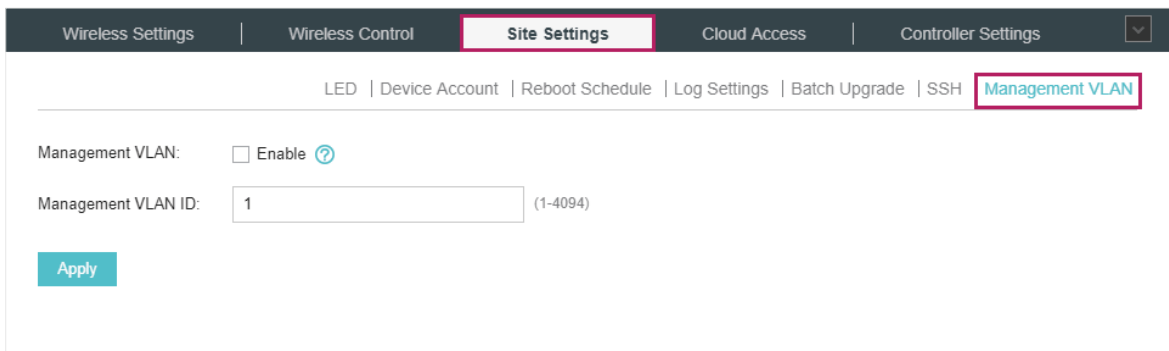

The screenshot shows the 'Site Settings' page in a web interface. The top navigation bar includes 'Wireless Settings', 'Wireless Control', 'Site Settings' (highlighted with a red box), 'Cloud Access', and 'Controller Settings'. Below the navigation bar, there are links for 'LED', 'Device Account', 'Reboot Schedule', 'Log Settings', 'Batch Upgrade', 'SSH', and 'Management VLAN' (highlighted with a red box). The main content area contains the following settings:

- Management VLAN: Enable [?](#)
- Management VLAN ID: (1-4094)

An 'Apply' button is located at the bottom left of the settings area.

2. Specify the Management VLAN ID. The default VLAN ID is 1.
3. Click **Apply**.

4

Omada Cloud Service

TP-Link Omada Cloud Service provides a better way to realize remote management. With Cloud Access enabled on the controller and a TP-Link ID bound with your controller, and you can easily monitor and manage your wireless network. To ensure that your EAPs stay new and get better over time, the Omada Cloud will notify you when a newer firmware upgrade is available. Surely you can also manage multiple Omada Controllers with a single TP-Link ID.

Follow the steps below to configure Cloud Access and access the controller via Omada Cloud:

1. [Configure the Cloud Access](#)
2. [Manage the Controller via Omada Cloud](#)

4.1 Configure the Cloud Access

4.1.1 Enable Cloud Access

You can configure the controller via Omada Cloud only when Cloud Access is enabled on the controller and you have been added as a Cloud User.

On the page **Cloud Access** you can configure Cloud Access. Click the button to enable the **Cloud Access**. The Cloud Access status is , which means that the Cloud Access is enabled.

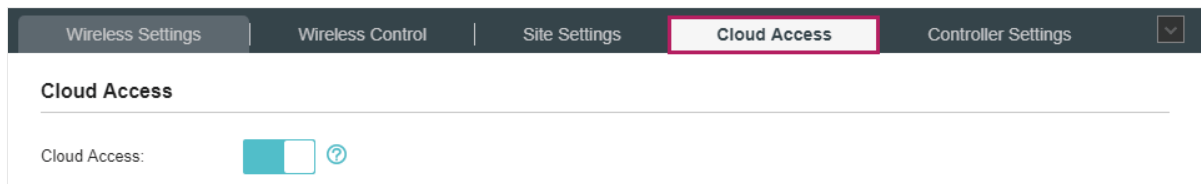

4.1.2 Manage the Cloud Users

To configure and manage Omada Controller through Cloud service, you need to have a TP-Link ID, and bind your TP-Link ID to the controller. Then you can remotely access the controller as a Cloud User.

Note:

To register a TP-Link ID and bind it to your controller, make sure that the controller host can access the internet.

Register a TP-Link ID

In the Quick Setup process, you can register a TP-Link ID and bind it to your controller. If you have skipped the registration during the Quick Setup process, you can go to **Cloud Access**. Click **Register Now** and follow the instructions to register a TP-Link ID.

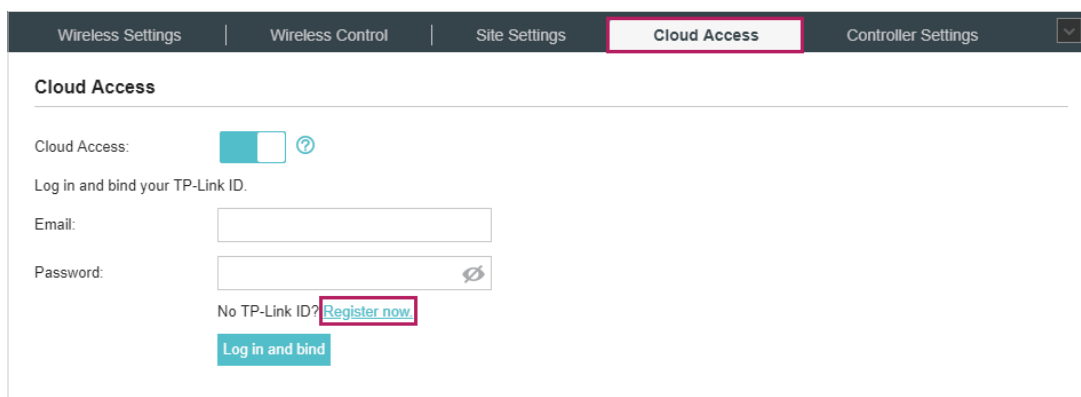

Log in and bind your TP-Link ID

After activating your TP-Link ID, come back to **Cloud Access** page to log in and bind your TP-Link ID to your controller.

Wireless Settings | Wireless Control | Site Settings | **Cloud Access** | Controller Settings

Cloud Access

Cloud Access: ?

Log in and bind your TP-Link ID.

Email:

Password:

No TP-Link ID? [Register now.](#)

Log in and bind

The TP-Link ID which is bound with the controller for the first time will be automatically bound as an administrator. And only one TP-Link ID can be bound with the controller as an administrator. An administrator account can add or remove other TP-Link IDs to or from the same controller as Cloud Users.

Wireless Settings | Wireless Control | Site Settings | **Cloud Access** | Controller Settings

Cloud Access Online

Cloud Access: ?

TP-Link ID (Owner): administrator@tp-link.com **Unbind**

[+ Add Cloud User](#)

TP-Link ID	Role	Site	Created Time	Action
administrator@tp-link.com	administrator	All Sites	2018-08-14 11:21:28	

<< < 1 > >> A total of 1 page(s) Page to: **GO**

Add new Cloud Users

After you have an administrator TP-Link ID, you can add new Cloud Users. Click [+ Add Cloud User](#) , enter another TP-Link ID as needed and click **Save**.

Add Cloud User ✕

TP-Link ID:

No TP-Link ID? [Register now.](#)

Role: ▼

Site Privileges: ▼

Apply

TP-Link ID	Enter the TP-Link ID that you want to add as the new Cloud User. If you do not have another TP-Link ID, you can click Register Now and follow the instructions to register a TP-Link ID.
Role	<p>Select the role for the new Cloud User from the drop-down list. Two options are provided:</p> <p>Operator: An Operator account can change the settings of the privileged sites that are given by the administrator. And the Operator account cannot manage the cloud users and change controller settings.</p> <p>Observer: An Observer account can only view the status and settings of the privileged sites that are given by the administrator but not change the settings.</p> <p>Both the Operator and Observer accounts cannot manage the cloud users and controller settings. Thus Operator and Observer accounts can only be created or deleted by the administrator.</p>
Site Privileges	Select the privileged sites (multiple options available) for the Operator or Observer accounts from the drop-down list.

Unbind a TP-Link ID

You can click **Unbind** to unbind your administrator TP-Link ID. Note that Unbind operation cannot be performed when you log in to the controller through Omada Cloud service.

Wireless Settings | Wireless Control | Site Settings | **Cloud Access** | Controller Settings

Cloud Access Online

Cloud Access: ?

TP-Link ID (Owner): administrator@tp-link.com **Unbind**

+ Add Cloud User

↕ TP-Link ID	Role	Site	Created Time	Action
administrator@tp-link.com	administrator	All Sites	2018-08-03 18:29:46	
operator001@tp-link.com	operator	site2	2018-08-14 11:42:23	
operator002@tp-link.com	operator	Default	2018-08-14 17:34:39	
observer@tp-link.com	observer	site1	2018-08-15 16:00:20	

<< < 1 > >> A total of 1 page(s) Page to: **GO**

4.2 Manage the Controller via Omada Cloud

With Cloud Access enabled, you can manage your controller remotely using your TP-Link ID. You can refer to the following topology.

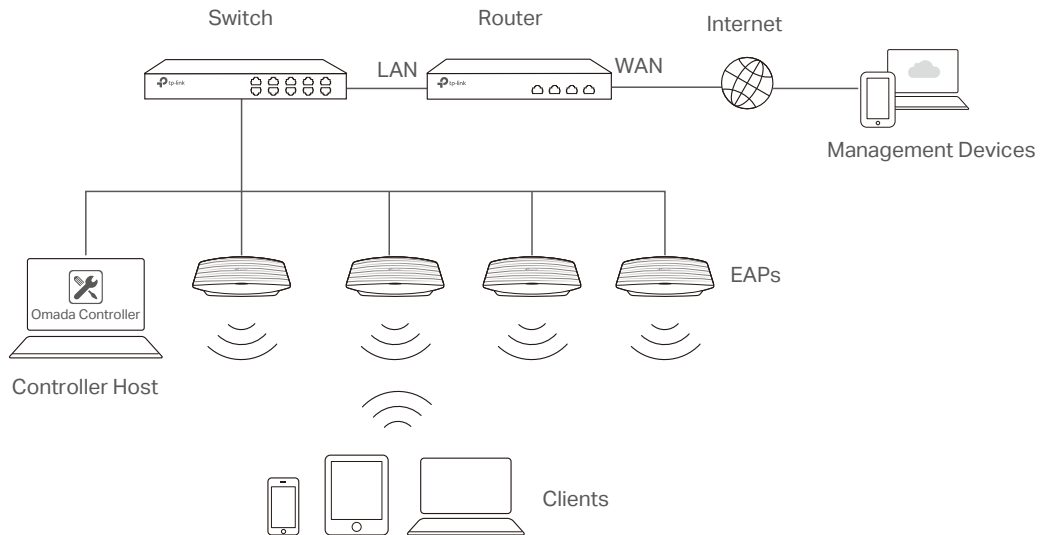

Before you remotely access your controller, make sure that the following requirements have been met:

- Cloud Access is enabled on the controller.
- Your controller has been bound with a TP-Link ID. If you don't have a TP-Link ID, refer to [Register a TP-Link ID](#) to get one.
- Both your Controller Host and management devices have internet access.

4.2.1 Access the controller via Omada Cloud

1. Launch a web browser and type <https://omada.tplinkcloud.com> in the address bar, then press **Enter** (Windows) or **Return** (Mac).

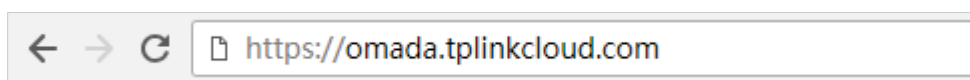

2. Enter your TP-Link ID and password and click **Log In**.

Log In

Enter with your TP-Link ID and password.

Email

Password



Remember Me

[Log In](#)











[Forgot Password?](#)

[Sign Up](#)

3. After you log in to Omada Cloud, a list of controllers that has been bound with your TP-Link ID will appear. If the controller does not appear on the list, you can click  to refresh the current page.

tp-link | OMADA CLOUD  

All OC200 Software Controller [Add Cloud Controller](#)



NAME	MAC ADDRESS	LOCAL IP	STATUS	SITES	DEVICES	CLIENTS	ALERTS	VERSION	FIRMWARE	ACTION
Omada Controller_DDF48D	-	-	Offline	-	-	-	-	3.0.2	-	 Launch  Unbind
Omada Controller_0523A9	-	-	Offline	-	-	-	-	3.0.3	-	 Launch  Unbind
Omada Controller_DD6948	-	-	Offline	-	-	-	-	3.0.3	-	 Launch  Unbind
Omada Controller_2EE6B0	-	192.168.0.162	Online	1	2	0	6	3.0.2	-	 Launch  Unbind
Omada Controller_3098FA	-	-	Offline	-	-	-	-	3.0.2	-	 Launch  Unbind

Page Size: 10 << < 1 > >>

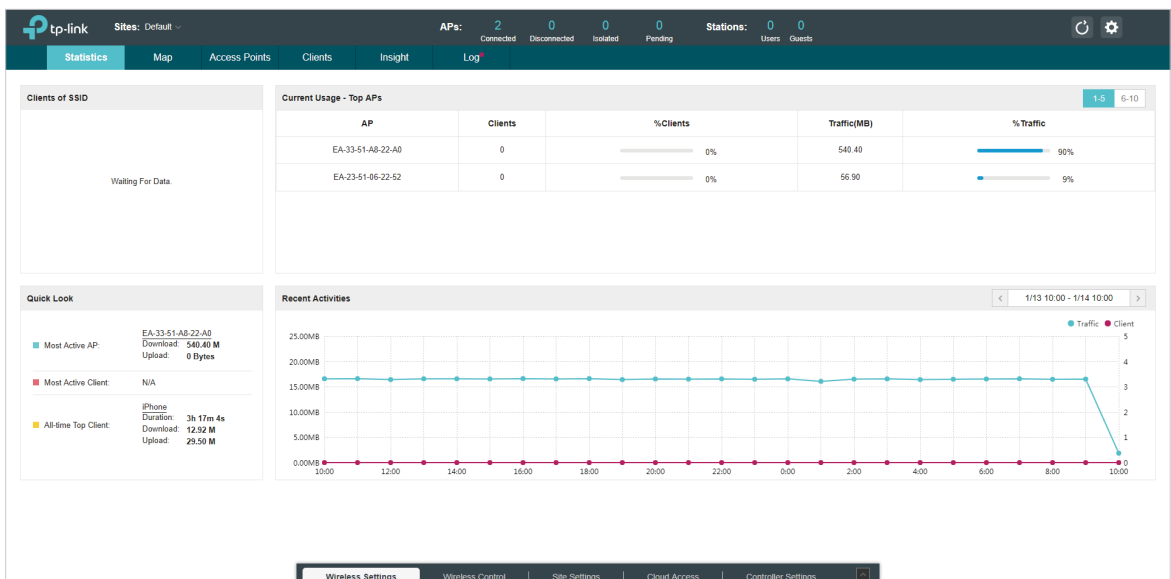
Click **Launch** to access your controller. Then you can configure and manage your controller.



Note:

- To Refresh the page, click  . Automatic refreshing is not available when accessing the controller via Omada Cloud.
- To remove the Omada Controller from your cloud account, you can click  Unbind .
- To log out Omada Cloud, click  and select **Log Out**.

4.2.2 Change your TP-Link ID information

You can change your TP-Link ID information on the Omada Cloud page. Click  and select **My TP-Link ID**, the cloud accounting settings will appear.

You can have a nickname for your TP-Link ID. Enter your nick name and click **Save**.

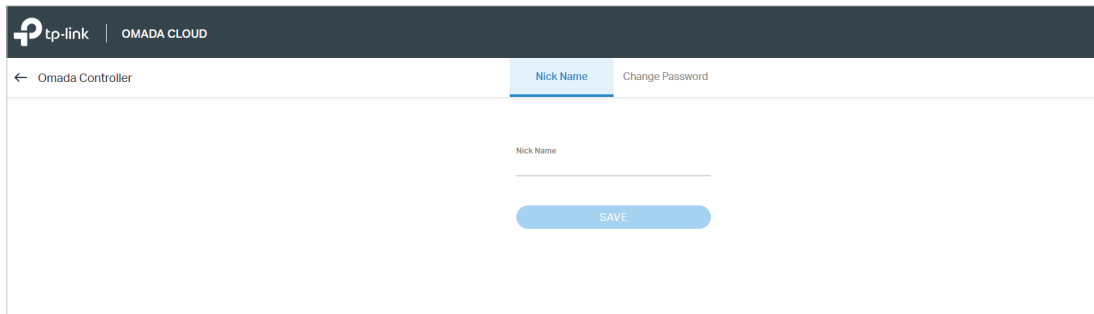

The screenshot shows the Omada Cloud interface. At the top, there is a dark header with the TP-Link logo and 'OMADA CLOUD'. Below the header, there is a navigation bar with a back arrow and 'Omada Controller', and two tabs: 'Nick Name' (which is selected and highlighted in blue) and 'Change Password'. The main content area contains a form with a single input field labeled 'Nick Name' and a blue 'SAVE' button below it.

You can also change the password of your TP-Link ID. Enter the current password, then a new password twice and click **Save**.

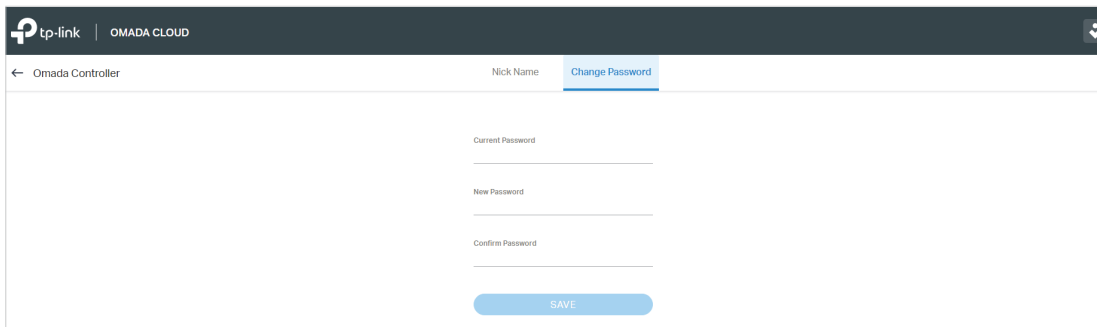

The screenshot shows the Omada Cloud interface. At the top, there is a dark header with the TP-Link logo and 'OMADA CLOUD'. Below the header, there is a navigation bar with a back arrow and 'Omada Controller', and two tabs: 'Nick Name' and 'Change Password' (which is selected and highlighted in blue). The main content area contains a form with three input fields: 'Current Password', 'New Password', and 'Confirm Password', and a blue 'SAVE' button below them.

5

Configure the EAPs Separately

In addition to global configuration, you can configure the EAPs separately and the configuration results will be applied to a specified EAP.

To configure a specified EAP, please click the EAP's name on the **Access Points** tab or click  of connected EAP on the map. Then you can view the EAP's detailed information and configure the EAP on the pop-up window.

This chapter includes the following contents:

- *View the Information of the EAP*
- *View Clients Connecting to the EAP*
- **View Mesh Information of the EAP**
- **Configure the EAP**

5.1 View the Information of the EAP

5.1.1 Active Channel Information

The active channel information on each radio band will be displayed in a bar graph, which indicates its percentages of the following: Rx Frames (blue), Tx Frames (green), Interference (orange), and Free bandwidth (gray). The percentage of channel utilization is also displayed with the corresponding evaluation.

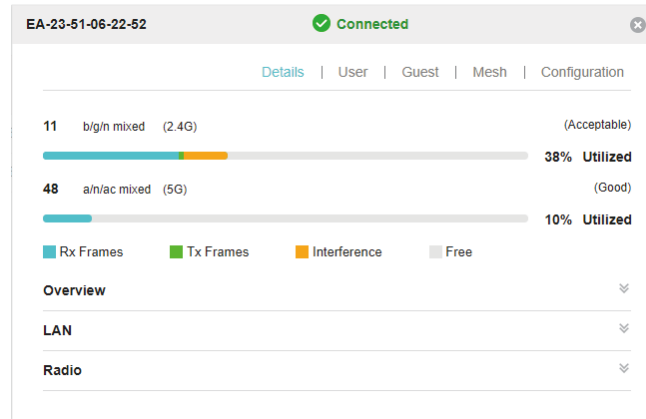

You can click a point on either bar graph for more details:

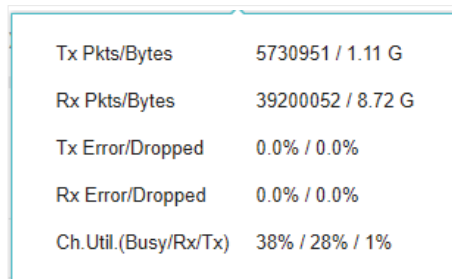

Tx Pkts/Bytes	Displays the amount of data transmitted as packets and bytes.
Rx Pkts/Bytes	Displays the amount of data received as packets and bytes.
Tx Error/Dropped	Displays the percentage of transmit packets that have errors and the percentage of packets that were dropped.
Rx Error/Dropped	Displays the percentage of receive packets that have errors and the percentage of packets that were dropped.
Ch.Util.(Busy/Rx/Tx)	Displays channel utilization statistics. Busy: This number is the sum of Tx, Rx, and also non-WiFi interference, which indicates how busy the channel is. Rx: This number indicates how often the radio is in active receive mode. Tx: This number indicates how often the radio is in active transmit mode.

5.1.2 Overview

Click **Overview** to view the basic information of the EAP which includes EAP's MAC address (or name you set), IP address, model, firmware version, the usage rate of CPU and Memory and uptime (indicates how long the EAP has been running without interruption).

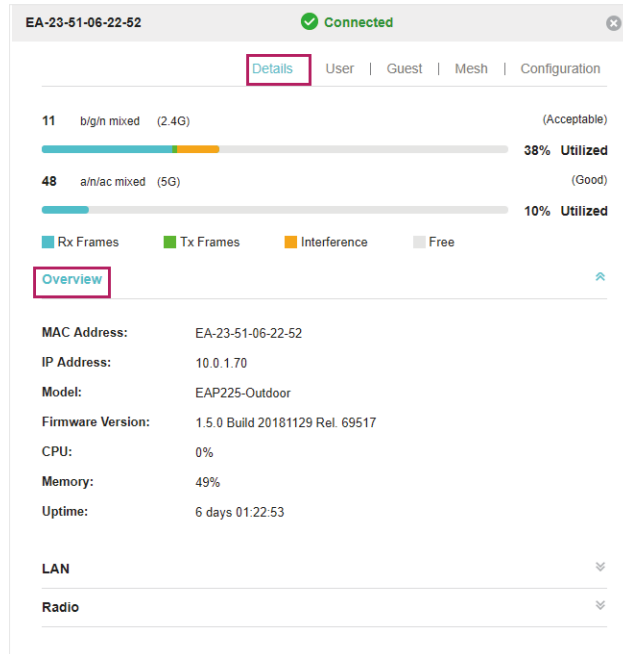

5.1.3 LAN

Click **LAN** to view the traffic information of the LAN port, including the total number of packets, the total size of data, the total number of packets loss, and the total size of error data in the process of receiving and transmitting data.

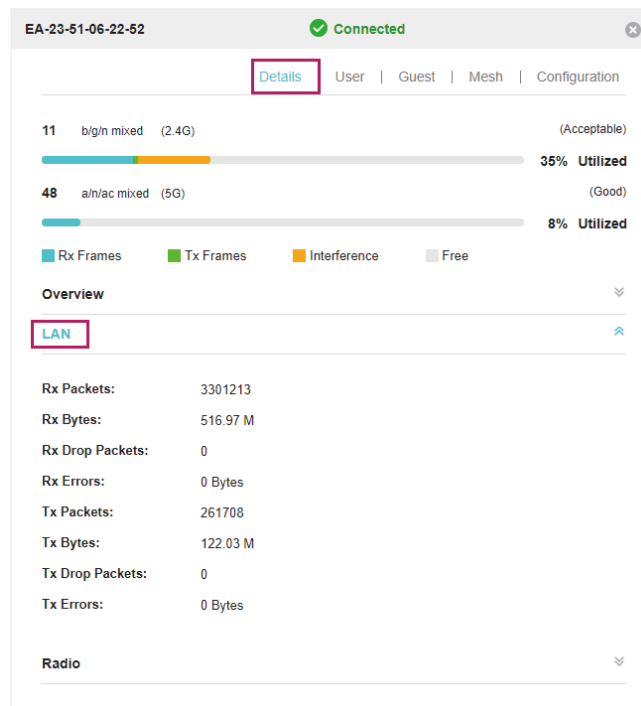

5.1.4 Radio

Click **Radio** to view the radio information including the frequency band, the wireless mode, the channel width, the channel, and the transmitting power. You can also view parameters of receiving/transmitting data on each radio band.

The screenshot shows the 'Radio' configuration page for a device with ID EA-23-51-06-22-52. The page is titled 'Connected' and has tabs for 'Details', 'User', 'Guest', 'Mesh', and 'Configuration'. The 'Details' tab is active. It displays two radio bands: 11 b/g/n mixed (2.4G) with 35% utilization (Acceptable) and 48 a/n/ac mixed (5G) with 8% utilization (Good). A legend indicates Rx Frames (blue), Tx Frames (green), Interference (orange), and Free (grey). Below this is an 'Overview' section, followed by a 'LAN' section, and a 'Radio' section which is highlighted with a red box. The 'Radio' section has tabs for '2.4GHz' and '5GHz'. The '2.4GHz' tab is selected, showing the following parameters:

Mode:	802.11b/g/n mixed
Channel Width:	20/40MHz
Channel:	11 / 2462MHz
Tx Power:	20
Rx Packets:	45441772
Rx Bytes:	10.28 G
Rx Drop Packets:	0
Rx Errors:	0 Bytes
Tx Packets:	6534936
Tx Bytes:	1.26 G
Tx Drop Packets:	0
Tx Errors:	0 Bytes

5.2 View Clients Connecting to the EAP

5.2.1 User

The **User** page displays the information of clients connecting to the SSID with Portal disabled, including their MAC addresses and connected SSIDs. You can click the client's MAC address to get its connection history.

The screenshot shows the 'User' page for the same device. The 'User' tab is active and highlighted with a red box. It features a search bar for 'MAC, SSID' and a table of connected clients. The table has two columns: 'MAC Address' and 'SSID'. Below the table is a pagination control showing 'A total of 1 page(s) Page to: [input] GO'.

MAC Address	SSID
A4-44-D1-DE-7B-AB	SSID1
CC-2D-83-05-52-5C	SSID1

5.2.2 Guest

The **Guest** page displays the information of clients connecting to the SSID with Portal enabled, including their MAC addresses and connected SSIDs. You can click the client's MAC address to get its connection history.

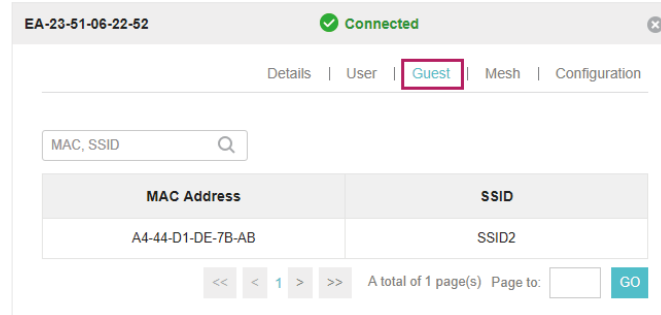

5.3 View Mesh Information of the EAP

The **Mesh** page is used to view and configure the mesh parameters of the EAP.

5.3.1 Uplinks

Here you can view the parameters of the uplink APs or click [Link](#) to change the uplink AP.

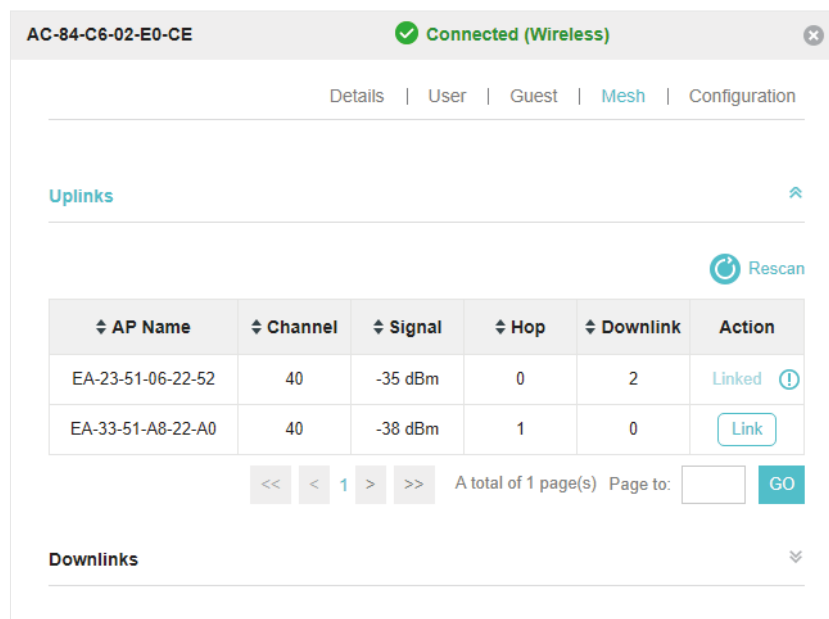

Tips:

- You can click [Rescan](#) to search the available uplink APs and the Uplink list will refresh.
- To build a mesh network with better performance, we recommend that you select the Uplink AP with the strongest signal, least hop and least Downlink AP.

5.3.2 Downlinks

Here you can view the downlink APs.

EA-33-51-A8-22-A0 Connected (Wireless)

Details | User | Guest | Mesh | Configuration

Uplinks

Downlinks

AP Name	Signal
AC-84-C6-02-E0-CE	-52 dBm

<< < 1 > >> A total of 1 page(s) Page to: GO

5.4 Configure the EAP

The Configuration page is used to configure the EAP. All the configurations will only take effect on this device.

EA-23-51-06-22-52 Connected

Details | User | Guest | Mesh | Configuration

Basic Config

Name:

Apply

IP Setting

Radio

Load Balance

WLANS

Rogue AP Detection

Forget this AP

5.4.1 Basic Config

Here you can change the name of the EAP.

Basic Config

Name:

Apply

5.4.2 IP Setting

You can configure an IP address for this EAP. Two options are provided: DHCP and Static.

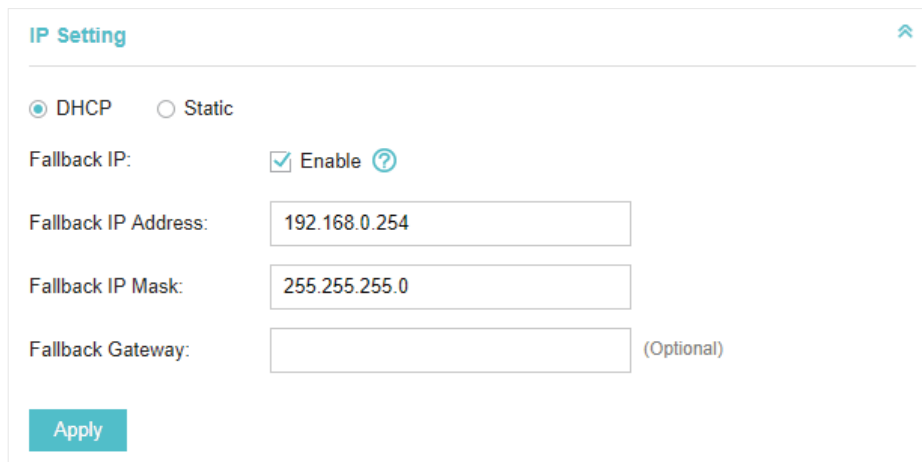

The screenshot shows a configuration window titled "IP Setting" with a close button in the top right corner. It features two radio buttons: "DHCP" (selected) and "Static". Below these, there is a "Fallback IP:" section with a checked "Enable" checkbox and a help icon. Three input fields are provided: "Fallback IP Address" containing "192.168.0.254", "Fallback IP Mask" containing "255.255.255.0", and "Fallback Gateway" which is empty and labeled "(Optional)". An "Apply" button is located at the bottom left of the form.

Get a Dynamic IP Address From the DHCP Server

1. Configure your DHCP server.
2. Select **DHCP** on the page above.
3. Enable the Fallback IP feature. When the device cannot get a dynamic IP address, the fallback IP address will be used.
4. Set IP address, IP mask and gateway for the fallback address and click **Apply**.

Manually Set a Static IP Address for the EAP

1. Select **Static**.
2. Set the IP address, IP mask and gateway for the static address and click **Apply**.

5.4.3 Radio

Radio settings directly control the behavior of the radio in the EAP and its interaction with the physical medium; that is, how and what type of signal the EAP emits.

Select the frequency band (2.4GHz/5GHz) and configure the following parameters.

Status	Enabled by default. If you disable the option, the radio on the frequency band will turn off.
Mode	Select the IEEE 802.11 mode the radio uses. When the frequency of 2.4GHz is selected, 802.11b/g/n mixed, 802.11b/g mixed, and 802.11n only modes are available: 802.11b/g/n mixed: All of 802.11b, 802.11g, and 802.11n clients operating in the 2.4GHz frequency can connect to the EAP. We recommend that you select the 802.11b/g/n mixed mode. 802.11b/g mixed: Both 802.11b and 802.11g clients can connect to the EAP. 802.11n only: Only 802.11n clients can connect to the EAP. When the frequency of 5GHz is selected, 802.11 n/ac mixed, 802.11a/n mixed, 802.11 ac only, 802.11a only, and 802.11n only modes are available: 802.11n/ac mixed: Both 802.11n clients and 802.11ac clients operating in the 5GHz frequency can connect to the EAP. 802.11a/n mixed: Both 802.11a clients and 802.11n clients operating in the 5GHz frequency can connect to the EAP. 802.11ac only: Only 802.11ac clients can connect to the EAP. 802.11a only: Only 802.11a clients can connect to the EAP. 802.11n only: Only 802.11n clients can connect to the EAP.
Channel Limit	For the EAPs that support DFS in EU version, there is a Channel Limit option. If you want to use your EAP outdoors, enable this option to comply with the laws in your country.

Channel Width	<p>Select the channel width of the EAP. The available options differ among different EAPs.</p> <p>For some EAPs, available options include 20MHz, 40MHz and 20/40MHz.</p> <p>For other EAPs, available options include 20MHz, 40MHz, 80MHz and 20/40/80MHz.</p> <p>The 20/40 MHz and 20/40/80MHz channels enable higher data rates but leave fewer channels available for use by other 2.4GHz and 5GHz devices. When the radio mode includes 802.11n, we recommend that you set the channel bandwidth to 20/40 MHz or 20/40/80MHz to improve the transmission speed.</p>
Channel	<p>Select the channel used by the EAP to improve wireless performance. The range of available channels is determined by the radio mode and the country setting. If you select Auto for the channel setting, the EAP scans available channels and selects a channel where the least amount of traffic is detected.</p>
Tx Power (EIRP)	<p>Select the Tx Power (Transmit Power) in the 4 options: Low, Medium, High and Custom. Low, Medium and High are based on the Min. Txpower (Minimum transmit power) and Max. TxPower (Maximum transmit power. It may vary among different countries and regions).</p> <p>Low: $\text{Min. TxPower} + (\text{Max. TxPower} - \text{Min. TxPower}) * 20\%$ (round off the value)</p> <p>Medium: $\text{Min. TxPower} + (\text{Max. TxPower} - \text{Min. TxPower}) * 60\%$ (round off the value)</p> <p>High: Max. TxPower</p> <p>Custom: Enter a value manually.</p>

5.4.4 Load Balance

By setting the maximum number of clients accessing the EAPs, Load Balance helps to achieve rational use of network resources.

Select the frequency band (2.4GHz/5GHz) and configure the parameters.

Max Associated Clients	<p>Enable this function and specify the maximum number of connected clients. While more clients requesting to connect, the EAP will disconnect those with weaker signals.</p>
------------------------	---

RSSI Threshold

Enable this function and enter the threshold of **RSSI** (Received Signal Strength Indication). When the clients' signal is weaker than the **RSSI Threshold** you've set, the clients will be disconnected from the EAP.

5.4.5 WLANs

You can specify a different SSID name and password to override the previous SSID. After that, clients can only see the new SSID and use the new password to access the network. Follow the steps below to override the SSID.

Name	Band	Overrides	Action
SSID1	2.4GHz, 5GHz		
SSID2	2.4GHz		

1. Select the WLAN group.
2. Click and the following window will pop up.

Enable: Enable On AP

VLAN: Use VLAN ID (1-4094)

SSID:

PSK: (WPA-PSK)

3. Check the box to enable the feature.
4. You can join the overridden SSID in to a VLAN. Check the **Use VLAN ID** box and specify a VLAN ID.
5. Specify a new name and password for the SSID.
6. Click **Apply** to save the configuration.

5.4.6 LED

You can change the LED status of each EAP.

Use Site Setting On Off

Using Site Setting	The LED status will be the same as the site settings.
On	Turn on the LED.
Off	Turn off the LED.

5.4.7 Trunk Settings (Only for EAP330)

The trunk function can bundles multiple Ethernet links into a logical link to increase bandwidth and improve network reliability.

Status	<p>Enable this function.</p> <p>The EAP330 has two 1000Mbps Ethernet ports. If the Trunk function is enabled and the ports are in the speed of 1000Mbps Full Duplex, the whole bandwidth of the trunk link is up to 4Gbps (2000Mbps * 2).</p>
Mode	<p>Select the applied mode of Trunk Arithmetic from the drop-down list.</p> <p>MAC_DA+MAC_SA: When this option is selected, the arithmetic will be based on the source and destination MAC addresses of the packets.</p> <p>MAC_DA: When this option is selected, the arithmetic will be based on the destination MAC addresses of the packets.</p> <p>MAC_SA: When this option is selected, the arithmetic will be based on the source MAC addresses of the packets.</p>

5.4.8 Rogue APs Detection

With this option enabled, the EAP will detect rogue APs in all channels. You can view the results in **Insight > Untrusted Rogue APs** page.

Note:

For some specific versions of the firmware, some EAPs will detect rogue APs automatically when this option is enabled.

5.4.9 Local LAN Port Settings (Only for EAP115-Wall and EAP225-Wall)

You can configure the LAN port of the EAP.

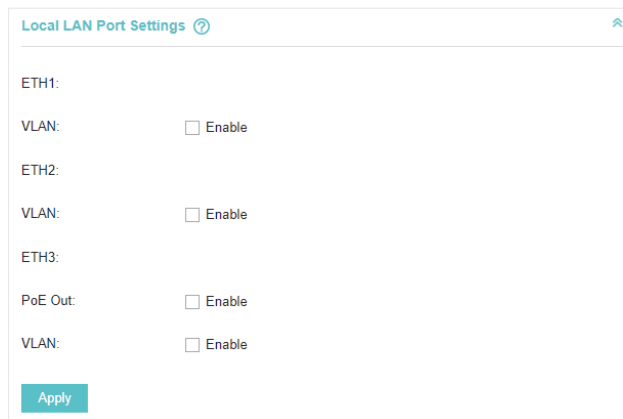

Local LAN Port Settings ?

ETH1:
VLAN: Enable

ETH2:
VLAN: Enable

ETH3:
PoE Out: Enable
VLAN: Enable

Apply

VLAN

Enable this feature and specify the VLAN that the EAP is added to, and then the hosts connected to this EAP can only communicate with the devices in this VLAN. The valid values are from 1 to 4094, and the default is 1.

PoE Out

If your EAP has PoE OUT port, you can enable this option to supply power to the connected device on this port.

The EAP that has no PoE OUT port does not support this feature.

5.4.10 Forget this AP

If you no longer want to manage this EAP, you may remove it. All the configurations and history about this EAP will be deleted. It is recommended to back up the configurations of this EAP before you forget it.

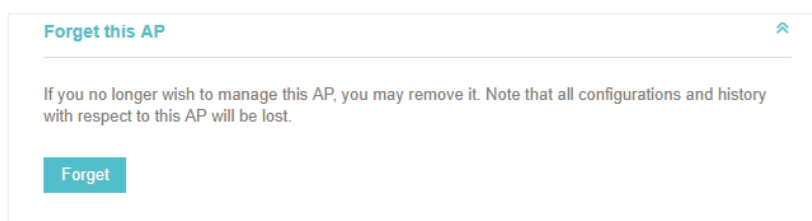

Forget this AP ?

If you no longer wish to manage this AP, you may remove it. Note that all configurations and history with respect to this AP will be lost.

Forget

6

Manage the Omada Controller

This chapter mainly introduces how to manage the user account and configure system settings. This chapter includes the following contents.

- User Account
- General Setting
- History Data Retention
- Backup&Restore
- Auto Backup
- Migrate
- Information About the Software

6.1 User Account

You can use different user account to log in to the Omada Controller. User has three roles: administrator, operator and observer. The administration authority varies among different roles.

Administrator	The first administrator account is created in the Basic Configuration process and this account can not be deleted. An administrator can change the settings of the EAP network and create and delete user accounts.
Operator	An operator account can be created or deleted by the administrator. The operator can change the settings of the EAP network.
Observer	An observer account can be created or deleted by the administrator. The observer can only view the status and settings of the EAP network but not change the settings.

Follow the steps below to add user account.

1. Go to **Controller Settings > User Account**.

The screenshot shows the Omada Controller web interface. The top navigation bar includes 'Wireless Settings', 'Wireless Control', 'Site Settings', 'Cloud Access', and 'Controller Settings'. The 'Controller Settings' menu is expanded, showing 'User Account' as the selected option. Below the navigation, there is a search bar for 'Username, Email, Role' and an '+ Add' button. A table lists the existing user accounts:

UserName	Email	Role	Created Time	Action
admin	administrator@example.com	administrator	2018-08-03 17:57:15	

At the bottom of the table, there are pagination controls showing '1' of 1 page and a 'GO' button.

2. Click **+ Add** and the following window will pop up.

The 'Add User' dialog box contains the following fields:

- UserName:
- Email: (Optional)
- Role: (with a help icon)
- Password: (with an eye icon)
- Confirm Password: (with an eye icon)
- Site Privileges:

An 'Apply' button is located at the bottom left of the dialog.

3. Specify the username, Email and password of the account.

4. Select the role from the drop-down list.

- If you select **operator** or **observer**, you also need to select the **Site Privileges**.

- If you select **administrator**, the **Site Privileges** option will not appear and all sites are available for the administrator user.

5. Click **Apply** to add the user account.

Note:

- You can refer to the **Role** page to view the user role's type, description information, permission scope and created time.
- The user account cannot be used to log in to the Omada Controller through Omada Cloud Service. To access the controller via Cloud Access, you should be a cloud user. To add a cloud user, refer to [manage the cloud users](#).

6.2 General Setting

6.2.1 Configure Controller Name

Omada Controller is given a default name in the format **Omada Controller_XXXXXX**. You can give your controller a descriptive name in the **Controller Settings > General Setting** page and click **Apply**.

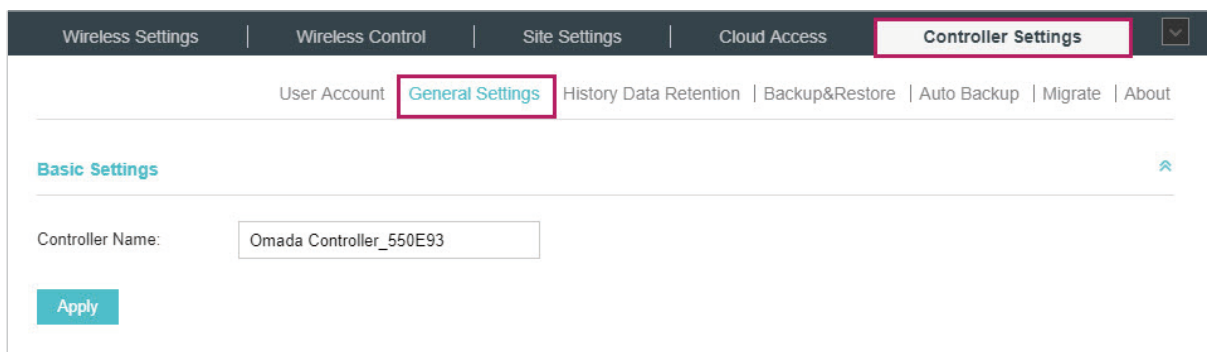

6.2.2 Configure Mail Server

With the Mail Server, you can reset the login password of the user account if necessary. An email with the link of resetting password will be sent from the Omada Controller. It is different from the SMTP Server, which is just for the system log emails sending.

Follow the steps below to configure mail server.

1. Go to **Controller Settings > General Setting** and click **Mail Server**.

Wireless Settings | Wireless Control | Site Settings | Cloud Access | **Controller Settings**

User Account | **General Settings** | History Data Retention | Backup&Restore | Auto Backup | Migrate | About

Basic Settings

Mail Server ?

Controller Hostname/IP:

Enable SMTP Server

Apply

2. Enter the hostname or IP address of the Omada Controller. The default IP address of the Omada Controller is **127.0.0.1**. You can keep it or customize the hostname or IP address which can be visited by the Controller host.

When the email with the link of resetting password are sent out, the Controller hostname or IP address will be specified in the Controller URL in every message.

3. Check the box to enable **SMTP Server**, and then the following screen will appear.

Wireless Settings | Wireless Control | Site Settings | Cloud Access | **Controller Settings**

User Account | **General Settings** | History Data Retention | Backup&Restore | Auto Backup | Migrate | About

Basic Settings

Mail Server ?

Controller Hostname/IP:

Enable SMTP Server

Mail Server:

Port:

Enable SSL

Enable Auth

Username:

Password:

Specify Sender Address:

Apply

4. Configure the following parameters.

Mail Server	Enter the IP address or domain name of SMTP Server.
Port	The SMTP server uses port 25 as default. You can enable SSL (Security Socket Layer) to enhance secure communications over the Internet. If SSL is enabled, the port number will automatically change to 465.
Enable Auth	Check the box to enable authentication (Optional).
Username/Password	If you enable authentication, enter the username and password required by the mail server.
Specify Sender Address	Specify the sender's mail address. Enter the email address that will appear as the sender for resetting password.

5. Click **Apply** to save the configuration.

Note:

Specify the account email address based on the Mail server to receive the email for resetting password.

6.3 History Data Retention

History Data Retention allows users to determine the retention of logs and client statistics. The logs and client statistics beyond the specified number of days will be cleared. For example, with **7 days** selected, only the logs and client statistics in recent 7 days will be retained, and the data beyond 7 days will be cleared from the controller.

Follow the steps below to configure Historical Data Retention:

1. Go to **Controller Settings > History Data Retention**.

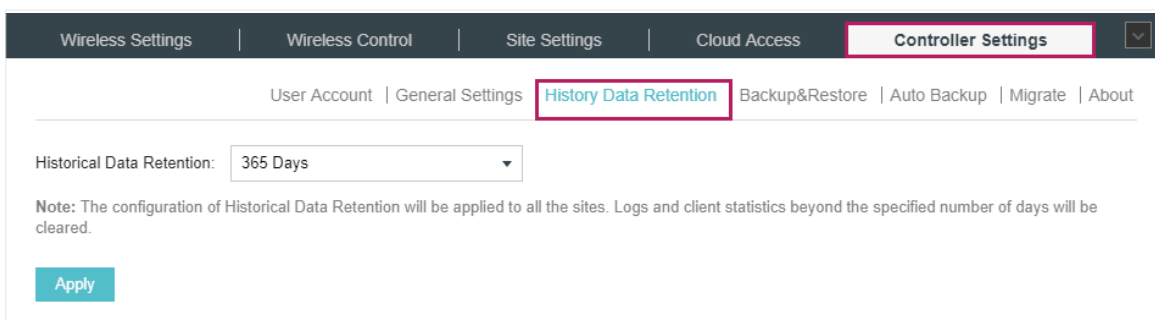

2. Select the length of time in days that data will be retained from the drop-down list. Seven options are provided: **7 days, 30 days, 60 days, 90 days, 180 days, 365 days, or All time**.

3. Click **Apply**.

6.4 Backup&Restore

You can save the current configuration and data in the controller as a backup file and if necessary, restore the configuration using the backup file. We recommend that you back up the settings before upgrading the device. This function is available only for local logged-in users.

Follow the steps below to backup and restore the configuration.

1. Go to **Controller Settings > Backup&Restore**.

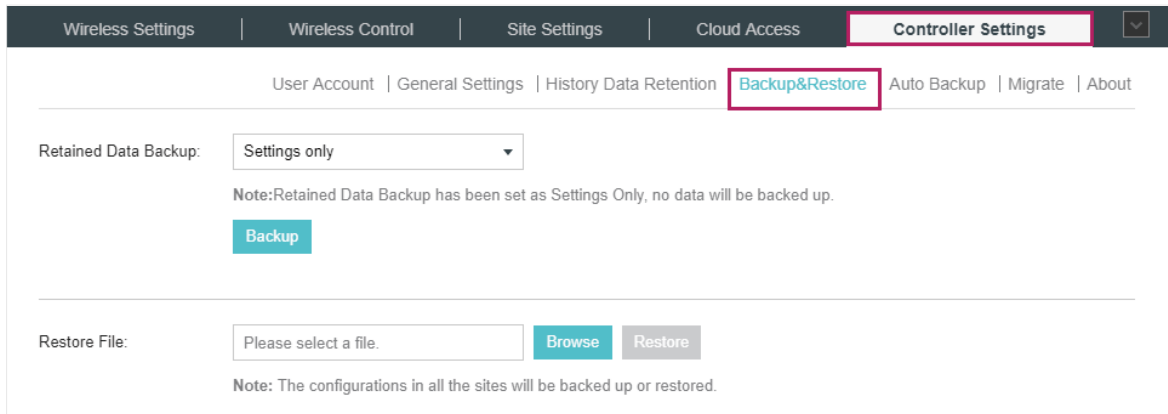

The screenshot shows the 'Controller Settings' page with the 'Backup&Restore' sub-menu highlighted. The page contains the following elements:

- Navigation tabs: Wireless Settings, Wireless Control, Site Settings, Cloud Access, **Controller Settings** (selected), and a dropdown arrow.
- Sub-menu items: User Account, General Settings, History Data Retention, **Backup&Restore** (highlighted), Auto Backup, Migrate, and About.
- 'Retained Data Backup' section: A dropdown menu currently set to 'Settings only'. Below it is a note: 'Note: Retained Data Backup has been set as Settings Only, no data will be backed up.' and a blue 'Backup' button.
- 'Restore File' section: A text input field with the placeholder 'Please select a file.', a blue 'Browse' button, and a grey 'Restore' button. Below it is a note: 'Note: The configurations in all the sites will be backed up or restored.'

2. Select the length of time in days that data will be backed up in the **Retained Data Backup** drop-down list. For example, with **7 days** selected, the data only in recent 7 days will be backed up.
3. Click **Backup** to save the backup file.
4. If necessary, click **Browse** to locate and choose the backup file. Then click **Restore** to restore the configuration.

Note:

- If you do not want to back up historical data, you can select **Settings only** to get only the controller setting saved in the backup files.
- If you do not want to back up data manually, you can enable the **Auto Backup** function. Please refer to [Auto Backup](#).
- To keep the backup data safe, please wait without any operations while restoring the backup file.

6.5 Auto Backup

With Auto Backup enabled, the controller will be scheduled to back up the configuration and data automatically at the specified time.

Follow the steps below to configure Auto Backup function.

1. Go to **Controller Settings > Auto Backup**.

Wireless Settings | Wireless Control | Site Settings | Cloud Access | **Controller Settings** | ⌵

User Account | General Settings | History Data Retention | Backup&Restore | **Auto Backup** | Migrate | About

Auto Backup: Enable

Occurrence: Daily ▾

Backup Time: 00 ▾ : 00 ▾

Retained Data Backup: Settings only ▾

Note: Retained Data Backup has been set as Settings Only, no data will be backed up.

Maximum Number of Files: 7 (1-50)

Apply



Backup Files List ⌵

2. Check the box to enable Auto Backup function.
3. Select how often to perform Auto Backup in the **Occurrence**. You can choose **Daily**, **Weekly**, **Monthly** or **Yearly** from drop-down list. Then set an appropriate time to back up files in the **Backup Time**.

Note: When you choose the Occurrence as Monthly, please carefully choose the backup date in Backup Time. For example, if you choose to automatically backup the data on the 31th day of every month. When it comes to June, which is only 30 days long, the auto backup will not take effect
4. Select the length of time in days that data will be backed up in the **Retained Data Backup**. For example, with **7 days** selected, the data only in recent 7 days will be backed up.
5. Specify the maximum number of backup files to save in the **Maximum Number of Files**. The default is 7.

You can view the name, backup time and size of the backup files in the **Backup Files List**.

The screenshot shows the 'Controller Settings' page with the 'Auto Backup' section. The 'Auto Backup' checkbox is checked and labeled 'Enable'. The 'Occurrence' is set to 'Weekly'. The 'Backup Time' is set to 'Tue' at '16:30'. The 'Retained Data Backup' is set to '7 Days'. A note states: 'Note: Retained Data Backup has been set as 7 days, data only in recent 7 days will be backed up.' The 'Maximum Number of Files' is set to '7' (1-50). An 'Apply' button is visible. Below the settings is the 'Backup Files List' section, which contains a table with the following data:

File Name	Backup Time	Size	Action
autobackup_7days_20180821_1630.cfg	08/21/2018 16:30	3 KB	  

Below the table is a pagination control showing '<< < 1 > >>' and 'A total of 1 page(s) Page to: [] GO'.

You can execute the corresponding operation to the backup files by clicking an icon in the Action column.



Restore the data and configurations in the backup file.



Download the backup file.



Delete the backup file.

Note:

- To back up data manually and restore the data to the controller, configure **Backup&Restore** function. Please refer to [Backup&Restore](#).
- If you do not want to back up historical data, you can select **Settings only** to get only the controller setting saved in the backup files.
- The auto backup files will be stored in data/ autobackup folder of the controller installation location.
- The configuration of the cloud users will not be backed up. Thus the configuration of the cloud users cannot be restored. To add cloud users, please refer to [Manage the Cloud Users](#).
- To keep the backup data safe , please wait without any operations while restoring the backup file.

6.6 Migrate

Migrate function allows users to migrate the configurations and data to any other site or controller.

For Migrating all the configurations and data from the current controller to any other controller, refer to [Controller Migrate](#).

For Migrating the configurations and data from the existing site to any other controller, refer to [Site Migrate](#).

6.6.1 Controller Migrate

With Controller Migrate function, you can migrate your configurations and data from the current controller to any other controller that has the same or higher version.

The process of migrating configurations and data from the current controller to another controller can be summarized in three steps: Export Controller, Migrate Controller and Migrate Devices.

Follow the steps below to migrate your controller.

Note:

The connection to internet will be lost for several minutes during the migration. Clients need to connect the wireless network again after the migration is completed. Please choose the time to start migration operation carefully.

■ Export Controller

1. Go to **Controller Settings > Migrate > Controller Migrate**.

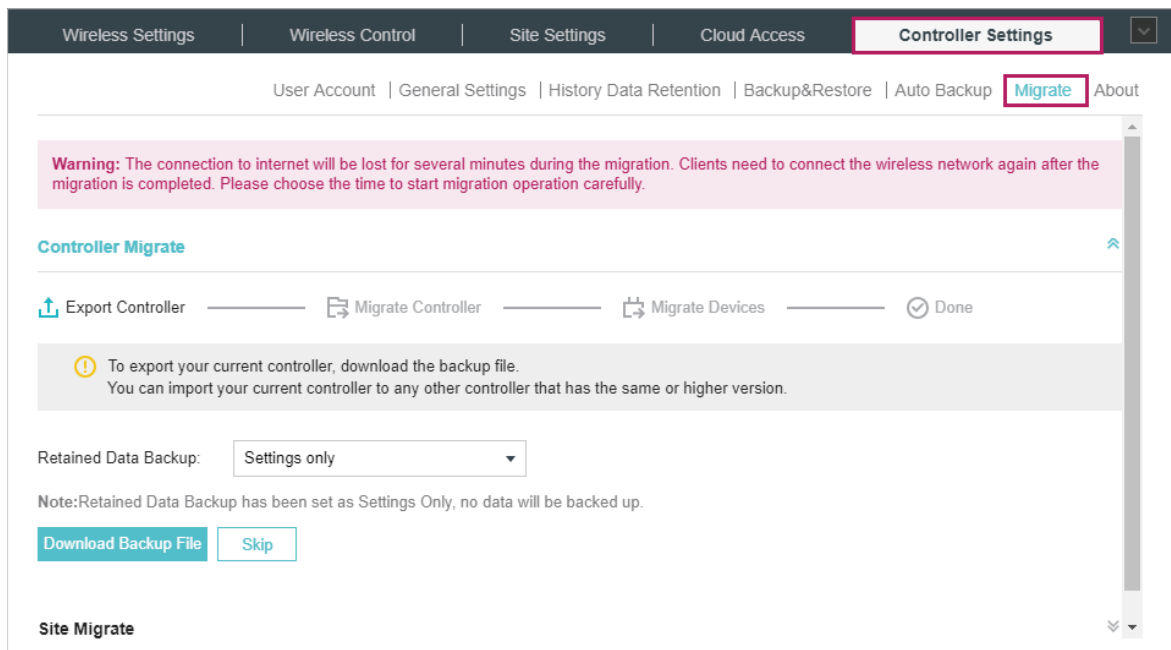

2. Select the length of time in days that data to be imported into the second controller in the **Retained Data Backup** drop-down list. For example, with **7 days** selected, the data only in recent 7 days will be imported into the second controller.

3. Click **Download Backup File** to download the file of the current controller. If you have backed up the file, click **Skip**.

■ Migrate Controller

1. Start and log in to the second controller, go to **Controller Settings > Backup&Restore > Restore File**.

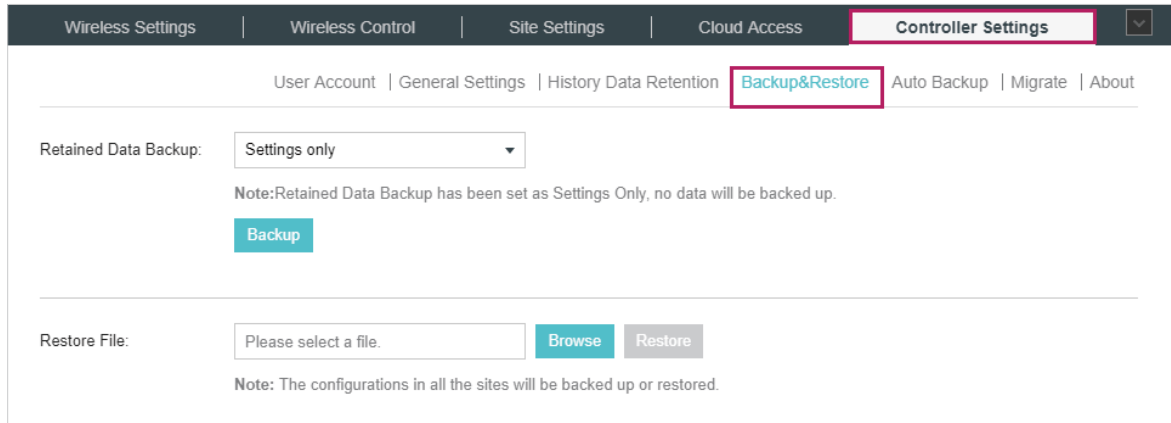

2. Click **Browse** to locate and choose the file of your controller to be imported. Then click **Restore** to upload the file.

3. After the file has been restored to the second controller, go back to the export controller and click **Confirm**.

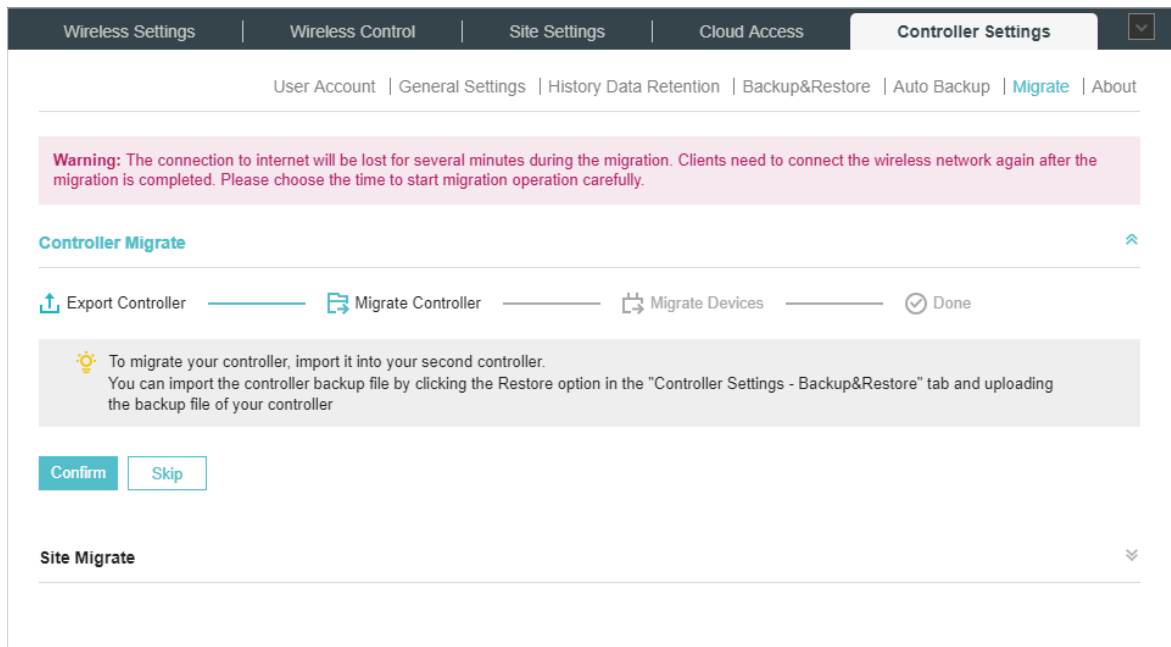

■ Migrate Devices

1. Click **Browse** to locate and choose the file of your controller to be imported. Then click **Restore** to upload the file.

2. Enter the IP address or URL of your second controller into **Controller URL/IP** input field. In this case, the IP address of the second controller is 10.0.3.23.

Wireless Settings | Wireless Control | Site Settings | Cloud Access | **Controller Settings**

User Account | General Settings | History Data Retention | Backup&Restore | Auto Backup | [Migrate](#) | About

Warning: The connection to internet will be lost for several minutes during the migration. Clients need to connect the wireless network again after the migration is completed. Please choose the time to start migration operation carefully.

Controller Migrate

Export Controller — Migrate Controller — Migrate Devices — Done

⚠ Migrate the selected devices to your second controller. Please provide the Inform URL to your second controller.

Controller URL/IP:

Note:

Make sure that you enter the correct IP address of the second controller to establish the communication between EAPs and your second controller. Otherwise the EAPs cannot be adopted by the second controller.

3. Select the devices that are to be migrated by clicking the boxes next to each devices. By default, all the devices are selected.

Wireless Settings | Wireless Control | Site Settings | Cloud Access | **Controller Settings**

User Account | General Settings | History Data Retention | Backup&Restore | Auto Backup | [Migrate](#) | About

Warning: The connection to internet will be lost for several minutes during the migration. Clients need to connect the wireless network again after the migration is completed. Please choose the time to start migration operation carefully.

Controller Migrate

Export Controller — Migrate Controller — Migrate Devices — Done

⚠ Migrate the selected devices to your second controller. Please provide the Inform URL to your second controller.

Controller URL/IP:

<input checked="" type="checkbox"/>	↕ Device Name	↕ Site	↕ Status	↕ Model	↕ Hardware Version
<input checked="" type="checkbox"/>	EA-23-51-06-22-52	Default	Connected	EAP225-Outdoor(EU)	1.0
<input checked="" type="checkbox"/>	EA-33-51-A8-22-A0	Default	Connected	EAP225-Outdoor(EU)	1.0

Selected 2 of 2 items. << < 1 > >> A total of 1 page(s) Page to: **GO**

Migrate Devices

4. Click **Migrate Devices** to migrate the selected devices to the second controller.

- Verify that all the migrated devices are visible and connected on the second controller. Note that this may take several minutes. When all the migrated devices are in **Connected** status on the **Access Points** page on the second controller, click **Forget Devices** to finish the migration process.

The screenshot shows the 'Controller Settings' page with a navigation menu at the top including 'Wireless Settings', 'Wireless Control', 'Site Settings', 'Cloud Access', and 'Controller Settings'. Below the menu is a breadcrumb trail: 'User Account | General Settings | History Data Retention | Backup&Restore | Auto Backup | [Migrate](#) | About'. A warning message states: 'To finish the migration process, forget the successfully migrated devices. Please visit the device page in your second controller and check if all of the migrated devices are visible and connected. This process may take several minutes.' Below the warning is a search bar for 'Device Name, Model'. A table lists two devices:

<input checked="" type="checkbox"/>	↕ Device Name	↕ Site	↕ Status	↕ Model	↕ Hardware Version
<input checked="" type="checkbox"/>	EA-23-51-06-22-52	Default	Connected	EAP225-Outdoor(EU)	1.0
<input checked="" type="checkbox"/>	EA-33-51-A8-22-A0	Default	Connected	EAP225-Outdoor(EU)	1.0

Below the table, it says 'Selected 2 of 2 items.' and 'A total of 1 page(s) Page to: GO'. At the bottom, there are two buttons: 'Forget Devices' and 'Skip'.

When the migration process is completed, all the configuration and data are migrated to the second controller. You can uninstall the previous controller if necessary.

The screenshot shows the 'Controller Settings' page with the same navigation menu. The breadcrumb trail is 'User Account | General Settings | History Data Retention | Backup&Restore | Auto Backup | [Migrate](#) | About'. A warning message states: 'Warning: The connection to internet will be lost for several minutes during the migration. Clients need to connect the wireless network again after the migration is completed. Please choose the time to start migration operation carefully.' Below the warning is a section titled 'Controller Migrate' with a progress bar showing four steps: 'Export Controller', 'Migrate Controller', 'Migrate Devices', and 'Done'. Below the progress bar is another warning message: 'To finish the migration process, forget the successfully migrated devices. Please visit the device page in your second controller and check if all of the migrated devices are visible and connected. This process may take several minutes.' Below the warning is a search bar for 'Device Name, Model'. A table header is visible, but the table is empty with the text 'No entry in the table.' below it.

<input type="checkbox"/>	↕ Device Name	↕ Site	↕ Status	↕ Model	↕ Hardware Version
No entry in the table.					

Below the table, it says 'Selected 0 of 0 items.' and 'A total of NaN page(s) Page to: GO'.

6.6.2 Site Migrate

With Site Migrate function, you can migrate your configurations and data of a site to any other controller that has the same version.

The process of migrating configurations and data from a site to another controller can be summarized in three steps: Export Site, Migrate Site and Migrate Devices.

Follow the steps below to migrate a site to another controller.

Note:

The connection to internet will be lost for several minutes during the migration. Clients need to connect the wireless network again after the migration is completed. Please choose the time to start migration operation carefully.

■ Export Site

1. Go to **Controller Settings > Migrate > Site Migrate**.

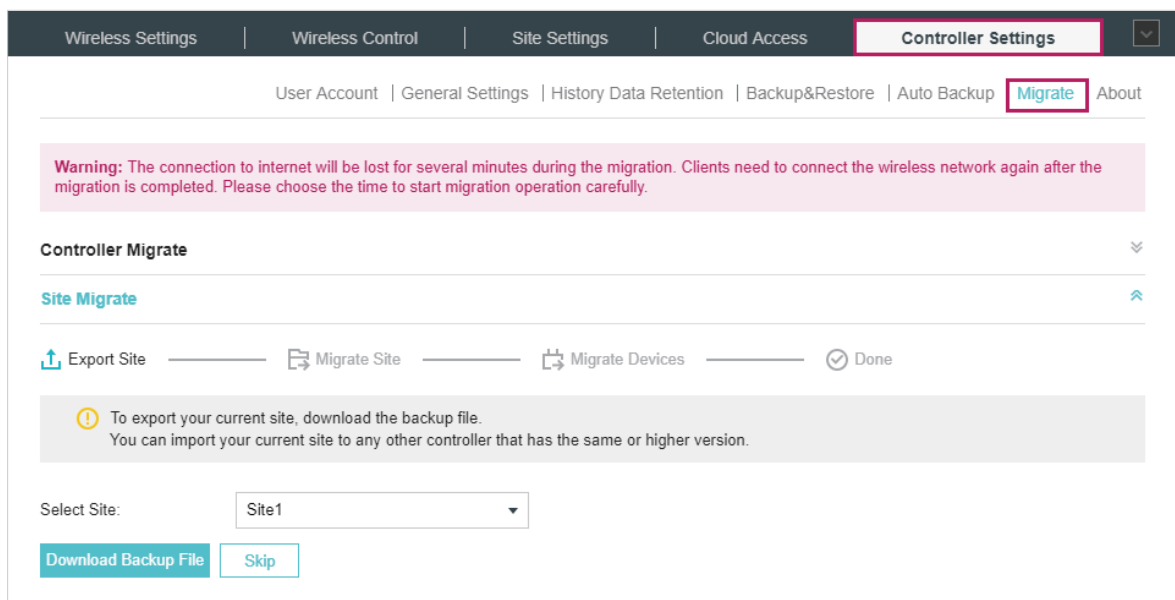



2. Select the site to be imported into the second controller in the **Select Site** drop-down list.







3. Click **Download Backup File** to download the file of the current site. If you have backed up the file, click **Skip**.

■ Migrate Site

1. Start and log in to the second controller, click **Sites: Default** in the top left corner of the page and select **Site Manager**, and then the following window will pop up.

Site Management ✕

Site Name
 Import Site
  Add

↕ Site Name	↕ Alerts	↕ Connected	↕ Disconnected	↕ Isolated	↕ Users	↕ Guests	Action
Default	0	0	0	0	0	0	
Site1	0	0	0	0	0	0	  
Site2	0	0	0	0	0	0	  

<< < 1 > >> A total of 1 page(s) Page to: **GO**

2. Click  **Import Site** and enter a unique name for the new site.

Import Site ✕

Site Name:

Choose File: **Browse** **Import**

3. Click **Browse** to upload the file of the site to be imported and click **Import** to import the site.

Import Site ✕

Site Name:

Choose File: **Browse** **Import**

4. After the file has been imported to the second controller, go back to the export controller and click **Confirm**.

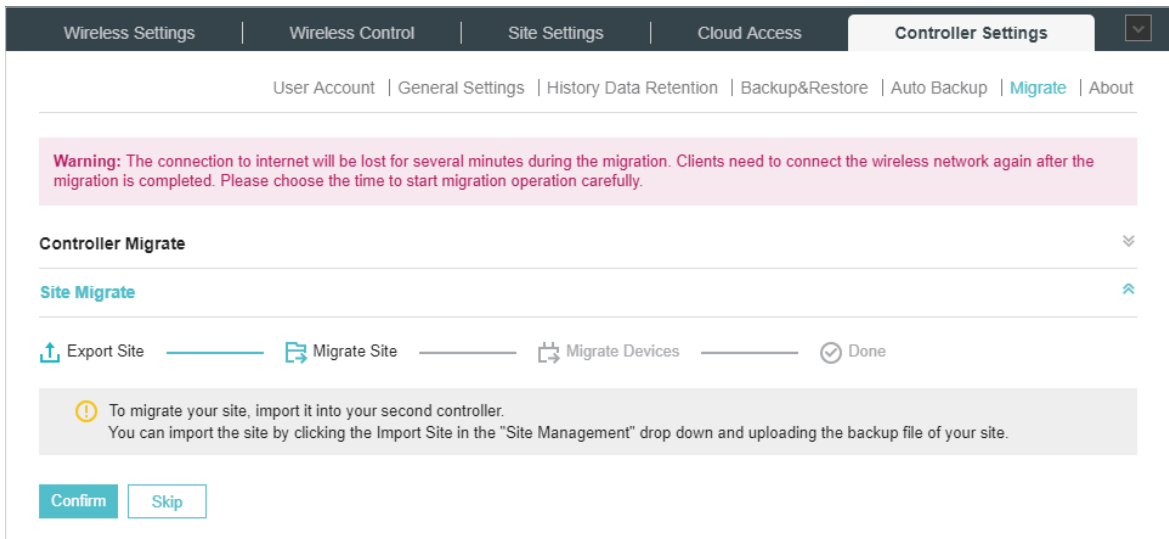

■ Migrate Devices

1. Enter the IP address or URL of your second controller into **Controller URL/IP** input field. In this case, the IP address of the second controller is 10.0.3.14.

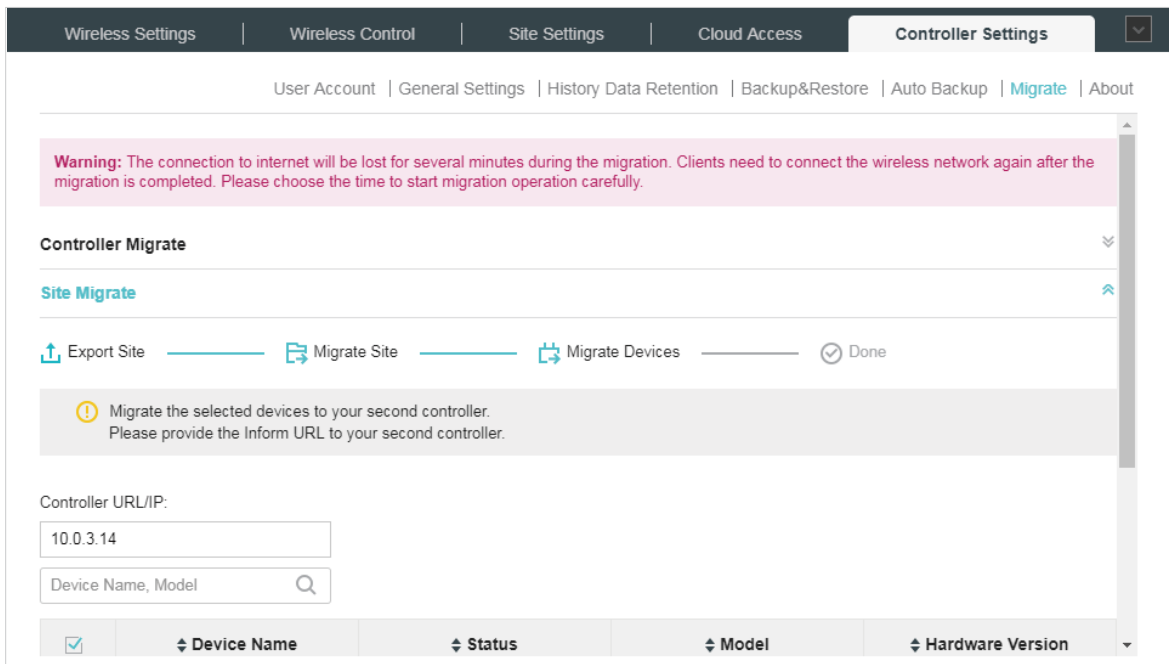

Note:

Make sure that you enter the correct IP address of the second controller to establish the communication between EAPs and your second controller. Otherwise the EAPs cannot be adopted by the second controller.

2. Select the devices that are to be migrated by clicking the boxes next to each devices. By default, all the devices are selected.

Warning: The connection to internet will be lost for several minutes during the migration. Clients need to connect the wireless network again after the migration is completed. Please choose the time to start migration operation carefully.

Controller Migrate

Site Migrate

Export Site — Migrate Site — Migrate Devices — Done

ⓘ Migrate the selected devices to your second controller. Please provide the Inform URL to your second controller.

Controller URL/IP:

Device Name, Model

<input checked="" type="checkbox"/>	↕ Device Name	↕ Status	↕ Model	↕ Hardware Version
<input checked="" type="checkbox"/>	EA-23-51-06-22-52	Connected	EAP225-Outdoor(EU)	1.0
<input checked="" type="checkbox"/>	EA-33-51-A8-22-A0	Connected	EAP225-Outdoor(EU)	1.0

Selected 2 of 2 items. << < 1 > >> A total of 1 page(s) Page to: **GO**

3. Click **Migrate Devices** to migrate the selected devices to the second controller.
4. Verify that all the migrated devices are visible and connected on the second controller. Note that this may take several minutes. When all the migrated devices are in **Connected** status on the **Access Points** page on the second controller, click **Forget Devices** to finish the migration process.

ⓘ To finish the migration process, forget the successfully migrated devices. Please visit the device page in your second controller and check if all of the migrated devices are visible and connected. This process may take several minutes.

Device Name, Model

<input checked="" type="checkbox"/>	↕ Device Name	↕ Site	↕ Status	↕ Model	↕ Hardware Version
<input checked="" type="checkbox"/>	EA-23-51-06-22-52	Default	Connected	EAP225-Outdoor(EU)	1.0
<input checked="" type="checkbox"/>	EA-33-51-A8-22-A0	Default	Connected	EAP225-Outdoor(EU)	1.0

Selected 2 of 2 items. << < 1 > >> A total of 1 page(s) Page to: **GO**

Forget Devices

When the migration process is completed, all the configuration and data are migrated to the second controller. You can delete the previous site if necessary.

The screenshot shows the 'Controller Settings' page in the Omada web interface. The navigation bar includes 'Wireless Settings', 'Wireless Control', 'Site Settings', 'Cloud Access', and 'Controller Settings'. Below the navigation bar, there are links for 'User Account', 'General Settings', 'History Data Retention', 'Backup&Restore', 'Auto Backup', 'Migrate', and 'About'. A warning message states: 'Warning: The connection to internet will be lost for several minutes during the migration. Clients need to connect the wireless network again after the migration is completed. Please choose the time to start migration operation carefully.' The 'Controller Migrate' section is expanded, showing 'Site Migrate' and a progress bar with steps: 'Export Site', 'Migrate Site', 'Migrate Devices', and 'Done'. A note below the progress bar says: 'To finish the migration process, forget the successfully migrated devices. Please visit the device page in your second controller and check if all of the migrated devices are visible and connected. This process may take several minutes.' There is a search box for 'Device Name, Model' and a table with columns: 'Device Name', 'Status', 'Model', and 'Hardware Version'. The table currently contains the text 'No entry in the table.'

6.7 Information About the Software

You can view the Omada Controller's version and copyright information on the **Controller Settings** > **About** page.

The screenshot shows the 'About' page within the 'Controller Settings' section. The navigation bar is the same as in the previous screenshot, with 'Controller Settings' highlighted. Below the navigation bar, there are links for 'User Account', 'General Settings', 'History Data Retention', 'Backup&Restore', 'Auto Backup', 'Migrate', and 'About'. The main content area displays the following information: 'Version: 3.1.13', 'Copyright © 2013-2019 TP-Link Technologies Co., Ltd.', and 'All rights reserved.'

7

Application Example

A restaurant has a wireless network with three EAPs managed by the Omada Controller. The network administrator wants to :

- Monitor the EAPs with the Map.
- Enable Portal function to drive customers' attention to the ads of the supermarket when customers attempt to access the network. The costumers need to use a simple password to pass the authentication.
- Allow the employees of the restaurant to access the network resources without portal authentication.
- Schedule the radio to operate only during the working time (8:00 am to 22:00 pm) in order to reduce power consumption.

Follow the steps below to achieve the requirements above.

7.1 Basic Configuration

Follow the steps below to do the basic configuration.

1. Connect the hardware by referring to the following topology.

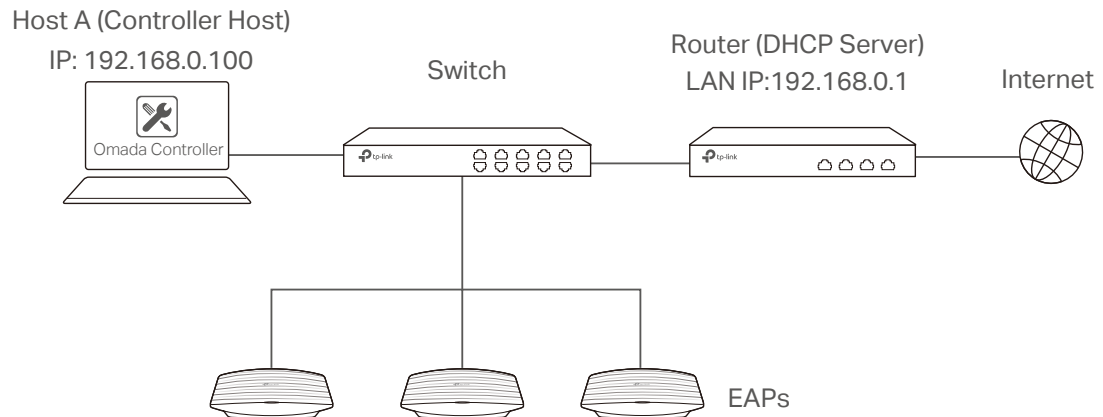

2. Install the Omada Controller on Host A.
3. Launch the software and follow the instructions to complete some initial configurations.
4. Log into the management interface.
5. Adopt the pending EAPs.

7.2 Advanced Settings

After the basic configuration, refer to the following content to meet the network administrator's requirements.

7.2.1 Monitor the EAPs with Map

Follow the steps below to create a map and monitor the EAPs with the map.

1. Go to the **Map**.
2. Import a local map and set the map scale.
3. Drag the EAPs to the appropriate locations on the map.
4. Click **Coverage** and you can see the representation of the EAPs' wireless coverage.



7.2.2 Configure Portal Authentication

Follow the steps below to configure Portal function.

1. Go to **Wireless Settings > Basic Wireless Settings** and edit the SSID we created in the basic configuration.

Edit SSID ✕

Basic Info ⤴

SSID Name:

Band: 2.4GHz 5GHz

Guest Network: Enable ?

Security Mode: ▼

Advanced Settings ⤵

Apply

To make it easier for customers to connect, change the Security Mode from **WPA-PSK** to **None**. Customers can connect to the EAPs without password and be redirected to the Portal Authentication where the correct password will be required.

2. Open the global configuration window and go to **Wireless Control > Portal**. Click  **Add a New Portal**. The configuration window will pop up.
3. In the **Basic Info** section, complete the basic settings for the portal.

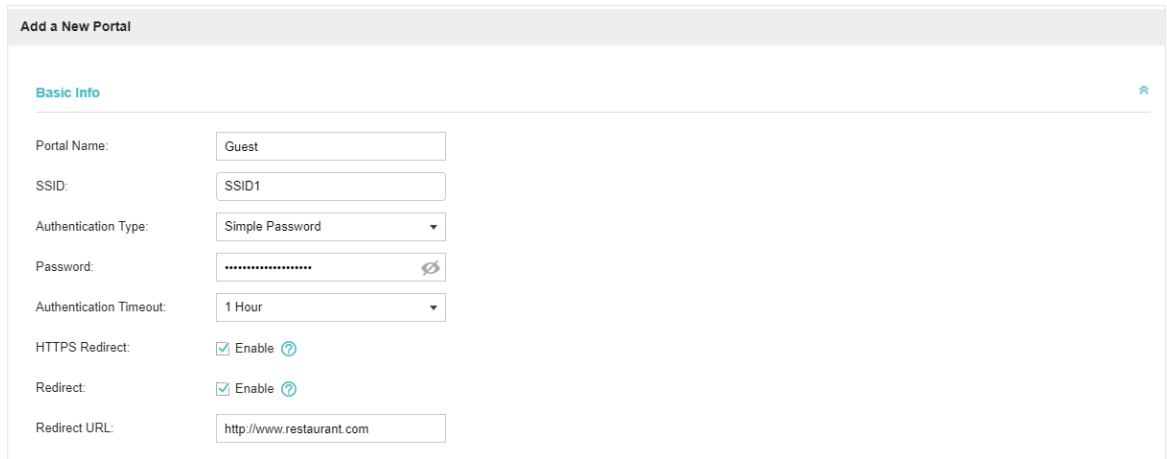

Add a New Portal

Basic Info

Portal Name:

SSID:

Authentication Type:

Password:

Authentication Timeout:

HTTPS Redirect: Enable

Redirect: Enable

Redirect URL:

- 1) Specify a name for the portal.
 - 2) Select an SSID for the portal.
 - 3) Select the Authentication Type as Simple Password. Specify a simple password for the guests.
 - 4) Select the **Authentication Timeout**. For example, 1 Hour is suitable for the customers at the restaurant.
 - 5) Enable the **Redirect** to drive the costumers to the restaurant's homepage after successful login. We can put some promotion information on the page.
4. In the **Login Page** section, configure the login page.

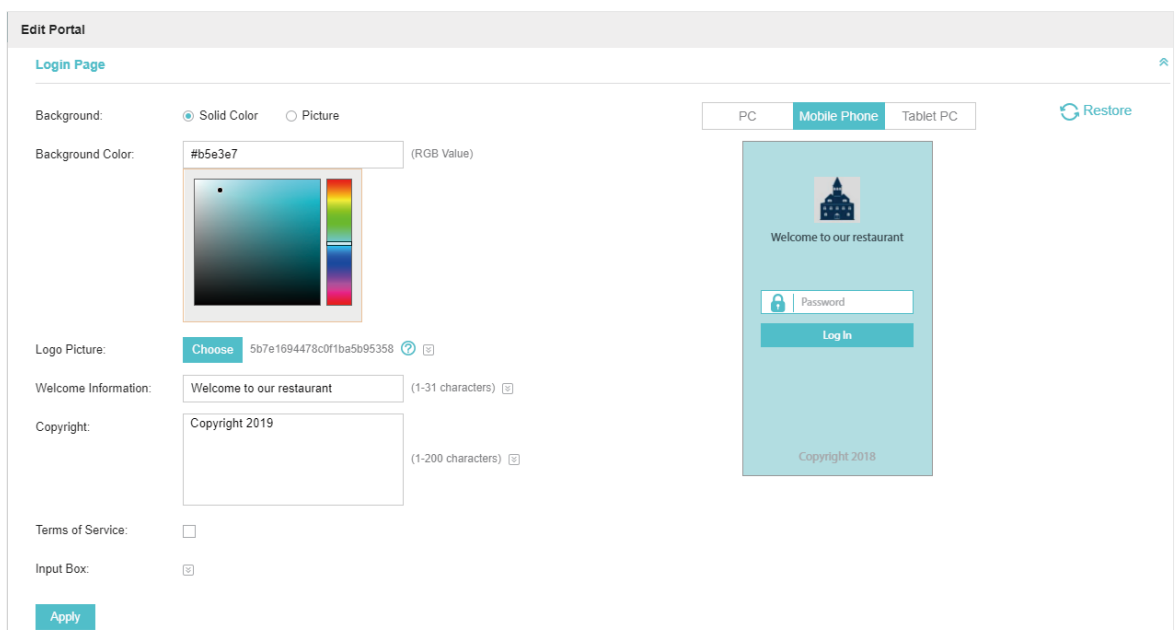

Edit Portal

Login Page

Background: Solid Color Picture

Background Color: (RGB Value)

Logo Picture: 5b7e1694478c0f1ba5b95358

Welcome Information: (1-31 characters)

Copyright: (1-200 characters)

Terms of Service:

Input Box:

PC **Mobile Phone** Tablet PC

Welcome to our restaurant

Copyright 2018

5. In the Advertisement section, upload two pictures of the restaurant and set the related parameters.

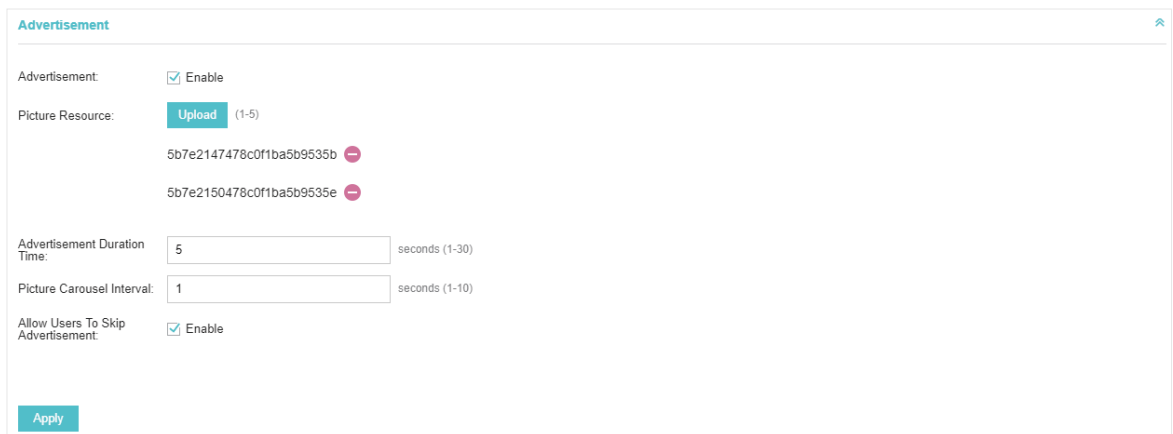

The screenshot shows the 'Advertisement' configuration window. It includes the following settings:

- Advertisement:** Enable
- Picture Resource:** (1-5)
 - 5b7e2147478c0f1ba5b9535b
 - 5b7e2150478c0f1ba5b9535e
- Advertisement Duration Time:** seconds (1-30)
- Picture Carousel Interval:** seconds (1-10)
- Allow Users To Skip Advertisement:** Enable

6. Click **Apply**.

7.2.3 Create a SSID for the Employees

We have created a SSID in the basic configuration for the customers. Here we need to create another SSID for the employees to allow them to access the network without portal authentication. In addition, the new SSID should be invisible for the customers.

Follow the steps below to create a SSID for the employees.

1. Open the global configuration window and go to **Wireless Settings > Basic Wireless Settings**.
2. Click **Add** to add a new SSID.

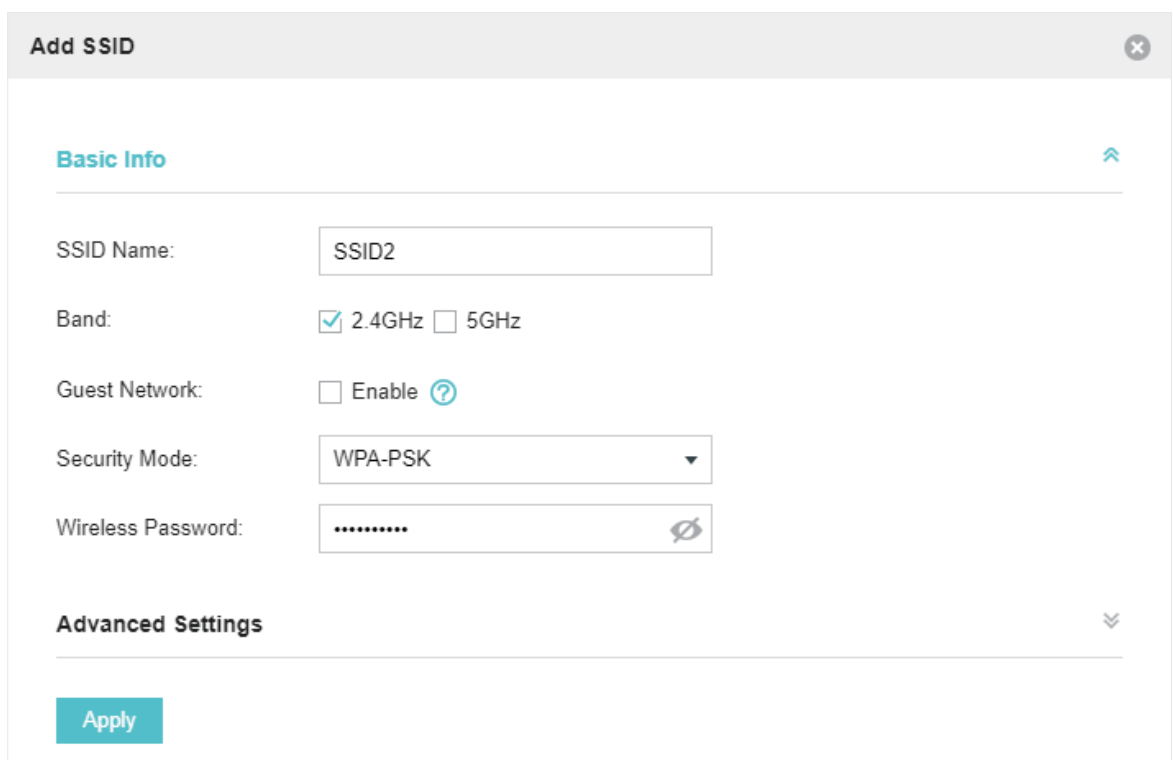

The screenshot shows the 'Add SSID' configuration window. It includes the following settings:

- SSID Name:**
- Band:** 2.4GHz 5GHz
- Guest Network:** Enable
- Security Mode:** ▼
- Wireless Password:**

Advanced Settings ▼

Configure the parameters.

- 1) Disable the **SSID Broadcast** to hide this SSID from the customers.
- 2) Specify the **SSID Name**, **Security Mode** and **Wireless Password**. Let the employees manually enter the SSID name and password, and choose the security mode you set to access the network.
- 3) Click **Apply** to save the configuration.

7.2.4 Configure Scheduler

Follow the steps below to schedule the radio to operate only during the working time (from 8:00 to 22:00).

1. Open the global configuration window and go to **Wireless Control > Scheduler**.
 - 1) Add a profile.

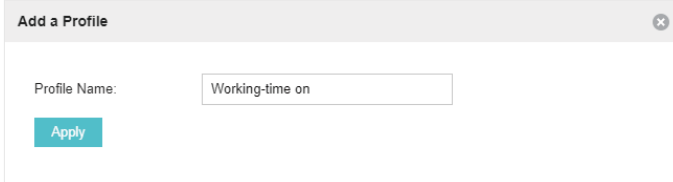

The screenshot shows a dialog box titled "Add a Profile". It has a close button (X) in the top right corner. Inside the dialog, there is a label "Profile Name:" followed by a text input field containing the text "Working-time on". Below the input field is a blue button labeled "Apply".

- 2) Add an item for the profile. The parameters are set as shown on the following screen.

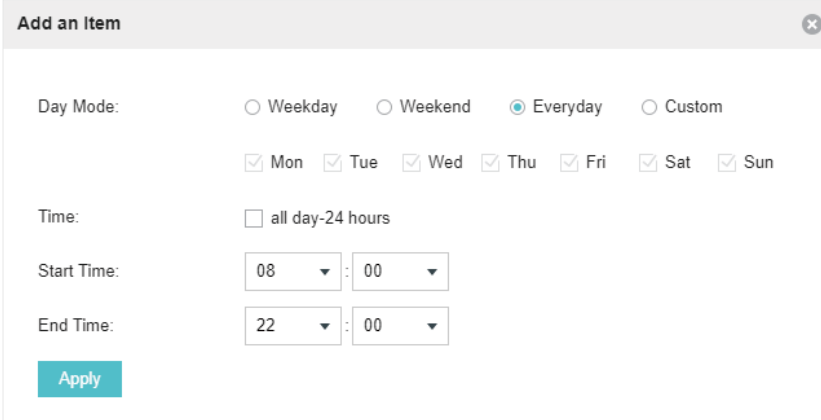

The screenshot shows a dialog box titled "Add an Item". It has a close button (X) in the top right corner. The "Day Mode:" section has four radio buttons: "Weekday", "Weekend", "Everyday" (which is selected), and "Custom". Below this, there are seven checkboxes for the days of the week: "Mon", "Tue", "Wed", "Thu", "Fri", "Sat", and "Sun", all of which are checked. The "Time:" section has a checkbox labeled "all day-24 hours" which is unchecked. Below this, there are two time selection fields: "Start Time:" with a dropdown set to "08" and a time dropdown set to "00", and "End Time:" with a dropdown set to "22" and a time dropdown set to "00". At the bottom of the dialog is a blue button labeled "Apply".

2. Go to **Scheduler Association** tab.

Wireless Settings | **Wireless Control** | Site Settings | Cloud Access | Controller Settings

Access Control | Portal | Free Authentication Policy | MAC Filter | MAC Filter Association | Scheduler | **Scheduler Association** | QoS

Scheduler: Enable

Association Mode: Associated with SSID

Apply

2.4GHz 5GHz Default

ID	SSID Name	Band	Profile Name	Action	Setting
1	SSID1	2.4GHz	Working-time on	Radio On	Apply
2	SSID2	2.4GHz	Working-time on	Radio On	Apply

<< < 1 > >> A total of 1 page(s) Page to: GO

- 1) Enable the function and select **Associated with SSID**. Click **Apply**.
- 2) In the **Profile Name** column of both SSIDs, select the profile we just created.
- 3) In the **Action** column of both SSIDs, select **Radio On**.
- 4) Click **Apply** in the **Setting** column of both SSIDs.
- 5) Select **5GHz** and do the same configurations as above.

Appendix: Omada App

Omada app is a mobile application designed for Omada series EAP products. It allows you to conveniently monitor and manage your network. The Omada app can be used for Standalone and Controller modes.

This appendix introduces how to use Omada app to manage your network and includes the following sections:

- **Install Omada App on the Mobile Device**
- **Manage your Network in Standalone Mode**
- **Manage your Network in Controller Mode**

1 Install Omada App on the Mobile Device

Omada app runs on iOS and Android devices, such as smart phones and tablets. Launch the Apple App Store (iOS) or Google Play store (Android) and search “TP-Link Omada” or simply scan the QR code to download and install the app.



2 Manage your Network in Standalone Mode

For a relatively small-scale network which has a few EAPs (usually less than three) and only basic functions are required, standalone mode is recommended. You can use a mobile device to configure each EAP individually for basic functionality without configuring a Omada Controller. Note that the EAP which is managed by Omada Controller is inaccessible in standalone mode.

Refer to the topology below, make sure that the following requirements have been met:

- An Ethernet connection from your Omada EAP to the LAN with a DHCP server.
- The supported firmware version of the EAP. EAP245, EAP225, EAP115, EAP110, EAP225-Outdoor, EAP110-Outdoor, EAP115-Wall and EAP225-Wall are currently supported. To check the firmware versions of the supported EAPs, please refer to www.tp-link.com/omada_compatibility_list. More products will be supported by Omada app in the near future as firmware updates are released.
- A compatible iOS or Android device with Omada app.

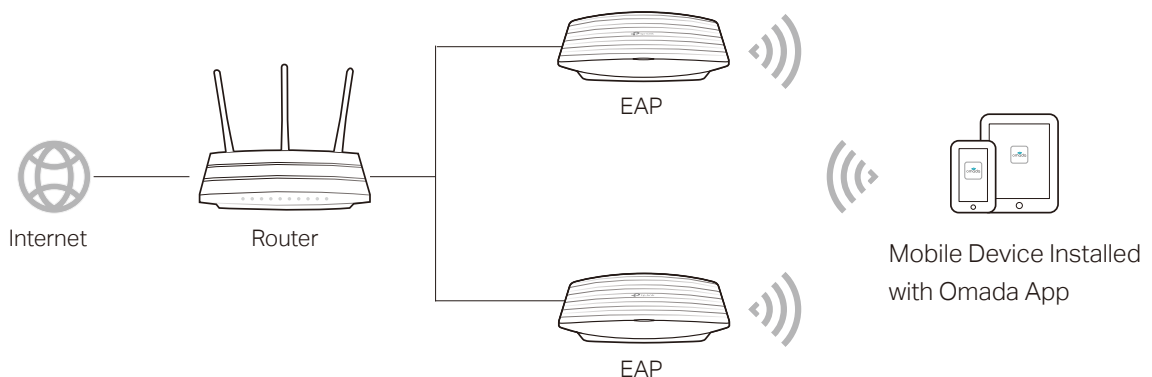

Follow the steps below to manage your network via Omada app in standalone mode. The following page is exemplified with the iOS version of the app. The Android version is similar.

1. Connect your mobile device to the EAP by using the default SSID (format: TP-Link 2.4GHz/5GHz_XXXXXX) printed on the label.



2. Launch the Omada app, tap **Standalone APs** and wait for the EAP device to be discovered.

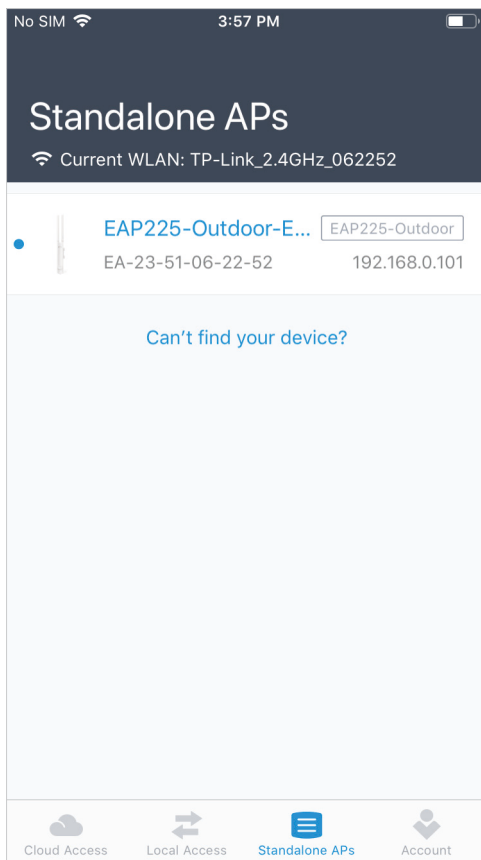

Tips:

All the EAP devices in the same subnet will be discovered by Omada app and shown on the page. You can tap the discovered EAP device to configure directly.

3. Tap on the EAP device appearing on the page. Set a new username and password for your login account of the EAP.

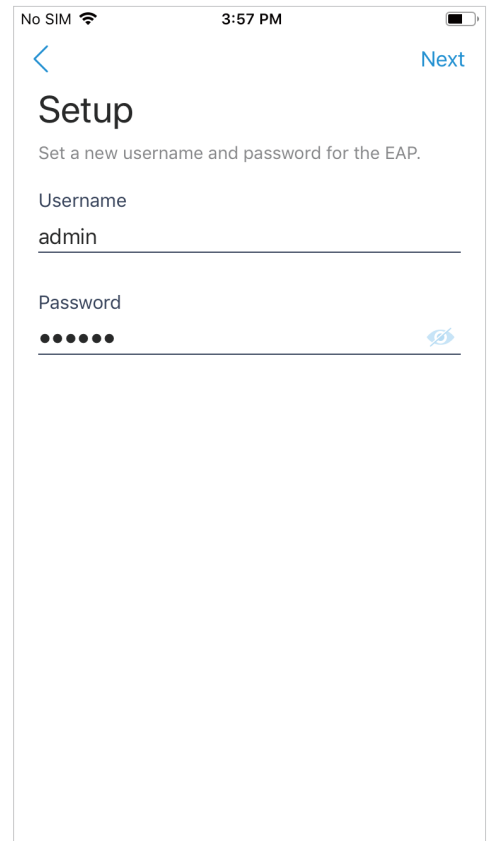

4. Edit the default SSID and password to keep your wireless network secure. Tap **Next**.

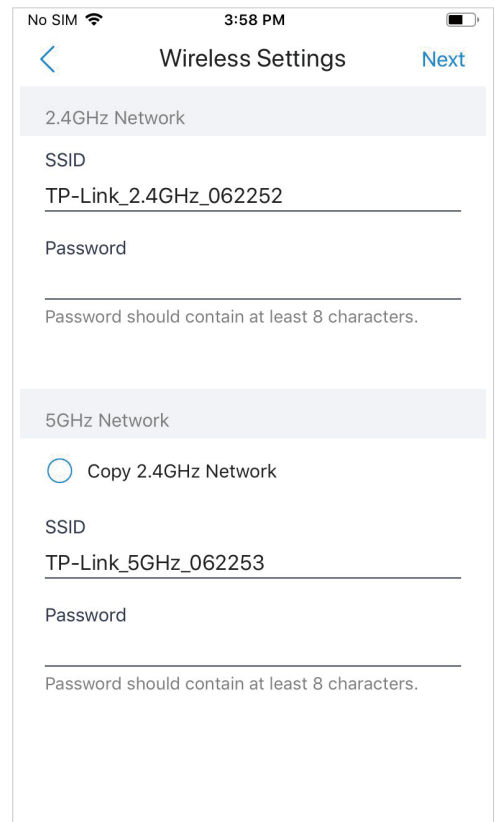

Note:

The settings will take effect after several minutes. For operation system differences, the wireless network connection will be different. When the default SSID of the EAP device is changed, normally mobile device join the new wireless network automatically. For the unsupported operation system, you should manually connect to the new SSID.

5. You can view the name of the EAP device and other information including wireless parameters and clients. And you can tap  to change the settings of radio, SSID and device account.

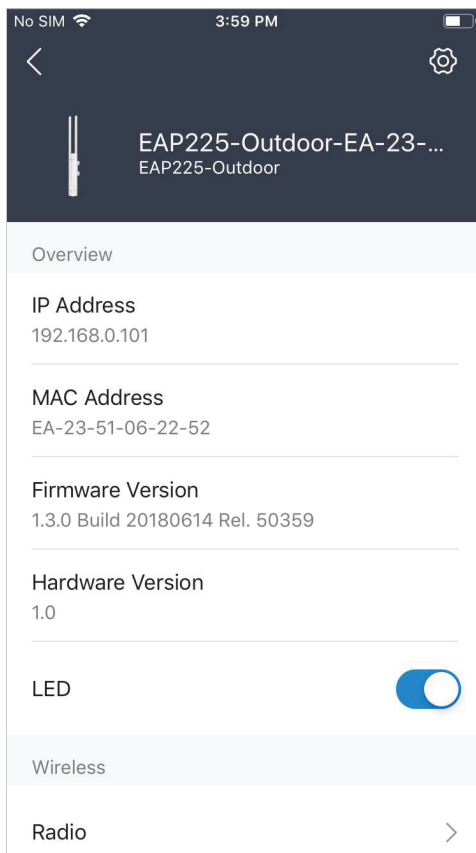
**Tips:**

- Omada app is designed to help you quickly configure some basic settings. For advanced configuration, you can use controller mode. And when your EAP is managed by the controller, you can not use standalone mode.
- In standalone mode, only one user is allowed to log in to the management page of the EAP at the same time. Thus the management web page of the EAP cannot be logged in to when using the Omada app and vice versa. Also only one user can log in to the EAP via Omada app.

3 Manage your Network in Controller Mode

For a large-scale network which has mass EAPs and advanced functions are required, controller mode is recommended. Controller mode allows you to configure and automatically synchronize unified wireless settings to all EAPs in the network.

Omada app offers a convenient way to access the Omada Controller and adopt EAPs. With Local Access and Cloud Access function on the Omada app, you can manage the controller at local and remote sites.

Note:

Omada Controller needs to be kept running when using Omada app to access the controller.

3.1 Locally manage your EAPs using the Omada App

Local Access function on Omada app is designed for accessing the controller which is in the same subnet with your mobile devices. Refer to the topology below, make sure that the following requirements have been met:

- An Ethernet connection from your Omada EAP to the LAN with a DHCP server.
- The version of the Omada Controller is 3.0.2 or above.
- A compatible iOS or Android device with Omada app.

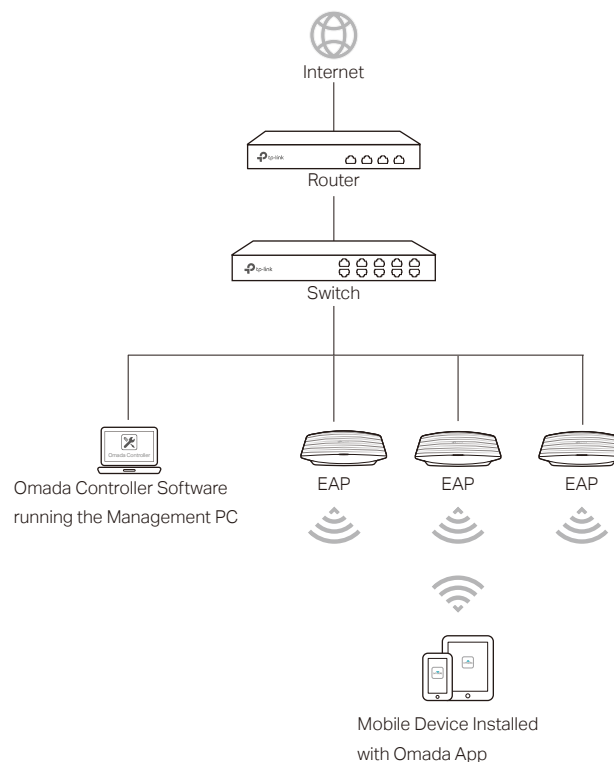

Follow the steps below to manage your network via Omada app in controller mode locally. The following page is exemplified with the iOS version of the app. The Android version is similar.

1. Connect your mobile device to the EAP by using the default SSID (format: **TP-Link 2.4GHz/5GHz_XXXXXX**) printed on the label. Note that the EAP should be in the same subnet with the controller.



2. Launch the Omada app, go to **Local Access**, tap the **+** button on the upper-right corner to add the Omada controller. Normally Omada app will discover the controller which is in the same subnet. If the controller cannot be found, you can add the controller by entering the IP address and port of the controller host in the manual column.

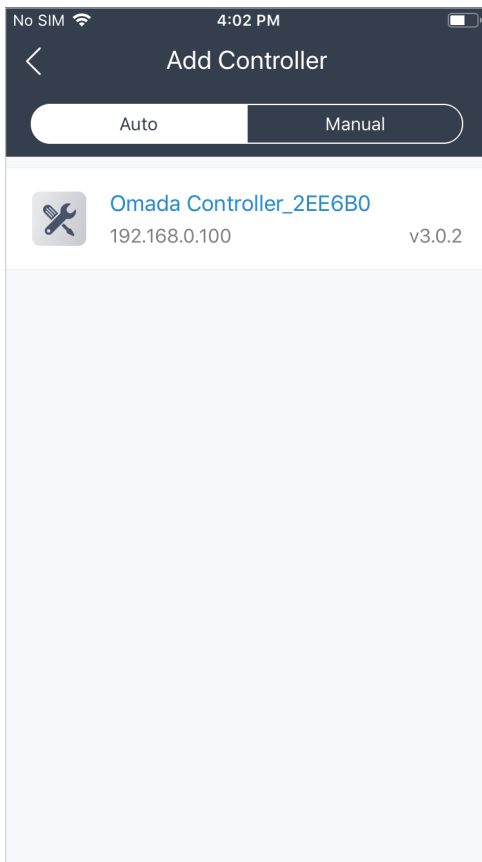

3. Tap the Omada Controller, the controller login page will show. Enter the username and password of the controller, then tap **Log In** to launch the controller.

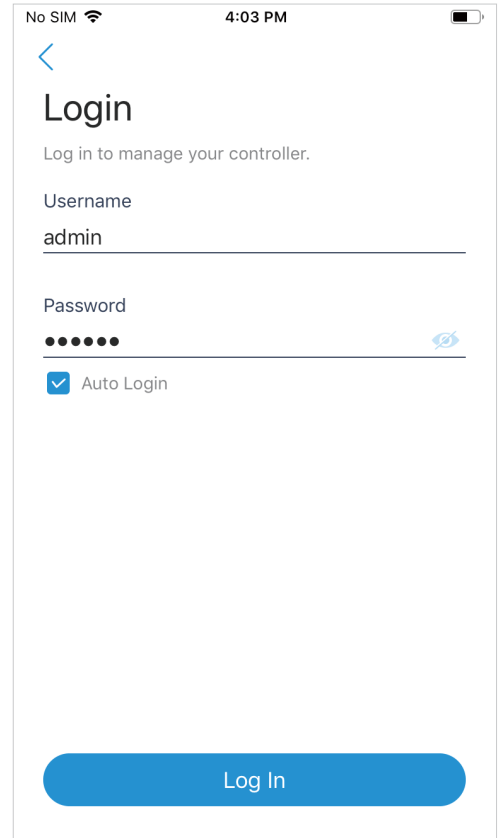

4. On the **APs** screen, tap the EAP that is pending for the adoption. And you can use the functions at the bottom to navigate various screens of the Omada Controller including the wireless statistics, clients information and basic settings.

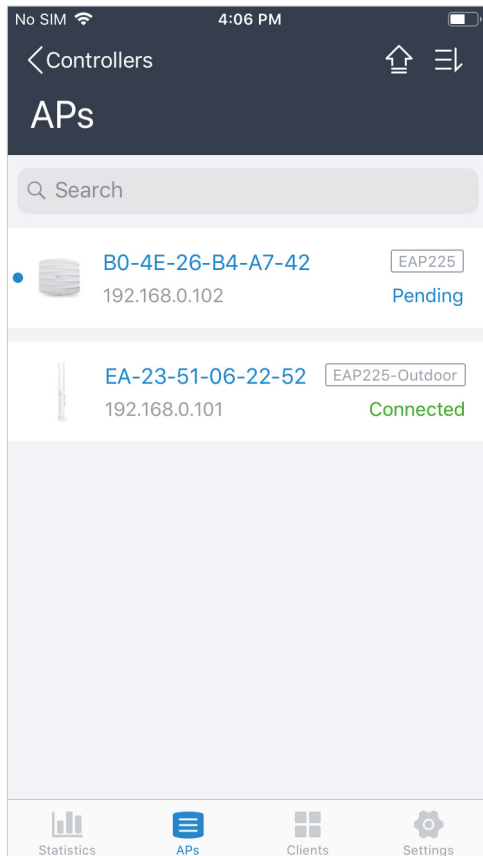

3.2 Remotely manage your EAPs using the Omada App

Cloud Access function on Omada app is designed for accessing the controller via Omada Cloud service. Thus, you can configure your controller and manage EAPs at any time, from anywhere.

Refer to the topology below, make sure that the following requirements have been met:

- Both your Controller Host and mobile device have internet access.
- The version of the Omada Controller is 3.0.2 or above.
- A compatible iOS or Android device with Omada app.
- Cloud Access is enabled on the controller. The controller has been bound with a TP-Link ID. For more details about the Cloud Access on the controller, refer to the [Omada Cloud Service](#).

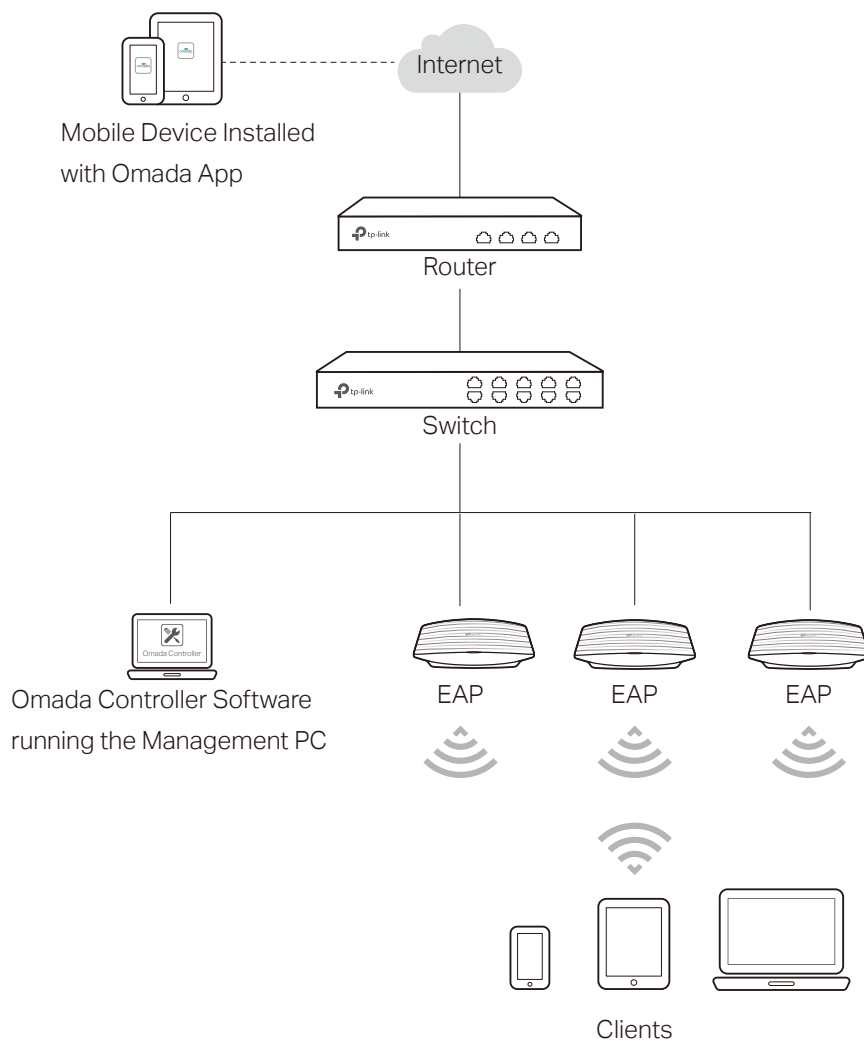

Follow the steps below to manage your network via Omada app in controller mode remotely. The following page is exemplified with the iOS version of the app. The Android version is similar.

1. Launch the Omada app, go to **Cloud Access** and tap **Go to Log In** to log in to Omada Cloud with your TP-Link ID.

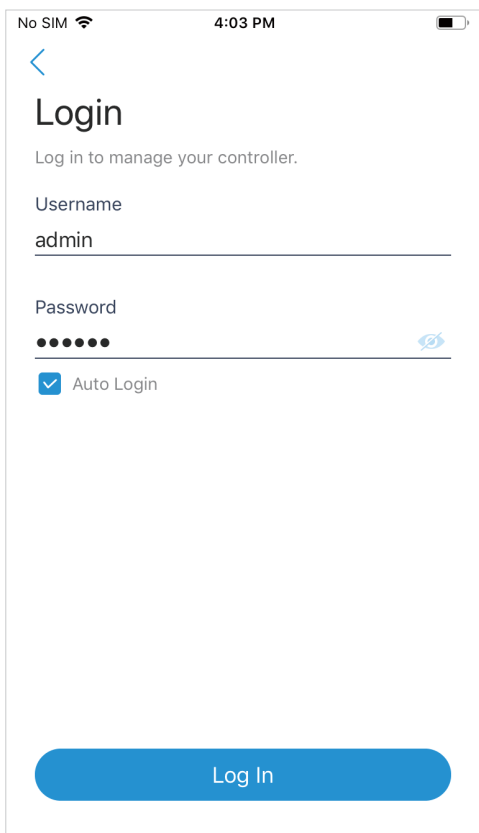

2. All the online controller which are bound with your TP-Link ID will appear on the page. Tap the controller to launch and configure the controller.

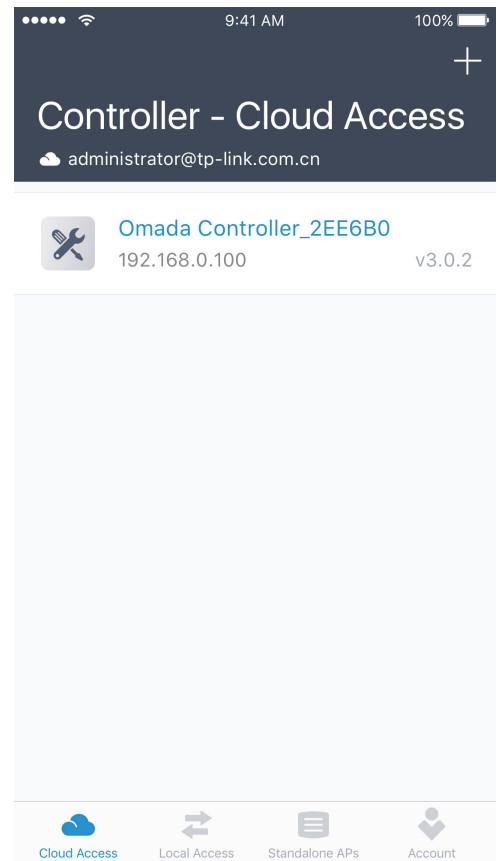

3. On the **APs** screen, tap the EAP that is pending for the adoption. And you can use the functions at the bottom to navigate various screens of the Omada Controller including the wireless statistics, clients information and basic settings.

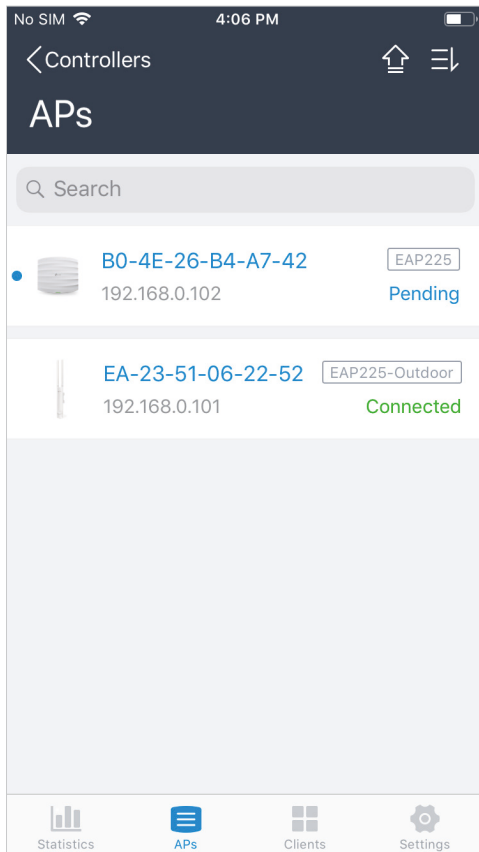

COPYRIGHT & TRADEMARKS

Specifications are subject to change without notice.  tp-link is a registered trademark of TP-Link Technologies Co., Ltd. Other brands and product names are trademarks or registered trademarks of their respective holders.

No part of the specifications may be reproduced in any form or by any means or used to make any derivative such as translation, transformation, or adaptation without permission from TP-Link Technologies Co., Ltd. Copyright © 2019 TP-Link Technologies Co., Ltd.. All rights reserved.