

Version 1.0

Published May 2018

Copyright©2018 ASRock INC. All rights reserved.



Copyright Notice:

No part of this documentation may be reproduced, transcribed, transmitted, or translated in any language, in any form or by any means, except duplication of documentation by the purchaser for backup purpose, without written consent of ASRock Inc.

Products and corporate names appearing in this documentation may or may not be registered trademarks or copyrights of their respective companies, and are used only for identification or explanation and to the owners' benefit, without intent to infringe.

Disclaimer:

Specifications and information contained in this documentation are furnished for informational use only and subject to change without notice, and should not be construed as a commitment by ASRock. ASRock assumes no responsibility for any errors or omissions that may appear in this documentation.

With respect to the contents of this documentation, ASRock does not provide warranty of any kind, either expressed or implied, including but not limited to the implied warranties or conditions of merchantability or fitness for a particular purpose.

In no event shall ASRock, its directors, officers, employees, or agents be liable for any indirect, special, incidental, or consequential damages (including damages for loss of profits, loss of business, loss of data, interruption of business and the like), even if ASRock has been advised of the possibility of such damages arising from any defect or error in the documentation or product.



This device complies with Part 15 of the FCC Rules. Operation is subject to the following two conditions:

- (1) this device may not cause harmful interference, and
- (2) this device must accept any interference received, including interference that may cause undesired operation.

CALIFORNIA, USA ONLY

The Lithium battery adopted on this motherboard contains Perchlorate, a toxic substance controlled in Perchlorate Best Management Practices (BMP) regulations passed by the California Legislature. When you discard the Lithium battery in California, USA, please follow the related regulations in advance.

“Perchlorate Material-special handling may apply, see www.dtsc.ca.gov/hazardouswaste/perchlorate”

ASRock Website: <http://www.asrock.com>

AUSTRALIA ONLY

Our goods come with guarantees that cannot be excluded under the Australian Consumer Law. You are entitled to a replacement or refund for a major failure and compensation for any other reasonably foreseeable loss or damage caused by our goods. You are also entitled to have the goods repaired or replaced if the goods fail to be of acceptable quality and the failure does not amount to a major failure. If you require assistance please call ASRock Tel : +886-2-28965588 ext.123 (Standard International call charges apply)

The terms HDMI™ and HDMI High-Definition Multimedia Interface, and the HDMI logo are trademarks or registered trademarks of HDMI Licensing LLC in the United States and other countries.



Motherboard Layout

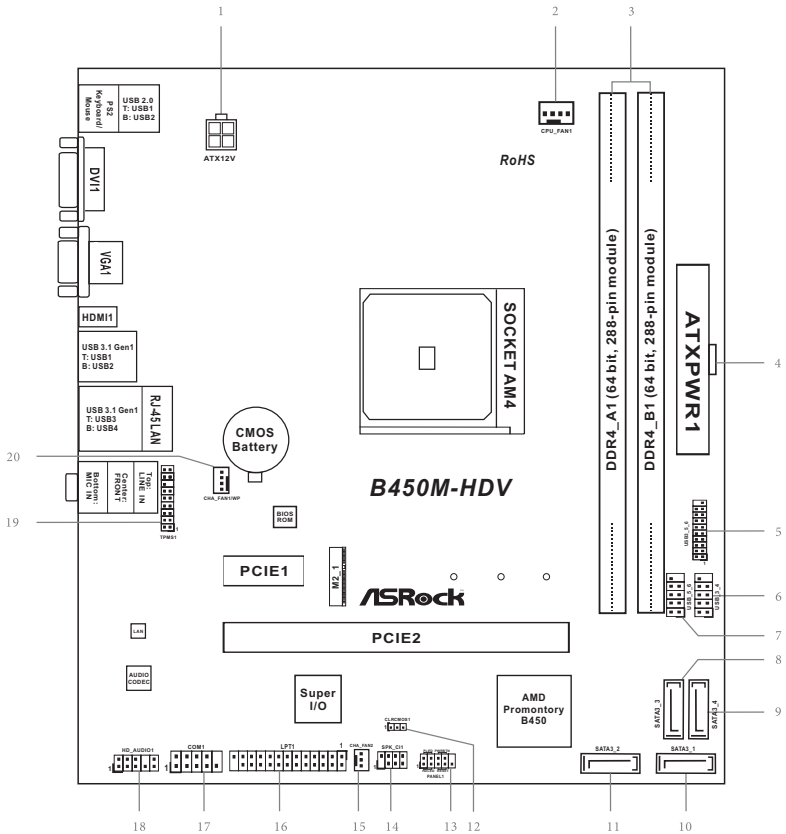

No.	Description
1	ATX 12V Power Connector (ATX12V1)
2	CPU Fan Connector (CPU_FAN1)
3	2 x 288-pin DDR4 DIMM Slots (DDR4_A1, DDR4_B1)
4	ATX Power Connector (ATXPWR1)
5	USB 3.1 Gen1 Header (USB3_5_6)
6	USB 2.0 Header (USB_3_4)
7	USB 2.0 Header (USB_5_6)
8	SATA3 Connector (SATA3_3)
9	SATA3 Connector (SATA3_4)
10	SATA3 Connector (SATA3_1)
11	SATA3 Connector (SATA3_2)
12	Clear CMOS Jumper (CLRCMOS1)
13	System Panel Header (PANEL1)
14	Chassis Intrusion and Speaker Header (SPK_CI1)
15	Chassis Fan Connector (CHA_FAN2)
16	Print Port Header (LPT1)
17	COM Port Header (COM1)
18	Front Panel Audio Header (HD_AUDIO1)
19	TPM Header (TPMS1)
20	Chassis/Water Pump Fan Connector (CHA_FAN1/WP)

I/O Panel

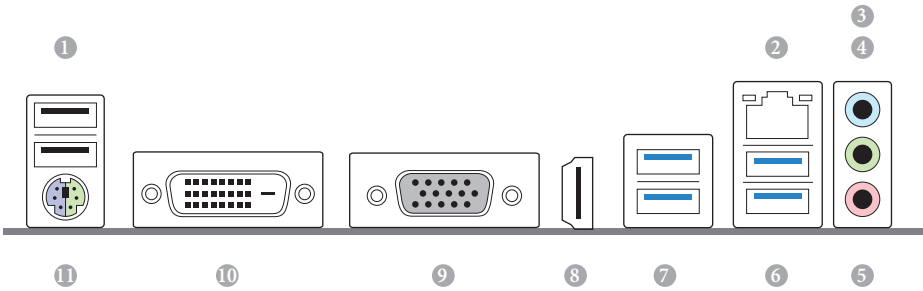

No.	Description	No.	Description
1	USB 2.0 Ports (USB12)	7	USB 3.1 Gen1 Ports (USB3_12)
2	LAN RJ-45 Port*	8	HDMI Port
3	Line In (Light Blue)**	9	D-Sub Port
4	Front Speaker (Lime)**	10	DVI-D Port
5	Microphone (Pink)**	11	PS/2 Mouse/Keyboard Port
6	USB 3.1 Gen1 Ports (USB3_34)		

* There are two LEDs on each LAN port. Please refer to the table below for the LAN port LED indications.

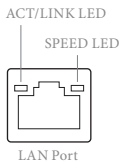

Activity / Link LED		Speed LED	
Status	Description	Status	Description
Off	No Link	Off	10Mbps connection
Blinking	Data Activity	Orange	100Mbps connection
On	Link	Green	1Gbps connection

** To configure 7.1 CH HD Audio, it is required to use an HD front panel audio module and enable the multi-channel audio feature through the audio driver.

Please set Speaker Configuration to "7.1 Speaker" in the Realtek HD Audio Manager.



Function of the Audio Ports in 7.1-channel Configuration:

Port	Function
Light Blue (Rear panel)	Rear Speaker Out
Lime (Rear panel)	Front Speaker Out
Pink (Rear panel)	Central /Subwoofer Speaker Out
Lime (Front panel)	Side Speaker Out

Chapter 1 Introduction

Thank you for purchasing ASRock B450M-HDV motherboard, a reliable motherboard produced under ASRock's consistently stringent quality control. It delivers excellent performance with robust design conforming to ASRock's commitment to quality and endurance.



Because the motherboard specifications and the BIOS software might be updated, the content of this manual will be subject to change without notice. In case any modifications of this manual occur, the updated version will be available on ASRock's website without further notice. If you require technical support related to this motherboard, please visit our website for specific information about the model you are using. You may find the latest VGA cards and CPU support list on ASRock's website as well. ASRock website <http://www.asrock.com>.

1.1 Package Contents

- ASRock B450M-HDV Motherboard (Micro ATX Form Factor)
- ASRock B450M-HDV Quick Installation Guide
- ASRock B450M-HDV Support CD
- 2 x Serial ATA (SATA) Data Cables (Optional)
- 1 x Screw for M.2 Socket (Optional)
- 1 x I/O Panel Shield

1.2 Specifications

- Platform**
- Micro ATX Form Factor
 - Solid Capacitor design

- CPU**
- AMD AM4 Socket
 - Digi Power design
 - Supports CPU up to 105W

- Chipset**
- AMD Promontory B450

- Memory**
- Dual Channel DDR4 Memory Technology
 - 2 x DDR4 DIMM Slots
 - AMD Ryzen series CPUs (Pinnacle Ridge) support DDR4 3200+(OC)/2933/2667/2400/2133 ECC & non-ECC, un-buffered memory*
 - AMD Ryzen series CPUs (Summit Ridge) support DDR4 3200+(OC)/2933(OC)/2667/2400/2133 ECC & non-ECC, un-buffered memory*
 - AMD Ryzen series CPUs (Raven Ridge) support DDR4 3200+(OC)/2933(OC)/2667/2400/2133 non-ECC, un-buffered memory*

* For Ryzen Series CPUs (Raven Ridge), ECC is only supported with PRO CPUs.

* Please refer to Memory Support List on ASRock's website for more information. (<http://www.asrock.com/>)

* Please refer to page 11 for DDR4 UDIMM maximum frequency support.

- Max. capacity of system memory: 32GB
- 15µ Gold Contact in DIMM Slots

- Expansion Slot**
- AMD Ryzen series CPUs (Summit Ridge and Pinnacle Ridge)**
- 1 x PCI Express 3.0 x16 Slot (PCIe2: x16 mode)*

AMD Ryzen series CPUs (Raven Ridge)

- 1 x PCI Express 3.0 x16 Slot (PCIe2: x8 mode)*

* Supports NVMe SSD as boot disks

- 1 x PCI Express 2.0 x1 Slot

Graphics

- Integrated AMD Radeon™ Vega Series Graphics in Ryzen Series APU*

* Actual support may vary by CPU

- DirectX 12, Pixel Shader 5.0
- Max. shared memory 2GB
- Three graphics output options: D-Sub, DVI-D and HDMI
- Supports Triple Monitor
- Supports HDMI with max. resolution up to 4K x 2K (4096x2160) @ 24Hz / (3840x2160) @ 30Hz
- Supports DVI-D with max. resolution up to 1920x1200 @ 60Hz
- Supports D-Sub with max. resolution up to 2048x1536 @ 60Hz
- Supports Auto Lip Sync, Deep Color (12bpc), xvYCC and HBR (High Bit Rate Audio) with HDMI Port (Compliant HDMI monitor is required)
- Supports HDCP with DVI-D and HDMI Ports
- Supports 4K Ultra HD (UHD) playback with HDMI Port

Audio

- 7.1 CH HD Audio (Realtek ALC887 Audio Codec)

* To configure 7.1 CH HD Audio, it is required to use an HD front panel audio module and enable the multi-channel audio feature through the audio driver.

- Supports Surge Protection
- ELNA Audio Caps

LAN

- PCIe x1 Gigabit LAN 10/100/1000 Mb/s
- Realtek RTL8111H
- Supports Wake-On-LAN
- Supports Lightning/ESD Protection
- Supports Energy Efficient Ethernet 802.3az
- Supports PXE

Rear Panel I/O

- 1 x PS/2 Mouse/Keyboard Port
- 1 x D-Sub Port
- 1 x DVI-D Port
- 1 x HDMI Port
- 2 x USB 2.0 Ports (Supports ESD Protection)
- 4 x USB 3.1 Gen1 Ports (Supports ESD Protection)
- 1 x RJ-45 LAN Port with LED (ACT/LINK LED and SPEED LED)
- HD Audio Jacks: Line in / Front Speaker / Microphone

Storage

- 4 x SATA3 6.0 Gb/s Connectors, support RAID (RAID 0, RAID 1 and RAID 10), NCQ, AHCI and Hot Plug
- 1 x Ultra M.2 Socket, supports M Key type 2242/2260/2280 M.2 SATA3 6.0 Gb/s module and M.2 PCI Express module up to Gen3 x4 (32 Gb/s) (with Summit Ridge, Raven Ridge and Pinnacle Ridge)*

* Supports NVMe SSD as boot disks

* Supports ASRock U.2 Kit

Connector

- 1 x Print Port Header
- 1 x COM Port Header
- 1 x TPM Header
- 1 x Chassis Intrusion and Speaker Header
- 1 x CPU Fan Connector (4-pin)
* The CPU Fan Connector supports the CPU fan of maximum 1A (12W) fan power.
- 1 x Chassis Fan Connector (3-pin)
* The Chassis Fan Connector supports the chassis fan of maximum 1A (12W) fan power.
- 1 x Chassis/Water Pump Fan Connector (4-pin) (Smart Fan Speed Control)
* The Chassis/Water Pump Fan Connector supports the water cooler fan of maximum 2A (24W) fan power.

* CHA_FAN1/WP can auto detect if 3-pin or 4-pin fan is in use.

- 1 x 24 pin ATX Power Connector
- 1 x 4 pin 12V Power Connector
- 1 x Front Panel Audio Connector
- 2 x USB 2.0 Headers (Support 4 USB 2.0 ports) (Supports ESD Protection)
- 1 x USB 3.1 Gen1 Header (Supports 2 USB 3.1 Gen1 ports) (Supports ESD Protection)

BIOS Feature

- AMI UEFI Legal BIOS with GUI support
- Supports “Plug and Play”
- ACPI 5.1 compliance wake up events
- Supports jumperfree
- SMBIOS 2.3 support
- DRAM Voltage multi-adjustment

Hardware Monitor

- Temperature Sensing: CPU, Chassis, Chassis/Water Pump Fans
- Fan Tachometer: CPU, Chassis, Chassis/Water Pump Fans
- Quiet Fan (Auto adjust chassis fan speed by CPU temperature): CPU, Chassis, Chassis/Water Pump Fans
- Fan Multi-Speed Control: CPU, Chassis, Chassis/Water Pump Fans
- CASE OPEN detection
- Voltage monitoring: +12V, +5V, +3.3V, Vcore

OS

- Microsoft® Windows® 10 64-bit

Certifica- tions

- FCC, CE
- ErP/EuP ready (ErP/EuP ready power supply is required)

* For detailed product information, please visit our website: <http://www.asrock.com>



Please realize that there is a certain risk involved with overclocking, including adjusting the setting in the BIOS, applying Untied Overclocking Technology, or using third-party overclocking tools. Overclocking may affect your system's stability, or even cause damage to the components and devices of your system. It should be done at your own risk and expense. We are not responsible for possible damage caused by overclocking.

Chapter 2 Installation

This is a Micro ATX form factor motherboard. Before you install the motherboard, study the configuration of your chassis to ensure that the motherboard fits into it.

Pre-installation Precautions

Take note of the following precautions before you install motherboard components or change any motherboard settings.

- Make sure to unplug the power cord before installing or removing the motherboard. Failure to do so may cause physical injuries to you and damages to motherboard components.
- In order to avoid damage from static electricity to the motherboard's components, NEVER place your motherboard directly on a carpet. Also remember to use a grounded wrist strap or touch a safety grounded object before you handle the components.
- Hold components by the edges and do not touch the ICs.
- Whenever you uninstall any components, place them on a grounded anti-static pad or in the bag that comes with the components.
- When placing screws to secure the motherboard to the chassis, please do not over-tighten the screws! Doing so may damage the motherboard.

2.1 Installing the CPU

Please refer to our User Manual in the support CD for the CPU installation guide.

2.2 Installing Memory Modules (DIMM)

This motherboard provides two 288-pin DDR4 (Double Data Rate 4) DIMM slots, and supports Dual Channel Memory Technology.



1. For dual channel configuration, you always need to install identical (the same brand, speed, size and chip-type) DDR4 DIMM pairs.
2. It is unable to activate Dual Channel Memory Technology with only one memory module installed.
3. It is not allowed to install a DDR, DDR2 or DDR3 memory module into a DDR4 slot; otherwise, this motherboard and DIMM may be damaged.

DDR4 UDIMM Maximum Frequency Support

Ryzen Series CPUs (Pinnacle Ridge):

UDIMM Memory Slot		Frequency (Mhz)
A1	B1	
-	SR	2667
SR	-	2667
-	DR	2400
DR	-	2400
SR	SR	2667
DR	DR	2400

Ryzen Series CPUs (Summit Ridge):

UDIMM Memory Slot		Frequency (Mhz)
A1	B1	
-	SR	2667
SR	-	2667
-	DR	2667
DR	-	2667
SR	SR	2667
DR	DR	2667

Ryzen Series CPUs (Raven Ridge):

UDIMM Memory Slot		Frequency (Mhz)
A1	B1	
-	SR	2933
SR	-	2933
-	DR	2667
DR	-	2667
SR	SR	2667
DR	DR	2400

SR: Single rank DIMM, 1Rx4 or 1Rx8 on DIMM module label

DR: Dual rank DIMM, 2Rx4 or 2Rx8 on DIMM module label



The DIMM only fits in one correct orientation. It will cause permanent damage to the motherboard and the DIMM if you force the DIMM into the slot at incorrect orientation.

1

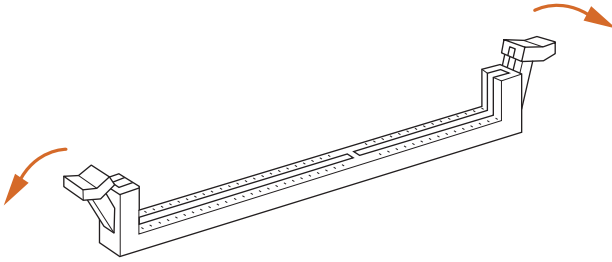

2

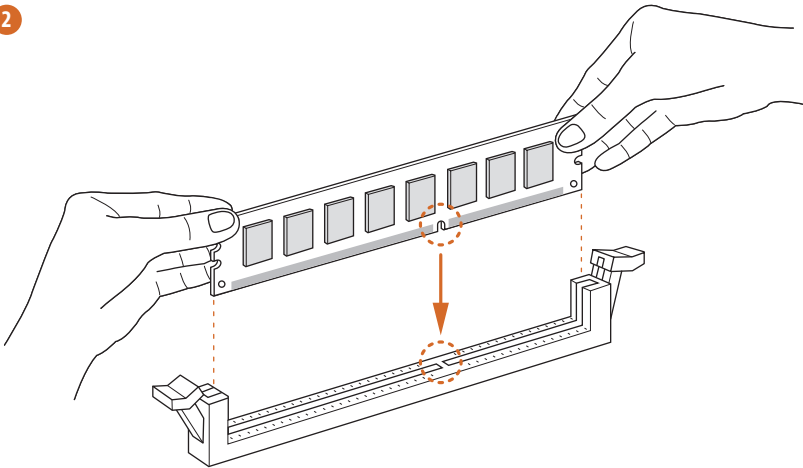

3

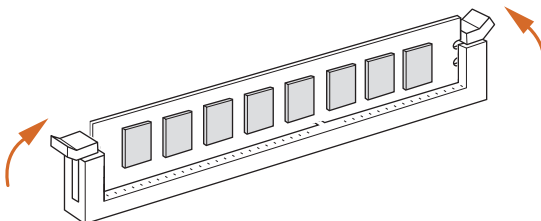

2.3 Expansion Slots (PCI Express Slots)

There are 2 PCI Express slots on the motherboard.



Before installing an expansion card, please make sure that the power supply is switched off or the power cord is unplugged. Please read the documentation of the expansion card and make necessary hardware settings for the card before you start the installation.

PCIe slots:

PCIE1 (PCIe 2.0 x1 slot) is used for PCI Express x1 lane width cards.

PCIE2 (PCIe 3.0 x16 slot) is used for PCI Express x16 lane width graphics cards.

PCIe Slot Configurations

	PCIE1	PCIE2
Ryzen Series CPUs (Pinnacle Ridge)	x1	x16
Ryzen Series CPUs (Summit Ridge)	x1	x16
Ryzen Series CPUs (Raven Ridge)	x1	x8

2.4 Jumpers Setup

The illustration shows how jumpers are setup. When the jumper cap is placed on the pins, the jumper is “Short”. If no jumper cap is placed on the pins, the jumper is “Open”. The illustration shows a 3-pin jumper whose pin1 and pin2 are “Short” when a jumper cap is placed on these 2 pins.

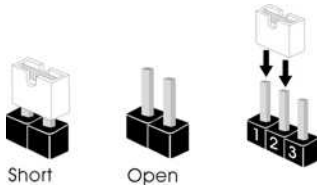

Clear CMOS Jumper
(CLR CMOS1)
(see p.1, No. 12)

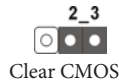

CLR CMOS1 allows you to clear the data in CMOS. To clear and reset the system parameters to default setup, please turn off the computer and unplug the power cord from the power supply. After waiting for 15 seconds, use a jumper cap to short pin2 and pin3 on CLR CMOS1 for 5 seconds. However, please do not clear the CMOS right after you update the BIOS. If you need to clear the CMOS when you just finish updating the BIOS, you must boot up the system first, and then shut it down before you do the clear-CMOS action. Please be noted that the password, date, time, and user default profile will be cleared only if the CMOS battery is removed.



If you clear the CMOS, the case open may be detected. Please adjust the BIOS option “Clear Status” to clear the record of previous chassis intrusion status.

2.5 Onboard Headers and Connectors



Onboard headers and connectors are NOT jumpers. Do NOT place jumper caps over these headers and connectors. Placing jumper caps over the headers and connectors will cause permanent damage to the motherboard.

System Panel Header
(9-pin PANEL1)
(see p.1, No. 13)

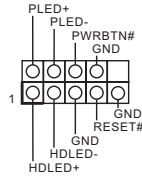

Connect the power switch, reset switch and system status indicator on the chassis to this header according to the pin assignments below. Note the positive and negative pins before connecting the cables.



PWRBTN (Power Switch):

Connect to the power switch on the chassis front panel. You may configure the way to turn off your system using the power switch.

RESET (Reset Switch):

Connect to the reset switch on the chassis front panel. Press the reset switch to restart the computer if the computer freezes and fails to perform a normal restart.

PLED (System Power LED):

Connect to the power status indicator on the chassis front panel. The LED is on when the system is operating. The LED keeps blinking when the system is in S3 sleep state. The LED is off when the system is in S4 sleep state or powered off (S5).

HDLED (Hard Drive Activity LED):

Connect to the hard drive activity LED on the chassis front panel. The LED is on when the hard drive is reading or writing data.

The front panel design may differ by chassis. A front panel module mainly consists of power switch, reset switch, power LED, hard drive activity LED, speaker and etc. When connecting your chassis front panel module to this header, make sure the wire assignments and the pin assignments are matched correctly.

Chassis Intrusion and Speaker Header
(7-pin SPK_C11)
(see p.1, No. 14)

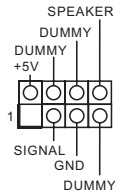

Please connect the chassis intrusion and the chassis speaker to this header.

Serial ATA3 Connectors
(SATA3_1:
see p.1, No. 10)
(SATA3_2:
see p.1, No. 11)
(SATA3_3:
see p.1, No. 8)
(SATA3_4:
see p.1, No. 9)

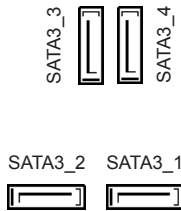

These four SATA3 connectors support SATA data cables for internal storage devices with up to 6.0 Gb/s data transfer rate.

USB 2.0 Headers
(9-pin USB_3_4)
(see p.1, No. 6)
(9-pin USB_5_6)
(see p.1, No. 7)

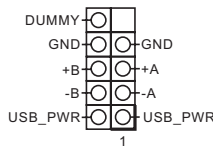

There are two headers on this motherboard. Each USB 2.0 header can support two ports.

USB 3.1 Gen1 Header
(19-pin USB3_5_6)
(see p.1, No. 5)

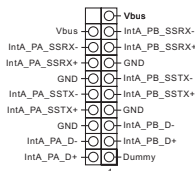

There is one header on this motherboard. This USB 3.1 Gen1 header can support two ports.

Front Panel Audio Header
(9-pin HD_AUDIO1)
(see p.1, No. 18)

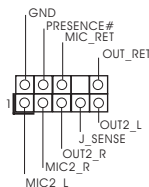

This header is for connecting audio devices to the front audio panel.



1. High Definition Audio supports Jack Sensing, but the panel wire on the chassis must support HDA to function correctly. Please follow the instructions in our manual and chassis manual to install your system.
2. If you use an AC'97 audio panel, please install it to the front panel audio header by the steps below:
 - A. Connect Mic_IN (MIC) to MIC2_L.
 - B. Connect Audio_R (RIN) to OUT2_R and Audio_L (LIN) to OUT2_L.
 - C. Connect Ground (GND) to Ground (GND).
 - D. MIC_RET and OUT_RET are for the HD audio panel only. You don't need to connect them for the AC'97 audio panel.
 - E. To activate the front mic, go to the "FrontMic" Tab in the Realtek Control panel and adjust "Recording Volume".

Chassis Fan Connector
(3-pin CHA_FAN2)
(see p.1, No. 15)

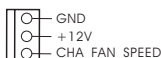

Please connect fan cables to the fan connectors and match the black wire to the ground pin.

Chassis/Water Pump Fan Connector
(4-pin CHA_FAN1/WP)
(see p.1, No. 20)

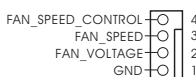

This motherboard provides a 4-Pin water cooling chassis fan connector. If you plan to connect a 3-Pin chassis water cooler fan, please connect it to Pin 1-3.

CPU Fan Connector
(4-pin CPU_FAN1)
(see p.1, No. 2)

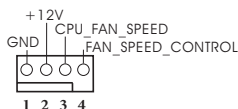

This motherboard provides a 4-Pin CPU fan (Quiet Fan) connector. If you plan to connect a 3-Pin CPU fan, please connect it to Pin 1-3.

ATX Power Connector
(24-pin ATXPWR1)
(see p.1, No. 4)

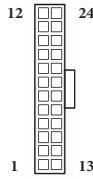

This motherboard provides a 24-pin ATX power connector. To use a 20-pin ATX power supply, please plug it along Pin 1 and Pin 13.

ATX 12V Power Connector
(4-pin ATX12V1)
(see p.1, No. 1)



This motherboard provides a 4-pin ATX 12V power connector.

Serial Port Header
(9-pin COM1)
(see p.1, No. 17)

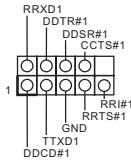

This COM1 header supports a serial port module.

TPM Header
(17-pin TPMS1)
(see p.1, No. 19)

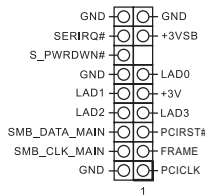

This connector supports Trusted Platform Module (TPM) system, which can securely store keys, digital certificates, passwords, and data. A TPM system also helps enhance network security, protects digital identities, and ensures platform integrity.

Print Port Header
(25-pin LPT1)
(see p.1, No. 16)

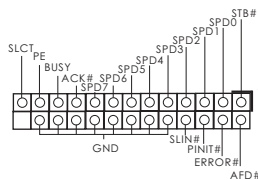

This is an interface for print port cable that allows convenient connection of printer devices.

2.6 M.2_SSD (NGFF) Module Installation Guide

The M.2, also known as the Next Generation Form Factor (NGFF), is a small size and versatile card edge connector that aims to replace mPCIe and mSATA. The Ultra M.2 Socket supports SATA3 6.0 Gb/s module and M.2 PCI Express module up to Gen3 x4 (32 Gb/s) (with Summit Ridge, Raven Ridge and Pinnacle Ridge).

Installing the M.2_SSD (NGFF) Module

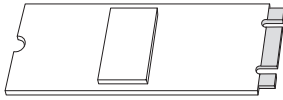

Step 1

Prepare a M.2_SSD (NGFF) module and the screw.

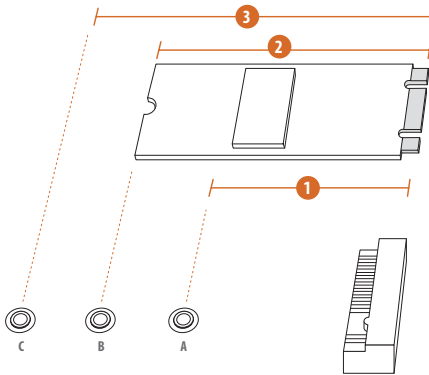

Step 2

Depending on the PCB type and length of your M.2_SSD (NGFF) module, find the corresponding nut location to be used.

No.	1	2	3
Nut Location	A	B	C
PCB Length	4.2cm	6cm	8cm
Module Type	Type 2242	Type2260	Type 2280

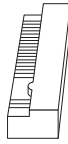
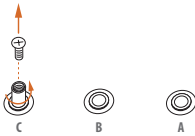
**Step 3**

Move the standoff based on the module type and length. The standoff is placed at the nut location C by default. Skip Step 3 and 4 and go straight to Step 5 if you are going to use the default nut. Otherwise, release the standoff by hand.

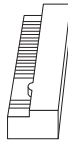
**Step 4**

Peel off the yellow protective film on the nut to be used. Hand tighten the standoff into the desired nut location on the motherboard.

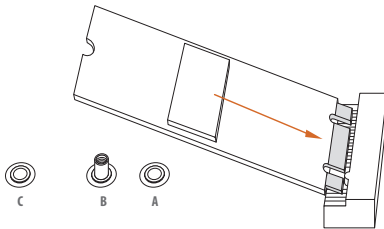
**Step 5**

Gently insert the M.2 (NGFF) SSD module into the M.2 slot. Please be aware that the M.2 (NGFF) SSD module only fits in one orientation.

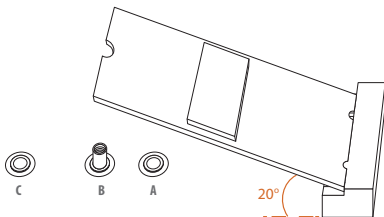

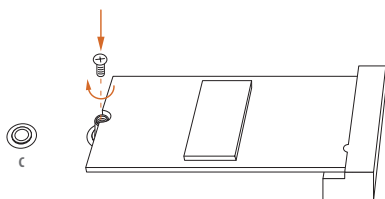

Step 6

Tighten the screw with a screwdriver to secure the module into place. Please do not overtighten the screw as this might damage the module.

M.2_SSD (NGFF) Module Support List

Vendor	Interface	P/N
SanDisk	PCIe	SanDisk-SD6PP4M-128G(Gen2 x2)
Intel	PCIe	INTEL 6000P-SSDPEKKF256G7 (nvme)
Intel	PCIe	INTEL 6000P-SSDPEKKF512G7 (nvme)
Kingston	PCIe	Kingston SHPM2280P2 / 240G (Gen2 x4)
Samsung	PCIe	Samsung XP941-MZHPU512HCGL(Gen2x4)
ADATA	SATA	ADATA - AXNS381E-128GM-B
Crucial	SATA	Crucial-CT240M500SSD4-240GB
ezlink	SATA	ezlink P51B-80-120GB
Intel	SATA	INTEL 540S-SSDSCKKW240H6-240GB
Kingston	SATA	Kingston SM2280S3G2/120G - Win8.1
Kingston	SATA	Kingston-RBU-SNS8400S3 / 180GD
LITEON	SATA	LITEON LJH-256V2G-256GB (2260)
PLEXTOR	SATA	PLEXTOR PX-128M6G-2260-128GB
PLEXTOR	SATA	PLEXTOR PX-128M7VG-128GB
SanDisk	SATA	SanDisk X400-SD8SN8U-128G
SanDisk	SATA	Sandisk Z400s-SD8SNAT-128G-1122
SanDisk	SATA	SanDisk-SD6SNIM-128G
Transcend	SATA	Transcend TS256GMTS800-256GB
V-Color	SATA	V-Color 120G
V-Color	SATA	V-Color 240G
WD	SATA	WD GREEN WDS240G1G0B-00RC30

For the latest updates of M.2_SSD (NFGG) module support list, please visit our website for details: <http://www.asrock.com>

Technische Daten

- Plattform**
- Micro-ATX-Formfaktor
 - Feststoffkondensator-Design

- Prozessor**
- AMD-AM4-Sockel
 - Digi Power design
 - Unterstützt CPU bis 105 W

- Chipsatz**
- AMD Promontory B450

- Speicher**
- Dualkanal-DDR4-Speichertechnologie
 - 2 x DDR4-DIMM-Steckplätze
 - Prozessoren der AMD-Ryzen-Serie (Pinnacle Ridge) unterstützen DDR4 3200+(OC)/2933/2667/2400/2133 ECC und non-ECC, ungepufferter Speicher*
 - Prozessoren der AMD-Ryzen-Serie (Summit Ridge) unterstützen DDR4 3200+(OC)/2933 (OC)/2667/2400/2133 ECC und non-ECC, ungepufferter Speicher*
 - Prozessoren der AMD-Ryzen-Serie (Raven Ridge) unterstützen DDR4 3200+(OC)/2933 (OC)/2667/2400/2133 non-ECC, ungepufferter Speicher*
- * Für Prozessoren der Ryzen-Serie (Raven Ridge), ECC wird nur mit PRO-Prozessoren unterstützt.
- * Weitere Informationen finden Sie in der Speicherkompatibilitätsliste auf der ASRock-Webseite. (<http://www.asrock.com/>)
- * Bitte beachten Sie Seite 11 für die maximal unterstützte Frequenz von DDR4-UDIMM.
- Systemspeicher, max. Kapazität: 32 GB
 - 15- μ -Goldkontakt in DIMM-Steckplätze

- Erweiterungssteckplatz**
- CPUs der AMD-Ryzen-Serie (Summit Ridge und Pinnacle Ridge)**
- 1 x PCI-Express 3.0-x16-Steckplatz (PCIe2:x16-Modus)*
- CPUs der AMD-Ryzen-Serie (Raven Ridge)**
- 1 x PCI-Express 3.0-x16-Steckplatz (PCIe2:x8-Modus)*

- * Unterstützt NVMe-SSD als Bootplatte
- 1 x PCI-Express 2.0-x1-Steckplatz

Grafikkarte

- Integrierte Grafikkarte der AMD-Radeon™-Vega-Serie in APU der Ryzen-Serie*
- * Tatsächliche Unterstützung kann je nach Prozessor variieren
- DirectX 12, Pixel Shader 5.0
- Max. geteilter Speicher 2GB
- Drei Grafikkarten-Ausgangsoptionen: D-Sub, DVI-D und HDMI
- Unterstützt drei Monitore
- Unterstützt HDMI mit maximaler Auflösung von 4K x 2K (4096 x 2160) bei 24 Hz / (3840 x 2160) bei 30 Hz
- Unterstützt DVI-D mit maximaler Auflösung von 1920 x 1200 bei 60 Hz
- Unterstützt D-Sub mit maximaler Auflösung von 2048 x 1536 bei 60 Hz
- Unterstützt Auto-Lippensynchronizität, hohe Farbtiefe (12 bpc), xvYCC und HBR (Audio mit hoher Bitrate) mit HDMI-Port (konformer HDMI-Monitor erforderlich)
- Unterstützt HDCP mit DVI-D- und HDMI-Ports
- Unterstützt 4K-Ultra-HD- (UHD) Wiedergabe mit HDMI-Port

Audio

- 7.1-Kanal-HD-Audio (Realtek ALC887-Audiocodec)
- * Zur Konfiguration von 7.1-Kanal-HD-Audio müssen Sie ein HD-Frontblenden-Audiomodul nutzen und den Mehrkanalton über den Audiotreiber aktivieren.
- Unterstützt Überspannungsschutz
- ELNA-Audiokondensatoren

LAN

- PCIE-x1-Gigabit-LAN 10/100/1000 Mb/s
- Realtek RTL8111H
- Unterstützt Wake-On-LAN
- Unterstützt Schutz gegen Blitzschlag/elektrostatische Entladung
- Unterstützt energieeffizientes Ethernet 802.3az
- Unterstützt PXE

Rückblende, E/A

- 1 x PS/2-Maus-/Tastaturanschluss
- 1 x D-Sub-Port
- 1 x DVI-D-Port
- 1 x HDMI-Port
- 2 x USB-2.0-Ports (unterstützt Schutz gegen elektrostatische Entladung)
- 4 x USB-3.1-Gen1-Ports (unterstützt Schutz gegen elektrostatische Entladung)
- 1 x RJ-45-LAN-Port mit LED (Aktivität/Verbindung-LED und Geschwindigkeit-LED)
- HD-Audioanschlüsse: Line-in / Vorderer Lautsprecher / Mikrofon

Speicher

- 4 x SATA-III-6,0-Gb/s-Anschlüsse, unterstützt RAID (RAID 0, RAID 1 und RAID 10), NCQ, AHCI und Hot-Plugging
- 1 x Ultra-M.2-Sockel, unterstützt M-Key-Typ-2242/2260/2280-M.2-SATA-III-6,0-Gb/s-Modul und M.2-PCI-Express-Modul bis Gen3 x 4 (32 Gb/s) (mit Summit Ridge, Raven Ridge und Pinnacle Ridge)*

* Unterstützt NVMe-SSD als Bootplatte

* Unterstützt ASRock U.2-Kit

Anschluss

- 1 x Druckerport-Anschlussleiste
 - 1 x COM-Anschluss-Stiftleiste
 - 1 x TPM-Stiftleiste
 - 1 x Gehäuseeingriff- und Lautsprecher-Stiftleiste
 - 1 x CPU-Lüfteranschluss (4-polig)
- * Der CPU-Lüfteranschluss unterstützt einen CPU-Lüfter mit einer maximalen Lüfterleistung von 1 A (12 W).
- 1 x Gehäuselüfteranschluss (3-polig)
- * Der Gehäuselüfteranschluss unterstützt einen Gehäuselüfter mit einer maximalen Lüfterleistung von 1 A (12 W).
- 1 x Anschluss Gehäuse/Wasserpumpenlüfter (4-polig) (intelligente Lüftergeschwindigkeitssteuerung)
- * Der Gehäuse-/Wasserpumpenlüfteranschluss unterstützt einen Wasserkühlerlüfter mit einer maximalen Lüfterleistung von 2A (24 W).
- * CHA_FAN1/WP können automatisch erkennen, ob ein 3- oder 4-poliger Lüfter verwendet wird.
- 1 x 24-poliger ATX-Netzanschluss
 - 1 x 4-poliger 12-V-Netzanschluss
 - 1 x Audioanschluss an Frontblende
 - 2 x USB 2.0-Stiftleisten (unterstützt 4 USB 2.0-Ports) (unterstützt Schutz gegen elektrostatische Entladung)
 - 1 x USB 3.1 Gen1-Stiftleiste (unterstützt zwei USB 3.1 Gen1-Ports) (unterstützt Schutz gegen elektrostatische Entladung)

Betriebssystem

- Microsoft® Windows® 10, 64 Bit

Spécifications

- Plateforme**
- Facteur de forme Micro ATX
 - Conception à condensateurs solides

- Processeur**
- AM4 à socket AMD
 - Digi Power design
 - Prend en charge les unités centrales jusqu'à 105W

- Chipset**
- AMD Promontory B450

- Mémoire**
- Technologie mémoire double canal DDR4
 - 2 x fentes DIMM DDR4
 - Les processeurs AMD série Ryzen (Pinnacle Ridge) prennent en charge les mémoires sans tampon* ECC et non ECC DDR4 3200+(OC)/2933/2667/2400/2133
 - Les processeurs AMD série Ryzen (Summit Ridge) prennent en charge les mémoires sans tampon* ECC et non ECC DDR4 3200+(OC)/2933 (OC)/2667/2400/2133
 - Les processeurs AMD série Ryzen (Raven Ridge) prennent en charge les mémoires sans tampon* non ECC DDR4 3200+(OC)/2933 (OC)/2667/2400/2133
- * Sur les processeurs série Ryzen (Raven Ridge), ECC est pris en charge uniquement avec les processeurs PRO.
- * Veuillez consulter la liste de prise en charge des mémoires sur le site Web d'ASRock pour de plus amples informations. (<http://www.asrock.com/>)
- * Veuillez consulter la page 11 pour connaître la prise en charge de la fréquence maximale de l'UDIMM DDR4.
- Capacité max. de la mémoire système : 32Go
 - Contacts dorés 15µ sur fentes DIMM

Fente d'expansion

Processeurs AMD série Ryzen (Summit Ridge et Pinnacle Ridge)

- 1 x fente PCI Express 3.0 x 16 (PCIe2 :mode x16)*

Processeurs AMD série Ryzen (Raven Ridge)

- 1 x fente PCI Express 3.0 x 16 (PCIe2 :mode x8)*

* Prend en charge les SSD NVMe comme disques de démarrage

- 1 x fente PCI Express 2.0 x1

Graphiques

- Carte graphique AMD Radeon™ série Vega intégrée dans APU série Ryzen*
- La prise en charge réelle peut varier selon le processeur
- DirectX 12, Pixel Shader 5.0
- Mémoire partagée max. 2 Go
- Trois options de sortie graphique : D-Sub, DVI-D et HDMI
- Prend en charge la configuration à triple moniteurs
- Prend en charge la technologie HDMI avec résolution maximale de 4K × 2K (4096x2160) @ 24Hz / (3840x2160) @ 30Hz
- Prend en charge le mode DVI-D avec une résolution maximale de 1920x1200 @ 60Hz
- Prend en charge le mode D-Sub avec une résolution maximale de 2048x1536 @ 60 Hz
- Prend en charge les technologies Auto Lip Sync, Deep Color (12bpc), xvYCC et HBR (High Bit Rate Audio) avec port HDMI (un écran compatible HDMI est requis)
- Prend en charge HDCP via ports DVI-D et HDMI
- Prend en charge la lecture 4K Ultra HD (UHD) avec le port HDMI

Audio

- Audio 7.1 CH HD (Codec audio Realtek ALC887)
- *Pour configurer l'audio 7.1 CH HD, il est nécessaire d'utiliser un module audio HD pour panneau frontal et d'activer la fonction audio multicanal via le pilote audio.
- Prend en charge la protection contre les surtensions
- Capuchons ELNA Audio

Réseau

- PCIE x1 Gigabit LAN 10/100/1000 Mo/s
- Realtek RTL8111H
- Prend en charge la fonction Wake-On-LAN
- Prend en charge la protection contre la foudre/les décharges électrostatiques
- Prend en charge la fonction d'économie d'énergie Ethernet 802.3az
- Prend en charge PXE

Connectique du panneau arrière

- 1 x port souris/clavier PS/2
- 1 x port D-Sub
- 1 x port DVI-D
- 1 x port HDMI
- 2 x ports USB 2.0 (Protection contre les décharges électrostatiques)
- 4 x ports USB 3.1 Gen1 (Protection contre les décharges électrostatiques)
- 1 x port RJ-45 LAN avec LED (LED ACT/LIEN et LED VITESSE)
- Connecteurs jack audio HD : Entrée ligne / haut-parleur avant / microphone

Stockage

- 4 x connecteurs SATA3 6,0 Gbit/s, prise en charge de RAID (RAID 0, RAID 1 et RAID 10), NCQ, AHCI et branchement à chaud
 - 1 x socket Ultra M.2, prend en charge les modules M.2 SATA3 6,0 Go/s type 2242/2260/2280 touche M et M.2 PCI Express jusqu'à Gen3 x4 (32 Go/s) (avec Summit Ridge, Raven Ridge et Pinnacle Ridge)*
- * Prend en charge les SSD NVMe comme disques de démarrage
* Prend en charge le kit ASRock U.2

Connecteur

- 1 x embase pour port d'impression
 - 1 x embase pour port COM
 - 1 x embase TPM
 - 1 x prise DEL d'alimentation et emplacement sur châssis
 - 1 x connecteur pour ventilateur de CPU (4 broches)
- * Le connecteur pour ventilateur de CPU prend en charge un ventilateur de CPU d'une puissance maximale de 1 A (12 W).
- 1 x connecteur pour ventilateur de châssis (3 broches)
- * Le connecteur pour ventilateur de châssis prend en charge un ventilateur de châssis d'une puissance maximale de 1 A (12 W).
- 1 x connecteur pour ventilateur de châssis /pompe à eau (4 broches) (contrôle de vitesse de ventilateur intelligent)
- * Le connecteur pour ventilateur de châssis /pompe à eau prend en charge un ventilateur de refroidisseur d'eau d'une puissance maximale de 2A (24W).
- * CHA_FAN1/WP peuvent détecter automatiquement si un ventilateur 3 broches ou 4 broches est utilisé.
- 1 x connecteur d'alimentation ATX 24 broches
 - 1 x connecteur d'alimentation 12 V 4 broches
 - 1 x connecteur audio panneau frontal
 - 2 x embases USB 2.0 (4 ports USB 2.0 pris en charge) (Protection contre les décharges électrostatiques)
 - 1 x embase USB 3.1 Gen1 (2 ports USB 3.1 Gen1 pris en charge) (Protection contre les décharges électrostatiques)

Système d'exploitation

- Microsoft® Windows® 10 64 bits

Specifiche

- Piattaforma**
- Fattore di forma Micro ATX
 - Design condensatore solido

- CPU**
- AMD AM4 Socket
 - Digi Power design
 - Supporto di CPU fino a 105W

- Chipset**
- AMD Promontory B450

- Memoria**
- Tecnologia memoria DDR4 Dual Channel
 - 2 x Alloggi DIMM DDR4
 - CPU serie AMD Ryzen (Pinnacle Ridge) supporto di memoria un-buffered* DDR4 3200+(OC)/2933/2667/2400/2133 ECC e non-ECC
 - Le CPU serie AMD Ryzen (Summit Ridge) supportano DDR4 3200+(OC)/2933 (OC)/2667/2400/2133 ECC e non ECC, senza buffer*
 - Le CPU serie AMD Ryzen (Raven Ridge) supportano DDR4 3200+(OC)/2933 (OC)/2667/2400/2133 non ECC, senza buffer*
- * Per le CPU serie Ryzen (Raven Ridge), è supportata solo la memoria ECC senza CPU PRO.
- * Per maggiori informazioni fare riferimento all'elenco dei supporti di memoria sul sito di ASRock. (<http://www.asrock.com/>)
- * Fare riferimento a pagina 11 per il supporto della frequenza massima DDR4 UDIMM.
- Capacità max. della memoria di sistema: 32 GB
 - Contatti d'oro 15µ negli alloggi DIMM

- Alloggio d'espansione**
- CPU serie AMD Ryzen (Summit Ridge e Pinnacle Ridge)**
- 1 x Alloggio PCI Express 3.0 x16 (PCIe2:modalità x16)*
- CPU serie AMD Ryzen (Raven Ridge)**
- 1 x Alloggio PCI Express 3.0 x16 (PCIe2:modalità x8)*

- * Supporto di SSD NVMe come disco d'avvio
- 1 x Alloggio PCI Express 2.0 x1

Grafica

- Grafica AMD Radeon™ serie Vega integrata nelle APU serie Ryzen*
- * Il supporto effettivo può variare in base alla CPU
- DirectX 12, Pixel Shader 5.0
- Memoria condivisa max. 2GB
- Tre opzioni di output grafico: D-Sub, DVI-D e HDMI
- Supporto di tre monitor
- Supporta HDMI con risoluzione massima fino a 4K x 2K (4096x2160) a 24Hz / (3840x2160) a 30Hz
- Supporta DVI-D con una risoluzione max. fino a 1920 x 1200 a 60 Hz
- Supporta D-Sub con una risoluzione max. fino a 2048x1536 a 60 Hz
- Supporto delle funzioni Auto Lip Sync, Deep Color (12bpc), xvYCC e HBR (High Bit Rate Audio) con porta HDMI (è necessario un monitor compatibile HDMI)
- Supporto di HDCP con le porte DVI-D e HDMI
- Supporto riproduzione 4K Ultra HD (UHD) sulla porta HDMI

Audio

- Audio HD 7.1 CH (codec audio Realtek ALC887)
- * Per configurare l'audio HD 7.1 canali, è necessario utilizzare un modulo pannello frontale audio HD ed attivare la funzione audio multicanale tramite il driver audio.
- Supporta protezione da sovratensione
- Cappucci audio ELNA

LAN

- 1 x PCIE LAN Gigabit 10/100/1000 Mb/s
- Realtek RTL8111H
- Supporto WOL (Wake-On-LAN)
- Supporta protezione da fulmini/scariche elettrostatiche
- Supporto Energy Efficient Ethernet 802.3az
- Supporto PXE

I/O pannello posteriore

- 1 x porta mouse/tastiera PS/2
- 1 x porta D-Sub
- 1 x porta DVI-D
- 1 x porta HDMI
- 2 x porte USB 2.0 (supporto protezione da scariche elettrostatiche)
- 4 x porte USB 3.1 Gen1 (supporto protezione da scariche elettrostatiche)
- 1 x porta LAN RJ-45 con LED (ACT/LINK LED e SPEED LED)
- Connettori audio HD: Ingresso linea / altoparlante frontale / microfono

**Archiviazi-
one**

- 4 x connettori SATA3 6,0 Gb/s, supporto RAID (RAID 0, RAID 1, e RAID 10), NCQ, AHCI e Hot Plug
- 1 x socket Ultra M.2, supporta il modulo M.2 SATA3 6,0 Gb/s di tipo M Key 2242/2260/2280 ed il modulo M.2 PCI Express fino a Gen3 x4 (32 Gb/s) (con Summit Ridge, Raven Ridge e Pinnacle Ridge)*

* Supporto di SSD NVMe come disco d'avvio

* Supporta kit ASRock U.2

Connettore

- 1 x connettore porta stampa
- 1 x connettore porta COM
- 1 x connettore TPM
- 1 x collegamento altoparlante e intrusione telaio
- 1 x connettore ventola CPU (4-pin)

* Il connettore ventola CPU supporta ventole CPU con potenza massima di 1 A (12 W).

- 1 x Connettore ventola telaio (3-pin)

* Il connettore ventola telaio supporta ventole telaio con potenza massima di 1 A (12 W).

- 1 x connettore ventola chassis/ventola pompa dell'acqua (4 pin) (Smart Fan Speed Control)

* Il connettore ventola telaio/pompa dell'acqua supporta ventole di sistemi di raffreddamento ad acqua di potenza massima di 2A (24W).

* CHA_FAN1WP sono in grado di rilevare se è in uso una ventola a 3 pin o 4 a pin.

- 1 x connettore alimentazione ATX 24 pin
- 1 x connettore alimentazione 12 V 4-pin
- 1 x connettore audio pannello frontale
- 2 x connettori USB 2.0 (supporto di 4 porte USB 2.0) (supporta protezione da scariche elettrostatiche)
- 1 x connettore USB 3.1 Gen1 (supporto di 2 porte USB 3.1 Gen1) (supporto protezione da scariche elettrostatiche)

SO

- Microsoft® Windows® 10 64 bit

Especificaciones

- Plataforma**
- Factor de forma Micro ATX
 - Diseño de condensador sólido

- CPU**
- AM4 con zócalo AMD
 - Digi Power design
 - Admite CPU de hasta 105 W

- Conjunto de chips**
- AMD Promontory B450

- Memoria**
- Tecnología de memoria DDR4 de doble canal
 - 2 x ranuras DIMM DDR4
 - Las CPU de la serie AMD (Pinnacle Ridge) admiten memoria sin búfer ECC y no ECC DDR4 3200+(OC)/2933/2667/2400/2133*
 - Las CPU de la serie AMD (Summit Ridge) admiten memoria sin búfer DDR4 3200+ (OC)*/2933 (OC)/2667/2400/2133 ECC y no ECC*
 - Las CPU de la serie AMD (Raven Ridge) admiten memoria sin búfer DDR4 3200+ (OC)*/2933 (OC)/2667/2400/2133 no ECC*

* Para CPU de la serie Ryzen (Raven Ridge), ECC solamente se admite con CPU PRO.

* Para obtener más información, consulte la lista de memorias compatibles en el sitio web de ASRock. (<http://www.asrock.com/>)

* Consulte la página 11 para conocer las frecuencias máximas compatibles de DDR4 UDIMM.

- Capacidad máxima de memoria del sistema: 32 GB
- Contacto 15µ Gold en ranuras DIMM

Ranura de expansión

CPU de la serie AMD Ryzen (Summit Ridge y Pinnacle Ridge)

- 1 x ranura PCI Express 3.0 x16 (PCIE2:modo x16)*

CPU de la serie AMD Ryzen (Raven Ridge)

- 1 x ranura PCI Express 3.0 x16 (PCIE2:modo x8)*

* Admite unidad de estado sólido de NVMe como disco de arranque

- 1 x ranura PCI Express 2.0 x1

Gráficos

- Tarjeta gráfica de la serie AMD Radeon™ Vega integrada en APU de la serie Ryzen*
- * El soporte real puede variar según la CPU
- DirectX 12, Pixel Shader 5.0
- Memoria máxima compartida de 2GB
- Tres opciones de salida de gráficos: D-Sub, DVI-D y HDMI
- Compatible con tres monitores
- Admite la tecnología HDMI con una resolución máxima de 4K x 2K (4096x2160) @ 24Hz / (3840x2160) @ 30Hz
- Compatible con DVI-D con máxima resolución hasta 1920x1200 @ 60Hz
- Admite D-Sub con una resolución máxima de 2048x1536 @ 60 Hz
- Admite Sincronización automática entre audio y vídeo, color profundo (12 bpc), xvYCC y HBR (audio de alta tasa de bits) con puerto HDMI (se necesita un monitor compatible con HDMI)
- Compatible con función HDCP con puertos DVI-D y HDMI
- Admite reproducción 4K Ultra HD (UHD) con puerto HDMI

Audio

- 7.1 Audio CH HD (Código de audio Realtek ALC887)
- *Para configurar 7.1 Audio CH HD, deberá utilizar un módulo del panel frontal de audio HD y habilitar la característica de audio multicanal a través del controlador de audio.
- Admite protección contra sobretensiones
- Tapas de audio ELNA

LAN

- PCIE x1 Gigabit LAN 10/100/1000 Mb/s
- Realtek RTL8111H
- Admite la función Reactivación de LAN
- Admite protección contra rayos y descargas electrostáticas (ESD)
- Admite Ethernet 802.3az de eficiencia energética
- Admite PXE

E/S en panel posterior

- 1 x puerto de ratón/teclado PS/2
- 1 x puerto D-Sub
- 1 x puerto DVI-D
- 1 x puerto HDMI
- 2 x Puertos USB 2.0 (admite protección contra descargas electrostáticas)
- 4 x Puertos USB 3.1 Gen1 (admite protección contra descargas electrostáticas)
- 1 x Puerto LAN RJ-45 con LED (LED DE ACTIVIDAD/ENLACE y LED DE VELOCIDAD)
- Conector de audio HD: Entrada de línea / Altavoz frontal / Micrófono

Almacenamiento

- 4 x conectores SATA3 de 6,0 Gb/s, compatible con RAID (RAID 0, RAID 1 y RAID 10), NCQ, AHCI y conexión en caliente
- 1 x Zócalo Ultra M.2 que admite el módulo SATA3 6,0 Gb/s M.2 de tipo 2242/2260/2280 con clave M y el módulo PCI Express M.2 hasta Gen3 x4 (32 Gb/s) (con Summit Ridge, Raven Ridge y Pinnacle Ridge)*

* Admite unidad de estado sólido de NVMe como disco de arranque

* Admite el Kit U.2 de ASRock

Conector

- 1 x Base de conexiones de puerto de impresión
- 1 x Base de conexiones de puerto COM
- 1 x Conector TPM
- 1 x cabezal de intrusión de chasis y de altavoces
- 1 x Conector para ventilador de la CPU (4 contactos)

* El conector para ventilador de la CPU admite ventilador de la CPU con una potencia de ventilador de 1 A (12 W) máxima.

- 1 x Conector para ventilador del chasis (3 contactos)

* El conector para ventilador del chasis admite el ventilador del chasis con una potencia de ventilador máxima de 1 A (12 W).

- 1 x Conector (4 contactos) para el ventilador de la bomba de agua/chasis (control de velocidad de ventilador inteligente)

* El conector para el ventilador de la bomba de agua o el chasis admite el ventilador de refrigerador por agua con una potencia de ventilador máxima de 2 A (24 W).

* CHA_FAN1/WP se pueden detectar automáticamente si se usa el ventilador de 3 o 4 contactos.

- 1 x conector de alimentación ATX de 24 contactos
- 1 x conector de alimentación de 12V de 4 contactos
- 1 x Conector de audio en el panel frontal
- 2 x Bases de conexiones USB 2.0 (admite 4 puertos USB 2.0) (Admite protección contra descargas electrostáticas)
- 1 x base de conexiones USB 3.1 Gen1 (admite 2 puertos USB 3.1 Gen1) (Admite protección contra descargas electrostáticas)

SO

- Microsoft® Windows® 10 64 bits

Технические характеристики

Платформа

- Форм-фактор Micro ATX
- Схема на основе твердотельных конденсаторов

ЦП

- AMD сокет AM4
- Digi Power design
- Поддерживаются ЦП мощностью до 105 Вт.

Чипсет

- AMD Promontory B450

Память

- Двухканальная память DDR4
 - 2 гнезда DDR4 DIMM
 - Процессоры AMD серии Ryzen (Pinnacle Ridge) поддерживают модули памяти DDR4 3200+(OC)/2933/2667/2400/2133, ECC, non-ECC и Unbuffered*
 - Процессоры AMD серии Ryzen (Summit Ridge) поддерживают модули памяти DDR4 3200+(OC)/2933 (OC)/2667/2400/2133, ECC, non-ECC и Unbuffered*
 - Процессоры AMD серии Ryzen (Raven Ridge) поддерживают модули памяти DDR4 3200+(OC)/2933 (OC)/2667/2400/2133, non-ECC и Unbuffered*
- *Для процессоров серии Ryzen (Raven Ridge) модуль памяти ECC поддерживается только процессорами PRO.
- * Дополнительная информация представлена в Списке совместимой памяти (Memory Support List) на веб-сайте ASRock. (<http://www.asrock.com/>)
- * Максимальные поддерживаемые частоты DDR4 UDIMM см на стр. 11.
- Максимальный объем ОЗУ: 32 ГБ
 - Позолоченные (15 мкм) контакты слотов DIMM

Слоты расширения

ЦП серии AMD Ryzen (Summit Ridge и Pinnacle Ridge)

- 1 слот PCI Express 3.0 x16 (PCIЕ2:режим x16)*

ЦП серии AMD Ryzen (Raven Ridge)

- 1 слот PCI Express 3.0 x16 (PCIЕ2:режим x8)*

* Поддерживаются в качестве загрузочных SSD-диски типа NVMe.

- 1 слот PCI Express 2.0 x1

Графическая подсистема

- Встроенный видеоадаптер AMD Radeon™ серии Vega в процессорах APU серии Ryzen*
- *Фактическая поддержка зависит от процессора
- DirectX 12, пиксельные шейдеры 5.0
- Максимальный объем общей памяти: 2 ГБ
- Три видеовыхода: D-Sub, DVI-D и HDMI
- Поддержка работы с тремя мониторами
- Поддерживается HDMI с максимальным разрешением до 4K x 2K (4096x2160) при частоте обновления 24 Гц (3840x2160 при 30 Гц)
- На выходе DVI-D поддерживается максимальное разрешение до 1920x1200 при частоте обновления 60 Гц
- Макс. разрешение на выходе D-Sub: 2048x1536 при частоте обновления 60 Гц
- Поддерживаются Auto Lip Sync, Deep Color (12 бит/цвет), xvYCC и HBR (High Bit Rate Audio) через порт HDMI (требуется соответствующий HDMI-монитор)
- Поддержка функции HDCP через порты DVI-D и HDMI
- Поддержка вывода видео с разрешением 4K Ultra HD (UHD) на порт HDMI

Звук

- 7.1-канальный звук высокой четкости (аудиокодек Realtek ALC887)
- *Для настройки 7.1-канального звук высокой четкости HD Audio используйте переднюю аудиопанель HD и активируйте функцию многоканального звука в аудиодрайвере.
- Защита от перепадов напряжения в электрической сети
- Конденсаторы для аудиосистем ELNA

LAN

- PCIe x1 Gigabit LAN 10/100/1000 Мбит/с
- Realtek RTL8111H
- Поддерживается пробуждение по ЛВС
- Молниезащита и защита от электростатических разрядов
- Поддерживается Energy Efficient Ethernet 802.3az
- Поддерживается PXE

Порты ввода-вывода на задней панели

- 1 порт PS/2 для мыши/клавиатуры
- 1 порт D-Sub
- 1 порт DVI-D
- 1 порт HDMI
- 2 порта USB 2.0 (с защитой от электростатических разрядов)
- 4 порта USB 3.1 Gen1 (с защитой от электростатических разрядов)
- 1 порт ЛВС RJ-45 с индикаторами («Активность/Соединение» и «Скорость»)
- Разъемы HD Audio: линейный вход / фронтальные AC / микрофон

Запоминающие устройства

- 4 порта SATA3 со скоростью передачи данных 6,0 Гб/с, поддержка RAID (RAID 0, RAID 1 и RAID 10), NCQ, AHCI и «горячего подключения».
- 1 слот Ultra M.2, поддерживает модуль M.2 SATA3 типа 2242/2260/2280 со скоростью обмена данными 6,0 Гбит/с с ключом M и модуль M.2 PCI Express до версии Gen3 x4 (32 Гбит/с с ЦП Summit Ridge, Raven Ridge и Pinnacle Ridge)*

* Поддерживаются в качестве загрузочных SSD-диски типа NVMe.

* Поддерживается комплект ASRock U.2

Разъемы

- 1 колодка порта принтера
- 1 колодка COM-порта
- 1 колодка TPM
- 1 колодка с разъемами датчика вскрытия корпуса и динамика
- 1 разъем для вентилятора охлаждения ЦП, 4-контактный

* Разъем процессорного вентилятора поддерживает вентилятор с потребляемым током не более 1 А (12 Вт).

- 1 разъем для корпусного вентилятора (3-контактный)

* Разъем корпусного вентилятора поддерживает вентилятор с потребляемым током не более 1 А (12 Вт).

- 1 разъем для корпусного вентилятора или водяной помпы (4-контактный) (смарт-регулятор скорости вентилятора)

* Разъем для корпусного вентилятора или водяной помпы поддерживает вентилятор водяного охлаждения с потребляемым током не более 2 А (24 Вт).

* Для разъемов CHA_FAN1/WP автоматически определяется тип подключенного вентилятора: 3- или 4-контактный.

- 1 разъем питания ATX, 24-контактный
- 1 разъем питания 12 В, 4-контактный
- 1 аудиоразъем для передней панели
- 2 колодки USB 2.0 (4 порта USB 2.0, с защитой от электростатических разрядов)
- 1 колодка USB 3.1 Gen1 (2 порта USB 3.1 Gen1) (с защитой от электростатических разрядов)

Операционные системы

- Microsoft® Windows® 10 (64-разрядная)

Especificações

- Plataforma**
- Micro ATX Form Factor
 - Design de condensador sólido

- CPU**
- Soquete AMD AM4
 - Digi Power design
 - Suporta CPU até 105W

- Chipset**
- AMD Promontory B450

- Memória**
- Tecnologia de memória DDR4 de dois canais
 - 2 x Slots DDR4 DIMM
 - CPUs série AMD (Pinnacle Ridge) suporta DDR4 3200+(OC)/2933/2667/2400/2133 ECC & não-ECC, sem memória intermediária*
 - CPUs série AMD (Summit Ridge) suporta DDR4 3200+(OC)/2933 (OC)/2667/2400/2133 ECC & não ECC, sem memória intermediária*
 - CPUs série AMD (Raven Ridge) suporta DDR4 3200+(OC)/2933 (OC)/2667/2400/2133 não ECC, sem memória intermediária*
- * Para CPUs série Ryzen (Raven Ridge), ECC só é suportado com CPUs PRO.
- * Por favor, consulte a Lista de Suporte de Memória no site da ASRock para obter mais informação. (<http://www.asrock.com/>)
- * Por favor consulte a página 11 para suporte de frequência máxima DDR4 UDIMM.
- Capacidade máxima da memória do sistema: 32GB
 - Contato em Ouro 15µ nos slots DIMM

- Slot de expansão**
- CPUs AMD Série Ryzen (Summit Ridge e Pinnacle Ridge)**
- 1 x Slot PCI Express 3.0 x16 (PCIE2:modo x16)*
- CPUs AMD Série Ryzen (Raven Ridge)**
- 1 x Slot PCI Express 3.0 x16 (PCIE2:x8 modo)*

* Suporta NVMe SSD nos discos de inicialização

- 1 x slots PCI Express 2.0 x1

Gráficos

- AMD Radeon™ Integrado Série Vega Gráficas na Série Ryzen APU*
- * Suporte atual pode variar por CPU
- DirectX 12, Pixel Shader 5.0
- Memória compartilhada máxima de 2GB
- Três opções de saída de gráficos: D-Sub, DVI-D e HDMI
- Suporta configuração com três monitores
- Suporta HDMI com resolução máx. até 4K x 2K (4096x2160) @ 24Hz / (3840x2160) @ 30Hz
- Suporta DVI-D com resolução máxima de até 1920x1200 @ 60Hz
- Suporta D-Sub com resolução máxima de até 2048x1536 @ 60Hz
- Suporta Auto sincronização labial, Deep Color (12bpc), xvYCC e HBR (High Bit Rate Audio) com porta HDMI (É necessário um monitor compatível com HDMI)
- Suporta HDCP com Portas DVI-D e HDMI
- Suporta reprodução HD Ultra (UHD) 4K com Porta HDMI

Áudio

- Áudio 7.1 CH HD com proteção de conteúdo (Codec de áudio Realtek ALC887)
- *Para configurar Áudio 7.1 CH HD, é necessário usar um módulo de áudio de painel frontal HD e habilitar o recurso de áudio multi-canal pelo driver de áudio.
- Suporta Proteção de Sobreintensão
- Fones de Áudio ELNA

LAN

- LAN Gigabit 10/100/1000 Mb/s PCIE x1
- Realtek RTL8111H
- Suporta Wake-On-LAN
- Oferece Suporte à Proteção de Relâmpago/ESD
- Suporta Energy Efficient Ethernet 802.3az
- Suporta PXE

E/S do painel posterior

- 1 x Porta PS/2 para mouse/teclado
- 1 x Porta D-Sub
- 1 x Porta DVI-D
- 1 x Porta HDMI
- 2 x Portas USB 2.0 (Suporta Proteção ESD)
- 4 x Portas USB 3.1 Gen1 (Suporta Proteção ESD)
- 1 x Porta LAN RJ-45 com LED (LED ACT/LINK e LED DE VELOCIDADE)
- Fichas de áudio HD: Entrada de Linha / Autofalante Frontal / Microfone

Armazenamento

- 4 x Conectores SATA3 6,0 Gb/s, suporta RAID (RAID 0, RAID 1, e RAID 10), NCQ, AHCI e Conexão a Quente
- 1 x Soquete Ultra M.2, suporta M chave digite 2242/2260/2280 módulo M.2 SATA3 6,0 Gb/s e M.2 PCI Express até Gen3 x4 (32 Gb/s) (com Summit Ridge, Raven Ridge e Pinnacle Ridge)*

* Suporta NVMe SSD nos discos de inicialização

* Suporta Kit U.2 ASRock

Conector

- 1 x Suporte Porta Impressão
- 1 x Suporte porta COM
- 1 x Plataforma TPM
- 1 x Intrusão do Chassi e Cabeçote de Autofalante
- 1 x Conector da ventoinha da CPU (4 pinos)

* O Conector do Ventilador de CPU suporta o ventilador de CPU de alimentação máxima 1A do ventilador (12W).

- 1 x Conector da ventoinha do Gabinete (3 pinos)

* O Conector do Ventilador do Chassi suporta o ventilador do chassi de potência do ventilador máxima de 1A (12W).

- 1 x Conector do ventilador do chassi/Ventilador da Bomba de Água (4 pinos) (Controle de Velocidade de Ventoinha Inteligente)

* O Conector do Ventilador do Chassi/Bomba de Água suporta o ventilador refrigerador a água de potência do ventilador máxima de 2A (24W).

* CHA_FAN1/WP podem detectar automaticamente se ventoinha de 3 pinos ou 4 pinos está em uso.

- 1 x Conector alimentação ATX 24 pinos
- 1 x Conector de energia 4-pinos 12V
- 1 x Conector de áudio do painel frontal
- 2 x Plataformas USB 2.0 (Suporta 4 portas USB 2.0) (Suporta Proteção ESD)
- 1 x Plataforma USB 3.1 Gen1 (Suporta 2 portas USB 3.1 Gen1) (Suporta Proteção ESD)

SO

- Microsoft® Windows® 10 64-bit

Specyfikacje

Platforma

- Współczynnik kształtu Micro ATX
- Konstrukcja kondensatorami stałymi

CPU

- AMD AM4 Socket
- Digi Power design
- Obsługa CPU do 105 W

Chipset

- AMD Promontory B450

Pamięć

- Technologia pamięci Dual Channel DDR4
- 2 x gniazda DDR4 DIMM
- Seria CPU AMD Ryzen (Pinnacle Ridge) z obsługą DDR4 3200+(OC)/2933/2667/2400/2133 ECC i nie-ECC, pamięć niebuforowana*
- Seria CPU AMD Ryzen (Summit Ridge) z obsługą DDR4 3200+(OC)/2933(OC)/2667/2400/2133 ECC i nie-ECC, pamięć niebuforowana*
- Seria CPU AMD Ryzen (Raven Ridge) z obsługą DDR4 3200+(OC)/2933(OC)/2667/2400/2133 nie-ECC, pamięć niebuforowana*

* Dla serii CPU Ryzen (Raven Ridge), ECC jest obsługiwana tylko z CPU PRO.

* Sprawdź listę obsługiwanej pamięci na stronie internetowej ASRock w celu uzyskania dalszych informacji. (<http://www.asrock.com/>)

* Sprawdź stronę 11 w celu uzyskania informacji o maksymalnej obsługiwanej częstotliwości DDR4 UDIMM.

- Maks. wielkość pamięci systemowej: 32GB
- 15µ połączane styki w gniazdach DIMM

Gniazdo rozszerzenia

Procesor serii AMD Ryzen (Summit Ridge oraz Pinnacle Ridge)

- 1 x gniazdo PCI Express 3.0 x 16 (tryb PCIE2:x16)*

Procesor serii AMD Ryzen (Raven Ridge)

- 1 x gniazdo PCI Express 3.0 x 16 (tryb PCIE2:x8)*

* Obsługa SSD NVMe, jako dysków rozruchowych

- 1 x gniazdo PCI Express 2.0 x1

Grafika

- Zintegrowana karta graficzna AMD Radeon™ serii Vega w APU serii Ryzen*

* Rzeczywista obsługa zależy od CPU

- DirectX 12, Pixel Shader 5.0
- Maks. współdzielona pamięć 2GB
- Opcje trzech wyjść graficznych: D-Sub, DVI-D i HDMI
- Obsługa trzech monitorów
- Obsługa HDMI z maks. rozdzielczością do 4K x 2K (4096x2160) przy 24Hz / (3840x2160) przy 30Hz
- Obsługa DVI-D z maks. rozdzielczością do 1920x1200 przy 60Hz
- Obsługa D-Sub z maks. rozdzielczością do 2048x1536 przy 60Hz
- Obsługa Auto Lip Sync, Deep Color (12bpc), xvYCC i HBR (High Bit Rate Audio) z portami HDMI (Wymagany monitor zgodny z HDMI)
- Obsługa HDCP z portami DVI-D i HDMI
- Obsługa odtwarzania 4K Ultra HD (UHD) z portem HDMI

Audio

- Dźwięk HD 7.1 CH (kodek audio Realtek ALC887)

* Aby skonfigurować dźwięk 7.1 CH HD wymagane jest użycie modułu panelu czołowego HD i włączenie funkcji dźwięku wielokanałowego za pośrednictwem sterownika audio.

- Obsługa zabezpieczenia przed przepięciami
- Nasadki audio ELNA

LAN

- 1 x PCIE Gigabit LAN 10/100/1000 Mb/s
- Realtek RTL8111H
- Obsługa Wake-On-LAN
- Obsługa zabezpieczenia przed wyładowaniami atmosferycznymi/ESD
- Obsługa Energy Efficient Ethernet 802.3az
- Obsługa PXE

Tylny panel**Wejścia/Wyjścia**

- 1 x port myszy/klawiatury PS/2
- 1 x port D-Sub
- 1 x port DVI-D
- 1 x port HDMI
- 2 x porty USB 2.0 (Obsługa zabezpieczenia ESD)
- 4 x porty USB 3.1 Gen1 (Obsługa zabezpieczenia ESD)
- 1 x porty LAN RJ-45 z LED (LED ACT/LINK i LED SPEED)
- Gniazda audio HD: Wejście liniowe / Głośnik przedni / Mikrofon

Przechowywanie

- 4 x złącza SATA3 6,0 Gb/s, obsługa RAID (RAID 0, RAID 1 i RAID 10), NCQ, AHCI i Hot Plug
 - 1 x gniazdo Ultra M.2, obsługa M Key typu 2242/2260/2280 modułu M.2 SATA3 6,0 Gb/s i modułu M.2 PCI Express do Gen3 x4 (32 Gb/s) (z Summit Ridge, Raven Ridge oraz Pinnacle Ridge)*
- * Obsługa SSD NVMe, jako dysków rozruchowych
- * Obsługa ASRock U.2 Kit

Złącze

- 1 x złącze główkowe portu drukarki
 - 1 x złącze główkowe portu COM
 - 1 x złącze główkowe TPM
 - 1 x złącze główkowe naruszenia obudowy i głośnika
 - 1 x złącze wentylatora CPU (4-pinowe)
- * Złącze wentylatora CPU obsługuje wentylator CPU maksymalnym prądem zasilania wentylatora 1A (12W).
- 1 x złącze wentylatora obudowy (3-pinowe)
- * Złącze wentylatora obudowy obsługuje wentylator obudowy maksymalnym prądem zasilania wentylatora 1 A (12 W).
- 1 x złącza wentylatora obudowy/pompy wodnej (4-pinowe) (Inteligentne sterowanie prędkością obrotową wentylatora)
- * Złącze wentylatora obudowy/pompy wodnej obsługuje wentylator układu chłodzenia maksymalnym prądem zasilania wentylatora 2 A (24 W).
- * CHA_FAN1/WP może automatycznie wykrywać, jeśli używany jest wentylator 3-pinowy lub 4-pinowy.
- 1 x 24 pinowe złącze zasilania ATX
 - 1 x 4 pinowe złącze zasilania 12 V
 - 1 x złącze audio na panelu przednim
 - 2 x złącza główkowe USB 2.0 (Obsługa 4 portów USB 2.0) (Obsługa zabezpieczenia ESD)
 - 1 x porty główkowe USB 3.1 Gen1 (obsługa 2 portów USB 3.1 Gen1) (obsługa zabezpieczenia ESD)

System operacyjny

- Microsoft® Windows® 10 64-bitowy

규격

플랫폼

- Micro ATX 폼 팩터
- 솔리드 콘덴서 구조

CPU

- AMD AM4 Socket
- Digi Power design
- 최대 105W 의 CPU 지원

칩세트

- AMD Promontory B450

메모리

- 듀얼 채널 DDR4 메모리 기술
- DDR4 DIMM 슬롯 2 개
- AMD Ryzen 시리즈 CPU(Pinnacle Ridge) 는 DDR4 3200+(OC)/2933/2667/2400/2133 ECC 및 비 ECC, 비버퍼링 메모리를 지원합니다.*
- AMD Ryzen 시리즈 CPU(Summit Ridge) 는 DDR4 3200+(OC)/2933 (OC)/2667/2400/2133 ECC 및 비 ECC, 비버퍼링 메모리를 지원합니다.*
- AMD Ryzen 시리즈 CPU(Raven Ridge) 는 DDR4 3200+(OC)/2933 (OC)/2667/2400/2133 ECC 및 비 ECC, 비버퍼링 메모리를 지원합니다.*

* Ryzen Series CPU(Raven Ridge) 의 경우, ECC 는 PRO CPU 에 서만 지원합니다.

* 추가 정보를 원하시면 ASRock 웹사이트에 있는 메모리 지원 목록을 참조하십시오. (<http://www.asrock.com/>)

* DDR4 UDIMM 최대 주파수 지원은 11 페이지를 참조하십시오.

- 시스템 메모리 최대 용량 : 32GB
- DIMM 슬롯에 15 μ Gold Contact 장착

확장 슬롯

AMD Ryzen 시리즈 CPU(Summit Ridge 및 Pinnacle Ridge)

- PCI Express 3.0 x16 슬롯 1 개 (PCIe2:x16 모드)*

AMD Ryzen 시리즈 CPU(Raven Ridge)

- PCI Express 3.0 x16 슬롯 1 개 (PCIe2:x8 모드)*

* NVMe SSD 를 부팅 디스크로 사용 가능하도록 지원

- PCI Express 2.0 x1 슬롯 1 개

그래픽

- Ryzen Series APU 의 통합형 AMD Radeon™ Vega Series 그래픽 *
- * 실제 지원은 CPU 에 따라 다를 수 있음
- DirectX 12, Pixel Shader 5.0
- 최대 공유 메모리 2GB
- 그래픽 출력 옵션 세 개 : D-Sub, DVI-D 및 HDMI
- 삼중 모니터 지원
- HDMI 지원 (최대 해상도 4K x 2K (4096x2160) @ 24Hz / (3840x2160) @ 30Hz)
- DVI-D 지원 (최대 해상도 1920x1200 @ 60Hz)
- D-Sub 지원 (최대 해상도 2048x1536 @ 60Hz)
- Auto Lip Sync, Deep Color (12bpc), xvYCC 및 HBR (High Bit Rate Audio)(HDMI 포트 포함) 지원 (HDMI 호환 모니터 필요)
- DVI-D 및 HDMI 포트를 이용한 HDCP 지원
- HDMI 포트를 이용한 4K Ultra HD(UHD) 재생 지원

오디오

- 7.1 CH HD 오디오 (Realtek ALC887 오디오 코덱)
- * 7.1 CH HD 오디오를 구성하려면 HD 전면 패널 오디오 모듈을 사용하고 다채널 오디오 기능을 오디오 드라이버로 활성화해야 합니다.
- 서비 보호 지원
- ELNA 오디오 캡

LAN

- PCIE 1 개, Gigabit LAN 10/100/1000 Mb/s
- Realtek RTL8111H
- Wake-On-LAN 지원
- 번개 /ESD 보호 지원
- 절전형 이더넷 802.3az 지원
- PXE 지원

후면 패널 I/O

- PS/2 마우스 / 키보드 포트 1 개
- D-Sub 포트 1 개
- DVI-D 포트 1 개
- HDMI 포트 1 개
- USB 2.0 포트 2 개 (ESD 보호 지원)
- USB 3.1 Gen1 포트 4 개 (ESD 보호 지원)
- LED 장착 RJ-45 LAN 포트 1 개 (ACT/LINK LED 및 SPEED LED)
- HD 오디오 잭 : 라인 입력 / 전면 스피커 / 마이크

저장 장치

- SATA3 6.0 Gb/s 커넥터 4 개가 RAID(RAID 0, RAID 1 및 RAID 10), NCQ, AHCI 및 핫 플러그를 지원합니다.
- 울트라 M.2 소켓 1 개, M 키 타입 2242/2260/2280 M.2 SATA3 6.0 Gb/s 모듈 및 Gen3 M.2 PCI Express 모듈 (Summit Ridge, Raven Ridge 및 Pinnacle Ridge 탑재) 을 4 개 (32 Gb/s) 까지 지원 *
- * NVMe SSD 를 부팅 디스크로 사용 가능하도록 지원
- * ASRock U.2 키트 지원

커넥터

- 인쇄 포트 헤더 1 개
- COM 포트 헤더 1 개
- TPM 헤더 1 개
- 새시 침입 및 스피커 헤더 1 개
- CPU 팬 커넥터 (4 핀) 1 개
- * CPU 팬 커넥터는 팬 전력이 최대 1A(12W) 인 CPU 팬을 지원합니다.
- 새시 팬 커넥터 (3 핀) 1 개
- * 새시 팬 커넥터는 팬 전력이 최대 1A(12W) 인 새시 팬을 지원합니다.
- 새시 / 워터 펌프 팬 커넥터 (4 핀) 1 개 (스마트 팬 속도 제어)
- * 새시 / 워터 펌프 팬 커넥터는 팬 전력이 최대 2A(24W) 인 수랭식 쿨러 팬을 지원합니다.
- * 3 핀 또는 4 핀 팬이 사용 중인 경우, CHA_FAN1/WP 가 자동으로 감지할 수 있습니다.
- 24 핀 ATX 전원 커넥터 1 개
- 4 핀 12V 전원 커넥터 1 개
- 전면 패널 오디오 커넥터 1 개
- USB 2.0 헤더 2 개 (USB 2.0 포트 4 개 지원) (ESD 보호 지원)
- USB 3.1 Gen1 헤더 1 개 (USB 3.1 Gen1 포트 2 개 지원) (ESD 보호 지원)

OS

- Microsoft® Windows® 10 64- 비트

仕様

プラットフォーム

- マイクロ ATX フォームファクター
- 固体コンデンサ設計

CPU

- AMD AM4 ソケット
- Digi Power design
- 最大 105W までの CPU に対応

チップセット

- AMD Promontory B450

メモリ

- デュアルチャンネル DDR4 メモリ機能
 - 2 x DDR4 DIMM スロット
 - AMD Ryzen シリーズ CPU (Pinnacle Ridge) は、DDR4 3200+ (OC)/2933/2667/2400/2133 ECC および非 ECC、アンバッファードメモリに対応します *
 - AMD Ryzen シリーズ CPU (Summit Ridge) は DDR4 3200+(OC)/2933 (OC)/2667/2400/2133 ECC、および、ノン ECC、アンバッファードメモリに対応します。*
 - AMD Ryzen シリーズ CPU (Raven Ridge) は DDR4 3200+(OC)/2933 (OC)/2667/2400/2133 ノン ECC、アンバッファードメモリに対応します。*
- * Ryzen シリーズ CPU (Raven Ridge) の場合、ECC は PRO CPU のみに対応します。
- * 詳細については、ASRock ウェブサイトのメモリーサポート一覧を参照してください。 (<http://www.asrock.com/>)
- * DDR4 UDIMM 最大周波数サポートについては 11 ページを参照してください。
- システムメモリの最大容量：32GB
 - DIMM スロットに 15 μ ゴールドコンタクトを採用

拡張スロット

AMD Ryzen シリーズ CPU (Summit Ridge および Pinnacle Ridge)

- 1 x PCI Express 3.0 x16 スロット (PCIe2:x16 モード)*

AMD Ryzen シリーズ CPU (Raven Ridge)

- 1 x PCI Express 3.0 x16 スロット (PCIe2:x8 モード)*

* 起動ディスクとして NVMe SSD に対応

- 1 x PCI Express 2.0 x1 スロット

グラフィックス

- AMD Radeon™ Vega シリーズグラフィックスを Ryzen シリーズ APU に統合*

*実際のサポートは CPU によって異なることがあります

- DirectX 12, Pixel Shader 5.0
- 最大共有メモリ 2GB
- 3つのグラフィックス出力オプション: D-Sub, DVI-D, HDMI
- 3台のモニターに対応
- HDMI に対応、最大解像度 4K x 2K (4096x2160) @ 24Hz / (3840x2160) @ 30Hz
- DVI-D に対応、最大解像度 1920x1200 @60Hz
- D-Sub をサポート。最大解像度 2048x1536 @60Hz
- HDMI ポートでオトリップシンク、ディープカラー (12bpc)、xvYCC、および、HBR (高ビットレートオーディオ) に対応 (HDMI 対応モニターが必要です)
- DVI-D ポートと HDMI ポートで HDCP に対応
- HDMI ポートで 4K Ultra HD (UHD) 再生に対応

オーディオ

- 7.1 CH HD オーディオ (Realtek ALC887 Audio Codec)

*7.1 CH HD オーディオを設定するためには、HD フロントパネルのオーディオモジュールを使用し、オーディオドライバを通してマルチチャンネルオーディオ機能を有効にする必要があります。

- サージ保護に対応
- ELNA 製オーディオコンデンサ

LAN

- PCIE x1 ギガビット LAN 10/100/1000 Mb/ 秒
- Realtek RTL8111H
- Wake-On-LAN (ウェイク オン ラン) に対応
- 雷 / 静電気放電 (ESD) 保護に対応
- エネルギー効率のよいイーサネット 802.3az をサポート
- PXE をサポート

リアパネル I/O

- 1 x PS/2 マウス / キーボードポート
- 1 x D-Sub ポート
- 1 x DVI-D ポート
- 1 x HDMI ポート
- 2 x USB 2.0 ポート (静電気放電 (ESD) 保護に対応)
- 4 x USB 3.1 Gen1 ポート (静電気放電 (ESD) 保護に対応)
- LED 付き 1 x RJ-45 LAN ポート (ACT/LINK LED と SPEED LED)
- HD オーディオジャック: ラインイン / フロントスピーカー / マイク

ストレージ

- 4 x SATA3 6.0 Gb/s コネクタ、RAID(RAID 0、RAID 1、RAID 10)、NCQ、AHCI およびホットプラグ機能に対応
- 1 x ウルトラ M.2 ソケット、M Key タイプ 2242/2260/2280 M.2 SATA3 6.0 Gb/s モジュール、および、最大 Gen3 x4 (32 Gb/s) (Summit Ridge、Raven Ridge および Pinnacle Ridge の場合) までの M.2 PCI Express モジュールに対応 *
- * 起動ディスクとして NVMe SSD に対応
- * ASRock U.2 キットに対応

コネクタ

- 1 x プリントポートヘッダー
- 1 x COM ポートヘッダー
- 1 x TPM ヘッダー
- 1 x シャーシインテルージョンとスピーカーヘッダー
- 1 x CPU ファンコネクタ(4 ピン)
- * CPU ファンコネクタは最大 1A (12W) の電力の CPU ファンに対応します。
- 1 x シャーシファンコネクタ(3 ピン)
- * シャーシファンコネクタは最大 1A (12W) の出力のシャーシファンに対応します。
- 1 x シャーシ/ウォーターポンプファンコネクタ(4 ピン) (スマートファン速度制御)
- * シャーシ/ウォーターポンプファンコネクタは最大 2A (24W) の出力の水冷ファンに対応します。
- * CHA_FAN1/WP は 3 ピンまたは 4 ピンファンが使用されているかどうかを自動検出できます。
- 1 x 24 ピン ATX 電源コネクタ
- 1 x 4 ピン 12V 電源コネクタ
- 1 x 前面パネルオーディオコネクタ
- 2 x USB 2.0 ヘッダー(4 つの USB 2.0 ポートに対応) (静電気放電(ESD)保護に対応)
- 1 x USB 3.1 Gen1 ヘッダー(2 つの USB 3.1 Gen1 ポートに対応) (静電気放電(ESD)保護に対応)

OS

- Microsoft® Windows® 10 64-bit

规格

- 平台**
- Micro ATX 规格尺寸
 - 稳固的电容器设计

- CPU**
- AMD AM4 Socket
 - Digi Power design
 - 支持最高 105W 的 CPU

- 芯片集**
- AMD Promontory B450

- 内存**
- 双通道 DDR4 内存技术
 - 2 x DDR4 DIMM 槽
 - AMD Ryzen 系列 CPU (Pinnacle Ridge) 支持 DDR4 3200+(OC)/2933/2667/2400/2133 ECC 及非 ECC，非缓冲内存 *
 - AMD Ryzen 系列 CPU (Summit Ridge) 支持 DDR4 3200+(OC)/2933 (OC)/2667/2400/2133 ECC 及非 ECC，非缓冲内存 *
 - AMD Ryzen 系列 CPU (Raven Ridge) 支持 DDR4 3200+(OC)/2933 (OC)/2667/2400/2133 非 ECC，非缓冲内存 *
- * 对于 Ryzen 系列 CPU (Raven Ridge)，仅 PRO CPU 支持 ECC。
- * 请参阅华擎网站上的 Memory Support List（内存支持列表）了解详情。（<http://www.asrock.com/>）
- * 请参考第 11 页了解 DDR4 UDIMM 最大支持频率。
- 支持系统内存最大容量：32GB
 - DIMM 插槽中 15 μ 金触点

- 扩充槽**
- AMD Ryzen 系列 CPU (Summit Ridge 和 Pinnacle Ridge)**
- 1 x PCI Express 3.0 x16 插槽（PCIe2：x16 模式）*
- AMD Ryzen 系列 CPU (Raven Ridge)**
- 1 x PCI Express 3.0 x16 插槽（PCIe2：x8 模式）*

* 支持 NVMe SSD 用作启动盘

- 1 x PCI Express 2.0 x1 槽

图形

- Ryzen 系列 APU 中的集成 AMD Radeon™ Vega 系列图形 *
- * 实际支持可能视 CPU 而变化
- DirectX 12、Pixel Shader 5.0
- 最大共享内存 2GB
- 3 个图形输出选项：D-Sub、DVI-D 和 HDMI
- 支持三台显示器
- 支持 HDMI，24Hz 时最大分辨率可达 4K x 2K (4096x2160)/30Hz 时可达 (3840x2160)
- 支持 DVI-D，60Hz 时最大分辨率达 1920x1200
- 支持 D-Sub，60Hz 时最大分辨率达 2048x1536
- 通过 HDMI 端口（需要兼容的 HDMI 显示器）支持 Auto Lip Sync、Deep Color (12bpc)、xvYCC 和 HBR（高位速率音频）
- 通过 DVI-D 和 HDMI 端口支持 HDCP
- 通过 HDMI 端口支持 4K 超高清 (UHD) 播放

音频

- 7.1 CH 高清音频 (Realtek ALC887 音频编解码器)
- * 要配置 7.1 CH 高清音频，需要使用高清前面板模块和通过音频驱动程序启用多通道音频功能。
- 支持电涌保护
- ELNA 音频电容

LAN

- PCIE x1 Gigabit LAN 10/100/1000 Mb/s
- Realtek RTL8111H
- 支持 Wake-On-LAN（网上唤醒）
- 支持雷电 /ESD 保护
- 支持高效以太网 802.3az
- 支持 PXE

后面板 I/O

- 1 x PS/2 鼠标 / 键盘端口
- 1 x D-Sub 端口
- 1 x DVI-D 端口
- 1 x HDMI 端口
- 2 x USB 2.0 端口 (支持 ESD 保护)
- 4 x USB 3.1 Gen1 端口 (支持 ESD 保护)
- 1 x RJ-45 LAN 端口，带 LED (ACT/LINK LED 和 SPEED LED)
- 高清音频插孔：线路输入 / 前扬声器 / 麦克风

存储

- 4 x SATA3 6.0 Gb/s 接口，支持 RAID (RAID 0、RAID 1 和 RAID 10)、NCQ、AHCI 和热插拔
 - 1 x 超级 M.2 接口，支持 M Key 类型 2242/2260/2280 M.2 SATA3 6.0 Gb/s 类型模块和 M.2 PCI Express 模块（最高 Gen3 x4 (32 Gb/s) (Summit Ridge、Raven Ridge 和 Pinnacle Ridge)）*
- * 支持 NVMe SSD 用作启动盘
* 支持华擎 U.2 套件

接口

- 1 x 打印端口接脚
 - 1 x COM 端口接头
 - 1 x TPM 接脚
 - 1 x 机箱侵入和扬声器接脚
 - 1 x CPU 风扇接口 (4 针)
- * CPU 风扇接口支持最高 1A (12W) 功率的 CPU 风扇。
• 1 x 机箱风扇接口 (3 针)
- * 机箱风扇接口支持功率最大为 1A (12W) 的机箱风扇。
• 1 x 机箱 / 水泵风扇接口 (4 针) (智能风扇速度控制)
- * 机箱 / 水泵风扇接口支持功率最大为 2A (24W) 的水冷风扇。
* CHA_FAN1/WP 可以自动检测 3 针脚或 4 针脚风扇是否在使用。
- 1 x 24 针 ATX 电源接口
 - 1 x 4 针 12V 电源接口
 - 1 x 前面板音频接口
 - 2 x USB 2.0 接脚 (支持 4 个 USB 2.0 端口，支持 ESD 保护)
 - 1 x USB 3.1 Gen1 接脚 (支持 2 个 USB 3.1 Gen1 端口，支持 ESD 保护)

操作系统

- Microsoft® Windows® 10 64-bit

电子信息产品污染控制标示

依据中国发布的「电子信息产品污染控制管理办法」及 SJ/T 11364-2006「电子信息产品污染控制标示要求」，电子信息产品应进行标示，藉以向消费者揭露产品中含有的有毒有害物质或元素不致发生外泄或突变从而对环境造成污染或对人身、财产造成严重损害的期限。依上述规定，您可于本产品之印刷电路板上看见图一之标示。图一中之数字为产品之环保使用期限。由此可知此主板之环保使用期限为 10 年。



图一

有毒有害物质或元素的名称及含量说明

若您欲了解此产品的有毒有害物质或元素的名称及含量说明，请参照以下表格及说明。

部件名称	有害物质或元素					
	铅 (Pb)	镉 (Cd)	汞 (Hg)	六价铬 (Cr(VI))	多溴联苯 (PBB)	多溴二苯醚 (PBDE)
印刷电路板及电子组件	X	O	O	O	O	O
外部信号连接头及线材	X	O	O	O	O	O

O: 表示该有毒有害物质在该部件所有均质材料中的含量均在 SJ/T 11363-2006 标准规定的限量要求以下。

X: 表示该有毒有害物质至少在该部件的某一均质材料中的含量超出 SJ/T 11363-2006 标准规定的限量要求，然该部件仍符合欧盟指令 2002/95/EC 的规范。

备注: 此产品所标示之环保使用年限，系指在一般正常使用状况下。

規格

平台

- Micro ATX 尺寸
- 固態電容設計

CPU

- AMD AM4 Socket
- Digi Power design
- 支援最高 105W CPU

晶片組

- AMD Promontory B450

記憶體

- 雙通道 DDR4 記憶體技術
- 2 x DDR4 DIMM 插槽
- AMD Ryzen 系列 CPU (Pinnacle Ridge) 支援 DDR4 3200+(OC)/2933/2667/2400/2133 ECC & 非 ECC、無緩衝記憶體 *
- AMD Ryzen 系列 CPU (Summit Ridge) 支援 DDR4 3200+(OC)/2933 (OC)/2667/2400/2133 ECC & 非 ECC、無緩衝記憶體 *
- AMD Ryzen 系列 CPU (Raven Ridge) 支援 DDR4 3200+(OC)/2933 (OC)/2667/2400/2133 非 ECC、無緩衝記憶體 *

* 若使用 Ryzen 系列 CPU (Raven Ridge)，僅 PRO CPU 支援 ECC。

* 如需更多資訊，請參閱華擎網站上的記憶體支援表。
(<http://www.asrock.com/>)

* 關於 DDR4 UDIMM 最高頻率支援，請參閱第 11 頁。

- 最大系統記憶體容量：32GB
- 15 μ 特厚鍍金插槽

擴充插槽

AMD Ryzen 系列 CPU (Summit Ridge 及 Pinnacle Ridge)

- 1 x PCI Express 3.0 x16 插槽 (PCIe2：x16 模式) *

AMD Ryzen 系列 CPU (Raven Ridge)

- 1 x PCI Express 3.0 x16 插槽 (PCIe2：x8 模式) *

* 支援 NVMe SSD 作為開機磁碟

- 1 x PCI Express 2.0 x1 插槽

顯示卡

- 整合式 AMD Radeon™ Vega Series Graphics 內建於 Ryzen 系列 APU*
- * 實際支援可能隨 CPU 改變
- DirectX 12、Pixel Shader 5.0
- 最大共用記憶體 2GB
- 三個圖形輸出選項：D-Sub、DVI-D 及 HDMI
- 支援三台顯示器
- 支援最高可達 4K x 2K (4096x2160) @ 24Hz / (3840x2160) @ 30Hz 解析度的 HDMI
- 支援最高達 1920x1200 @ 60Hz 解析度的 DVI-D
- 最高支援 2048x1536 @ 60Hz 解析度的 D-Sub
- 支援使用 HDMI 連接埠（需相容於 HDMI 監視器）的 Auto Lip Sync、Deep Color (12bpc)、xvYCC 及 HBR（高位元率音訊）
- 支援含 DVI-D 及 HDMI 連接埠的 HDCP
- 支援使用 HDMI 連接埠進行 4K Ultra HD (UHD) 播放

音訊

- 7.1 CH HD 音訊 (Realtek ALC887 音訊轉碼器)
- * 若要設定 7.1 CH HD 音訊，必須使用 HD 前面板音訊模組，並透過音訊驅動程式啟用多聲道音訊功能。
- 支援突波保護
- ELNA 音響級電容

LAN

- PCIe x1 Gigabit LAN 10/100/1000 Mb/s
- Realtek RTL8111H
- 支援網路喚醒
- 支援雷擊／靜電保護
- 支援 802.3az EEE 節能乙太網路
- 支援 PXE

後面板 I/O

- 1 x PS/2 滑鼠／鍵盤連接埠
- 1 x D-Sub 連接埠
- 1 x DVI-D 連接埠
- 1 x HDMI 連接埠
- 2 x USB 2.0 連接埠（支援靜電保護）
- 4 x USB 3.1 Gen1 連接埠（支援靜電保護）
- 1 x RJ-45 LAN 連接埠，含 LED（ACT/LINK LED 及 SPEED LED）
- HD 音訊插孔：線路輸入／前置喇叭／麥克風

儲存裝置

- 提供 4 x SATA3 6.0 Gb/s 接頭，支援 RAID（RAID 0、RAID 1 與 RAID 10）、NCQ、AHCI 及熱插拔
- 1 x Ultra M.2 插座，支援 M Key 型 2242/2260/2280 M.2 SATA3 6.0 Gb/s 模組與 M.2 PCI Express 模組（最高可達 Gen3 x4 (32 Gb/s) 類型（配備 Summit Ridge、Raven Ridge 及 Pinnacle Ridge）*
 - * 支援 NVMe SSD 作為開機磁碟
 - * 支持華擎 U.2 套件

接頭

- 1 x 列印連接埠排針
- 1 x COM 連接埠排針
- 1 x TPM 排針
- 1 x 機殼防護及喇叭排針
- 1 x CPU 風扇接頭 (4-pin)
 - * CPU 風扇接頭支援最高 1A (12W) 風扇功率的 CPU 風扇。
- 1 x 機殼風扇接頭 (3-pin)
 - * 機殼風扇接頭支援最高 1A (12W) 風扇功率的機殼風扇。
- 1 x 機殼／水冷幫浦風扇接頭 (4-pin)（智慧型風扇速度控制）
 - * 機殼／水冷幫浦風扇接頭支援最高 2A (24W) 風扇功率的水冷風扇。
 - * 如果 3-pin 或 4-pin 風扇使用中，可自動偵測 CHA_FAN1/WP。
- 1 x 24 pin ATX 電源接頭
- 1 x 4 pin 12V 電源接頭
- 1 x 前面板音訊接頭
- 2 x USB 2.0 排針（支援 4 個 USB 2.0 連接埠）（支援靜電保護）
- 1 x USB 3.1 Gen1 排針（支援 2 個 USB 3.1 Gen1 連接埠）（支援靜電保護）

作業系統

- Microsoft® Windows® 10 64-bit

Spesifikasi

- Platform**
- Bentuk dan Ukuran Micro ATX
 - Desain Kapasitor Solid

- CPU**
- Soket AMD AM4
 - Desain Digi Power
 - Mendukung CPU hingga 105W

- Chipset**
- AMD Promontory B450

- Memori**
- Teknologi Memori DDR4 Dua Saluran
 - 2 x Slot DIMM DDR4
 - CPU seri AMD Ryzen (Pinnacle Ridge) mendukung DDR4 3200+(OC)/2933/2667/2400/2133 ECC & non-ECC, memori tanpa buffer*
 - CPU seri AMD Ryzen (Summit Ridge) mendukung DDR4 3200+(OC)/2933 (OC)/2667/2400/2133 ECC & non-ECC, memori tanpa buffer*
 - CPU seri AMD Ryzen (Raven Ridge) mendukung DDR4 3200+(OC)/2933 (OC)/2667/2400/2133 non-ECC, memori tanpa buffer*
- * Untuk CPU Seri Ryzen (Raven Ridge), ECC hanya didukung dengan CPU PRO.
- * Lihat Daftar Dukungan Memori di situs web ASRock untuk informasi selengkapnya. (<http://www.asrock.com/>)
- * Lihat halaman 11 untuk dukungan frekuensi maksimum DDR4 UDIMM.
- Kapasitas maksimum memori sistem: 32GB
 - 15µ Bidang Kontak Berwarna Emas di Slot DIMM

Slot Ekspansi CPU Seri AMD Ryzen (Summit Ridge, dan Pinnacle Ridge)

- 1 x Slot PCI Express 3.0 x16 (PCIe2:x16 mode)*

CPU Seri AMD Ryzen (Raven Ridge)

- 1 x Slot PCI Express 3.0 x16 (PCIe2:x8 mode)*

* Mendukung SSD NVMe sebagai disk boot

- 1 x Slot PCI Express 2.0 x1

Grafis

- Grafis AMD Radeon™ Terpadu Seri Vega dalam APU Seri Ryzen*
- * Dukungan sebenarnya mungkin beragam berdasarkan CPU
- DirectX 12, Pixel Shader 5.0
- Maksimum memori bersama 2GB
- Tiga pilihan output grafis: D-Sub, DVI-D, dan HDMI
- Mendukung Tiga Monitor
- Mendukung HDMI dengan resolusi maksimum hingga 4K x 2K (4096x2160) @ 24Hz/(3840x2160) @ 30Hz
- Mendukung DVI-D dengan resolusi maksimum hingga 1920x1200 @ 60Hz
- Mendukung D-Sub dengan resolusi maksimum hingga 2048x1536 @ 60Hz
- Mendukung Auto Lip Sync, Kedalaman Warna (12bpc), xvYCC, dan HBR (Audio High Bit Rate) dengan Port HDMI (memerlukan monitor yang kompatibel dengan HDMI)
- Mendukung HDCP dengan port DVI-D dan HDMI
- Mendukung pemutaran Ultra HD 4K (UHD) dengan Port HDMI

Audio

- Audio HD 7.1 CH (Realtek ALC887 Audio Codec)
- * Untuk mengkonfigurasi Audio HD 7.1 CH, modul audio panel depan HD harus digunakan dan fitur audio multisaluran harus diaktifkan melalui driver audio.
- Mendukung Perlindungan dari Lonjakan Arus
- ELNA Audio Caps

LAN

- 1 x PCIE Gigabit LAN 10/100/1000 Mb/s
- Realtek RTL8111H
- Mendukung Wake-On-LAN
- Mendukung Perlindungan dari Petir/ESD
- Mendukung Ethernet 802.3az Hemat Energi
- Mendukung PXE

I/O Panel Belakang

- 1 x Port Mouse/Keyboard PS/2
- 1 x Port D-Sub
- 1 x Port DVI-D
- 1 x Port HDMI
- 2 x Port USB 2.0 (Mendukung Perlindungan dari ESD)
- 4 x Port USB 3.1 Gen1 (Mendukung Perlindungan dari ESD)
- 1 x Port LAN RJ-45 dengan LED (LED ACT/LINK dan LED SPEED)
- Soket Audio HD: Saluran Masuk/Speaker Depan/Mikrofon

Penyimpanan

- 4 x Konektor SATA3 6,0 Gb/s, mendukung RAID (RAID 0, RAID 1, dan RAID 10), NCQ, AHCI dan Hot Plug
 - 1 x Soket Ultra M.2, mendukung modul M Key tipe 2242/2260/2280 M.2 SATA3 6,0 Gb/s dan modul M.2 PCI Express hingga Gen3 x4 (32 Gb/s) (dengan Summit Ridge, Raven Ridge and Pinnacle Ridge)*
- * Mendukung SSD NVMe sebagai disk boot
* Mendukung Kit U.2 ASRock

Konektor

- 1 x Header Port Printer
 - 1 x Header Port COM
 - 1 x Header TPM
 - 1 x Intrusi Chassis dan Header Speaker
 - 1 x Konektor Kipas CPU (4-pin)
- * Konektor Kipas CPU mendukung kipas CPU dengan daya kipas maksimum 1A (12W).
- 1 x Konektor Kipas Chassis (3-pin)
- * Konektor Kipas Sasis mendukung kipas sasis dengan daya kipas maksimum 1A (12W).
- 1 x Konektor Kipas Chassis/Pompa Air (4-pin) (Kontrol Kecepatan Kipas Pintar)
- * Konektor Kipas Sasis/Pompa Air mendukung kipas berpendingin air dengan daya kipas maksimum 2A (24W).
- * CHA_FAN1/WP dapat mendeteksi otomatis jika kipas 3-pin atau 4-pin sedang digunakan.
- 1 x Konektor Daya ATX 24 pin
 - 1 x Konektor Daya 4 pin 12V
 - 1 x Konektor Audio Panel Depan
 - 2 x Header USB 2.0 (Mendukung 4 port USB 2.0) (Mendukung Perlindungan dari ESD)
 - 1 x Header USB 3.1 Gen1 (Mendukung 2 port USB 3.1 Gen1) (Mendukung Perlindungan dari ESD)

OS

- Microsoft® Windows® 10 64-bit

Contact Information

If you need to contact ASRock or want to know more about ASRock, you're welcome to visit ASRock's website at <http://www.asrock.com>; or you may contact your dealer for further information. For technical questions, please submit a support request form at <https://event.asrock.com/tsd.asp>

ASRock Incorporation

2F., No.37, Sec. 2, Jhongyang S. Rd., Beitou District,

Taipei City 112, Taiwan (R.O.C.)

ASRock EUROPE B.V.

Bijsterhuizen 11-11

6546 AR Nijmegen

The Netherlands

Phone: +31-24-345-44-33

Fax: +31-24-345-44-38

ASRock America, Inc.

13848 Magnolia Ave, Chino, CA91710

U.S.A.

Phone: +1-909-590-8308

Fax: +1-909-590-1026

DECLARATION OF CONFORMITY

Per FCC Part 2 Section 2.1077(a)



Responsible Party Name: ASRock Incorporation

Address: 13848 Magnolia Ave, Chino, CA91710

Phone/Fax No: +1-909-590-8308/+1-909-590-1026

hereby declares that the product

Product Name : Motherboard

Model Number : B450M-HDV

Conforms to the following specifications:

FCC Part 15, Subpart B, Unintentional Radiators

Supplementary Information:

This device complies with part 15 of the FCC Rules. Operation is subject to the following two conditions: (1) This device may not cause harmful interference, and (2) this device must accept any interference received, including interference that may cause undesired operation.

Representative Person's Name: James

Signature:

A handwritten signature in black ink, appearing to read 'James', written over a horizontal line.

Date : May 12, 2017

EU Declaration of Conformity



For the following equipment:

Motherboard

(Product Name)

B450M-HDV / ASRock

(Model Designation / Trade Name)

ASRock Incorporation

(Manufacturer Name)

2F., No.37, Sec. 2, Jhongyang S. Rd., Beitou District, Taipei City 112, Taiwan (R.O.C.)

(Manufacturer Address)

EMC — Directive 2014/30/EU (from April 20th, 2016)

EN 55022:2010/AC:2011 Class B

EN 55024:2010/A1:2015

EN 55032:2012+AC:2013 Class B

EN 61000-3-3:2013

EN 61000-3-2:2014

LVD — Directive 2014/35/EU (from April 20th, 2016)

EN 60950-1 : 2011+ A2: 2013

EN 60950-1 : 2006/A12: 2011

RoHS — Directive 2011/65/EU

CE marking

(EU conformity marking)



ASRock EUROPE B.V.

(Company Name)

Bijsterhuizen 1111 6546 AR Nijmegen The Netherlands

(Company Address)

Person responsible for making this declaration:

(Name, Surname)

A.V.P

(Position / Title)

June 22, 2018

(Date)

P/N: 15G062102000AK V1.0