

Package overview

1.1 Monitor & accessories

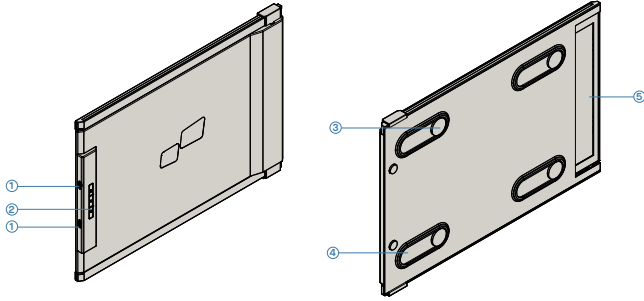

Duex Plus

- 1 Interchangeable usb Type-C ports Backcharging port And signal port
- 2 Menu Buttons
- 3 Magnetic Plates
- 4 Metallic Plates
- 5 Screen

Accessories

- 1 USB Type-C cable with USB-A to C adapter
- 2 Magnetic Plates
- 3 Adhesive stickers

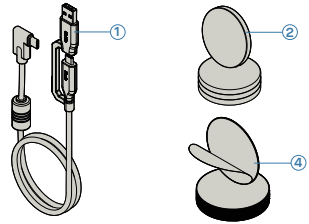

2 Driver installation guide

When using USB C to connect, driver installation is not necessary.

2.1 Windows installation guide

Connect Windows Laptop to Mobile Pixels Duex Plus Monitor, wait 20 secs and the monitor should turn on. In the event the monitor does not turn on, please follow the steps below:

1. Please download the correct windows driver from:
2. Double click and launch the installer. Click "Yes" in the window below.

WWW.MOBILEPIXELS.US/PAGES/DOWNLOAD-DRIVERS

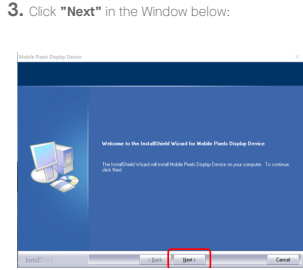

4. Please select "I accept the terms of the license agreement" and click Next

5. Please select "Yes, I want to restart my computer now" and click Finish

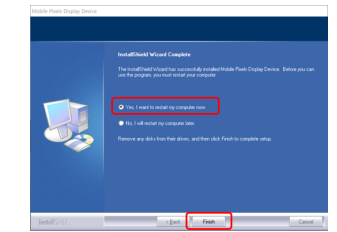
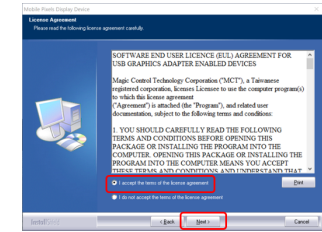

2.2 Apple OS installation guide

Do not plug the Mobile Pixels Device into your mac before executing the driver installation

1. Please download the Mac driver from the link below. Run the "Mobile_pixels_3.3-2021-04-19.dmg" file to load the drivers to the mac folder
2. Click Mobile_Pixels_Graphics_Driver-3.3-2021-04-19.pkg, please follow the instructions to install the device driver.

WWW.MOBILEPIXELS.US/PAGES/DOWNLOAD-DRIVERS



3. The system should pop-up a screen "System Extension Blocked" after installation asks the user to enable these extensions for the first time. Click "Open Security Preference" to go setting.

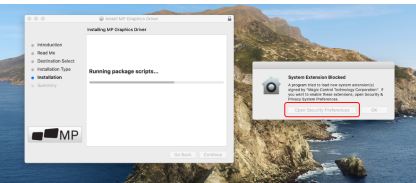

Important: This warning is not always shown. Even if it is not shown, for new installations the user must "Allow" to install the Mobile Pixels driver and restart the laptop

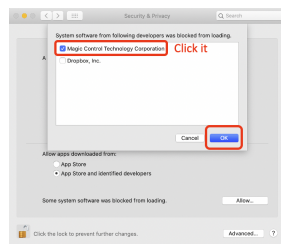

4. (After System Reboot) Connect Mobile Pixels device to Mac computer, a screen recording prompt should pop up "Click Open System Preferences"

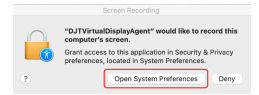

5. Go to System Preferences > Security & Privacy > Privacy
6. Click on the "Lock" to make changes
7. Scroll and select "Screen Recording" and check "DJVirtualDisplayAgent"
8. Click on the Lock to save changes Click "Quit Now" and restart the laptop.

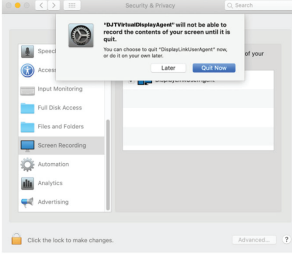
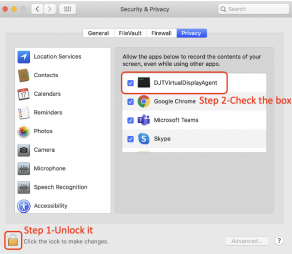

3 Attachment Guide

Clean laptop surface with included alcohol pad. Wait 10 secs for surface to dry.

Instruction for laptops under 16" monitor

Center and square the template on the back of your laptop.

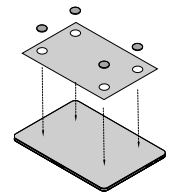

Place/ adhere magnet(s) into unfilled holes and press Down to make sure it is firmly adhered. then remove template and mount your MP monitor

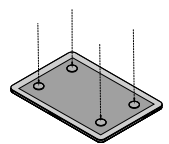

Instruction for laptops above 16" monitor

Decide whether you want the screen to extend left or right Align the edge of the template to the edge of the laptop on the side you chose.

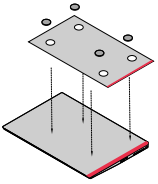

Place/Adhere magnet(s) into unfilled holes and press Down to make sure it is firmly adhered, then proceed to remove the template and mount your MP monitor

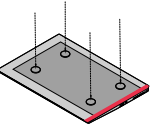

4 Monitor positioning guide

4.1 Attachment mode

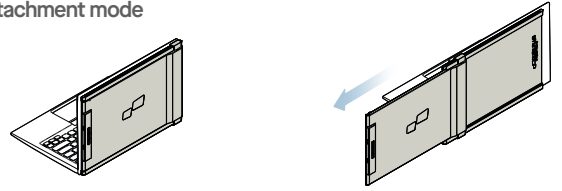

1. Open the laptop monitor.
2. Slide Duex Plus and swivel the screen. *USB Cable omitted

4.2 Rotated monitor

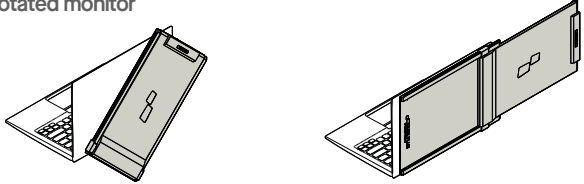

1. To use it on the other side, rotate 180 degrees. Snap into the back of the laptop.
2. Slide it and you are ready to work.

4.3 Portrait Mode

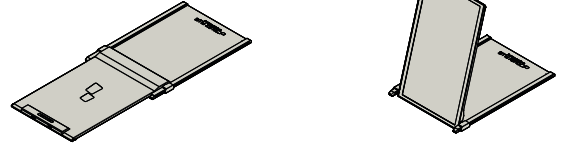

1. Slide Duex Plus Rotate around 110° degrees
2. Connect Duex Plus to the Pc and use it in portrait mode Go to Display settings to rotate display *USB Cable omitted

4.4 Presentation Mode



1. Slide Duex Plus and rotate it
2. To access presentation mode, simply swivel Duex Plus 180 degrees to the back of the laptop. *USB Cable omitted

4.5 Nintendo Switch & Android mode Duex Plus Only

1. First connect the original power cable of your switch/android device to Duex Plus, then connect Switch/Android device to Duex Plus

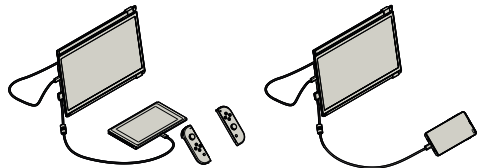

5.1 Duplicate Mode to Extend Mode for Windows

-Right click on your desktop while Duex Plus is connected and choose "Display Setting"
 -Then you should either see this screen or the one at next Section

-If you have a duplicate screen and want to change it to extend mode, click on the "Duplicate these displays" from the drop down box

-When the drop down box is opened, choose "Extend these displays"
 -Then click "Apply"
 -Now you are in Extend Mode

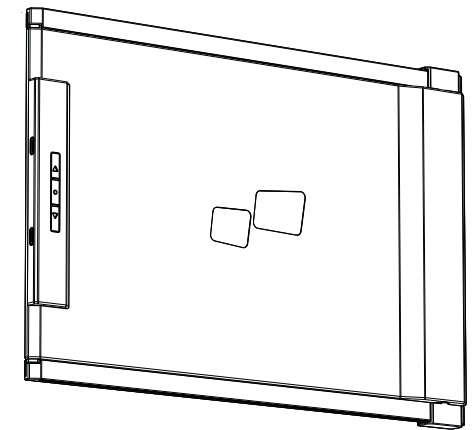
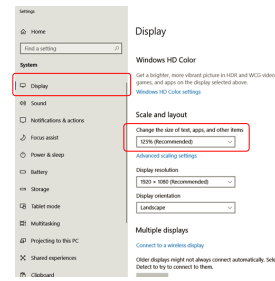
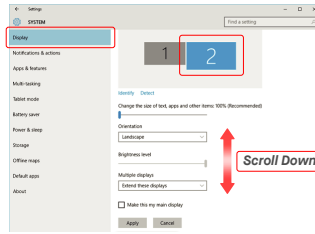
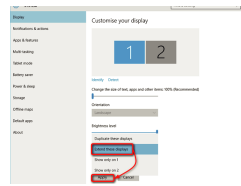
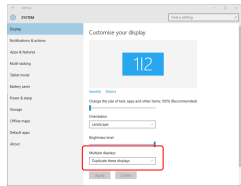

5.2 Duplicate Mode to Extend Mode for Mac OS

- Click on system preference and go to Displays

- Checking the "Mirror Displays" box will switch between duplicate and extend mode for Duex Plus

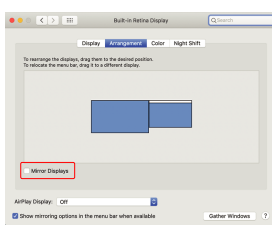

5.3 Rotate Display and Layout set up for Windows

If you are already in "Extend mode" and want to use Duex Plus on the left

1. First click on the 2nd screen icon
2. Then open the Orientation drop down box and change it from "Landscape" to "Landscape (flipped)": Choose "Portrait" for Portrait Mode".
3. Then click "Apply"

-Now your screen is upside down and ready to be use on the left with 1 extra step.

-Move the 2nd display icon from the right to the left of the 1st display by simply "Drag and Drop" it.
 -Click "Apply" to finish the setting of the lay out.

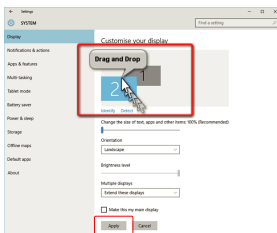
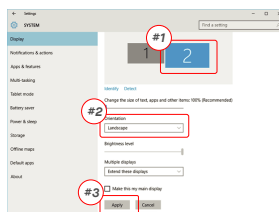

5.4 Rotate Display and Layout set up for Mac OS

- To position the display on either left or right, simply drag and drop it to the side you want.

- To rotate the display, go to the Duex Plus display window and choose the suitable "Rotation" options.

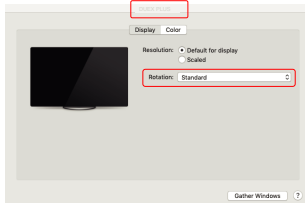
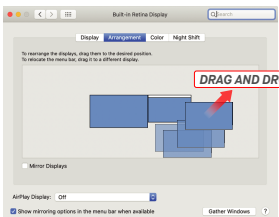

5.5 Change Display Settings to Adjust Content Size for Windows

1. To adjust content size on Duex Plus monitor, first click on the number "2" monitor under Display setting.
2. Scroll down and look for "scale and layout" options
3. Default size of text is set at 125% and user can increase it up to 175% or reduce back to 100% base on user preference.

5.6 Change Display Settings to Adjust Content Size for Mac OS

1. Click System Preferences
2. Click Displays

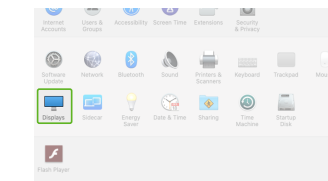
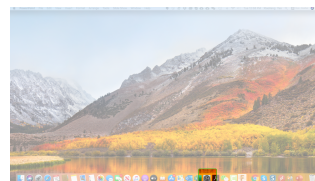

3. Hold down "Option" key and click "Scaled"
4. Select the resolution that fits your need

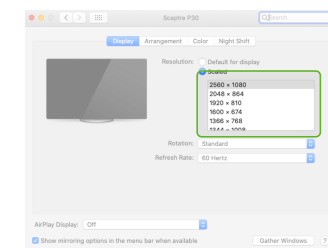
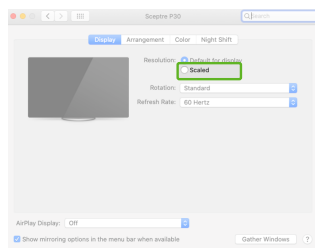

6 Technical Information

Model	Duex Plus
Size	13.3 In
Weight	675g
Thickness	Thinnest 6.45mm/ 0.25 In
Hybrid Signals	Yes
Eye-Care Mode	Yes
Auto-Rotation	Yes
Nintendo Switch	Yes
Android Phones	Yes

*Specifications are subject to change without notice.

DUEX PLUS

Portable Laptop Monitor

User Guide

Copyright © 2021 MOBILE PIXELS INC. All Rights Reserved. No part of this manual, including the products and software described in it, may be reproduced, transmitted, transcribed, stored in a retrieval system, or translated into any language in any form or by any means, except those permitted in writing by MOBILE PIXELS INC. or (2) the serial number of the product, destroyed or missing. MOBILE PIXELS INC. PROVIDES THIS MANUAL "AS IS" WITHOUT WARRANTY OF ANY KIND, EITHER EXPRESS OR IMPLIED, INCLUDING BUT NOT LIMITED TO THE IMPLIED WARRANTIES OF MERCHANTABILITY OR FITNESS FOR A PARTICULAR PURPOSE. IN NO EVENT SHALL MOBILE PIXELS INC. DIRECTORS, OFFICERS, EMPLOYEES OR AGENTS BE LIABLE FOR ANY INDIRECT, SPECIAL, INCIDENTAL, OR CONSEQUENTIAL DAMAGES (INCLUDING DAMAGES FOR LOSS OF PROFITS, LOSS OF BUSINESS, LOSS OF USE OR DATA, INTERRUPTION OF BUSINESS AND THE LIKE) EVEN IF MOBILE PIXELS INC. HAS BEEN ADVISED OF THE POSSIBILITY OF SUCH DAMAGES ARISING FROM ANY DEFECT OR ERROR IN THIS MANUAL OR PRODUCT. SPECIFIC INFORMATION CONTAINED IN THIS MANUAL ARE FOR INFORMATIONAL USE ONLY AND ARE SUBJECT TO CHANGE AT ANY TIME WITHOUT NOTICE, AND SHOULD NOT BE CONSTRUED AS A COMMITMENT BY MOBILE PIXELS INC. MOBILE PIXELS INC. ASSUMES NO RESPONSIBILITY OR LIABILITY FOR ANY ERRORS OR INACCURACIES THAT MAY APPEAR IN THIS MANUAL, INCLUDING THE PRODUCTS AND SOFTWARE DESCRIBED IN IT, AND/OR ANY TERMS APPEARING IN THIS MANUAL MAY OR MAY NOT BE REGISTERED TRADEMARKS OR COPYRIGHTS OF THEIR RESPECTIVE COMPANIES, AND ARE USED ONLY FOR IDENTIFICATION OR EXPLANATION AND TO THE OWNERS' BENEFIT, WITHOUT INTENT TO INFRINGE.

6.2 Safety and Handling

IMPORTANT SAFETY INFORMATION

Carefully go through the user manual and other documentation before setting up the DUEX PLUS. If any part is broken or damaged, do not try to open DUEX PLUS or attempt to fix it yourself, please contact the retailer, a qualified service technician or email us directly at contact@mobilepixels.us. Store DUEX PLUS under appropriate conditions, avoid exposure to extreme heat, moisture and dust. We recommend you to place DUEX PLUS on a stable surface and keep your DUEX PLUS in a sleeve to protect it during transport. Never spill liquid of any kind onto the surface or into the openings of the DUEX PLUS. Do not spray any cleaner on the screen to avoid an electric shock. If your DUEX PLUS gets wet, unplug all cables and reconnect till the DUEX PLUS is completely dry. Carefully unplug all cables before cleaning DUEX PLUS. Clean with a soft, dry, lint-free cloth. To ensure satisfactory experience, use the DUEX PLUS with recommended display size of your laptop. Please disconnect the cables when you reverse the position of your laptop, rotate 180°. About a vector normal to the backplane, and re-couple to the backplane of the laptop computer.

CHOKING HAZARD

DUEX PLUS and accessories contain small parts that may present a choking hazard to small children, please keep them out of reach from small children.

MEDICAL DEVICE INTERFERENCE

The DUEX PLUS contains magnets. The DUEX PLUS also contains components and radios that emit electromagnetic fields. It may interfere with personal medical devices, e.g. pacemakers or defibrillators. Keep a safe distance between the DUEX PLUS and your medical device. Consult a physician or medical device manufacturer for specific details of your medical device. Stop using DUEX PLUS if the interference is observed with your personal medical devices. Items with magnetically-stored data such as credit cards and hard drives may be sensitive to magnetic or electromagnetic fields, hence should be kept at a distance from DUEX PLUS.

FCC COMPLIANCE STATEMENT

This device complies with Part 15 of the FCC Rules. Operation is subject to the following two conditions: 1_This device may not cause harmful interference. 2_This device must accept any interference received including interference that may cause undesired operation. Note: This equipment has been tested and found to comply with the limits for a Class B digital device, pursuant to Part 15 of the FCC Rules. These limits are designed to provide reasonable protection against harmful interference in a residential installation. This equipment generates, uses, and can radiate radio frequency energy, and if not installed and used in accordance with the instructions, may cause harmful interference to radio communications. However, there is no guarantee that interference will not occur in a particular installation. If this equipment does cause harmful interference to radio or television reception, which can be determined by turning the equipment off and on, the user is encouraged to try to correct the interference by one or more of the following measures: 1_Reorient or relocate the receiving antenna. 2_Increase the separation between the equipment and receiver. 3_Connect the equipment into an outlet on a circuit different from that to which the receiver is connected. 4_Consult the dealer or an experienced radio/TV technician for help.

WARRANTY

Mobile Pixels INC warrants this product for a period of 1 year upon the original date of purchase. Product or service warranty will not be extended to any losses or damages that are due to improper installation, misuse, neglect, modification, alteration by non-authorized third party, improper environment, or other irregularities.

SUPPORT

For detailed troubleshooting information, contact: CONTACT@MOBILEPIXELS.US