



Newland

SCANNING MADE SIMPLE



android
enterprise
recommended

MT90 Orca Pro II Mobile Computer User Guide

Disclaimer

© 2020 Newland Auto-ID Tech. Co., Ltd. All rights reserved.

Please read through the manual carefully before using the product and operate it according to the manual. It is advised that you should keep this manual for future reference.

Do not disassemble the device or remove the seal label from the device, doing so will void the product warranty provided by Newland Auto-ID Tech. Co., Ltd.

All pictures in this manual are for reference only and actual product may differ. Regarding the product modification and update, Newland Auto-ID Tech. Co., Ltd. reserves the right to make changes to any software or hardware to improve reliability, function, or design at any time without notice. The information contained herein is subject to change without prior notice.

The products depicted in this manual may include software copyrighted by Newland Auto-ID Tech. Co., Ltd or third party. The user, corporation or individual, shall not duplicate, in whole or in part, distribute, modify, decompile, disassemble, decode, reverse engineer, rent, transfer or sublicense such software without prior written consent from the copyright holders.

This manual is copyrighted. No part of this publication may be reproduced, distributed or used in any form without written permission from Newland.

Risk Warning Regarding Unauthorized System Updates:

You should use the Newland-provided tool to update this product's system. Modifying system files through installing a third-party ROM system or using any cracking method may result in product malfunction or data loss and this will void your warranty.

Newland Auto-ID Tech. Co., Ltd. reserves the right to make final interpretation of the statement above.

Newland Auto-ID Tech. Co., Ltd.

No.1, Rujiang West Rd., Mawei, Fuzhou, Fujian, China 350015

<http://www.newlandaidc.com>

Revision History

Version	Description	Date
V1.0.0	Initial Release.	2020-05-09
V1.0.1	Updated with Newland App User Guide Description	2020-05-28
V1.0.2	Updated with the MT90 Images	2020-11-12

Contents

Chapter 1 About This Guide	1
Introduction	1
Documentation Set.....	1
Chapter Descriptions.....	1
More Information.....	2
Chapter 2 Getting Started	3
Introduction	3
Unpacking	3
Accessories (Optional)	3
Getting Started	4
The MT90.....	4
USB Charging Cradle	6
Ethernet Charging Cradle	6
Installing the Battery	7
Removing the Battery	7
Charging the Battery	8
Keypad.....	9
Communicating with PC.....	10
Installing the MicroSD Card/SIM Card	11
Chapter 3 Basics	12
Introduction	12
Switching On/Rebooting/Switching Off the MT90.....	12
Locking/Unlocking the MT90	13
Home Screen	13
Status Icons	14
Uninstalling App	15
Date & Time	16
Display	16
Ringtones.....	17
Restoring Factory Settings.....	17
Language & Input Method.....	18
Floating Button Settings	19
Shortcuts to Apps	19
Widgets	20

Chapter 4 Scanning Barcodes	21
Introduction	21
Scanning 1D Barcode	21
Scanning 2D Barcode	22
Programming Scanner	23
Enable Scan.....	23
Output Mode	24
Scan Mode	24
Scan Trigger.....	25
Prefix & Suffix.....	26
Good Read Indicator	27
Encoding	27
Data Edit	28
Broadcast-output Settings.....	29
Symbologies.....	29
Chapter 5 Bluetooth	31
Chapter 6 Wi-Fi	32
Introduction	32
Join a Wi-Fi Network	32
Wi-Fi Settings	33
Metered.....	34
Proxy.....	34
IP Settings.....	35
Add Network.....	36
Wi-Fi Preferences	38
WLAN Band	39
WLAN Advanced Mode:.....	39
Advanced Setting.....	40
Saved Networks	40
Wi-Fi Data Usage.....	41
Chapter 7 Mobile Network	42
Introduction	42
Mobile Network Settings	42
APN Settings.....	43
Chapter 8 Others	45
Camera	45
GPS	46

NFC.....	46
Memory Cleanup.....	47
Key Map.....	48
Chapter 9 Admin Tool.....	49
Introduction	49
Launching the Admin Tool	49
Chapter 10 Whitelist Manager	53
Introduction	53
Logging in to Whitelist Manager	53
Chapter 11 System Update	54
Online Update	54
Local Update.....	54
Chapter 12 App Development Guide.....	58
Development Environment.....	58
Use of Non-Standard Interfaces.....	58
Chapter 13 Maintenance & Troubleshooting.....	59
Introduction	59
Important Safety & Handling Information	59
Disassembly and Retrofit	59
External Power Supply.....	59
Abnormal Situation.....	59
Drop Damage.....	59
LCD Screen	59
Stacking Heavy Objects.....	59
Mounting Location.....	59
Wireless Functionalities	60
Use & Maintenance.....	60
Battery Safety Guidelines.....	60
Troubleshooting.....	61

Chapter 1 About This Guide

Introduction

This guide provides instructions for programming and operating the NLS-MT90 portable data collector (hereinafter referred to as “the MT90” or “the terminal”).

Documentation Set

The documentation set for the MT90 includes:

- ❖ **NLS-MT90 Portable Data Collector Quick Start:** Describes how to get the NLS-MT90 up and running.
- ❖ **NLS-MT90 Portable Data Collector User Guide:** Describes how to program and use the NLS-MT90.
- ❖ **Newland APP User Guide:** Describes how to install/uninstall, or use the APPs developed by Newland (For GMS Version Only)

Chapter Descriptions

- ❖ *Chapter 1 About This Guide* Provides general description of this manual.
- ❖ *Chapter 2 Getting Started* Provides information on getting the MT90 up and running for the first time.
- ❖ *Chapter 3 Basics* Describes how to program the MT90 for the use of its basic features.
- ❖ *Chapter 4 Scanning Barcodes* Provides the instructions as to how to scan 1D/2D barcodes and how to program the scanner.
- ❖ *Chapter 5 Bluetooth* Explains how to use Bluetooth functionality.
- ❖ *Chapter 6 Wi-Fi* Explains how to use Wi-Fi functionality.
- ❖ *Chapter 7 Mobile Network* Explains how to use Mobile Network functionality.
- ❖ *Chapter 8 Others* Explains how to use Camera, GPS, NFC and Key Map functionalities.
- ❖ *Chapter 9 Admin Tool* Explains how to use the admin tool.

-
- ✧ *Chapter 10 Whitelist Manager* Explains how to use the whitelist management tool.
 - ✧ *Chapter 11 System Update* Explains how to update the system.
 - ✧ *Chapter 12 APP Development Guide* Describes the APP development environment and the use of non-standard interfaces.
 - ✧ *Chapter 13 Maintenance & Troubleshooting* Provides troubleshooting solutions for issues that might occur when using the MT90.

More Information

For more product and support information, please visit our web site: <http://www.newlandaidc.com>.

Chapter 2 Getting Started

Introduction

This chapter lists the parts and accessories for the MT90 and explains how to install, remove and charge the battery, and power on the MT90 for the first time.

Unpacking

Carefully remove all protective material from the pack and verify that the followings were received:

- ✧ 1 x NLS-MT90 main unit
- ✧ 1 x USB cable
- ✧ 1 x AC adapter for the MT90
- ✧ 1 x Li-polymer battery
- ✧ 1 x Wrist lanyard
- ✧ 1 x Quick start manual

Accessories (Optional)

- ✧ Charging cradle for the MT90
- ✧ 4-slot battery charger
- ✧ Trigger handle
- ✧ RFID handheld reader
- ✧ Long-range barcode reader NLS-EX90
- ✧ Protective sleeve

Getting Started

The MT90

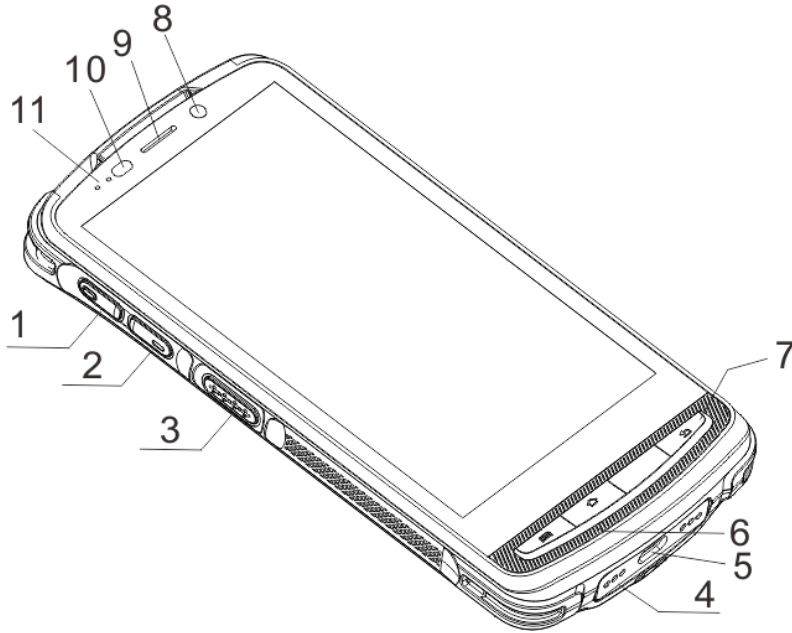

1	Volume+	2	Volume-
3	Left Scan Key	4	Cradle Connector
5	Micro USB Port	6	Microphone
7	Keypad	8	Front Camera (optional)
9	Earpiece	10	Light/Proximity Sensors
11	Red/Blue LEDs		

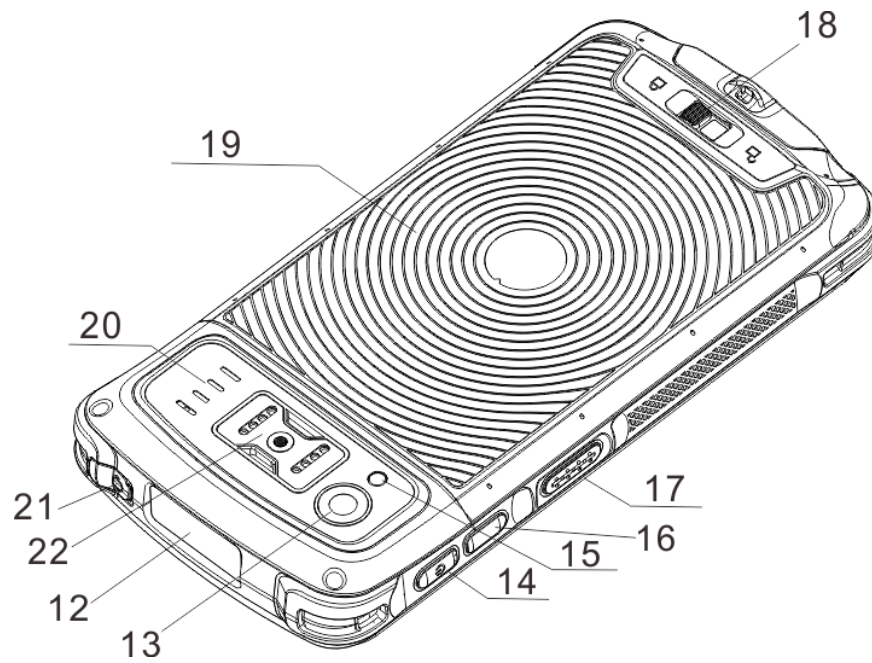

12	Scan Window	13	Rear Camera
14	Power Key	15	Flashlight
16	User-defined Key	17	Right Scan Key
18	Battery Cover Latch	19	NFC Detection Area
20	Speaker	21	Headphone Jack Cover
22	Expansion Port		

USB Charging Cradle

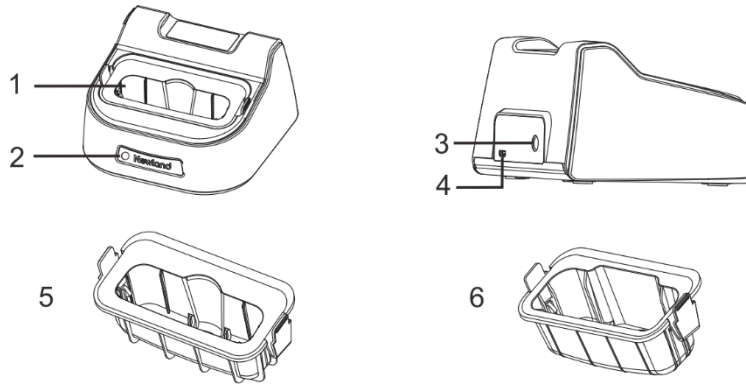

1	Charging Slot	2	Power LED
3	Power Jack	4	USB Port
5	Terminal Holder for MT90 main unit only	6	Terminal Holder for MT90 with rubber boot or pistol grip

Ethernet Charging Cradle

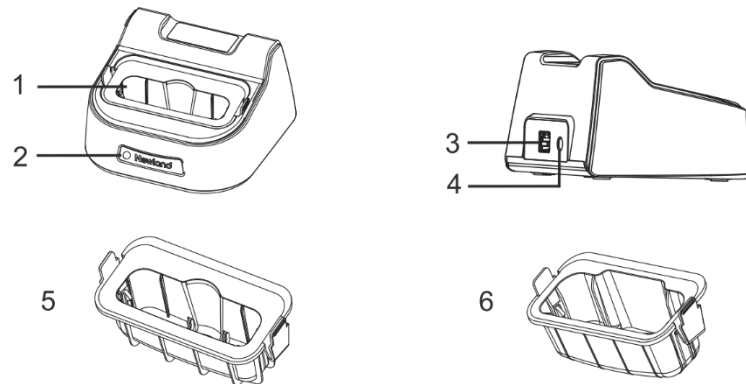

1	Charging Slot	2	Power LED
3	Ethernet Port	4	Power Jack
5	Terminal Holder for MT90 main unit only	6	Terminal Holder for MT90 with rubber boot or pistol grip

Installing the Battery

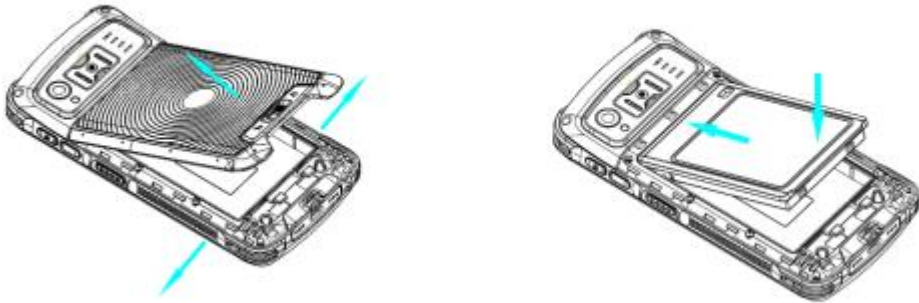

Step 1: Slide the battery cover latch to the unlock position and remove the cover.

Step 2: Insert the battery as indicated into the battery compartment, with its metal contacts facing down and lining up with the metal contacts on the inside of the terminal.

Removing the Battery



Step 1: Hold down the Power key for 5 seconds and then tap "Power off" to turn off the terminal. Slide the battery cover latch to the unlock position and remove the cover.

Step 2: Remove the battery.

Charging the Battery

Connect the MT90 to a power outlet using the included AC adapter or USB cable. When the terminal's battery is less than 5%, it takes about 3 hours to fully charge it (The terminal is shut down or in sleep mode).



Note: Low battery may result in malfunction of the terminal. Before your first use, charge the battery for at least 8 hours.

When charging the MT90 with AC adapter or USB cable, the user is notified the charging statuses by the LEDs on the terminal.

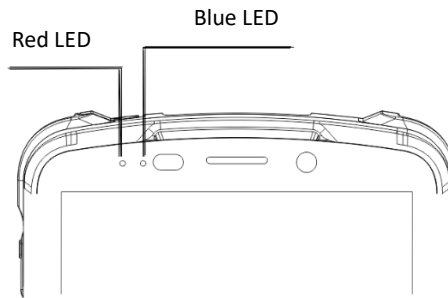

LEDs on the MT90	
Blue LED on	Fully charged
Red LED on	Charging in progress
Red LED flashes constantly	Low-battery alert

Note: If MT90 battery is completely drained, please press the power key to turn it on after 15 minutes of being charged.

Keypad

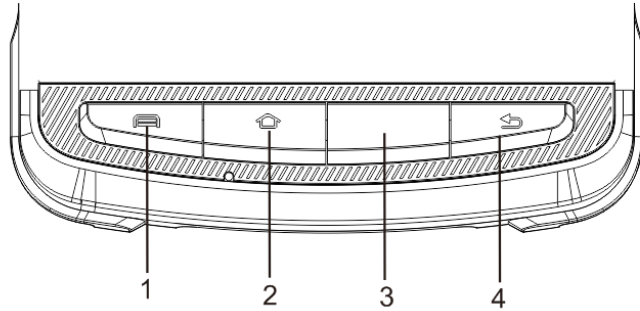

1	Menu Key
---	----------

2	Home Key
---	----------

3	Function Key (Scan Key by default)
---	------------------------------------

4	Return Key
---	------------

The MT90 has 10 keys, with Menu/Home/Function/Return keys on the front panel, Volume+/Volume-/Scan keys on the left side and Power/User-defined/Scan key on the right side.

Menu Key: Press it to display the app(s) most recently used. Tap an app to open it or tap “Clear All” to remove all apps at once.

Home Key: Press it to go to the Home Screen.

Function Key (Scan Key by default): Use it to scan barcodes.

Return Key: Press it to go back to the previous screen.

Note: Except for the Power key, other keys are user programmable.

Communicating with PC

Step 1: Connect the Micro USB port on the MT90 to your computer with the included USB cable.

Step 2: Switch the MT90 on. On the Home screen, swipe from top to bottom with one finger in one smooth motion to open the notification bar as shown below.

Step 3: Tap “Tap for more options”.

Step 4: Select “Transfer files”. Navigate to the “My Computer” section of your computer and look for the newly added drive. Double-click it and you will be connected to the MT90. Then you may handle the files on the terminal through your computer.

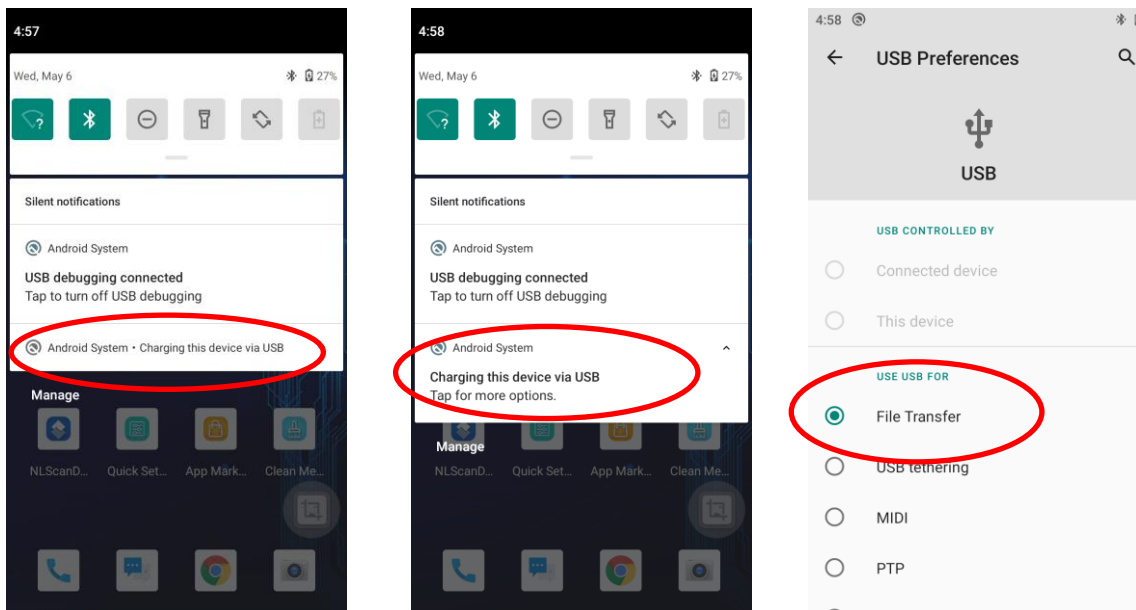

Installing the MicroSD Card/SIM Card

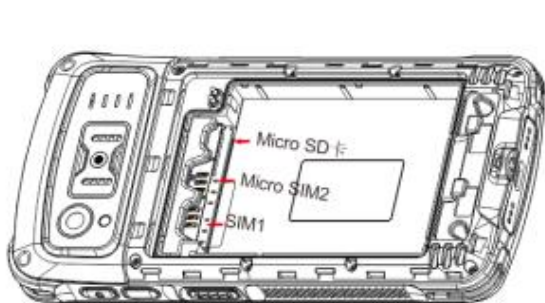

Without SIM/TF Card

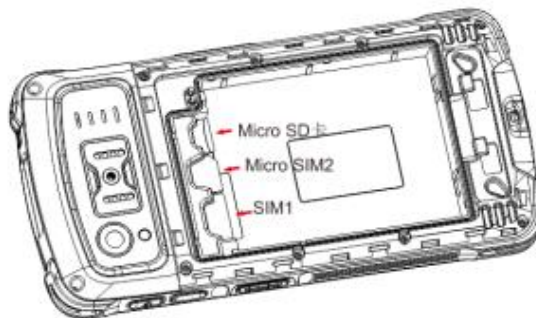

With SIM/TF Card

Step 1: Slide the battery cover latch to the unlock position and remove the cover.

Step 2: Insert the Micro SD card/ Micro SIM card into the corresponding slot, with its metal contacts facing down.

Step 3: Close the cover and slide it upward until it clicks.

Note: There are three kinds of SIM cards in the market:

1. **SIM:** Size 25mm × 15mm × 0.8mm
2. **Micro SIM:** Size 12mm × 15mm × 0.8mm
3. **Nano SIM:** Size 12.3mm × 8.8mm × 0.7mm

MT90 can only support **SIM** and **Micro SIM**.



Chapter 3 Basics

Introduction

This chapter provides the basics of setting and using the MT90.

Switching On/Rebooting/Switching Off the MT90

After installing the SIM card and battery and having the MT90 fully charged, you may switch the terminal on.

Switch the MT90 on: Hold down the Power key on the right side of the terminal until the terminal vibrates. Note that the initialization is going to take some time before the MT90 displays the Home screen.

Reboot the MT90: Hold down the Power key on the right side of the terminal until the window below pops up, then tap “restart”.

Switch the MT90 off: Hold down the Power key on the right side of the terminal until the window below pops up, then tap “Power off”.

Screenshot the MT90: Hold down the Power key until the window below pops up, then tap “Screenshot”.

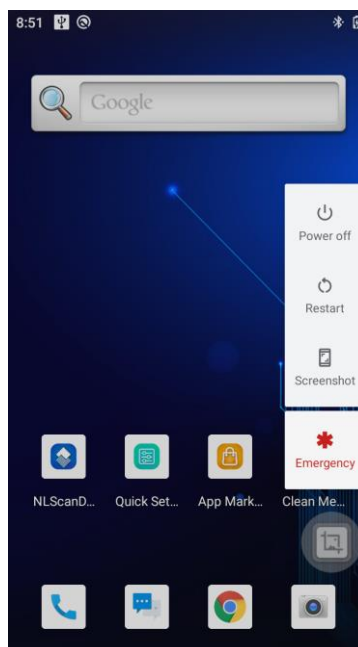

Locking/Unlocking the MT90

Lock the MT90: Briefly press the Power key on the right side of the terminal. If no operation is performed on the MT90 for a preset period of time, the MT90 locks automatically. You can change how long it takes for the MT90 to lock.

Unlock the MT90: Briefly press the Power key on the right side of the terminal. Then swipe home screen from bottom to top with one finger in one smooth motion to open.

Home Screen

View another Home screen: Swipe left or right.

Go to the Home screen: Press the Home key on the front panel of the terminal.

Open an app: Tap the app icon.

View all apps/Open apps list: Swipe Home screen from bottom to top with one finger in one smooth motion to view all the app.













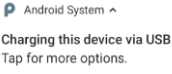
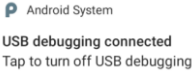

View the App list

Add an app icon to the Home screen: swipe home screen from bottom to top with one finger in one smooth motion to show all app. Tap and hold your desired app until it appears on the Home screen and then drag it into a blank area.

Delete an app icon on the Home screen: Tap and hold your desired app on the Home screen until "X Remove" appears, then drag the app into it. Note that this operation only removes the icon from the Home screen. To remove the app from the MT90, see the **Uninstalling App** section.

Status Icons

The icons in the notification bar at the top of the screen give information about the MT90.

Status Icon	Description	Status Icon	Description
	Wi-Fi connected		Signal strength
	Bluetooth on		Airplane mode on
	USB Connected		USB debugging
	Missed calls		Battery charging in progress
	New Message		Hotspot & tethering
	Positioning		Power Saving Mode
	Don't Disturb Mode		Vibrate on

Installing App

Use one of the following methods to install a new app on the MT90:

1. Download an APK file from online app store and install it.
2. Download software package onto a Micro SD card or PC and copy it to your terminal. Then install it with File Manager.
3. Install a new app using a mobile assistant (such as Baidu Mobile Assistant) installed on the PC.

Uninstalling App

Follow the procedure below to remove an app from the MT90:

Swipe Home screen from bottom to top with one finger in one smooth motion to view all the app. Tap and hold your desired app until "App info" appears, then tap "App info" and uninstall it

*The application that comes with the system cannot be uninstalled.

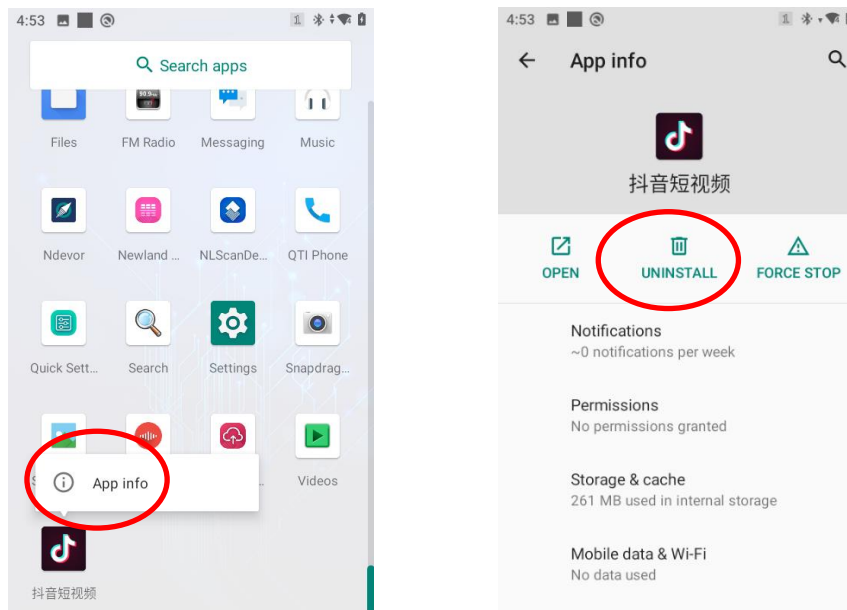

Date & Time

Set the date and time: Tap the app icon  and then “System” -> “Date & time”, and set the date and time on the screen shown below as per your needs.

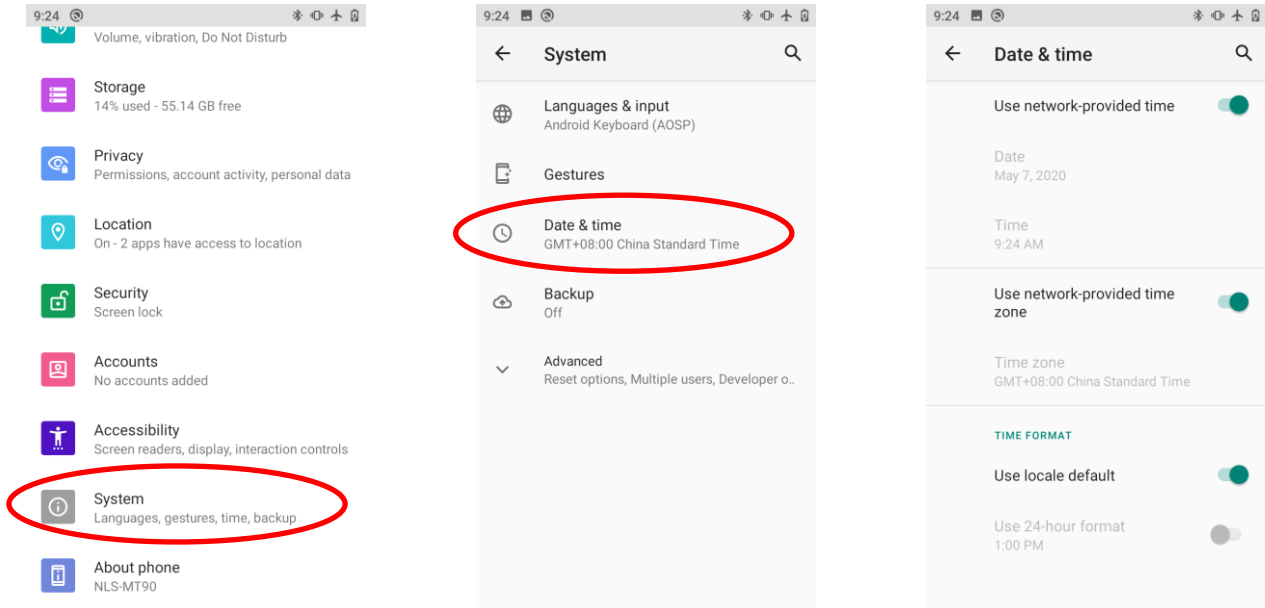

Display

Tap the app icon  and then “Display”, and set the brightness level, night light, wallpaper and other parameters on the screen shown below as per your needs.

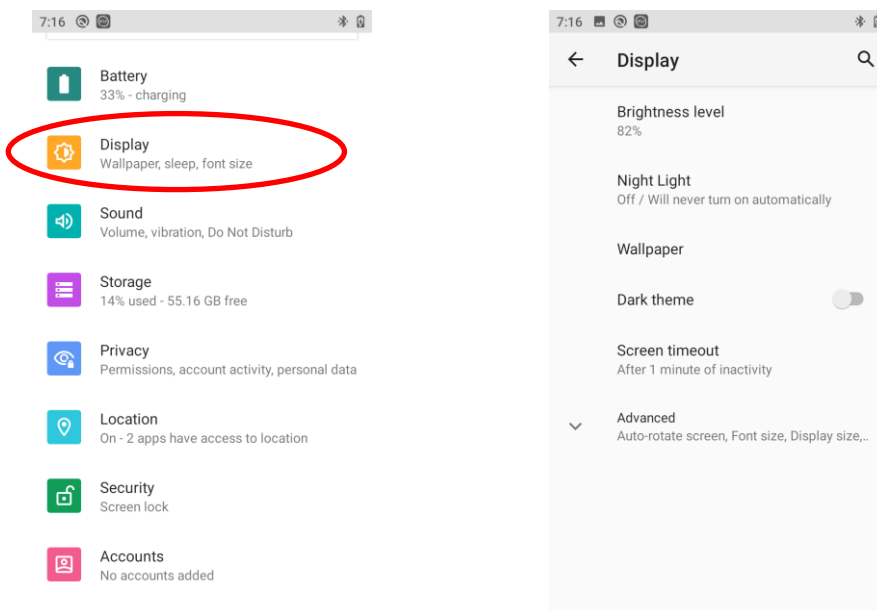

Ringtones

Tap the app icon  -> "Sound". Then set the ringtones and other notification sounds as per your needs.

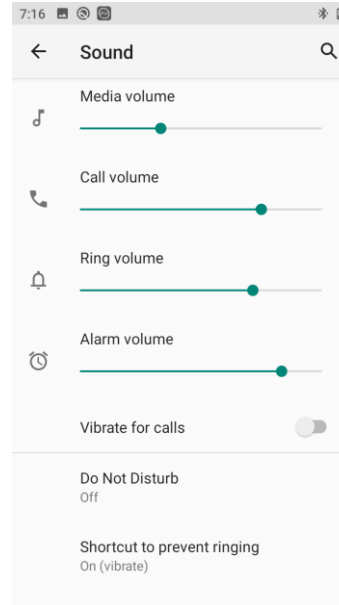
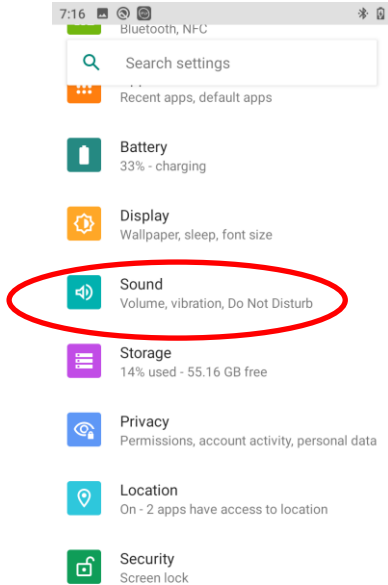



Restoring Factory Settings

Tap the app icon  -> "System" -> "Advanced" -> "Reset options" -> "Erase all data(factory reset)" -> "Erase all data"

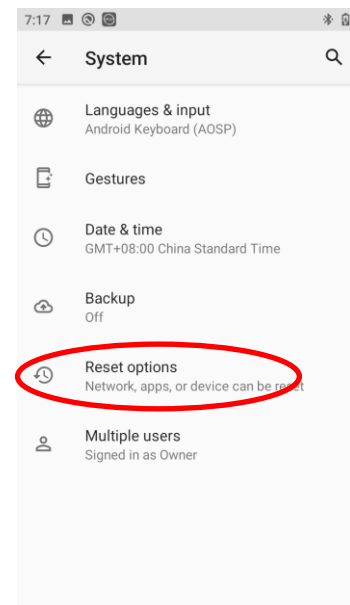
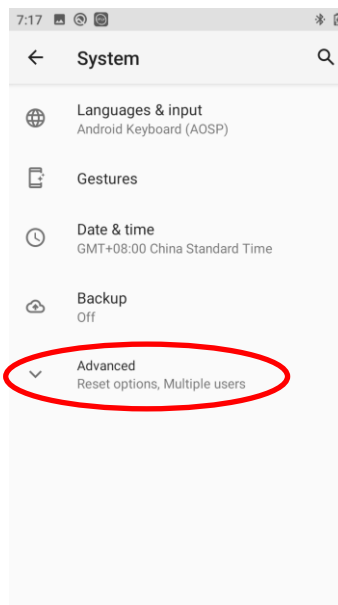
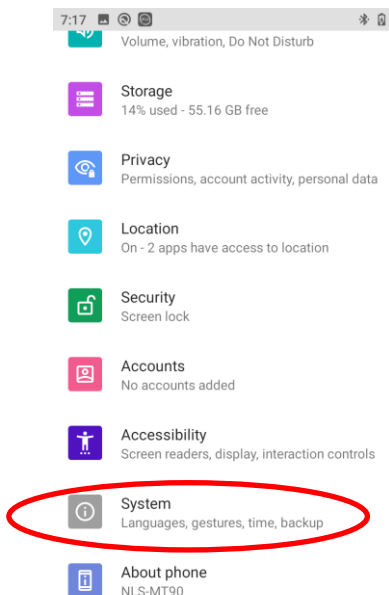
After this operation, the terminal will be reset to factory defaults and all the personal data on the internal storage, such as music and photos, will be deleted.



Note:

1. **Reset WI-FI, mobile & Bluetooth:** Tap the app icon  -> "System" -> "Advanced" -> "Reset options" -> "Reset WI-FI, mobile & Bluetooth" -> "reset settings" -> "reset settings".
2. **Reset app preferences:** Tap the app icon  -> "System" -> "Advanced" -> "Reset options" -> "Reset apps".

Language & Input Method

Tap the app icon  -> "Languages & input". Then set the language and input method as per your needs.

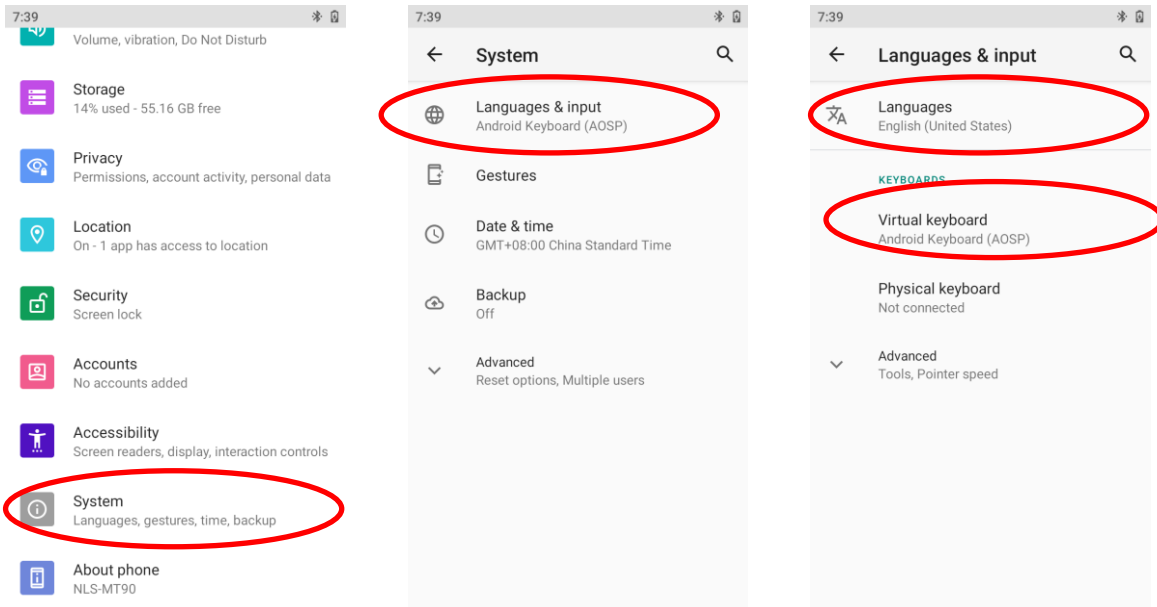

Floating Button Settings

Tapping the floating button can perform tasks such as scanning barcode (**Scan**), turning on/off flashlight (**Flashlight**), taking a screenshot (**Screen snapshot**), turning off screen (**Screen off**), going to the Home screen (**Home**), or switching between level and continue scan mode (**Toggle level and continue scan mode**).

Holding down the floating button  can make it movable.

Show/Hide the floating button: Tap the app icon  -> "Floating" -> select/unselect "Show float box".

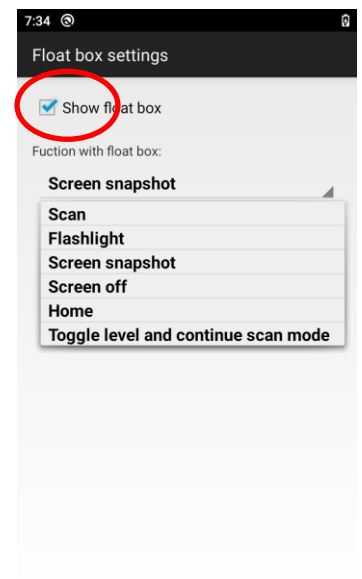
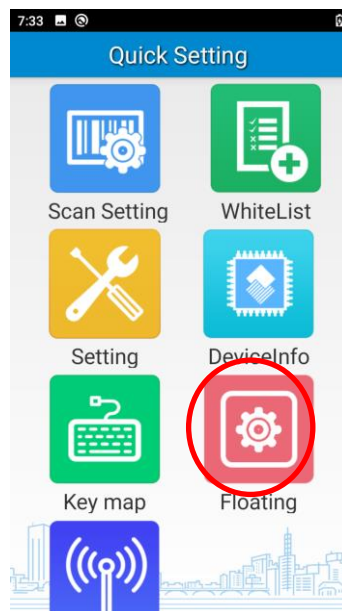
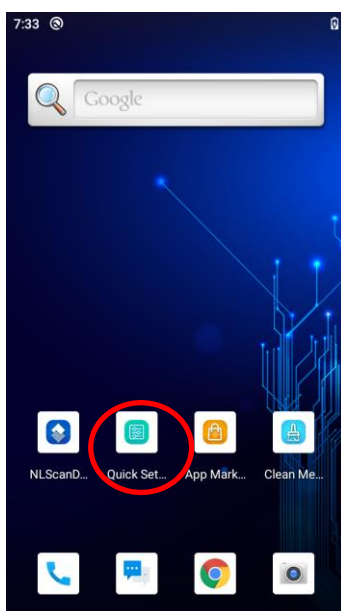

Shortcuts to Apps

Create a shortcut to an app on your Home screen: On the home screen, swipe from bottom to top with one finger in one smooth motion to view all apps. Tap and hold your desired app and then drag it into the Home screen.

Widgets

View all widgets: Tap and hold on a blank area of the Home screen and then tap .

Open a widget: Tap it.

Add a widget icon to the Home screen: Tap and hold the Home screen-> then tap  -> Tap and hold your desired widget and then drag it into the Home screen.

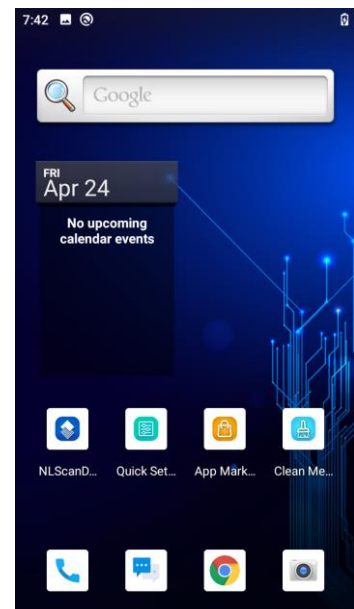
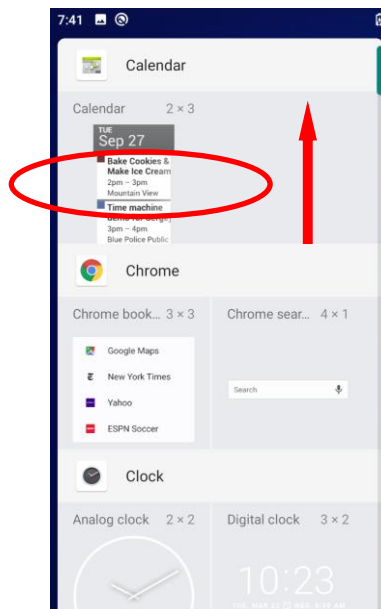
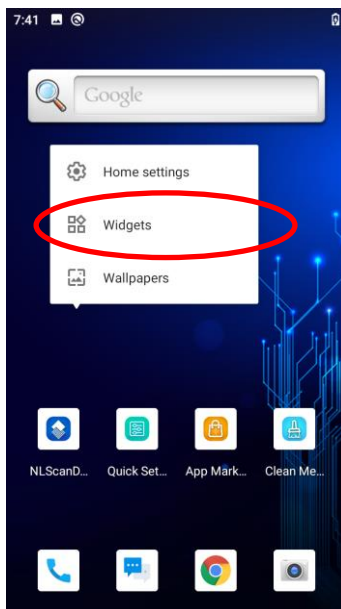

Chapter 4 Scanning Barcodes

Introduction

This chapter includes scanning tips and instructions for setting up the scanner.

Scanning 1D Barcode

Adjust the scan angle or the distance between the MT90 and the target barcode to ensure the length of laser beam is roughly 8mm greater than that of the barcode, as shown below.

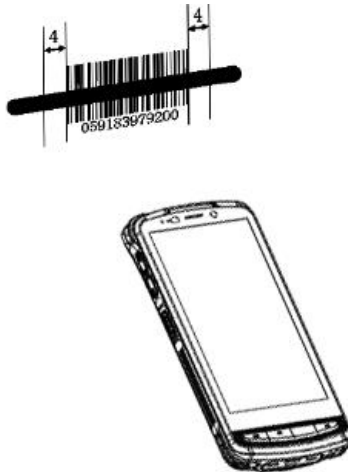

Correct	Wrong
A barcode with a thick black horizontal bar (laser beam) passing over it, correctly aligned horizontally.	A barcode with a thick black horizontal bar (laser beam) passing over it, but the beam is shorter than the barcode.
A barcode with a thick black horizontal bar (laser beam) passing over it, but the beam is longer than the barcode.	A barcode with a thick black vertical bar (laser beam) passing over it, correctly aligned vertically.
A barcode with a thick black diagonal bar (laser beam) passing over it, correctly aligned diagonally.	A barcode with a thick black diagonal bar (laser beam) passing over it, but the beam is shorter than the barcode.

Scanning 2D Barcode

Adjust the scan angle and the distance between the MT90 and the target barcode to make them fall into the following ranges:

1. Point the MT90's focus lamp at the center of the barcode.
2. Move the MT90 until you find the appropriate scan distance.
3. Optimum scan angles:



Skew (α) < 45° (0° preferably)

Pitch (γ) < 45° (5°- 20°preferably)

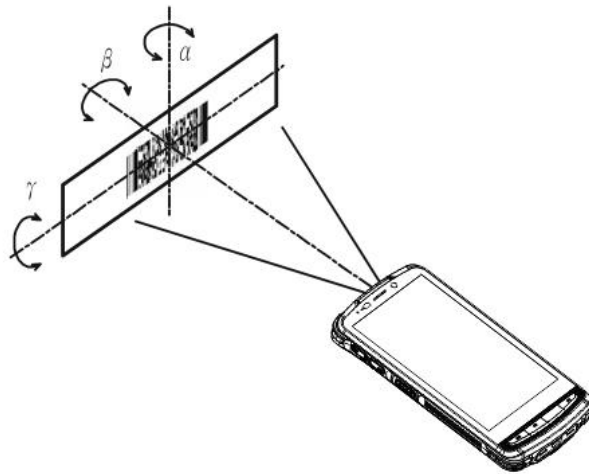
Roll (β) = 0°- 360°



Programming Scanner

Tap the app icon  on the Home screen then . Then configure the scanner parameters as per your actual needs.

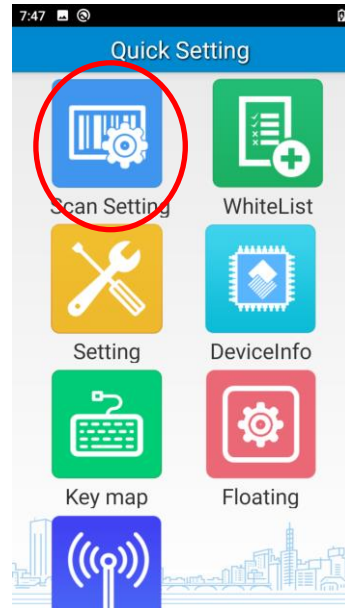
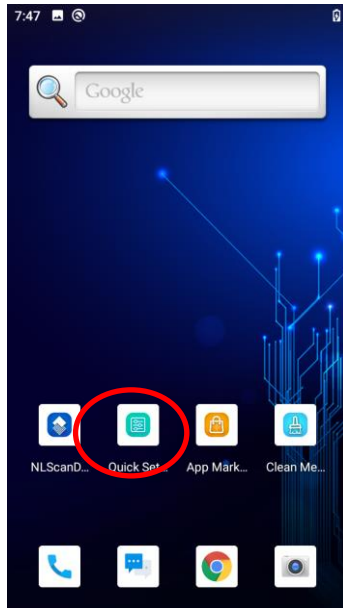

Enable Scan

Check or uncheck the “Enable scan” item to enable or disable the scanning feature of the MT90.

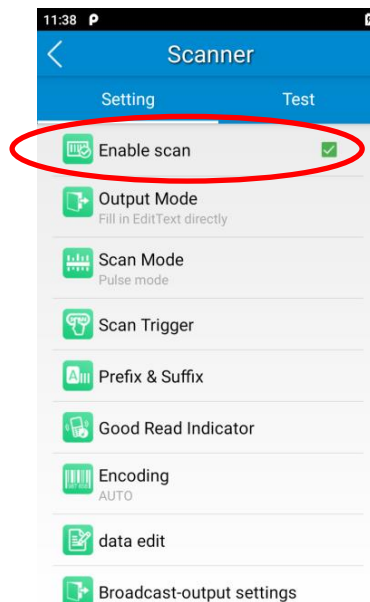

Output Mode

The MT90 provides three output modes: Simulate keystroke, Output via API and Fill in EditText directly.

1. **Simulate keystroke:** Output scanned data to keyboard buffer to simulate keyboard input.

Character interval (ms): A character interval of 0-100 milliseconds may be placed between the transmissions of each character of scanned data.

2. **Output via API:** Application acquires scanned data by receiving system broadcasts.

3. **Fill in EditText directly:** Output scanned data at the current cursor position in EditText.

Overwrite output: Clear the text input box before sending the barcode currently scanned to make sure only the most recently scanned data is present in the text input box. This feature is available only when **Simulate keystroke** or **Fill in EditText directly** is selected.

Output enter-event: Send an Enter Key after each barcode scanned.

Send virtual keyboard function: Make send virtual keyboard function as “action done”, “action search”, “action previous”, action search, etc.

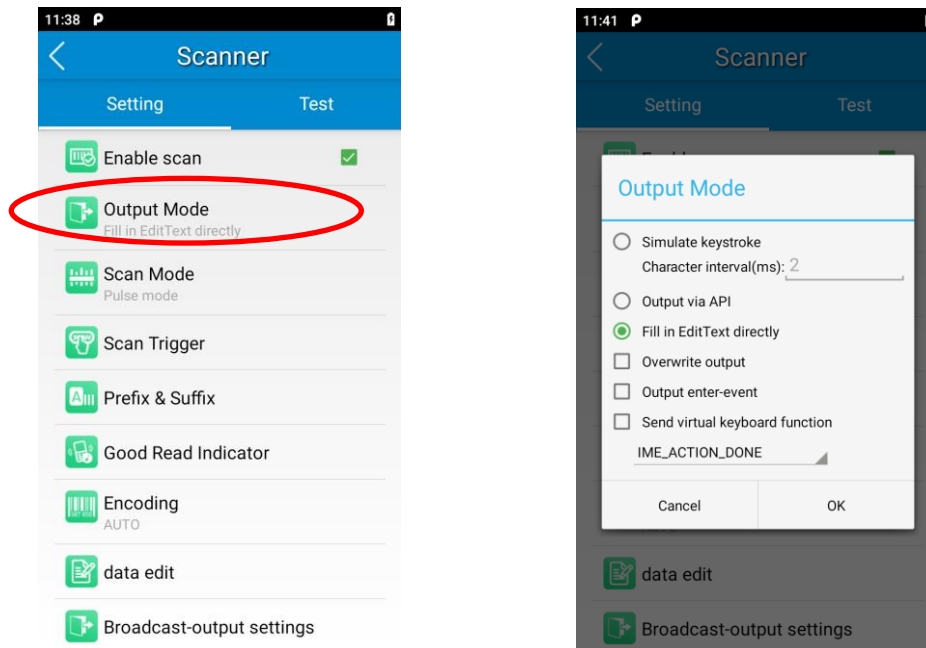

Scan Mode

The MT90 provides the following four scan modes:

1. **Level mode:** Press and hold the scan trigger to start a decode session which continues until the trigger is released.

2. **Continuous mode:** Press the scan trigger to continuously read barcodes. To suspend or resume scan operation, simply press the scan trigger.

Scan interval (ms): This parameter sets the timeout between decode sessions.

3. **Pulse mode:** Press the scan trigger to start a decode session which continues until the decode session timeout expires.

4. **Delay mode (Scan on release key):** Press and hold the scan trigger to aim at barcode then release it to start a decode session which continues until the decode session timeout expires or a barcode is decoded. It is advised to use this scan mode and the **Central Area Decoding** feature to ensure that only the desired barcodes are read if multiple barcodes are placed closely together.

Decode session timeout (ms): This parameter sets the maximum time decode session continues during a scan attempt.

Masked repeat interval (ms): This parameter sets the time interval between two successive reads on the same barcode.

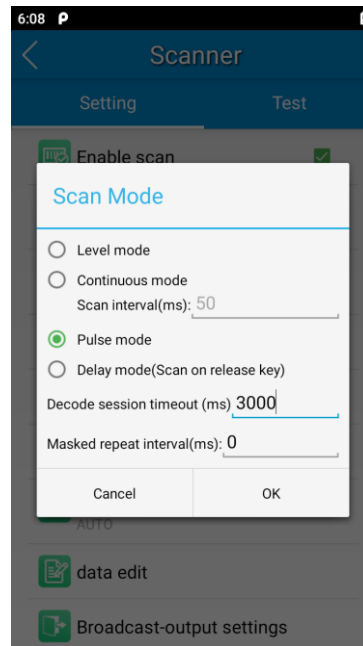
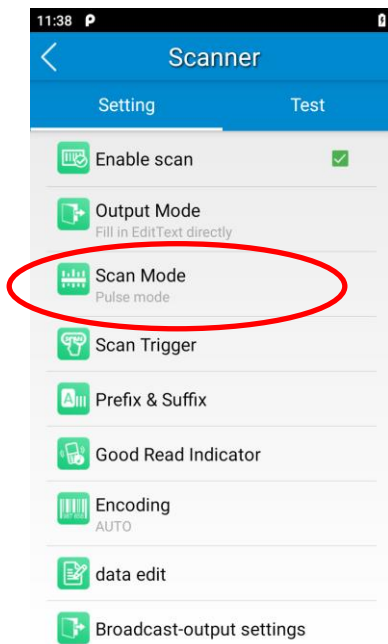

Scan Trigger

The three scan keys on the terminal and the trigger on the pistol grip can all serve as scan trigger. Enable or disable them as per your actual needs.

1. **SCAN key:** Use the Scan key on the front panel of the terminal as scan trigger.
2. **Left/Right SCAN key:** Use the Scan key on the left/right side of the terminal as scan trigger.
3. **Stock SCAN key:** Use the trigger on the pistol grip attached to the terminal as scan trigger.

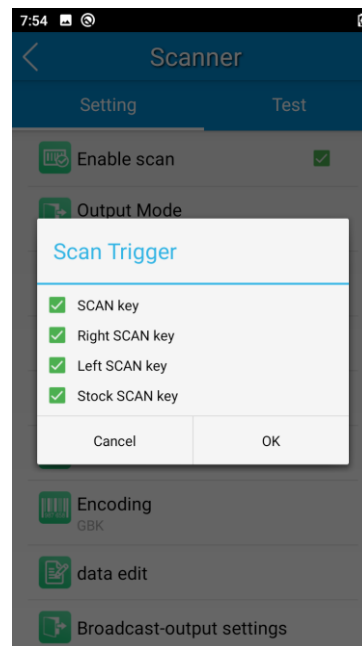
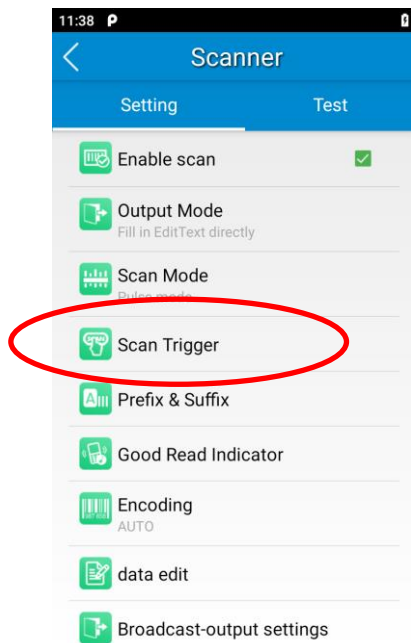

Prefix & Suffix

To set the prefix/suffix, enter the hexadecimal value of a desired prefix/suffix and then tap “OK”. For example, if you want to add a Line Feed character after each barcode, set the suffix to “0A”; if you want to add a Carriage Return character after each barcode, set the suffix to “0D”.

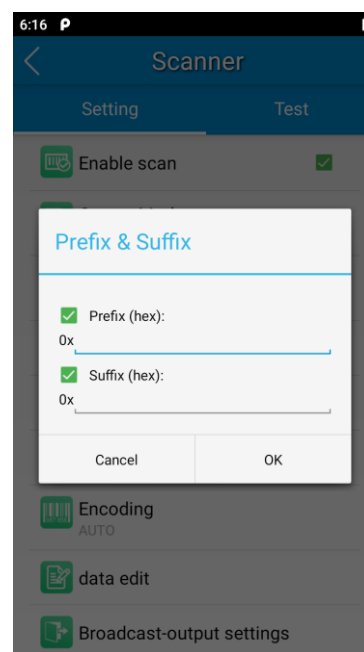
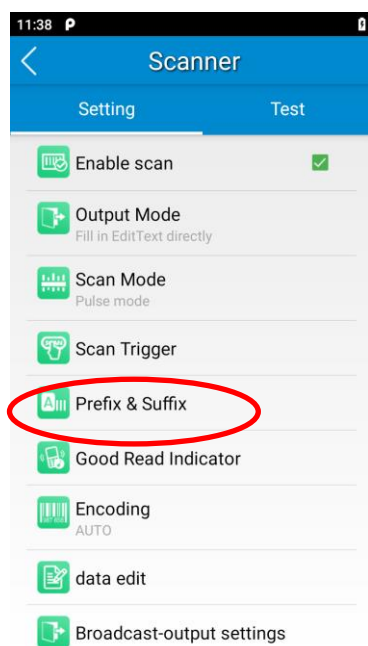

Good Read Indicator

The terminal can use sound/ vibration/ LED to indicate a good read. Choose one or more options as per your actual needs.

1. **Sound:** The MT90 issues a short beep to indicate a good read.
2. **Vibrating:** The MT90 vibrates to indicate a good read.
3. **LED:** The blue LED on the MT90 flashes once to indicate a good read.

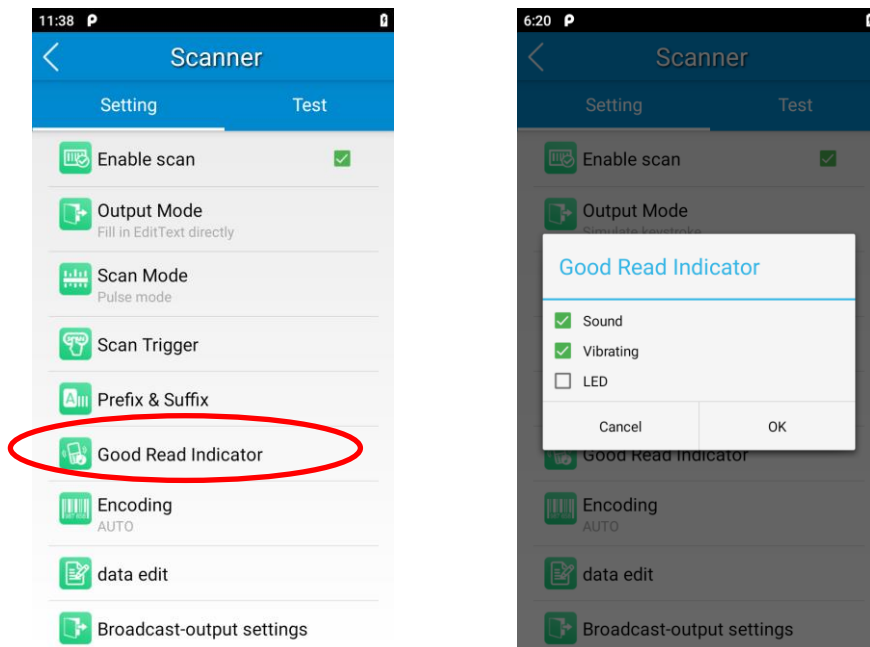

Encoding

Choose a character encoding to interpret barcode data.

1. **AUTO:** The terminal determines automatically if target barcode uses UTF-8, GBK, ISO-8859-1 and windows-1251 encoding. If the terminal produces wrong output, you may need to choose or enter a specific character encoding.
2. **UTF-8:** Dominant Unicode encoding.
3. **GBK:** A character encoding for Chinese characters.
4. **ISO-8859-1:** A common character encoding that covers Western European languages.
5. **windows-1251:** A character encoding designed to cover language that uses the Cyrillic alphabet such as Russian, Bulgarian, Serbian Cyrillic and other languages.
6. **Other:** Enter a different character encoding when UTF-8, GBK, ISO-8859-1 and windows-1251 are not applicable. If the terminal does not support the encoding entered, this setting will fail.

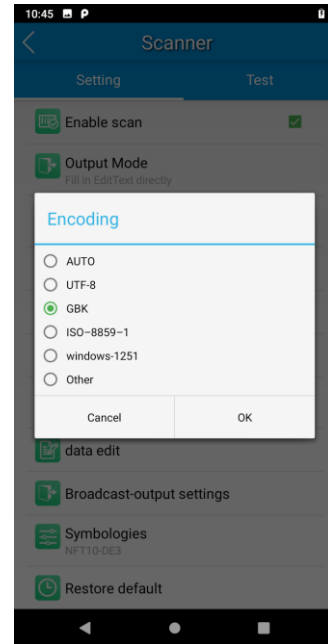
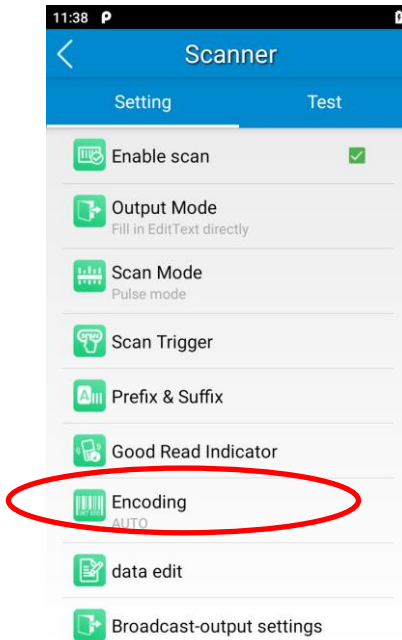

Data Edit

This feature allows you to edit barcode data with a script.

Tap “load script” and then select the desired script file on the terminal, or scan the 2D barcode that contains a script, to load the script. Then select “exec script” and tap “OK”.

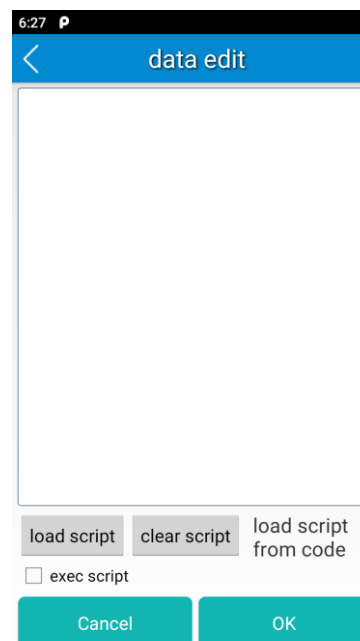
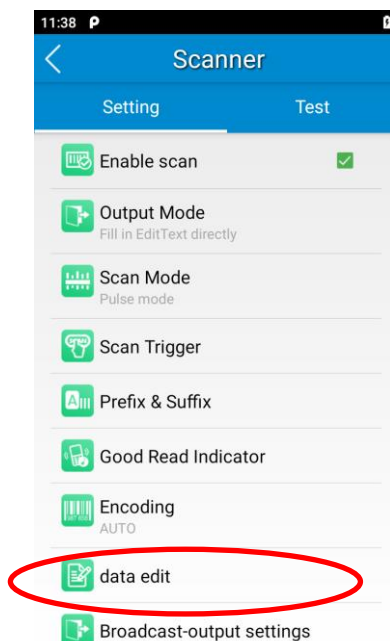

Broadcast-output Settings

When using broadcast as the scan output method, the MT90 will output the scan information with the specified broadcast ACTION and EXTRA.

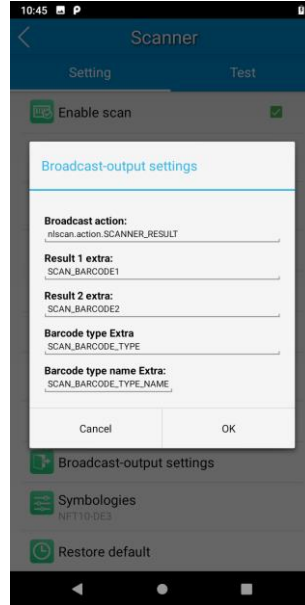
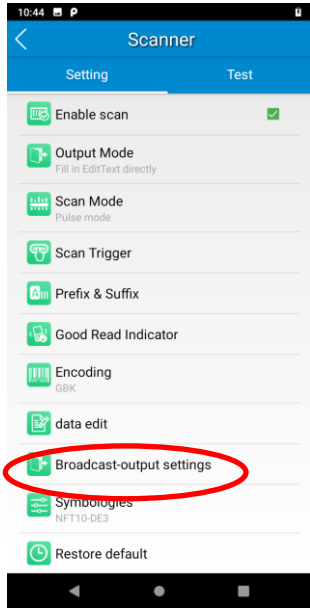

Symbologies

Note that supported symbologies depend on the scan engine integrated in the terminal. Here we will take CM60 for example.

1D code: Enable or disable 1D symbologies and set other barcode parameters.

2D code: Enable or disable 2D symbologies and set other barcode parameters.

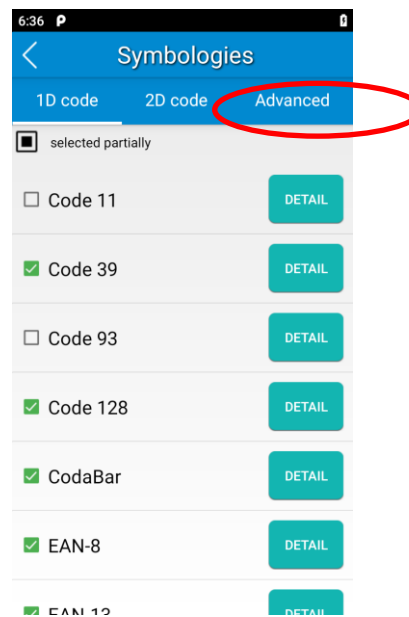
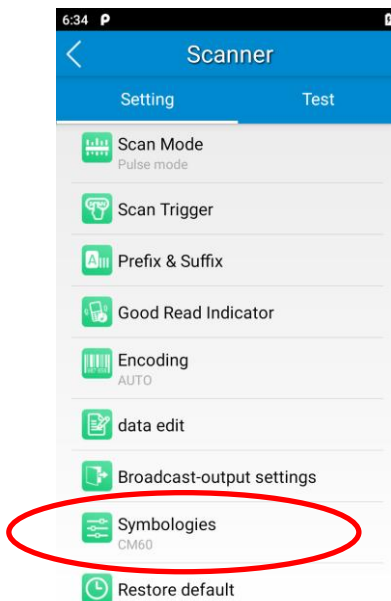

Advanced: The features listed here are designed to improve the scanning performance and energy efficiency of the terminal.

1. **Acuscan decoding:** When selected, the terminal only decodes the barcode aimed squarely by the aiming pattern. It is advised to select it to ensure that only the desired barcodes are read if multiple barcodes are placed closely together.

2. **Other:** Tap **DETAIL** to access the following parameter settings.

Noise reduction: This feature is designed to reduce noise in images produced by the terminal. However, the terminal shows a slight decrease in scanning speed when using this feature. It is recommended to enable it only when necessary.

Power plan: Two options are provided.

Power saving: The terminal's built-in scanner turns off automatically after 3 seconds of inactivity.

High-performance: The terminal's built-in scanner turns off automatically after 15 seconds of inactivity.

OCR Enable: Select this check box when reading passports (compliant with ICAODoc9303 standards, TD1/TD2/TD3 supported).

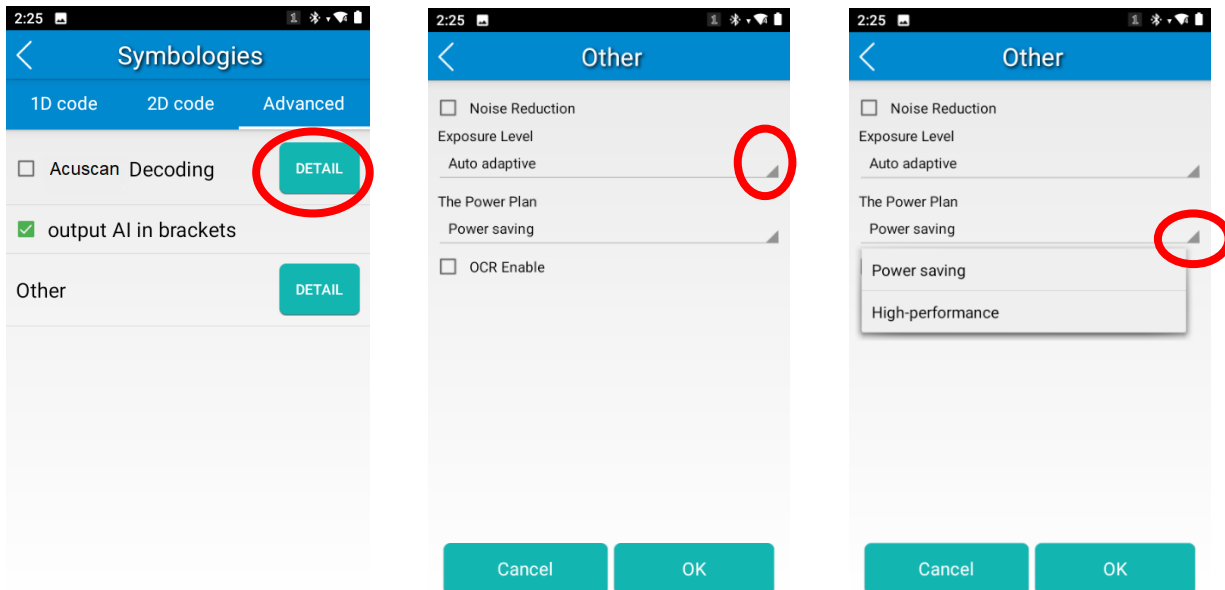

Chapter 5 Bluetooth

This chapter describes how to connect the MT90 to another Bluetooth device.

You can set up a Bluetooth connection between the MT90 and other Bluetooth devices, such as PC, mobile phone. Note that Bluetooth connection works better if there are no obstacles between them.

Before you can use a Bluetooth device with the MT90, you must first pair them.

1. Make the Bluetooth device visible to the MT90.
2. Tap the app icon  then “Connected devices” -> “Connection preferences” -> “Bluetooth”, and turn Bluetooth on to search for available Bluetooth devices.
3. Select the device from the search results to pair.
4. If prompted, input the pairing code and then tap “OK”; or if the pairing code is given automatically, then tap “PAIR”.

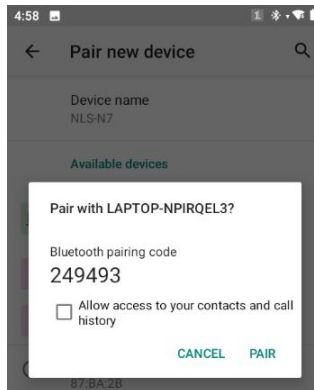
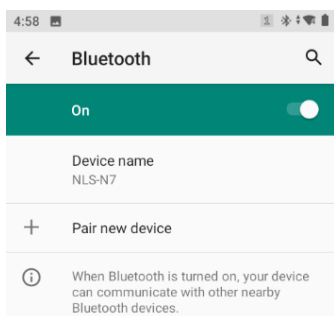

Unpair/rename a paired Bluetooth device: To rename the paired Bluetooth device, tap  next to the device name -> then

tap  to edit its name manually-> tap “RENAME”. To unpair it, tap “FORGET”.

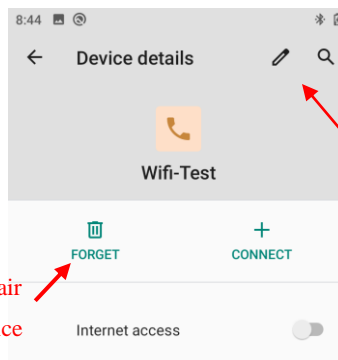
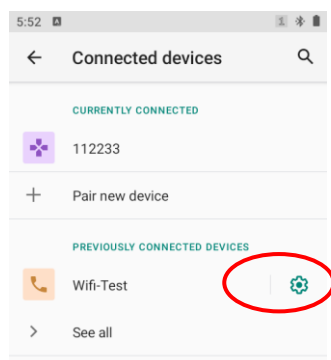

Rename the device name

Unpair Device

Chapter 6 Wi-Fi

Introduction

This chapter describes how to connect the MT90 to a Wi-Fi network.

Join a Wi-Fi Network

1. Tap the app icon  then "Network & Internet" -> "Wi-Fi", and turn Wi-Fi on to find available Wi-Fi networks. If Wi-Fi is already ON, then the terminal will automatically scan for available networks.
2. Tap a network and then enter the password.
3. Tap "CONNECT".

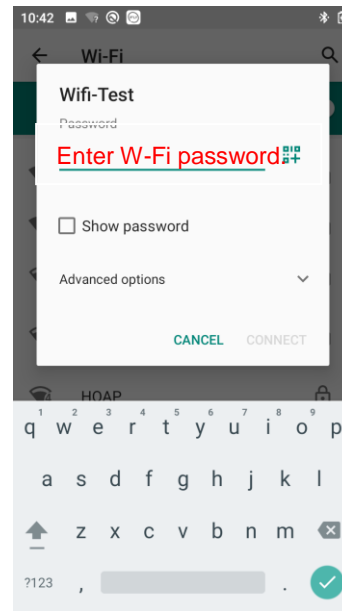
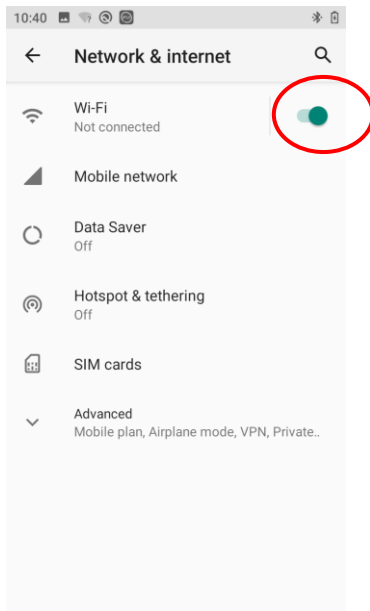
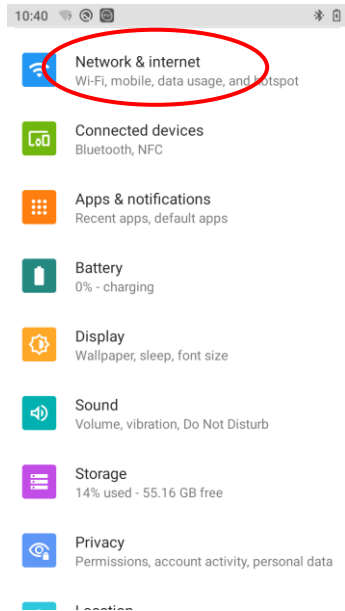

Scanning barcode to connect to the WI-FI: When the WI-FI is shared via a QR Code, Tap  to scan Wi-Fi QR Code, and quickly connect to the Wi-Fi without entering the password.

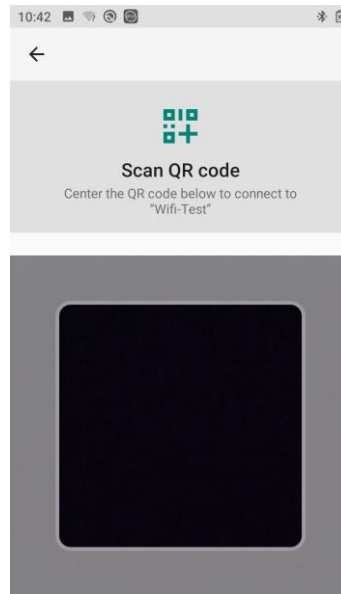
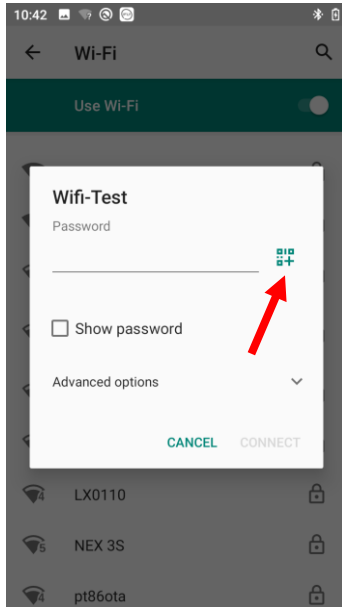

WI-FI Settings

To set the “Metered”, “Proxy”, or “IP setting”, follow the first two steps of joining a Wi-Fi network, tap “Advanced options”, then select the desired option.

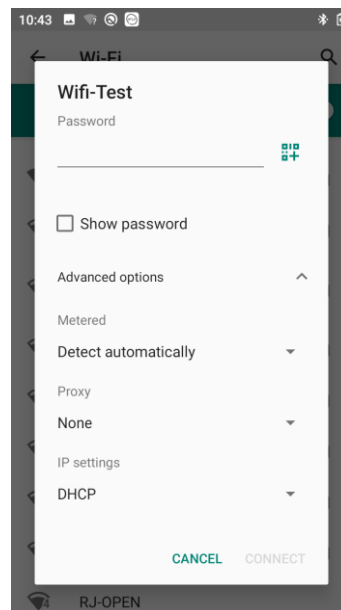
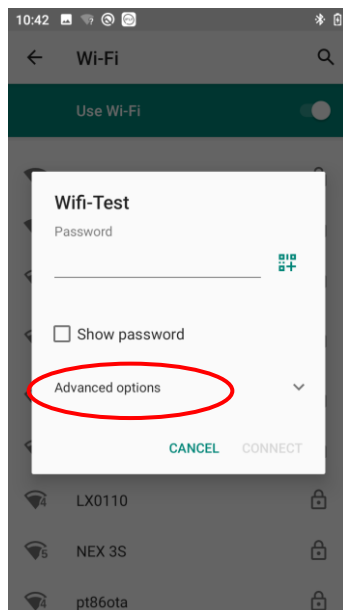

Metered

“Metered” can help us better understand the Wi-Fi network data usage of MT90.

1. **Detect automatically:** Set a Wi-Fi connection as metered or unmetered automatically.
2. **Treat as metered:** Set the Wi-Fi connection to a limited data plan. You can set your connection as metered to avoid additional charges.
3. **Treat as unmetered:** Set the Wi-Fi connection to unlimited data access.

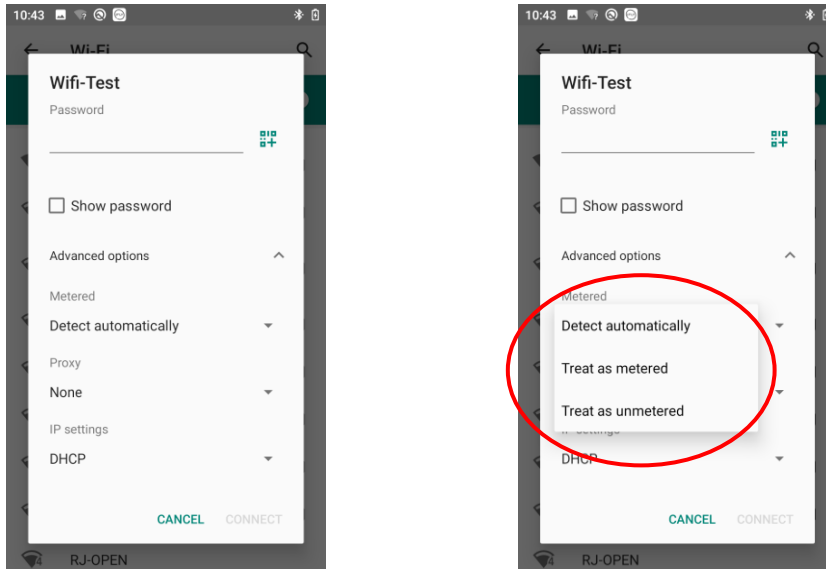

Proxy

The MT90 Provides three types of Proxy: “None”, “Manual”, “Proxy Auto-Config”. To use the proxy function, you need a proxy server first. The address and port of the proxy server should be consulted with the proxy service provider.

With the “proxy” setting, you can change from **direct access** to **transit through a proxy server to access the network**. Through the network strategy of the proxy server, the firewall can enhance the privacy and security of the network.

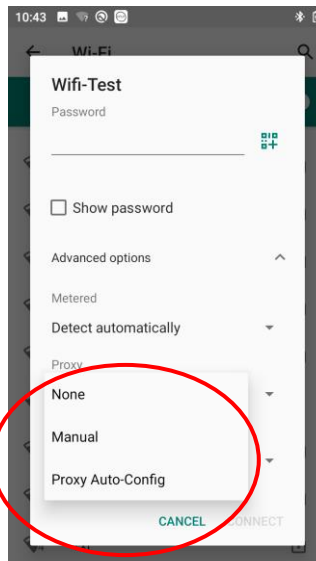

- 1) **None:** No proxy.
- 2) **Manual:** Manually enter proxy server settings.

Following parameters are needed to be filled:
 - a. Proxy hostname
 - b. Proxy port
 - c. The bypass proxy for: Such as local addresses, LAN addresses.
- 3) **Proxy Auto-Config:** Automatically detect the appropriate settings for your network

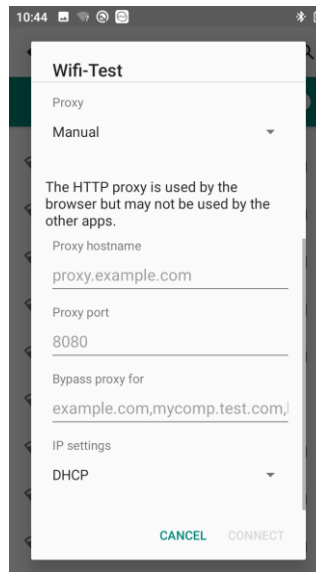

IP Settings

1. Select "DHCP" to automatically obtain an IP address from the router through the DHCP service. The DHCP service should be turned on in the router, otherwise the IP address cannot be obtained.

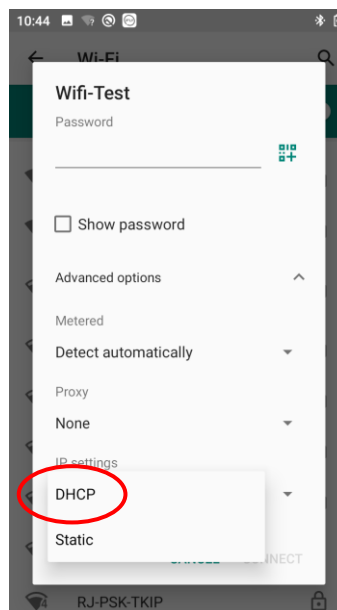

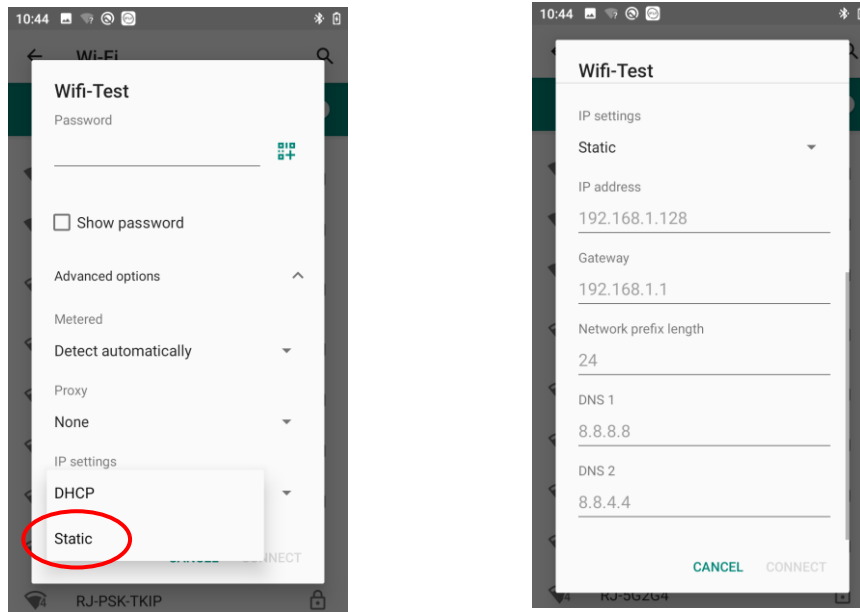

2. Select "Static" to customize the IP address. This will help to avoid the network failure caused by the duplication of the IP address in the LAN or the disable of the DHCP service in the router etc.

Note: To manually set a static IP address, you need to set it according to the range of IP addresses set in the router.



Add Network

Tap the app icon  then "Network & Internet" -> "Wi-Fi" -> "Add Network". There are two methods to add network:

1. Method One: Tap  to add a network by scanning a QR code.

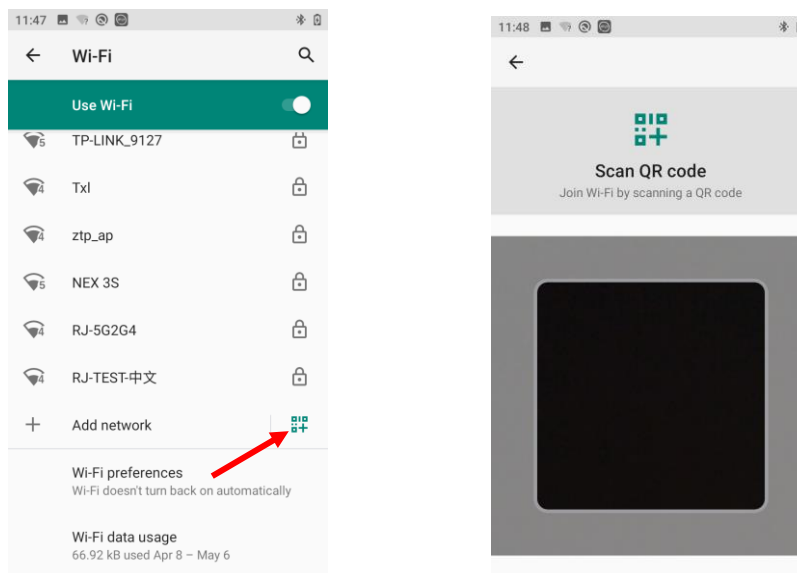

2. Method Two: Manually add network

Step 1: Tap  and fill in the network name you want to add.

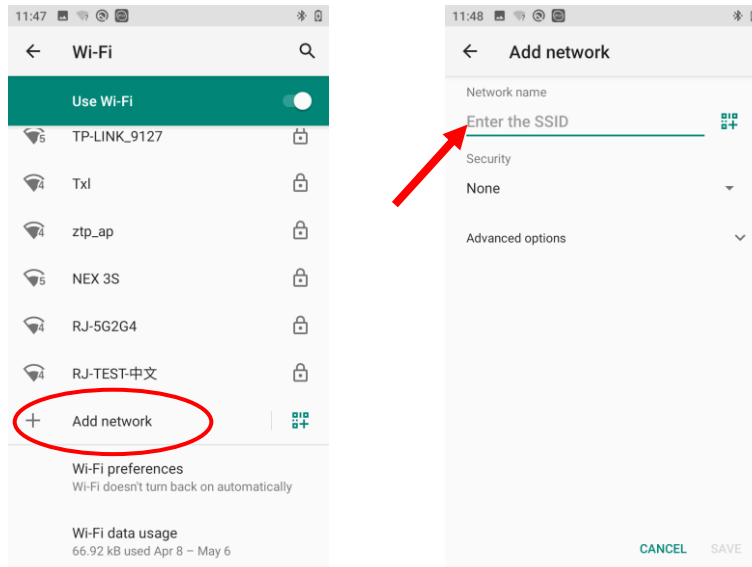

Step 2: Select the corresponding security option according to the encryption type of the router.

Supported security types: Enhanced Open, WEP, WPA/WPA2-Personal, WPA3-Personal, WPA/WPA2/WPA3-Enterprise, WPA3-Enterprise 192-bit.

Step 3: Enter the password and complete the other parameter per the actual network configuration.

Then click "Save" to complete the Wi-Fi addition.

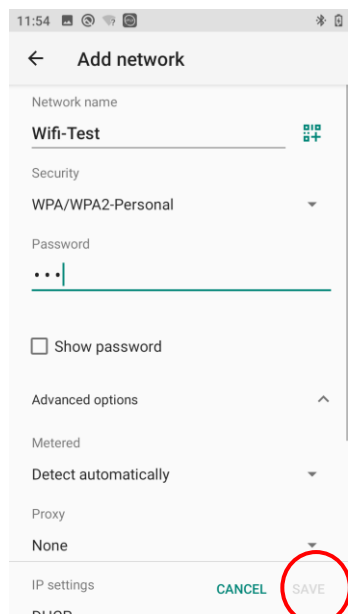

Note:

- 1. The settings for advanced options (“Metered”, “Proxy”, and “IP Settings”) can refer to previous pages.
- 2. **Hidden network:** Some networks hide the SSID during configuration, so they cannot be connected during WLAN search or reconnection. To connect to the hidden SSID network, you should enable the “Hidden network” option.

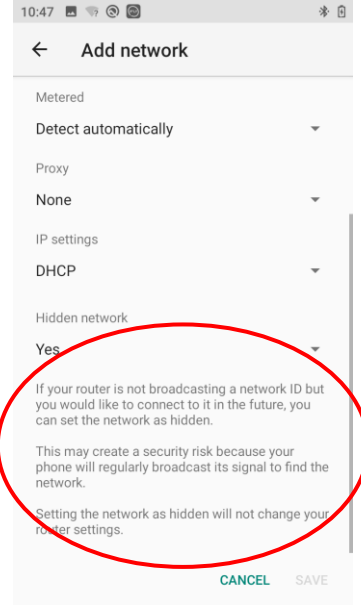
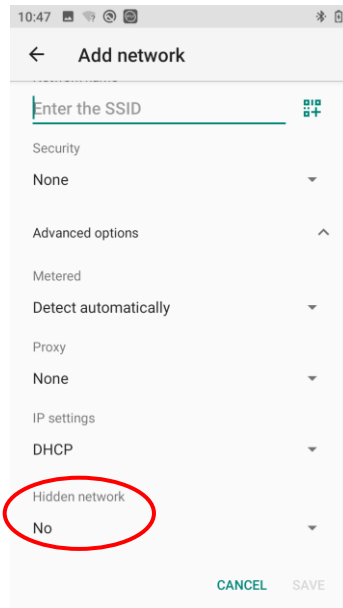

Wi-Fi Preferences

Tap the app icon  then “Network & Internet” -> “Wi-Fi” -> “Wi-Fi preference” Then you can set WLAN Band, WLAN Advanced Mode, and Advanced parameters per actual need.

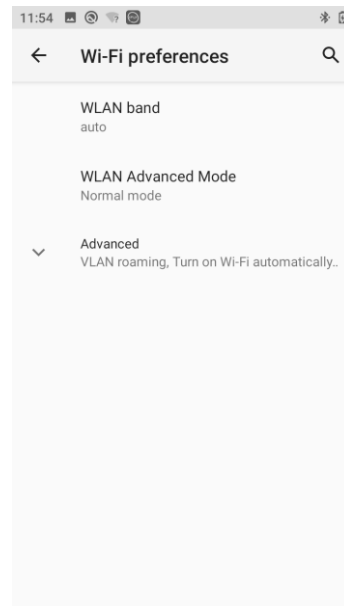
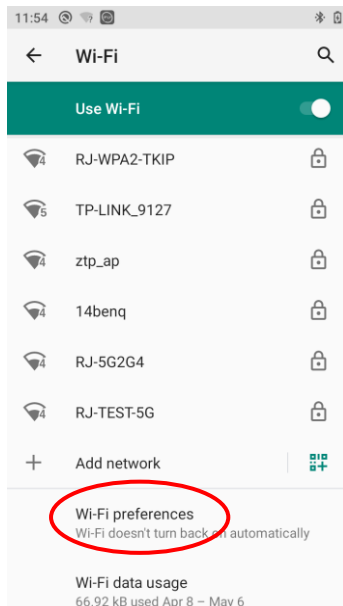

WLAN Band

- a) **Auto:** The WLAN will automatically select 2.4GHz band and 5GHz band.
- b) **Only 2.4G Hz Band:** WLAN will only use the 2.4 GHz band.
- c) **Only 5G Hz Band:** WLAN will only use the 5 GHz band.

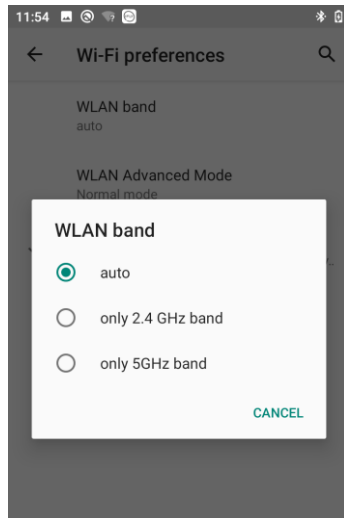

WLAN Advanced Mode:

- a) **“Normal Mode”:** The default setting is the normal mode.
- b) **“Performance Mode”:** You can choose the performance mode (similar to turn off the Battery Saver mode) when you feel that the network roaming or reconnection is slow.

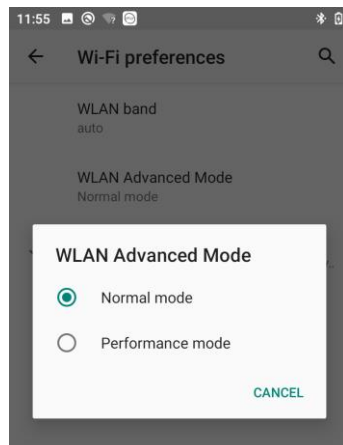

Advanced Setting

- a) **“VLAN roaming”**: When a network has different VLANs, it means that there are different network bands. If roaming is not available in this network environment, you need to enable the “VLAN roaming”.
- b) **“Turn on Wi-Fi automatically”**: Wi-Fi will automatically connect to a saved high-quality network.
Note: To enable this function, you need to turn on the WLAN first.
- c) **“Open Network Notification”**: Notify when a high-quality public network is available.

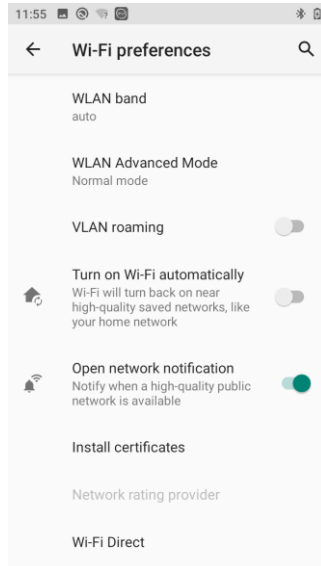

Saved Networks

Tap the app icon  then “Network & Internet” -> “Wi-Fi” -> “Saved networks”, then you can view the networks saved, or set configurations like clear, connect, and share the network per your needs.

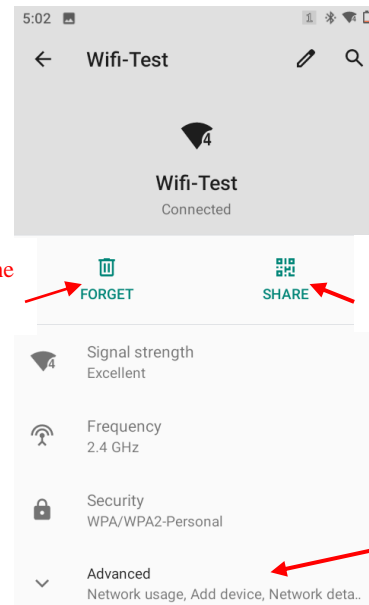
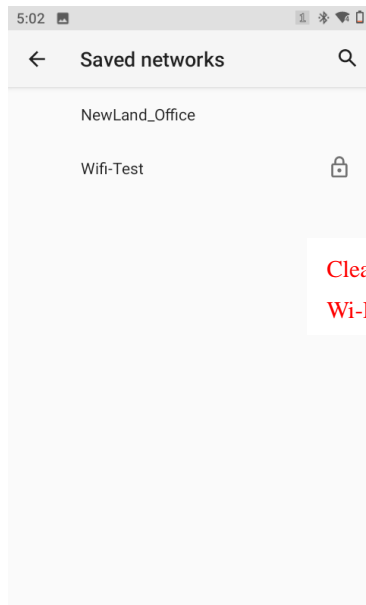
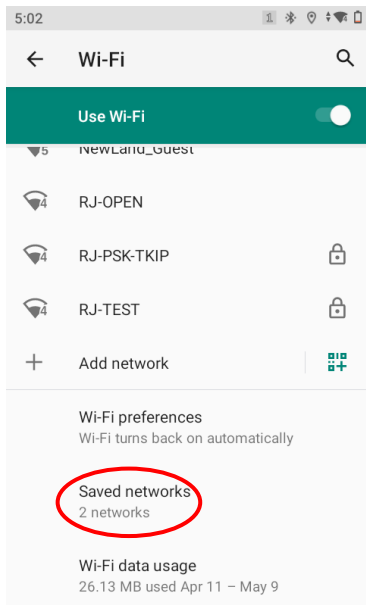

Clear the Wi-Fi

FORGET

SHARE

Share Wi-Fi via QR Code

Tap to add device or review network details.

Wi-Fi Data Usage

Tap the app icon  then “Network & Internet” -> “Wi-Fi” -> “Wi-Fi data usage”, and then you can review the Wi-Fi data usage, including **carrier data accounting** and **APP data usage**.

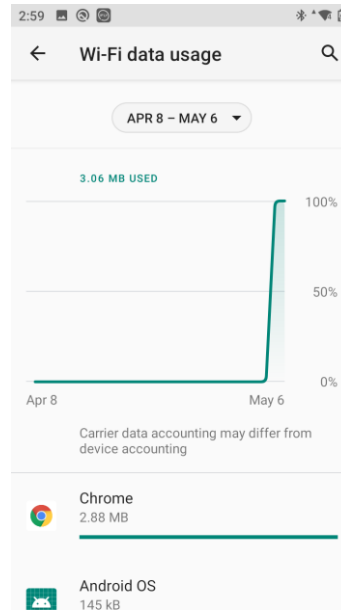
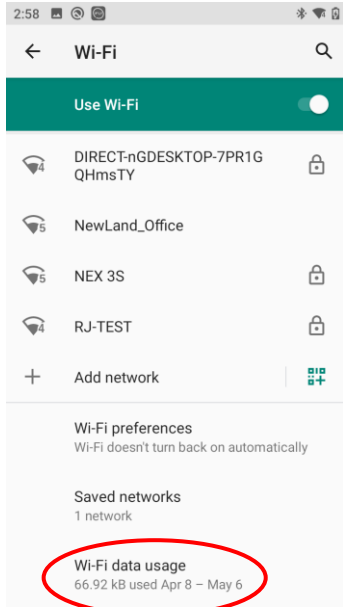

Chapter 7 Mobile Network

Introduction

The MT90 can also use 4G network to connect to the internet. To establish 4G connection, you must have a SIM card installed in your MT90. The MT90 can support both micro sim and sim, and dual cards can be installed at the same time.

This terminal can support 4G/3G/2G network provided by Telecom, Unicom or Mobile

Mobile Network Settings

If no Wi-Fi networks are available, or if you have turned Wi-Fi off, then the MT90 connects to the Internet via your cellular data network when available.

Turn on cellular network:

1. Swipe from top to bottom on the home screen and it will display the drop-down mean, Find  and tap it to turn Cellular data on.
2. Or Go to Settings-> "Network & Internet" -> "Mobile network" -> turn on "Mobile data"

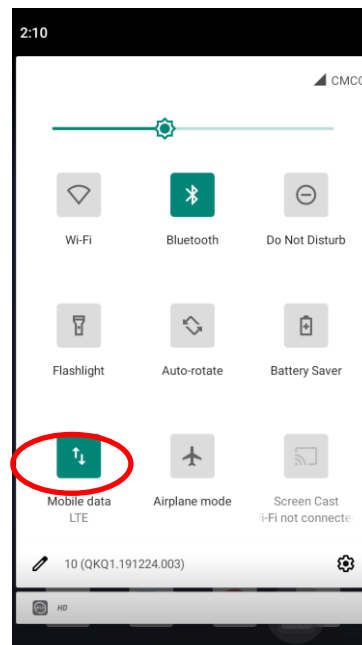
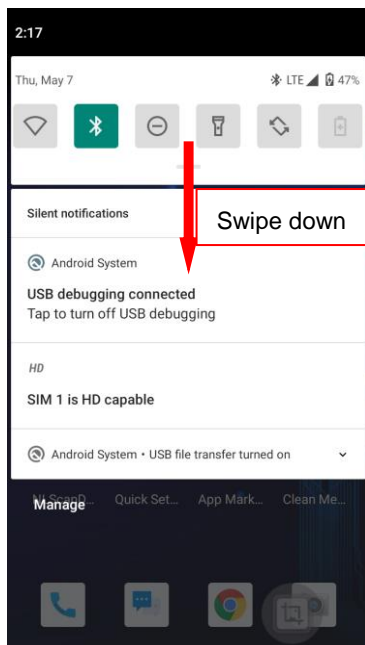

Option Two:

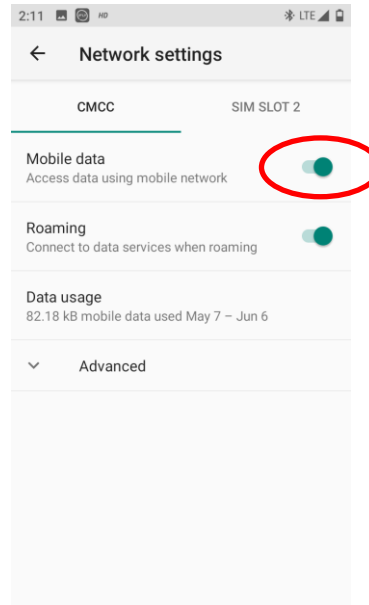
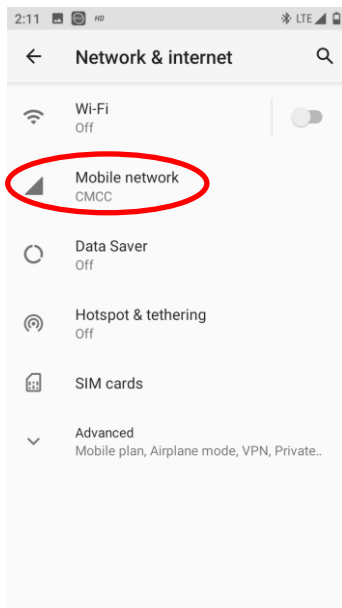

APN Settings

If you cannot connect to the internet when using your terminal's cellular data, you may need to change your APN settings on the MT90 to fix it:

1. Go to Settings-> "Network & Internet" -> "Mobile network" -> "Advanced" -> "Access Point Names".

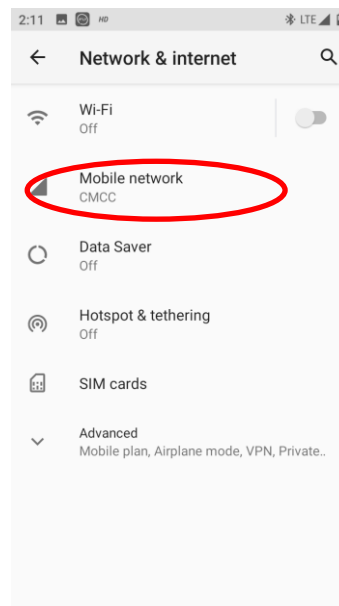
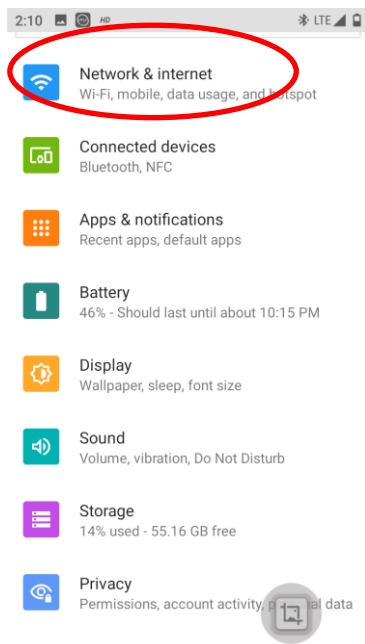

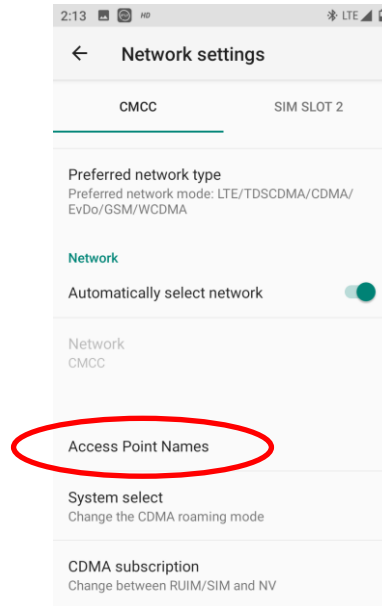
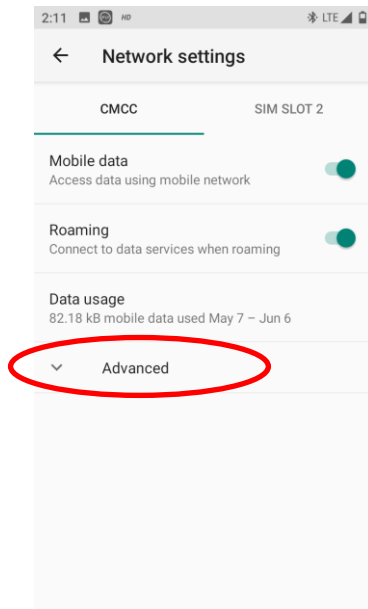

2. Tap **+** in the top right corner of the screen or tap the carrier of your SIM card on the screen. Then manually enter the APN settings. You can contact your carrier or visit their website to get the correct APN settings, or check the APN settings on a mobile device that can access the internet using the SIM card.

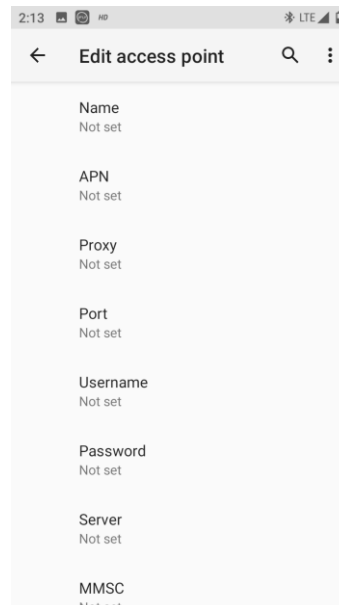
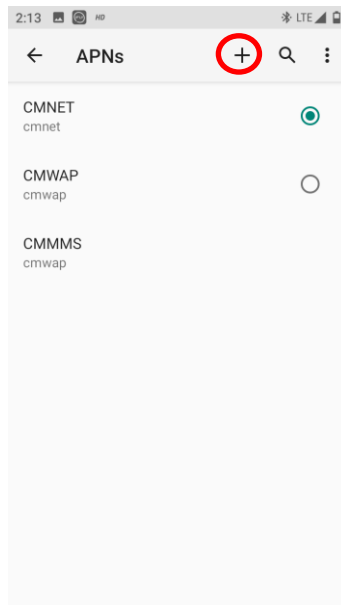

3. Press the Return key on the MT90 to go back to the previous screen and then select the APN you just added.

Chapter 8 Others

Camera

Tap the app icon  to launch the Camera app.

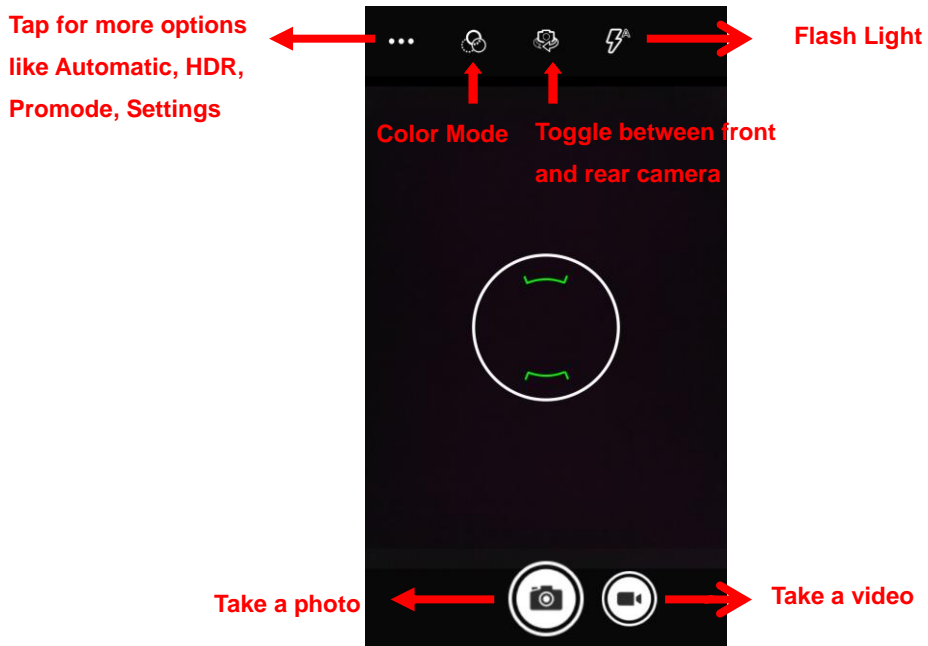

: Tap it to reveal the parameters such as GPS location, exposure level, and white balance and set those parameters as per your needs



: Tap it to take a photo.



: Tap it to take a video.

You can also download a camera app from the Internet or develop an app for the camera feature.

GPS

Tap the app icon  then “Location”, and then turn Location on.

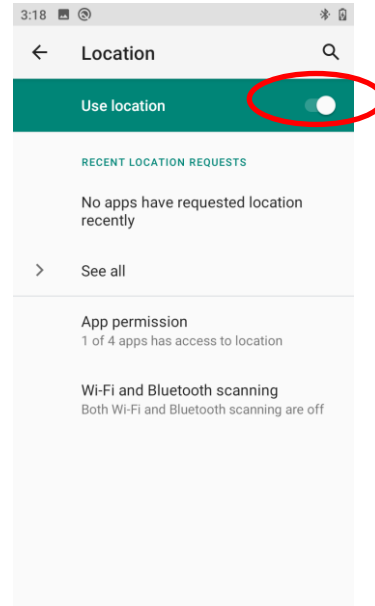
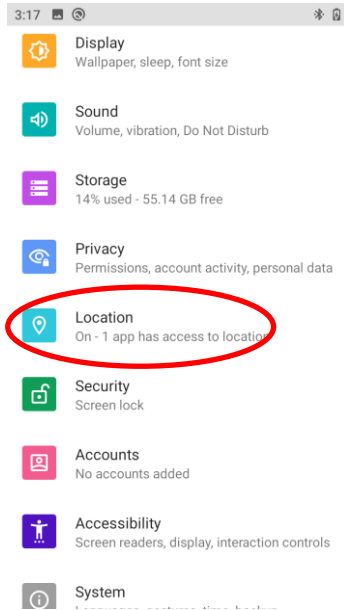

Turn on the “Wi-Fi and Bluetooth scanning” can help to improve location-based features and services, but it will also increase power consumption.

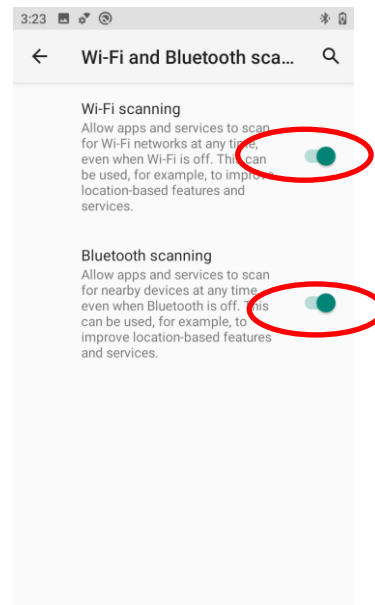
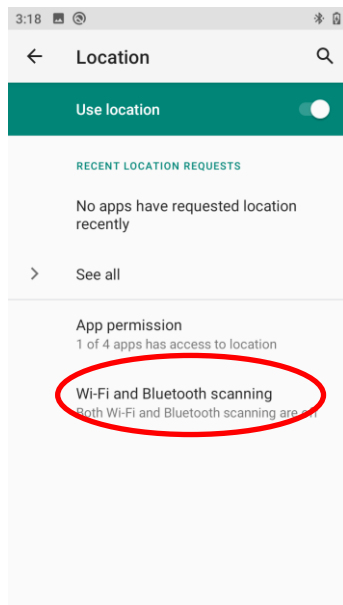

NFC

To enable the NFC feature, tap the app icon  -> "Connected devices" -> "Connection preferences" -> "NFC", and then turn on NFC.

Then you can install an NFC writer on the MT90 to read and write NFC tags.

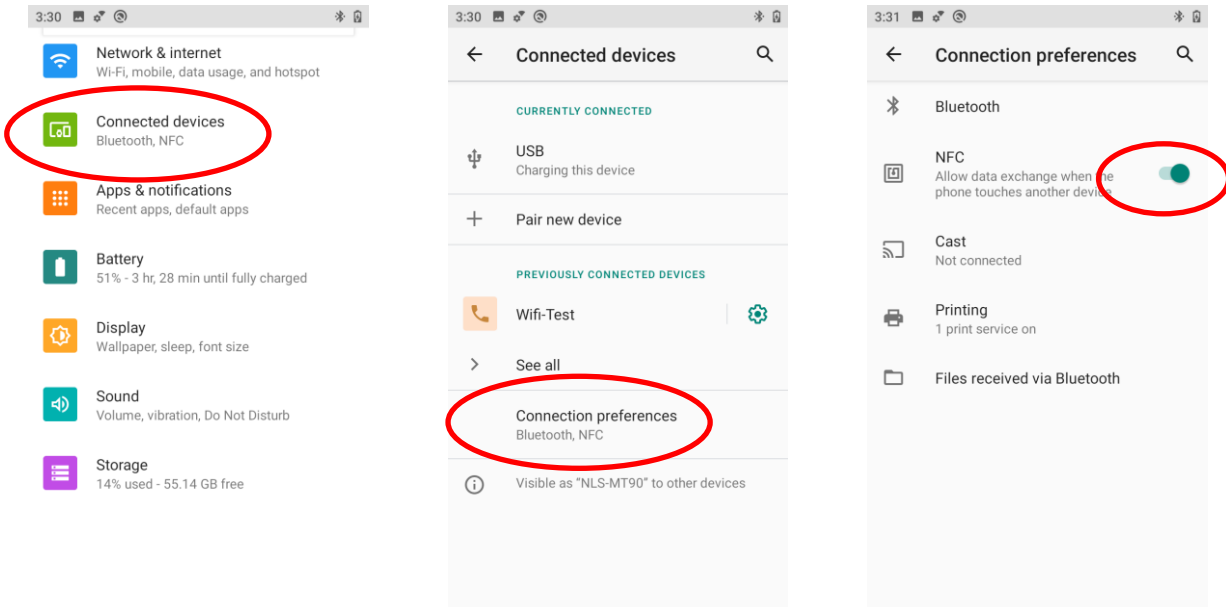

Memory Cleanup

Swipe home screen from bottom to top with one finger in one smooth motion to display all the apps. Then tap  to clean up the memory. It will display clean up note after cleaning.

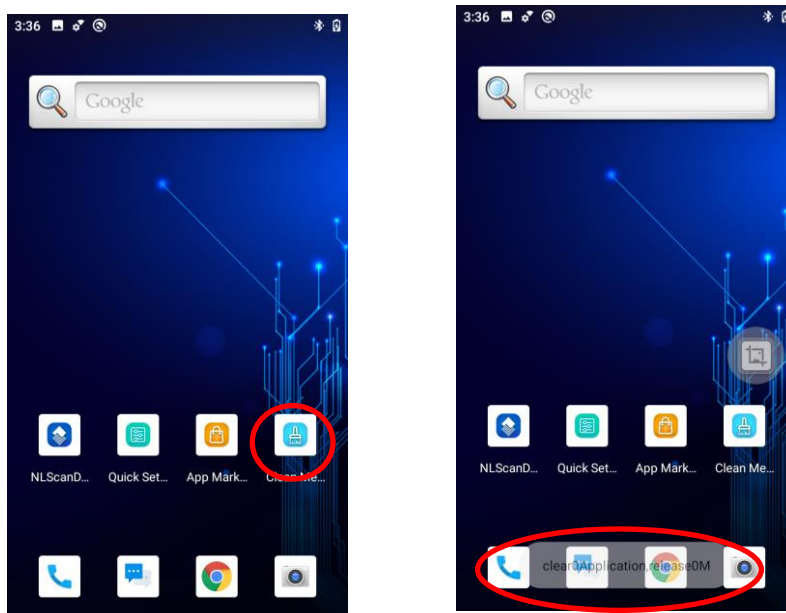



**Note after
Memory clean up**

Note: When your terminal becomes less efficiently after having run for extended periods of time, you may perform a memory cleanup or reboot the terminal to fix the problem.

Key Map

This app allows you to remap the keys on the terminal to function as a different key or to make them into shortcuts to launch an application.

Start the Key map app: Tap the quick setting app icon  on the Home screen then .

Remap a key to another key(or app): After starting the Key map app, select the key you want to remap, and then tap “keys” and select/enter the key (or tap “apps” and select the app) to which you want to remap it.

When remapping a key to KEYCODE_SHOW_SOFT_INPUT, pressing the remapped key can open/close the on-screen keyboard.

Clear All Remap: Clear all remap to return to default settings.

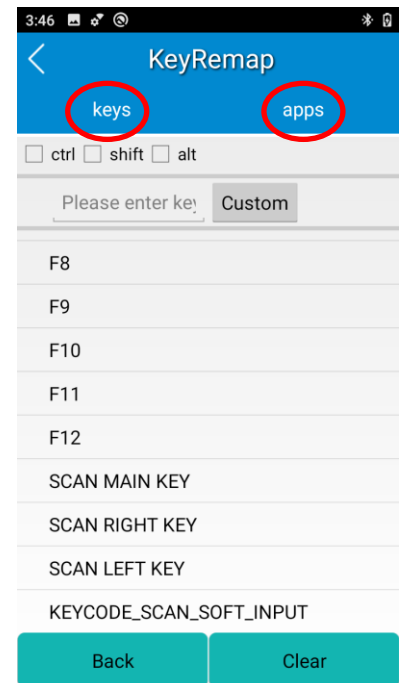
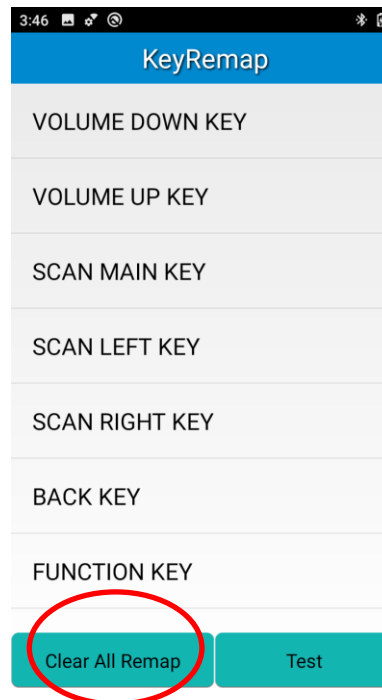
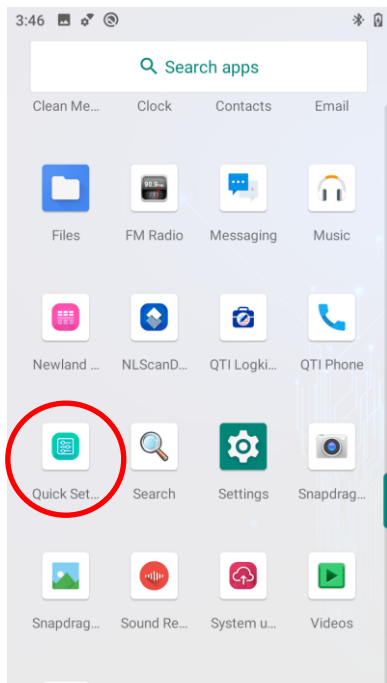

Chapter 9 Admin Tool

Introduction

The Admin Tool app is used to specify the apps that users can run on the MT90.

Launching the Admin Tool

Tap the app icon  to launch the admin tool and enter the User mode. Tap the “Return Key” on the front panel and then enter the password (default: 112233).

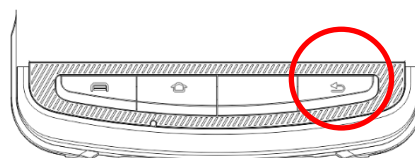
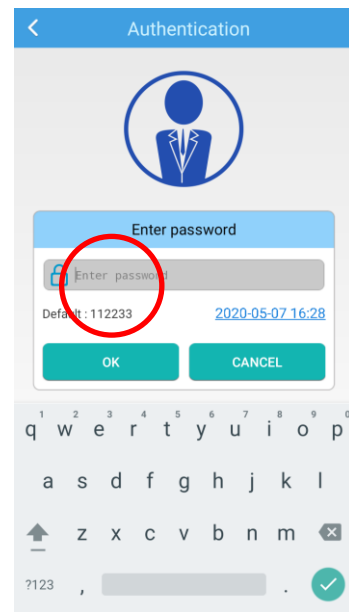
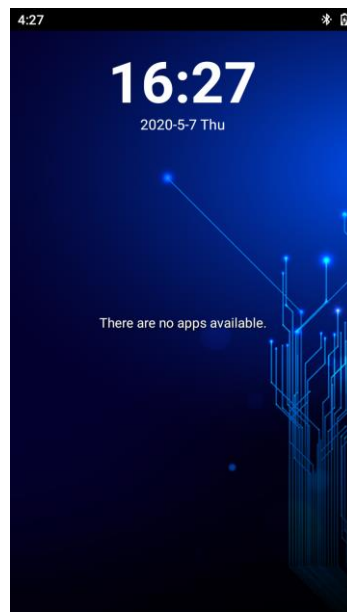
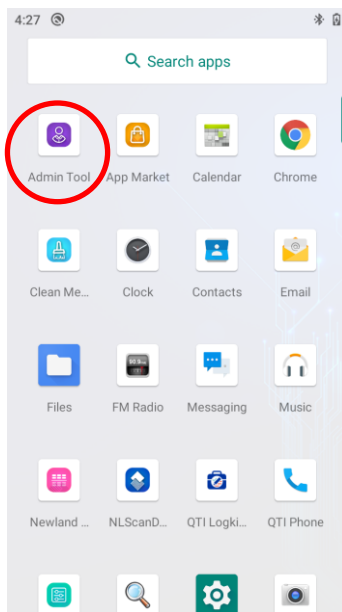

(Return Key)

When in the Admin mode, you may set the following parameters as per your actual needs.

1. App manager: Tap “App Manager” -> “Select App”, then select or deselect the apps available to normal users.

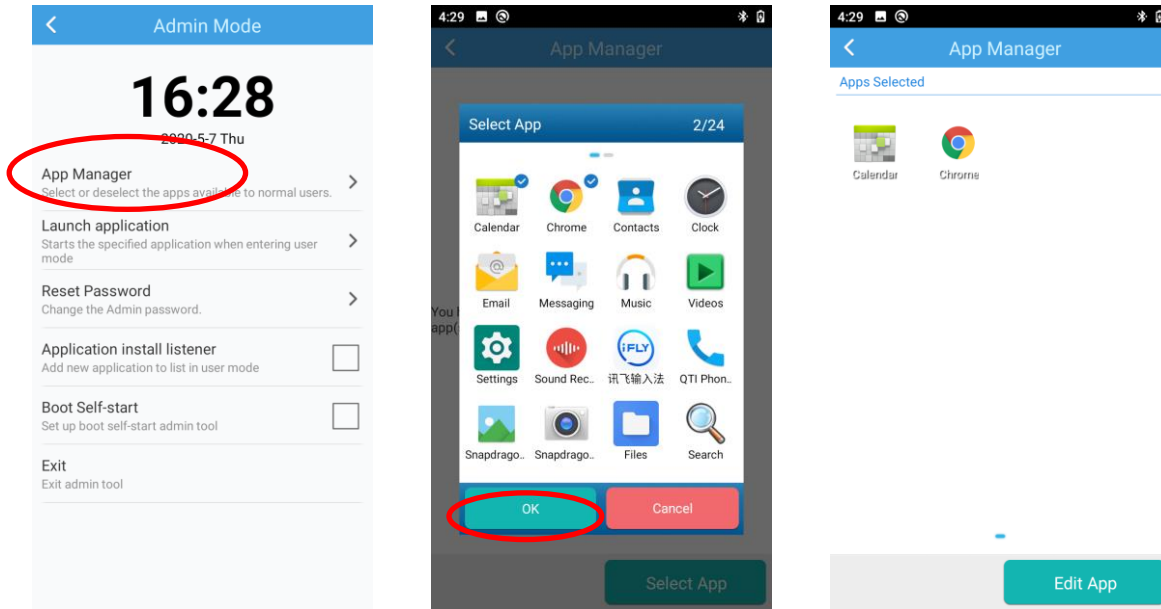

2. Launch application: Starts the specified application when entering user mode. Please note that only one app can be set.

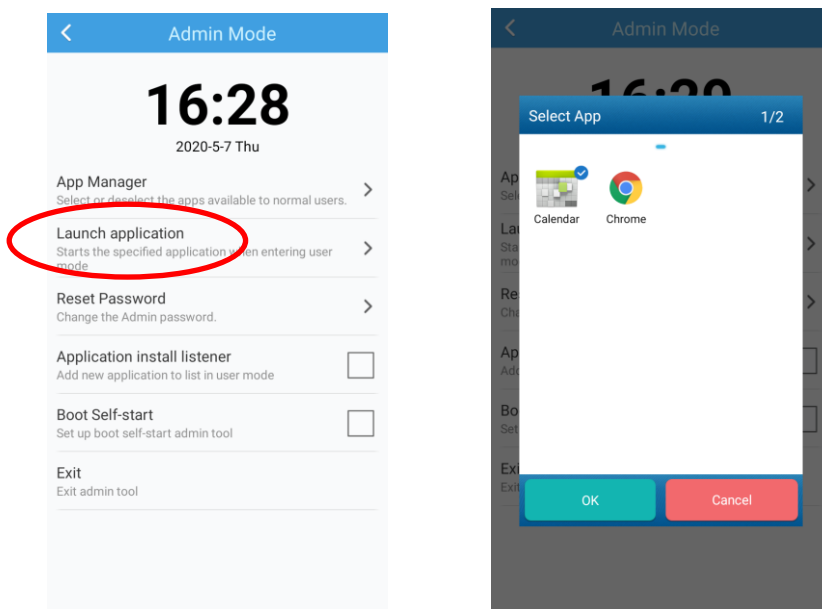

3. Reset password: Change the Admin password.

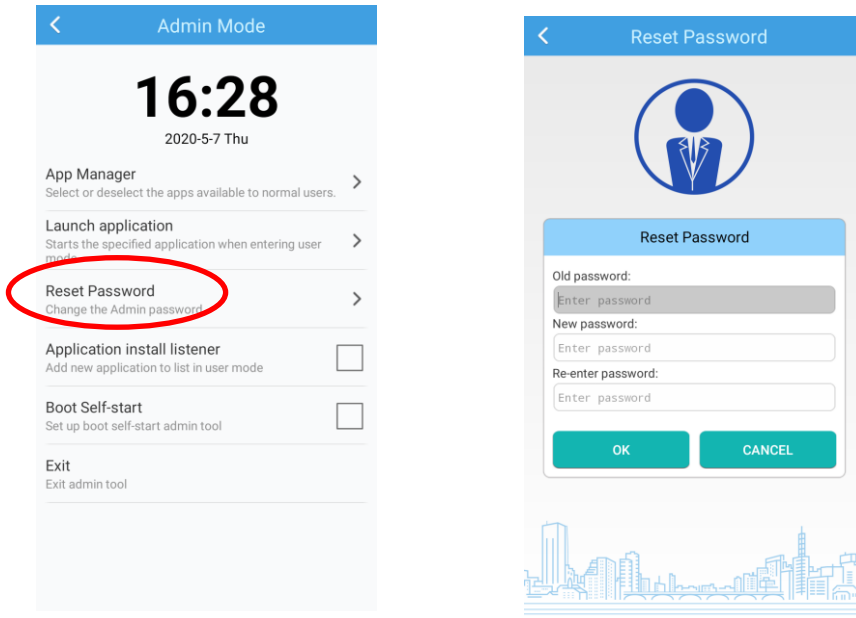

4. Application install listener: Add new application to list in user mode.

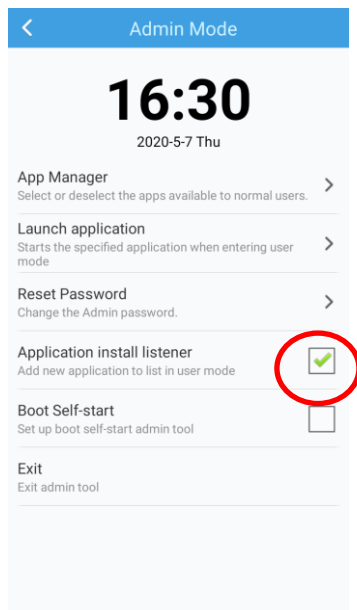

5. Boot self-start: Set up boot self-start admin tool.

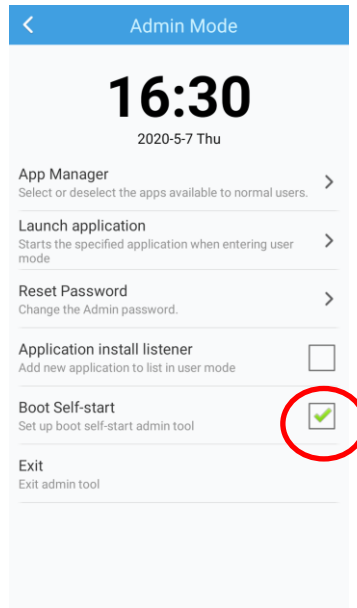

6. Exit: Exit admin tool.

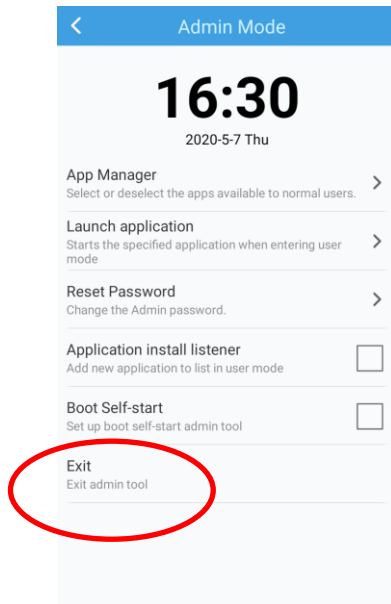



Chapter 10 Whitelist Manager

Introduction

The Whitelist Manager app is used to specify the apps that users can install on the MT90.

Logging in to Whitelist Manager

Tap the app icon  on the Home screen then , enter the password (default: 112233), and tap “Login” to log in to the whitelist manager. Then set up your whitelist as per actual needs.

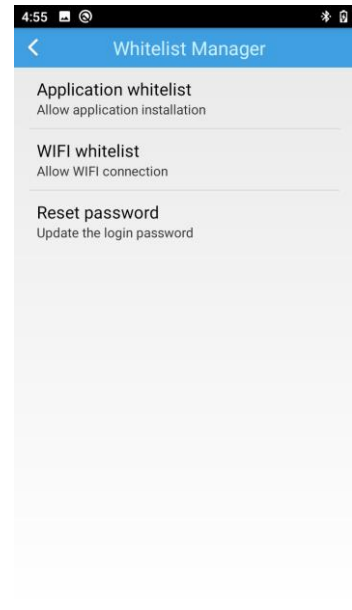
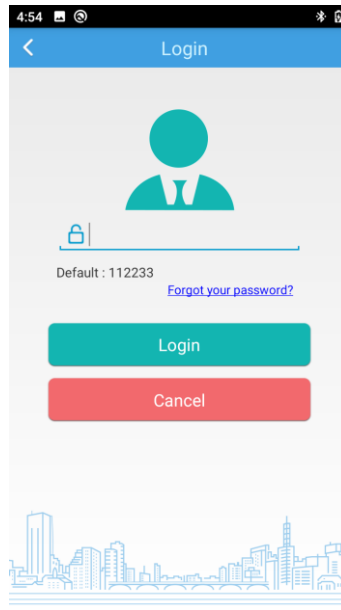
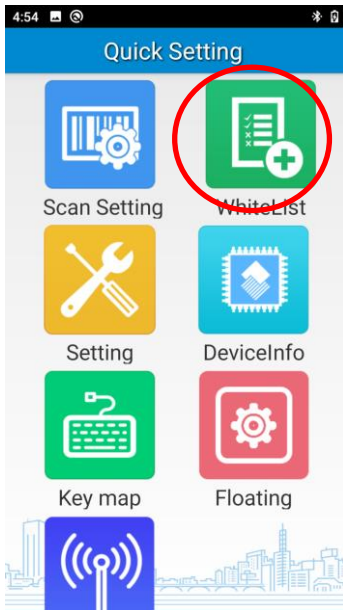

Chapter 11 System Update

This chapter introduces two methods to update the system software of the terminal: Online update and local update.

Online Update

Update the system online: Tap system updates icon  ->“CHECK FOR UPDATES”.

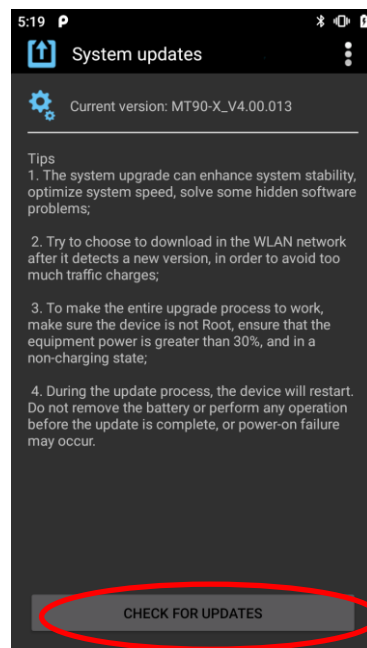
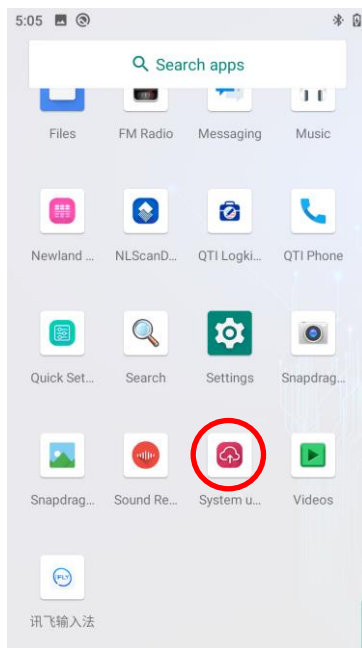

Local Update

Zip File to the MT90 Drive

1. Connect the terminal to PC with the included USB cable. Swipe from top to bottom with one finger in one smooth motion to open the notification bar. Tap “USB for file transfer”. Then select “Transfer files”.



The file name may be different based on each version.

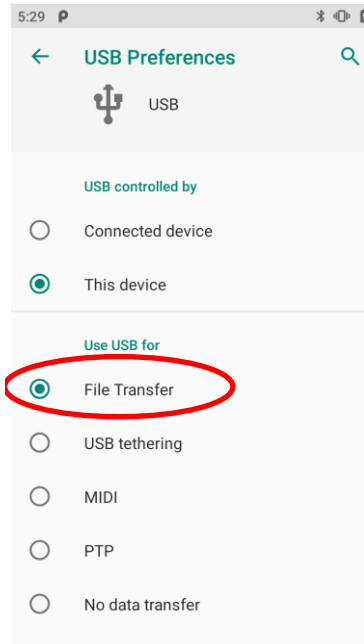

2. Copy the update zip file to the MT90 drive or MT90's Micro SD card.

3. Tap  to access the System Update screen.

4. Tap  in the top right corner of the System Update screen then select "Local Update".

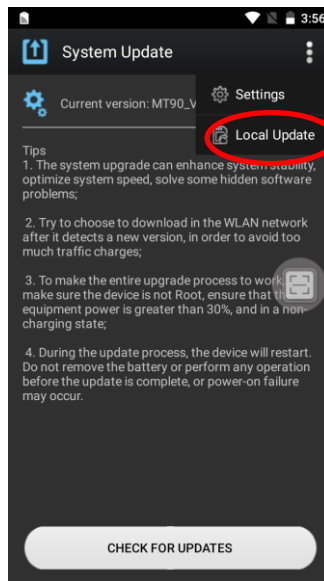

5. Select the update zip file. Then select "NEXTREBOOT" or "UPDATE".

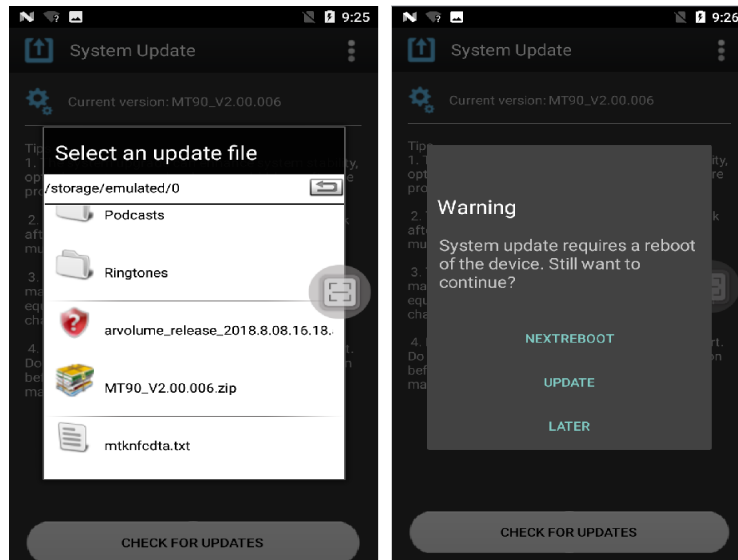

Zip File to TF Card

1. Copy the update zip file to TF Card.

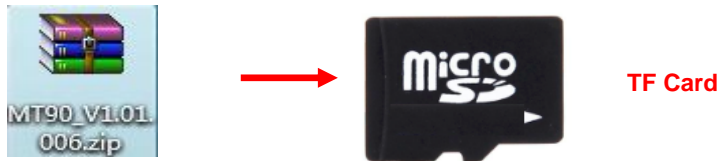

2. Insert the TF card to the MT90 and then power on the terminal.

3. Tap  to access the System Update screen.

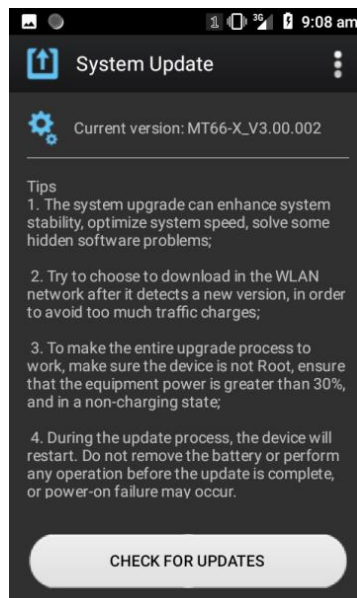

4. Tap  in the top right corner of the System Update screen, and then select “Local Update” -> “External Storage”.

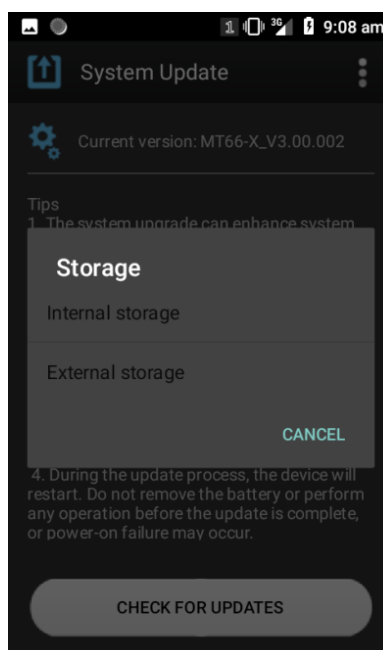
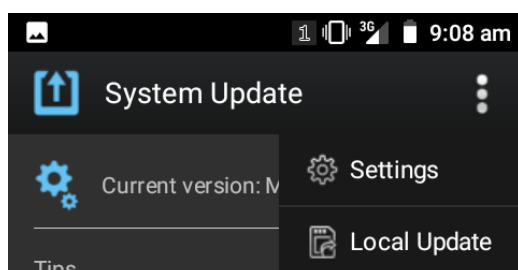

4. Select the update zip file. Then select “NEXTREBOOT” or “UPDATE”.

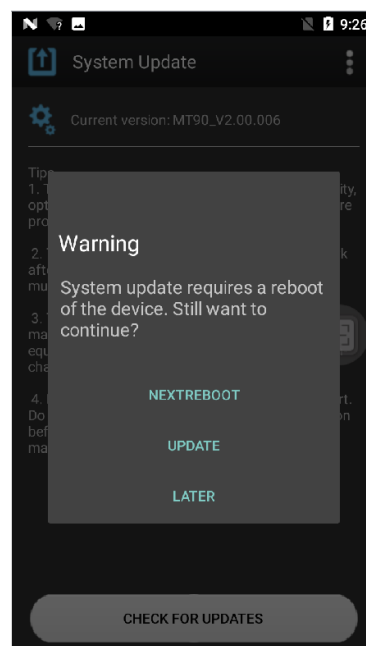

Chapter 12 App Development Guide

Development Environment

The MT90 runs on the Android 10 operating system, so you should use Android SDK 10 or lower when developing apps for the MT90.

Use of Non-Standard Interfaces

See *Newland Android PDA API Handbook*.

Chapter 13 Maintenance & Troubleshooting

Introduction

This chapter includes important safety and handling information and provides troubleshooting solutions for issues that might occur when using the terminal.

Important Safety & Handling Information

Disassembly and Retrofit

Do not attempt to disassemble or retrofit the terminal yourself. Unauthorized disassembly or retrofit will void the warranty.

External Power Supply

Use only the included AC adapter. Otherwise there is a risk of damage to the terminal.

Abnormal Situation

Keep the terminal away from fire or heat sources. If there is unusual odor, overheating or smoke during charging, immediately cut off the power and disconnect the AC adapter, and contact your dealer or Newland customer service center. Continued use in this case may result in fire or electric shock.

Drop Damage

If the terminal is damaged due to a drop from high place, immediately cut off the power and contact your dealer or Newland customer service center.

LCD Screen

Do not press against or strike the LCD screen. Otherwise it may damage the screen. When handling a cracked or shattered screen, do not touch the liquid that has leaked from it to avoid skin burn or infection.

Stacking Heavy Objects

Do not place heavy objects on the terminal as those objects may fall and cause injury.

Mounting Location

Do not place the terminal on unstable or uneven surfaces as it may fall and cause injury. Do not expose the terminal to humidity or dust as this may cause fire or electric shock. Do not expose the terminal to direct sunlight for extended periods.

Wireless Functionalities

Do not use the terminal's wireless functionalities where wireless device use is prohibited or where it may cause interference or danger, such as in aircrafts, petrol stations.

Use & Maintenance

- ✧ If the terminal cannot be switched on after experiencing a sudden or unexpected power loss or other abnormalities, remove and then reinstall its battery to reset the terminal.
- ✧ Do not throw, drop or strike the terminal. Doing so may damage the LCD display, interrupt running programs, cause data loss in memory and result in malfunction.
- ✧ Clean the scan window regularly. Do not touch it with hands. Scratched or smudged window may degrade reading performance.
- ✧ Do not tap the touch screen with sharp objects. Doing so may damage the screen or cause internal short circuits.
- ✧ Use only a dry soft cloth to clean the terminal. Cleaning it with wet cloth or benzene/ thinner/ other volatile chemicals may deform and shorten the service life of the keypad and shell of the terminal.
- ✧ Do not place the terminal face down on any surface, or there might be misoperations.
- ✧ Sudden temperature drops may cause condensation on the shell which could cause malfunction. Care should be taken to avoid condensation. If condensation occurs, dry the terminal before use.

Battery Safety Guidelines

- ✧ **Do not dispose of batteries in a fire as they may explode.**
- ✧ The battery can be charged and discharged over 500 times. If the battery life is unreasonably short, please replace the battery with a new one.
- ✧ Use only the included battery and AC adapter.
- ✧ Do not continue to charge a battery that is fully charged. Overcharging will shorten battery lifespan. If a fully charged battery is not used, it will discharge slowly, which does not affect its normal use.
- ✧ Do not use damaged or faulty AC adapters or batteries.
- ✧ **Properly dispose of and recycle batteries. Do not dispose of them as household garbage.**

Troubleshooting

Problem		Possible Cause & Solution
Type	Description	
Keypad	Unresponsive keypad or incorrect response to any key entry.	This problem may be caused by unreliable cable connection between keypad and mainboard or keypad malfunction. Please contact Newland after-sales service.
Battery	Charging LED is OFF when charging.	Ensure the AC adapter is plugged in properly.
	Noticeably short battery life.	1. Check the battery level. If the battery is almost depleted, recharge it. 2. Replace the battery if it is faulty.
	Fully charged battery is depleted after the terminal is switched on.	If the battery is faulty, replace it with a new one.
USB	USB communication failure	1. Ensure that the USB cable connections are secure. 2. Ensure that there is no contaminant inside the Micro USB port. 3. If the problem remains, please contact the after-sales service center.
LCD Screen	No display	1. Ensure the terminal is switched on. 2. If the terminal is in sleep mode, press the Power key to wake it up. 3. Check the battery level. If the battery is depleted, recharge it. 4. Ensure that the battery is properly installed. 5. Replace the battery if it is faulty. 6. If the problem remains, please contact the after-sales service center.
System	Cannot switch on	1. Check the battery level. If the battery is depleted, recharge it. 2. Switch the terminal on after using the included AC adapter to connect it to a power outlet. If the problem disappears, then continue to charge the terminal. If the problem remains after charging the terminal for a while, replace the battery.
	System halted	1. The problem may be caused by bugs in downloaded apps. Ensure that only reliable apps are used. 2. The problem may be caused by a sudden or unexpected power loss. Remove and then reinstall its battery to reset the terminal.



Newland

SCANNING MADE SIMPLE

Newland EMEA HQ
+31 (0) 345 87 00 33
info@newland-id.com
newland-id.com

Need more info? Contact us or one of
our partners at newland-id.com/partners