

**SAMSUNG**

# USER MANUAL

SM-R900  
SM-R905F  
SM-R910  
SM-R915F  
SM-R920  
SM-R925F

# Table of Contents

## Getting started

### 5 About the Galaxy Watch5 Pro / Galaxy Watch5

### 6 Device layout and functions

- 6 Watch
- 11 Wireless charger

### 12 Charging the battery

- 12 Wireless charging
- 13 Charging the battery using Wireless power sharing
- 14 Battery charging tips and precautions

### 16 Wearing the Watch

- 16 Connecting the band
- 17 Putting on the Watch
- 20 Band tips and precautions
- 21 How to wear the Watch for accurate measurements

### 23 Turning the Watch on and off

### 24 Connecting the Watch to a smartphone

- 24 Installing the Galaxy Wearable app
- 24 Connecting the Watch to a smartphone via Bluetooth
- 26 Remote connection

### 26 Controlling the screen

- 26 Bezel
- 27 Touchscreen
- 28 Screen composition
- 29 Turning the screen on and off
- 29 Switching the screen
- 30 Lock screen

### 31 Watch

- 31 Watch screen
- 31 Changing the watch face
- 32 Activating the Always On Display feature
- 32 Activating watch only mode

### 33 Notifications

- 33 Notification panel
- 33 Viewing incoming notifications
- 34 Selecting apps for receiving notifications

### 34 Quick panel

### 37 Entering text

- 37 Keyboard layout

## Apps and features

### 39 Installing and managing apps

- 39 Play Store
- 39 Managing apps

### 40 Messages

<b>42</b>	<b>Phone</b>	<b>83</b>	<b>Reminder</b>
42	Introduction	<b>84</b>	<b>Calendar</b>
42	Making calls	<b>84</b>	<b>Bixby</b>
44	Options during calls	<b>85</b>	<b>Weather</b>
44	Receiving calls	<b>86</b>	<b>Alarm</b>
<b>45</b>	<b>Contacts</b>	<b>86</b>	<b>World Clock</b>
<b>46</b>	<b>Samsung Pay</b>	<b>87</b>	<b>Timer</b>
<b>47</b>	<b>Samsung Health</b>	<b>87</b>	<b>Stopwatch</b>
47	Introduction	<b>88</b>	<b>Gallery</b>
47	Daily activity	88	Importing and exporting images
48	Steps	88	Viewing images
50	Exercise	89	Deleting images
58	Food	<b>89</b>	<b>Find My Phone</b>
59	Sleep	<b>90</b>	<b>Find My Watch</b>
61	Body composition	<b>91</b>	<b>Sending an SOS</b>
64	Women's health	91	Introduction
66	Heart rate	91	Registering the emergency contacts
68	Stress	91	Requesting an SOS
69	Blood oxygen	92	Requesting an SOS when you are hurt from a fall
71	Water	93	Stopping SOS messages
72	Together	<b>93</b>	<b>Voice Recorder</b>
72	Settings	<b>94</b>	<b>Calculator</b>
<b>73</b>	<b>Samsung Health Monitor</b>	<b>94</b>	<b>Compass</b>
73	Introduction	<b>95</b>	<b>Buds Controller</b>
73	Precautions for measuring blood pressure and ECG	<b>95</b>	<b>Camera Controller</b>
76	Starting to measure the blood pressure	<b>95</b>	<b>Samsung Global Goals</b>
78	Starting to measuring the ECG	<b>96</b>	<b>Google apps</b>
<b>81</b>	<b>GPS</b>		
<b>81</b>	<b>Music</b>		
<b>82</b>	<b>Media Controller</b>		
82	Introduction		
82	Controlling the music player		
82	Controlling the video player		

## **96 Settings**

- 96 Introduction
- 96 Samsung account
- 96 Connections
- 100 Notifications
- 100 Sounds and vibration
- 101 Display
- 101 Samsung Health
- 102 Advanced features
- 102 Battery
- 103 Apps
- 103 General
- 104 Accessibility
- 104 Security
- 104 Privacy
- 105 Location
- 105 Safety and emergency
- 105 Accounts and backup
- 106 Google
- 106 Software update
- 106 Tips and tutorials
- 106 About watch

## **Galaxy Wearable app**

- 107 Introduction**
- 108 Watch faces**
- 109 Apps screen**
- 110 Tiles**
- 110 Quick panel**
- 111 Watch settings**
  - 111 Introduction
  - 111 Samsung account
  - 111 Notifications
  - 111 Sounds and vibration

- 112 Display
- 112 Samsung Health
- 112 Advanced features
- 112 Battery
- 112 Apps
- 113 Manage content
- 114 Mobile plans (SM-R905F, SM-R915F, SM-R925F)
- 114 General
- 114 Accessibility
- 114 Safety and emergency
- 115 Accounts and backup
- 117 Watch software update
- 117 About watch

## **117 Find My Watch**

## **118 Tips and user manual**

## **118 Store**

## **Usage notices**

- 119 Precautions for using the device**
- 121 Notes on package contents and accessories**
- 122 Maintaining the device's water and dust resistance**
- 124 Precautions for overheating**
- 124 Cleaning and managing the Watch**
- 125 Use caution if you are allergic to any materials on the Watch**

## **Appendix**

- 126 Troubleshooting**
- 130 Removing the battery**

# Getting started

## About the Galaxy Watch5 Pro / Galaxy Watch5

The Galaxy Watch5 Pro / Galaxy Watch5 (hereafter, Watch) is a smartwatch that can analyse your exercise pattern, manage your health and allows you to use a variety of convenient apps for making phone calls and playing music. You can easily browse the various features by using the bezel or launch a feature by simply tapping the screen and also change the watch face to match your taste.

You can use your Watch after connecting it to your smartphone.

# Device layout and functions

## Watch

### ► Galaxy Watch5 Pro:

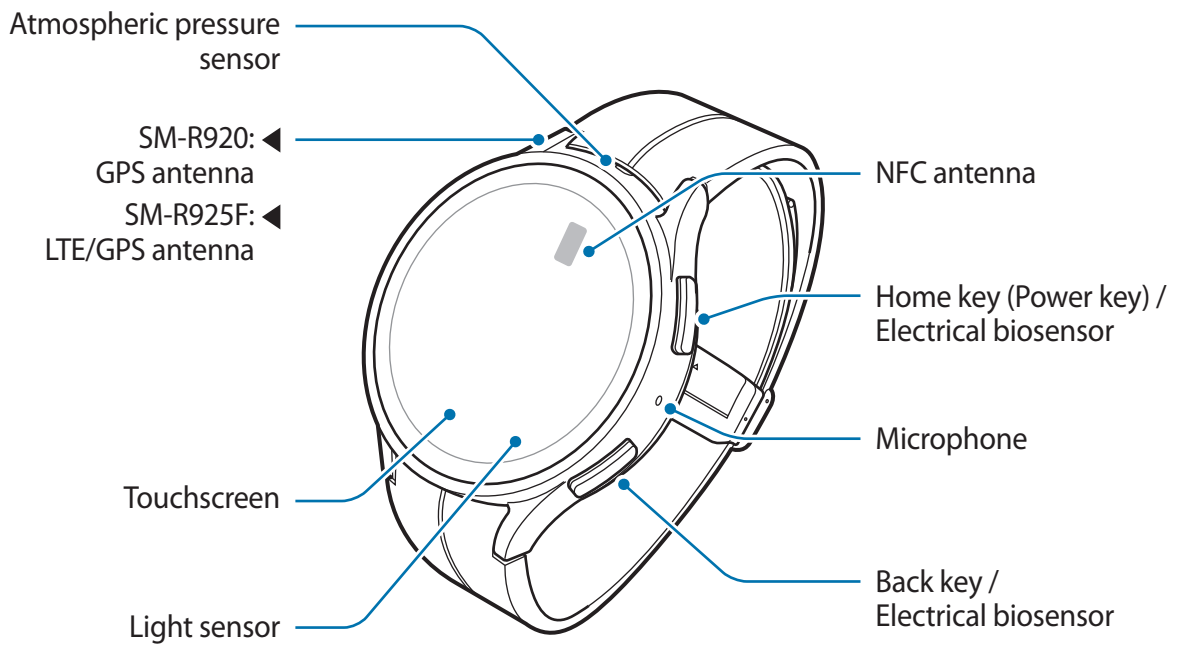

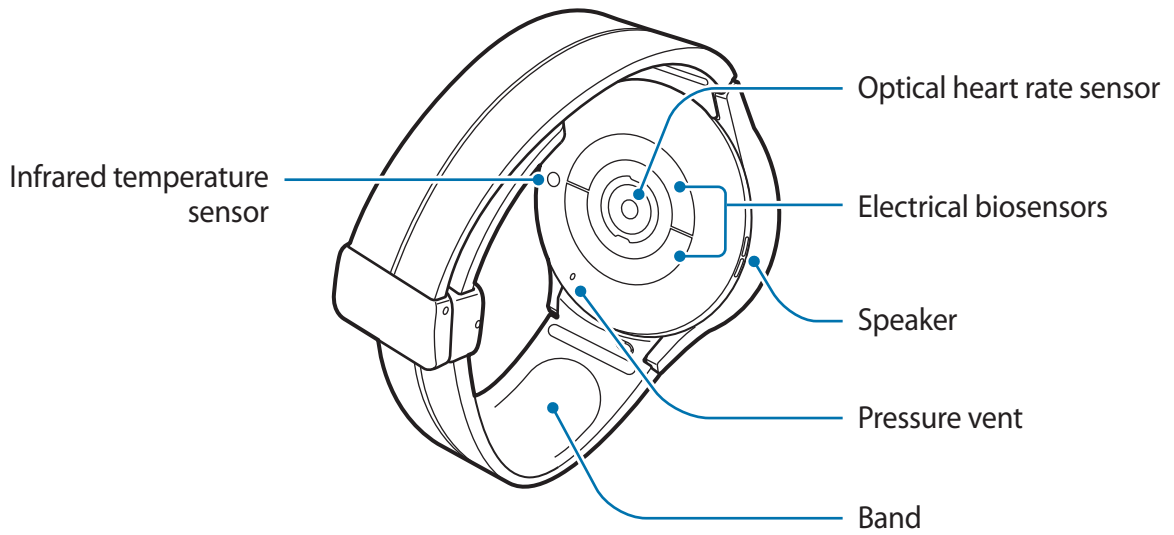
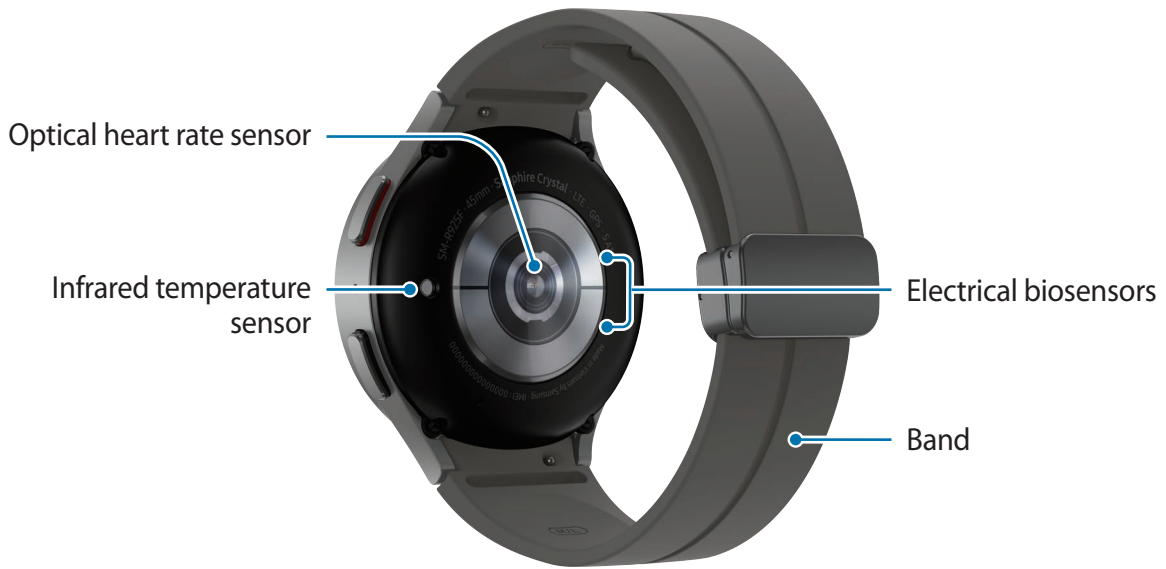



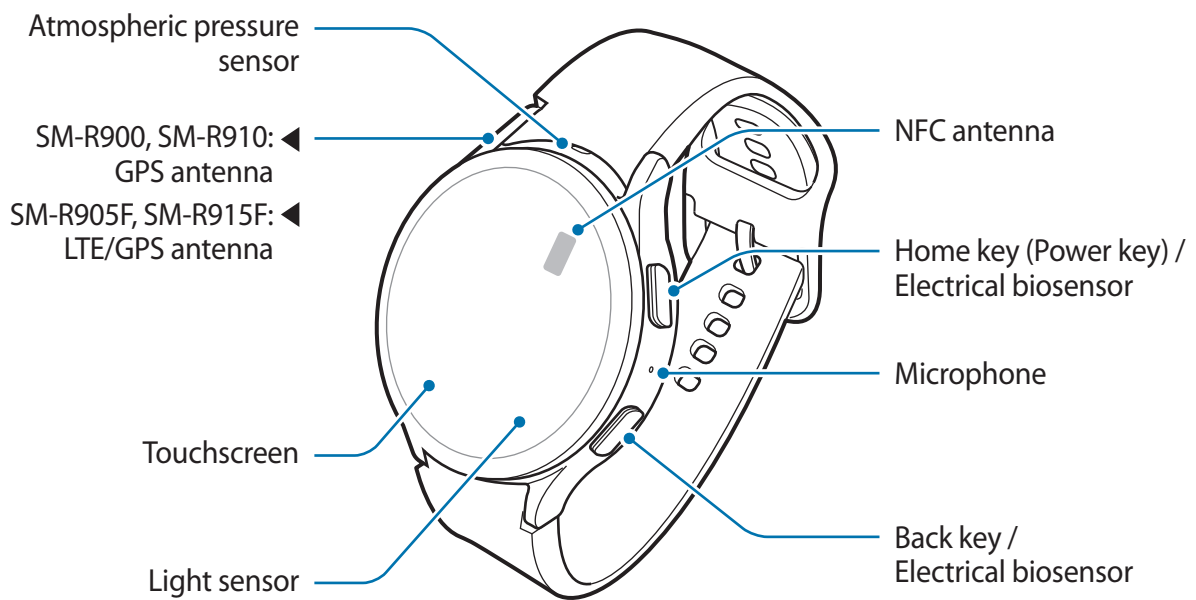
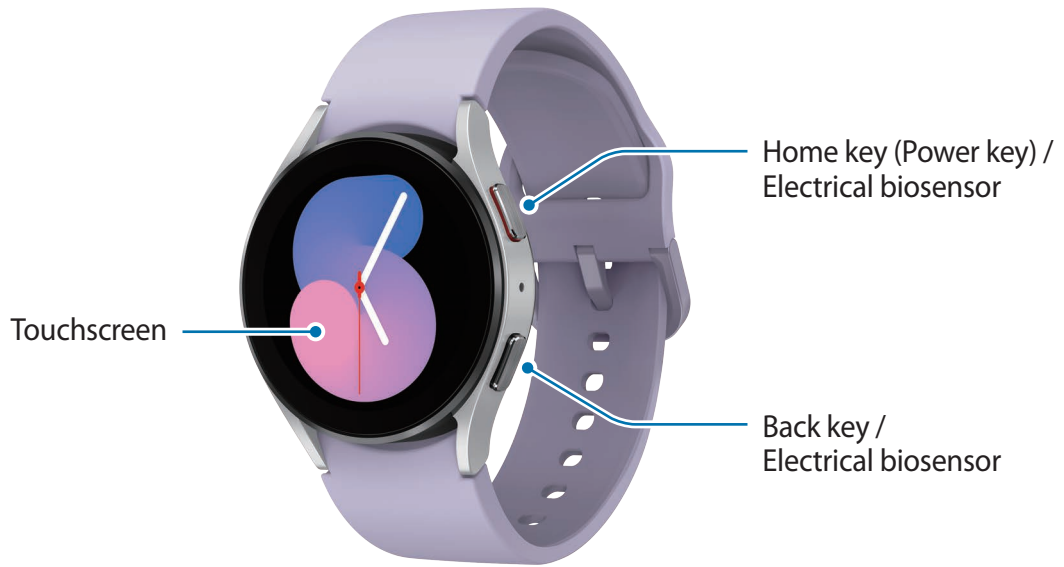

► **Galaxy Watch5:**

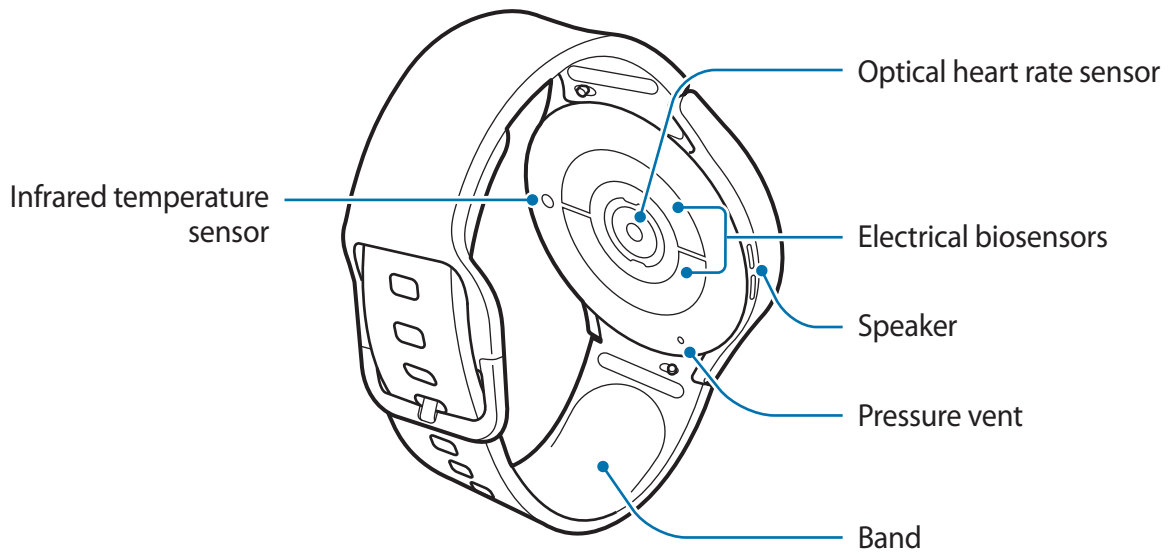
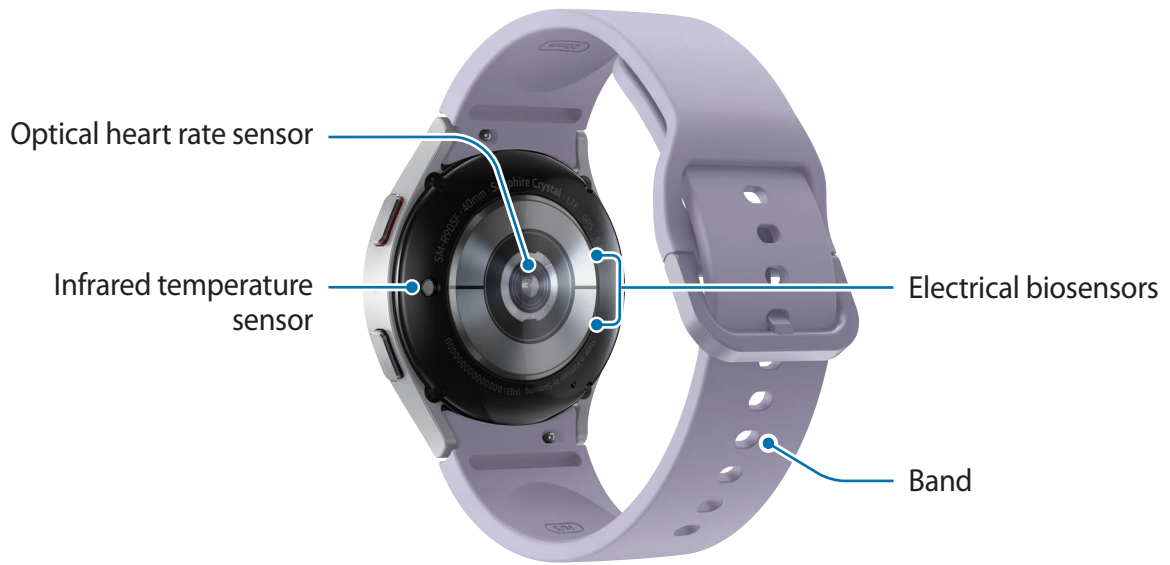





-  The device and some accessories (sold separately) contain magnets. The American Heart Association (US) and the Medicines and Healthcare Products Regulatory Agency (UK) both warn that magnets can affect the operation of implanted pacemakers, cardioverters, defibrillators, insulin pumps or other electro medical devices (collectively, “Medical Device”) within the range of 15 cm (6 inches). If you are a user of any of these Medical Devices, **DO NOT USE THIS DEVICE AND SOME ACCESSORIES (SOLD SEPARATELY) UNLESS YOU HAVE CONSULTED WITH YOUR PHYSICIAN.**
- 
  - Do not store your device and some accessories (sold separately) near magnetic fields. Magnetic stripe cards, including credit cards, phone cards, passbooks, and boarding passes, may be damaged by magnetic fields.
  - When using the speakers, such as when playing media files, do not place the Watch close to your ears.
  - Ensure that the band is kept clean. Contact with contaminants, such as dust and dye, can cause stains on the band that may not be fully removed.
  - Do not insert sharp objects into the Watch’s external holes. The inner components may be damaged along with the water-resistance feature.
  - If you use the Watch with its glass body broken, there may be a risk of injury. Use the Watch only after it has been repaired at a Samsung Service Centre or an authorised service centre.
  - If dust or foreign materials enter the microphone or speaker, the Watch’s sound may become quiet or certain features may not work. If you attempt to remove the dust or foreign materials with a sharp object, the Watch may be damaged and its appearance may be affected.
- 
  - Connectivity problems and battery drain may occur in the following situations:
    - If you attach metallic stickers on the antenna area of the Watch
    - If you use a metallic band
    - If you cover the device’s antenna area with your hands or other objects while using certain features, such as calls or the mobile data connection
  - Do not cover the light sensor area with accessories, such as stickers or a cover. Doing so may cause the sensor to malfunction.
  - Make sure the Watch’s microphone is not obstructed when you are speaking into it.
  - The pressure vent ensures that Watch’s inner parts and sensors work correctly when you use the Watch in environment where the atmospheric pressure changes.
  - The images in this manual are of a Galaxy Watch5 Pro.

## Keys

Key	Function
Home key	<ul style="list-style-type: none"> <li>• When the Watch is off, press and hold to turn it on.</li> <li>• When the screen is off, press to turn on the screen.</li> <li>• Press and hold to start a conversation with Bixby. Refer to <a href="#">Using Bixby</a> for more information.</li> <li>• Press twice or press and hold to launch the app or feature you set. (⚙️ (Settings) → <b>Advanced features</b> → <b>Customise keys</b>)</li> <li>• Press to open the Watch screen when you are on any other screen.</li> </ul>
Back key	<ul style="list-style-type: none"> <li>• When the screen is off, press to turn on the screen.</li> <li>• Press to launch the feature you set. (⚙️ (Settings) → <b>Advanced features</b> → <b>Customise keys</b>)</li> </ul>
Home key + Back key	<ul style="list-style-type: none"> <li>• Press simultaneously to capture a screenshot.</li> <li>• Press and hold simultaneously to turn off the Watch.</li> </ul>

## Wireless charger

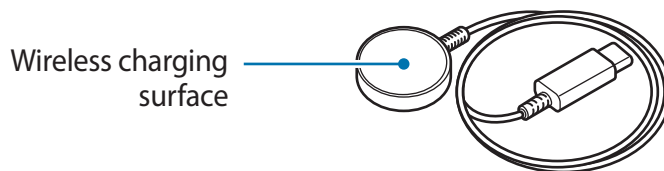

- ⚠️ Do not expose the wireless charger to water because the wireless charger does not have same water-resistance certification as your Watch.

## Charging the battery

Charge the battery before using it for the first time or when it has been unused for extended periods.

### Wireless charging

- 1 Connect the wireless charger to the USB power adaptor.
- 2 Place the Watch on the wireless charger aligning the centre of your Watch's back side with the centre of the wireless charger. Wireless charging may not work smoothly depending on the type of accessory or cover. For stable wireless charging, it is recommended to separate the cover or accessory from the Watch.

► **When connecting the D-Buckle Sport Band (only for models that include this band):**

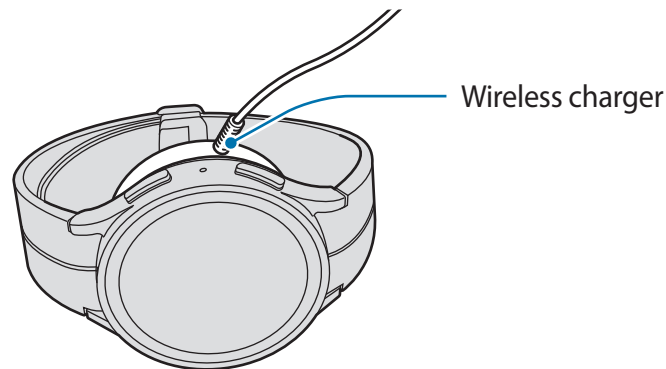

► **When connecting other bands:**

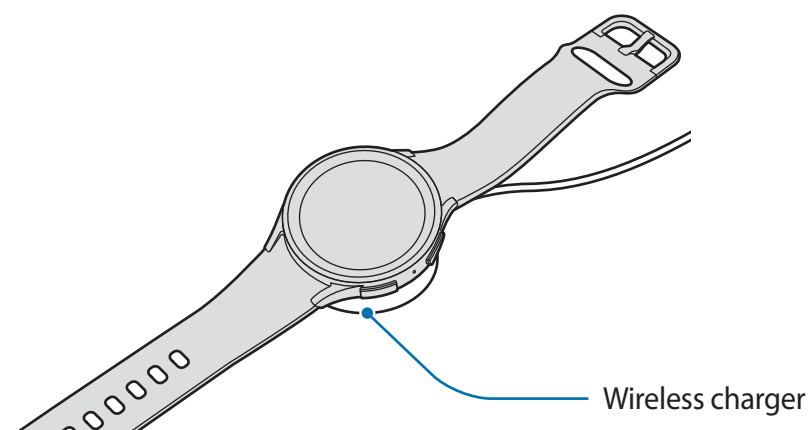

- 3 After fully charging, disconnect the Watch from the wireless charger.

## Checking the charging status

You can check the charging status on the screen during wireless charging. If the charging status does not appear on the screen, on the Apps screen, tap  (**Settings**) → **Display** and tap the **Show charging info** switch to activate it.

If you charge the Watch when it is turned off, press any key to check the charging status on the screen.



## Charging the battery using Wireless power sharing

You can charge your Watch with the battery of the device that functions as a wireless charging pad. You can still charge your Watch even while charging the device that functions as a wireless charging pad. Depending on the type of cover being used, the Wireless power sharing feature may not work properly. It is recommended to remove any cover being used from the device that functions as a wireless charging pad and your Watch before using this feature.

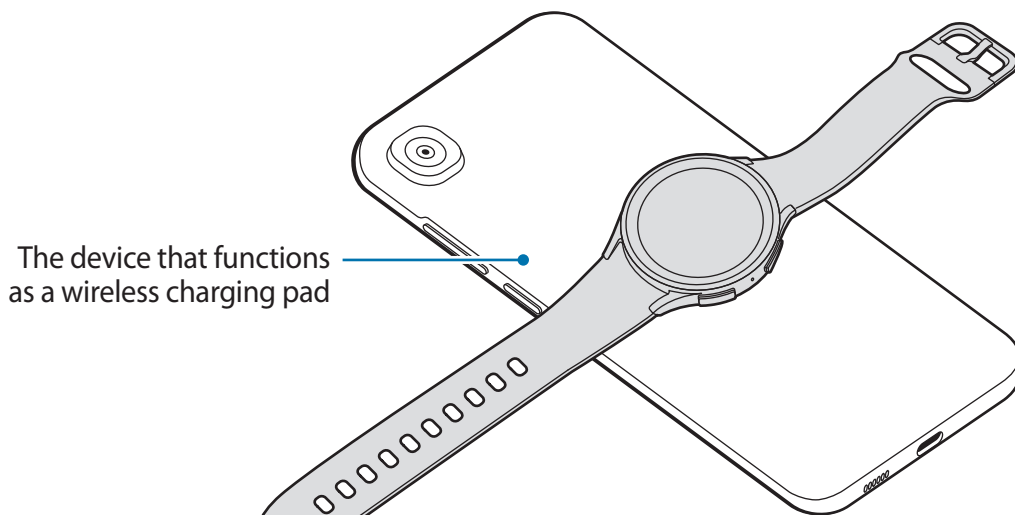

- 1 Turn on the Wireless power sharing feature on the device that functions as a wireless charging pad and place the centre of the Watch's back on the back side of device that functions as a wireless charging pad.



2 After fully charging, disconnect the Watch from the device that functions as a wireless charging pad.

-  Do not use the earphones or Bluetooth headset while sharing power. Doing so may affect nearby devices.
- 
  - You cannot charge your Watch with the wireless charging pad/device that functions as a wireless charging pad after connecting the D-Buckle Sport Band to your Watch due to its structure.
  - The location of the wireless charging coil may vary by device model. Adjust the device or Watch to connect with each other properly.
  - Some features that work while wearing the Watch are not available while sharing power.
  - To charge properly, do not move or use the device that functions as a wireless charging pad or Watch while charging.
  - The power charged to your Watch may be less than the amount shared to it by the device that functions as a wireless charging pad.
  - If you charge the Watch while charging the device that functions as a wireless charging pad, the charging speed may decrease or the Watch may not charge properly, depending on the charger type.
  - The charging speed or efficiency may vary depending on the condition of the device that functions as a wireless charging pad or the surrounding environment.
  - If the remaining battery power of the device that functions as a wireless charging pad drops below a certain level, power sharing will stop.

## Battery charging tips and precautions

-  Use only Samsung-approved charger and cable specifically designed for your Watch. Incompatible charger and cable can cause serious injuries or damage to your device.
- 
  - Connecting the charger improperly may cause serious damage to the device. Any damage caused by misuse is not covered by the warranty.
  - Use only wireless charger supplied with the device. The Watch cannot be charged properly with a third-party wireless charger.
  - If you charge the Watch while the wireless charger is wet, the Watch may be damaged. Thoroughly dry the wireless charger before charging the Watch.





- To save energy, unplug the charger when not in use. The charger does not have a power switch, so you must unplug the charger from the electric socket when not in use to avoid wasting power. The charger should remain close to the electric socket and easily accessible while charging.
- The Watch has a built-in wireless charging coil. You can charge the battery by using a wireless charging pad. However, you cannot charge your Watch with the wireless charging pad/device that functions as a wireless charging pad after connecting the D-Buckle Sport Band to your Watch due to its structure. Also, the wireless charging pad is sold separately. For more information about available wireless charging pads, refer to the Samsung website.
- When using a charger, it is recommended to use an approved charger that guarantees the charging performance.
- If there are obstructions between the Watch and the wireless charger, it may not charge properly. Check if there is any sweat, liquid, or dust on them before charging.
- If the battery is completely discharged, the Watch cannot be turned on immediately when the wireless charger is connected. Allow a depleted battery to charge for a few minutes before turning it on.
- If you use multiple apps at once, network apps, or apps that need a connection to another device, the battery will drain quickly. To avoid losing power during a data transfer, always use these apps after fully charging the battery.
- When connecting the wireless charger to another power source, such as a computer or multi-charging hub, the Watch may not charge properly or it may charge more slowly due to a lower electric current.
- The Watch can be used while it is charging, but it may take longer to fully charge the battery.
- If the Watch's power supply is unstable while being used and charged at the same time, the touchscreen may not function. If this happens, disconnect the Watch from the wireless charger.
- While charging, the Watch may heat up. This is normal and should not affect the Watch's lifespan or performance. Before wearing the Watch, allow it to cool down for a while before using it. If the battery gets hotter than usual, the charger may stop charging.
- If the Watch is not charging properly, visit a Samsung Service Centre or an authorised service centre.
- Avoid using a bent or damaged wireless charger cable. If the wireless charger cable is damaged, stop using it.

## Wearing the Watch

### Connecting the band

Connect the band before using your Watch. You can detach the band from the Watch and replace it with a new one. Remove the band in the reverse order of how you connected it.

 Be careful not to hurt your fingernail when sliding the spring bar while connecting or replacing bands.

-  • The supplied band may vary depending on the region or model.
- The supplied band's size may vary depending on the model. Use the proper band which fits your model's size.

1 Insert one end of the band's spring bar into the Watch's lug.

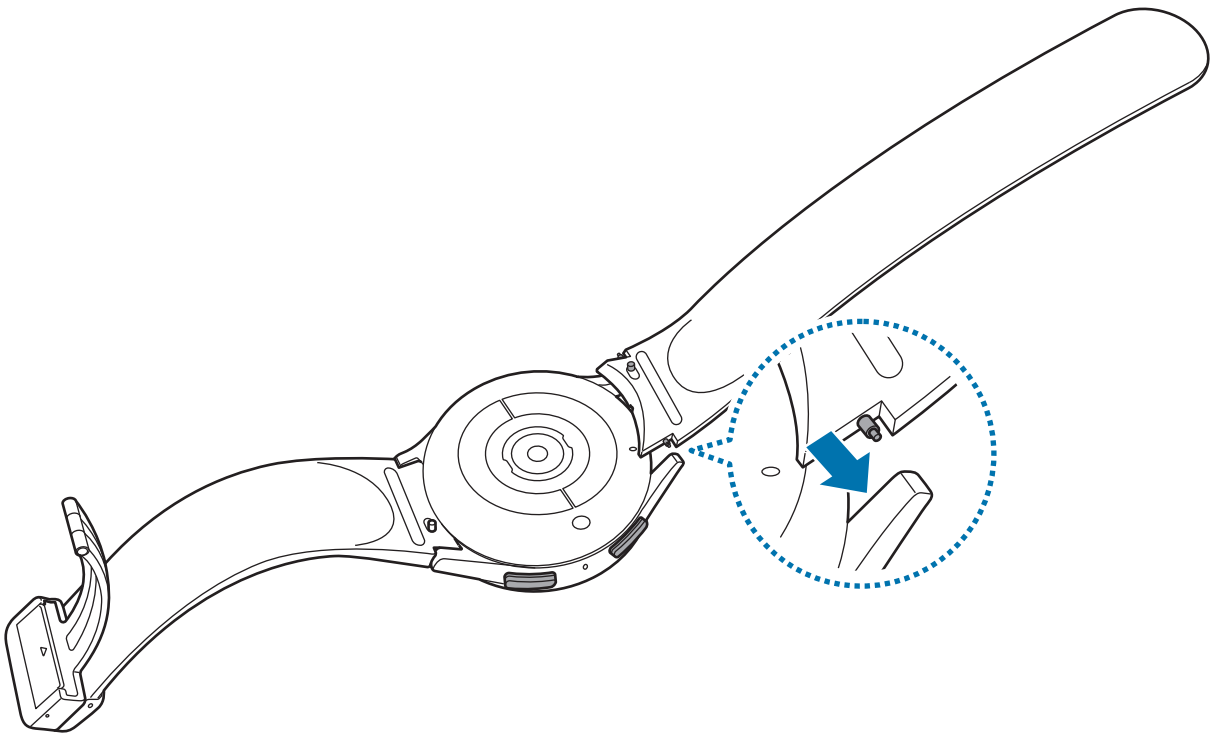



2 Slide the spring bar inwards and connect the band.

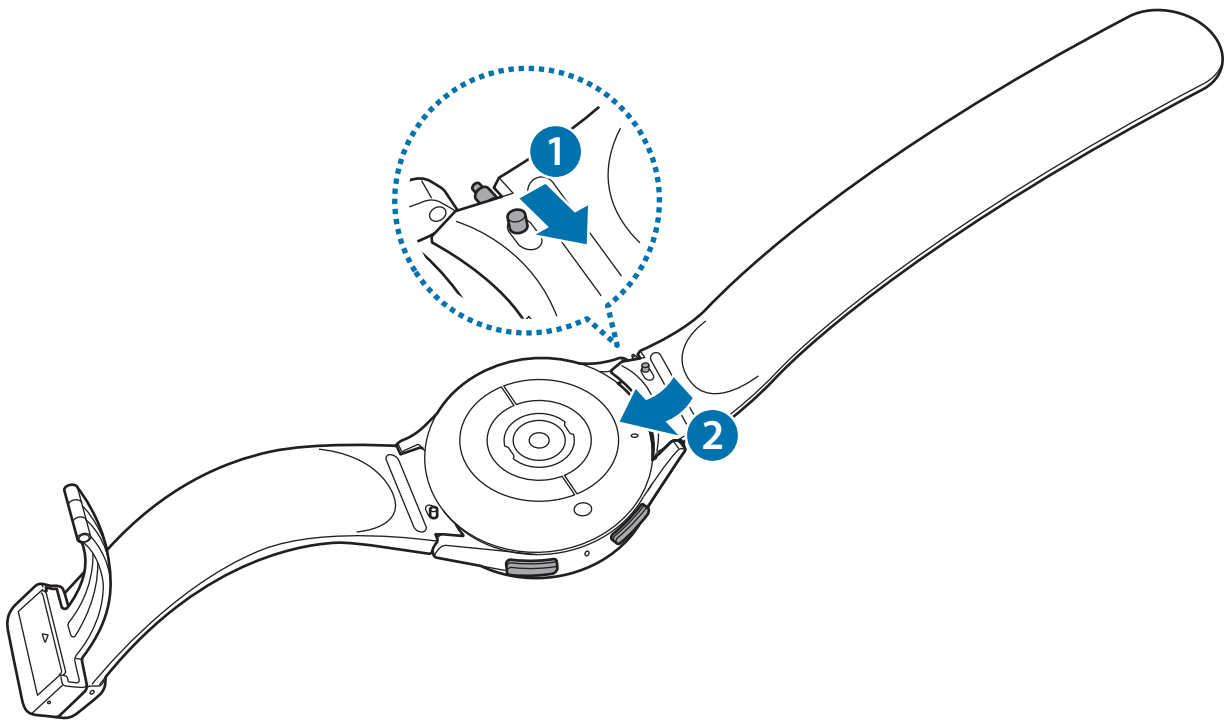

## Putting on the Watch

- ⚠ Do not bend the band excessively. Doing so may damage the Watch.
- 👉
  - To measure your physical condition accurately, wear the Watch firmly around your lower arm above the wrist. Refer to [How to wear the Watch for accurate measurements](#) for more information.
  - When certain materials come into contact with the back of the Watch, your Watch may recognise that you are wearing it on your wrist.
  - If the sensors on the back of your Watch do not come into contact with your wrist for more than 10 minutes, your Watch may recognise that you are not wearing it on your wrist.

► When connecting the D-Buckle Sport Band (only for models that include this band):

- 1 Open the buckle.

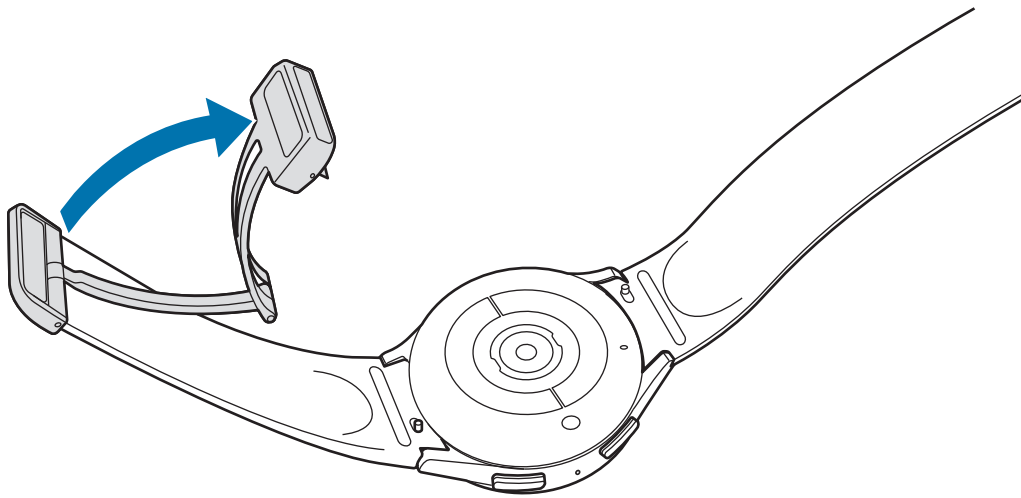

⚠ Do not use excessive force when opening the buckle. Be careful when handling it because the buckle may be deformed and it may affect wearing the band.

- 2 Open the lever, insert the band into the buckle's hole, adjust the band, and then close the lever.

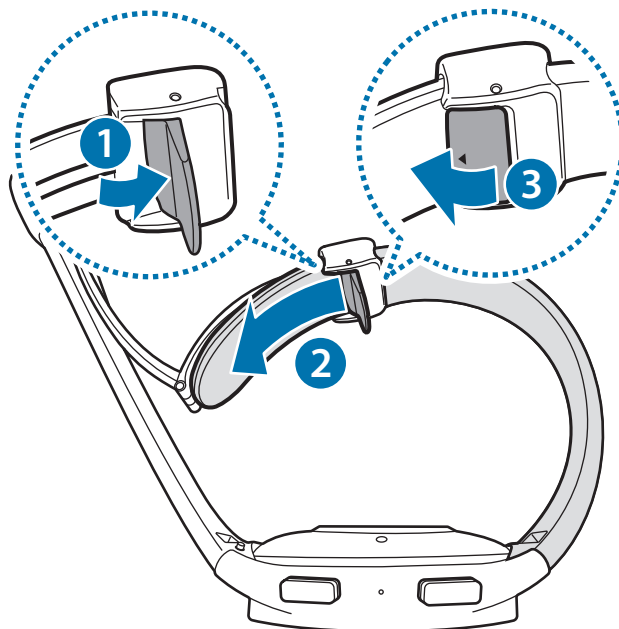

To open the lever after inserting the band, pull the band downwards.

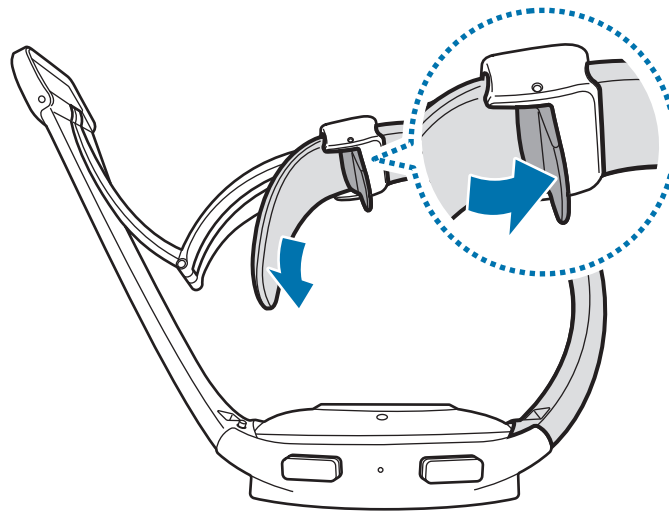

3 Place your Watch around your wrist and secure the buckle.

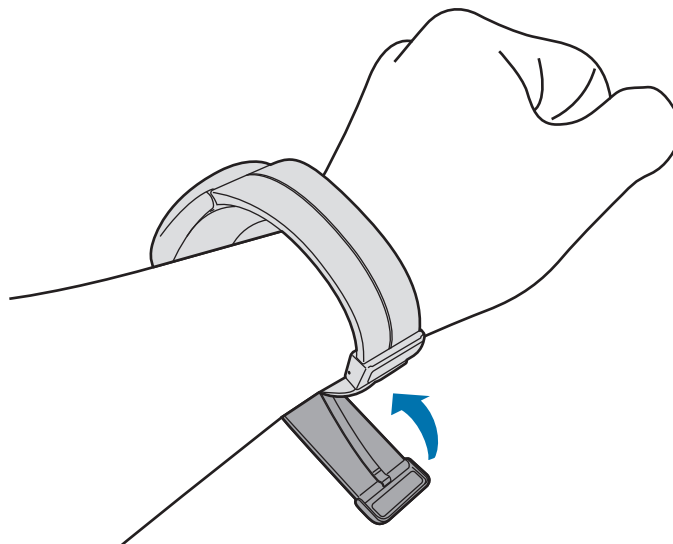

► **When connecting other bands:**

Open the buckle and place your Watch around your wrist. Fit the band to your wrist, insert the pin into an adjustment hole, and then secure the buckle to close it. If the band is too tight on your wrist, use the hole one further out.

## Band tips and precautions

- For accurate measurement, you have to wear the Watch so that it fits your wrist. After measuring, loosen the band to allow air to reach your skin. It is recommended to wear the Watch so that it is not too loose or tight, and that it feels comfortable in normal circumstances.
- When you wear the Watch for a long time or do a high-intensity exercise while wearing it, skin irritation may occur due to certain factors, such as friction, pressure, or moisture. If you have been wearing your Watch for a long time, remove it from your wrist for a while to keep your skin healthy and allow your wrist to rest.
- Skin irritation may occur due to an allergy, environment factors, other factors, or when your skin is exposed to soap or sweat for long periods. In this case, stop using your Watch immediately and wait 2 or 3 days for the symptoms to ease. If the symptoms persist or worsen, call your doctor.
- Make sure your skin is dry before wearing your Watch. If you wear a wet Watch for a long time, your skin may be affected.
- If you use your Watch in the water, remove foreign materials from your skin and Watch and dry them thoroughly to prevent the skin irritation.
- Do not use any accessories except the Watch in the water.

## How to wear the Watch for accurate measurements

For accurate measurements, wear the Watch firmly around your lower arm above the wrist while leaving a finger's worth of space as shown in the figure below.

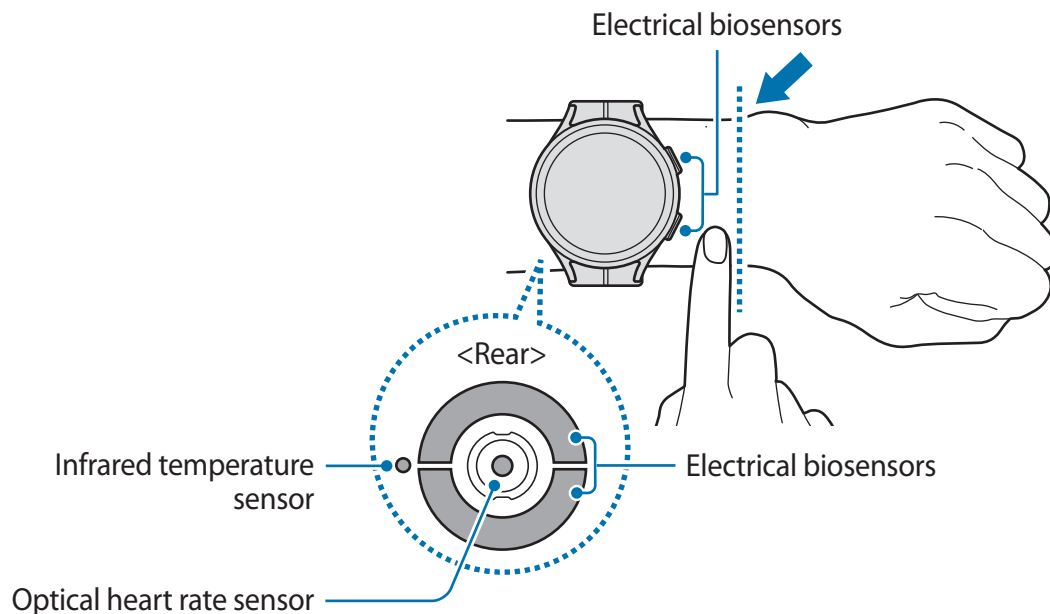

- If you fasten the Watch too tightly, the skin irritation may occur and if you fasten it too loosely, friction may occur.
- Do not look directly at the optical heart rate sensor's lights. Make sure children do not look directly at the lights. Doing so may impair your vision.
- If the Watch becomes hot to the touch, remove it until it cools. Exposing your skin to a hot surface of the Watch for a long time may cause low-temperature burns.
- Remove all water from your Watch and the band before measuring your body composition and ECG.
- If any water, dust, or stains are on the infrared temperature sensor, the measurements may be inaccurate.
- Clean the infrared temperature sensor with a soft cloth or cotton bud.



- Use the HR feature only for measuring your heart rate. The accuracy of the optical heart rate sensor may be diminished depending on measurement conditions and surroundings.
- Cold ambient temperatures may affect your measurement; during winter or cold weather, keep yourself warm when checking your heart rate.
- Smoking or consuming alcohol before taking measurements may cause your heart rate to be different from your normal heart rate.
- Do not move, talk, yawn, or breathe deeply while taking heart rate measurements. Doing so may cause your heart rate to be recorded inaccurately.
- If your heart rate is extremely high or low, measurements may be inaccurate.
- If measuring children's heart rates, the measurement may not be accurate.
- Users with thin wrists may receive inaccurate heart rate measurements when the device is loose, causing the light to be reflected unevenly. In this case, wear the Watch on your inner arm.
- If heart rate measurement is not working properly, adjust the position of the Watch's optical heart rate sensor to the right, left, up, or down on your wrist, or wear the Watch on your inner arm so that the sensor is in contact with your skin.
- If the optical heart rate sensor and the electrical biosensors are dirty, wipe the sensors and try again. If foreign materials prevent the light from reflecting evenly, the measurement may not be accurate.
- The optical heart rate sensor may be affected by tattoos, marks, and hair on the wrist you wear your Watch on. These may cause your Watch not to recognize that you are wearing it, and the Watch's features may not work properly. Therefore, wear your Watch on a wrist that does not interfere with the Watch's features.
- The measurement features may not work properly due to certain factors, such as the light from the optical heart rate sensor being blocked, depending on your skin brightness, blood flow under your skin, and the cleanliness of the sensor area.
- For accurate measurements, use the Ridge sport band. The Ridge sport band may be sold separately depending on the model.

## Turning the Watch on and off

- Follow all posted warnings and directions from authorised personnel in areas where the use of wireless devices is restricted, such as aeroplanes and hospitals.

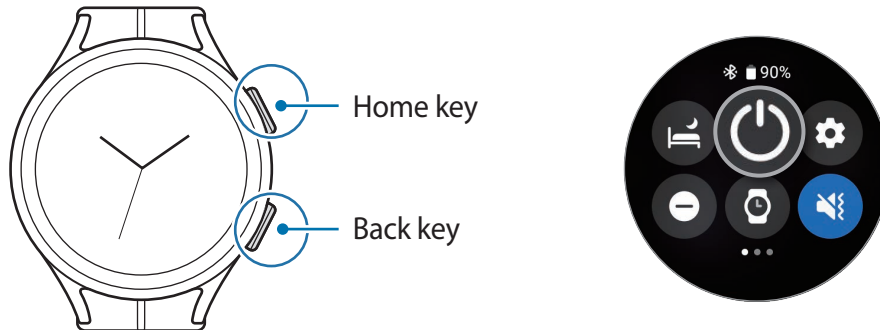



### Turning the Watch on

Press and hold the Home key for a few seconds to turn on the Watch.

When you turn on the Watch for the first time or reset it, on-screen instructions will appear to launch the Galaxy Wearable app on your smartphone. Refer to [Connecting the Watch to a smartphone](#) for more information.

### Turning the Watch off

- 1 Press and hold the Home key and the Back key simultaneously. Alternatively, open the quick panel by dragging downwards from the top edge of the screen and tap .
- 2 Tap **Power off**.

- You can set the Watch to turn off when you press and hold the Home key. On the Apps screen, tap  (**Settings**) → **Advanced features** → **Customise keys**, tap **Press and hold** under **Home key**, and then select **Power off menu**.

### Forcing restart

If your Watch is frozen and unresponsive, press and hold the Home key and the Back key simultaneously for more than 7 seconds to restart it.

## Connecting the Watch to a smartphone

### Installing the Galaxy Wearable app

To connect your Watch to a smartphone, install the Galaxy Wearable app on the smartphone. Depending on your smartphone, you can download the Galaxy Wearable app from the following places:

- Samsung Android smartphones: **Galaxy Store, Play Store**
- Other Android smartphones: **Play Store**



- It is compatible with Android smartphones that support Google mobile services.
- You cannot install the Galaxy Wearable app on the smartphones that do not support Watch syncing. Ensure that your smartphone is compatible with a Watch.
- The Watch cannot be connected to a tablet.

### Connecting the Watch to a smartphone via Bluetooth

- 1 Turn on the Watch.
- 2 Select a language to use and tap .
- 3 Select a country or region, and tap **Restart**.  
The Watch will turn off and then restart.
- 4 Swipe upwards from the bottom of the screen.  
On-screen instructions for launching the Galaxy Wearable app will appear.
- 5 Launch the **Galaxy Wearable** app on your smartphone.  
If necessary, update the Galaxy Wearable app to the latest version.
- 6 Tap **Start**.
- 7 Select your Watch on the screen.  
If you cannot find your device, tap **Mine's not here**.
- 8 Follow the on-screen instructions to complete the connection.  
When completing the connection, tap **START** and follow the on-screen instructions to learn about the Watch's basic controls.



- The initial setup screen may differ depending on your region.
- Connection methods may vary depending on your region, model, smartphone, and software version.
- The Watch is smaller than normal smartphones so the network quality may be lower, especially in areas with weak signals or poor reception. When a Bluetooth connection is unavailable, your cellular network or Internet connection may be poor or become disconnected.
- When you connect your Watch to a smartphone for the first time or after resetting it, the Watch's battery may drain more quickly while syncing data, such as contacts.
- Supported smartphones and features may vary depending on your region, service provider, or device manufacturer.
- When you cannot establish a Bluetooth connection between your Watch and the smartphone, the  indicator icon will appear on the top of the Watch screen.

## Connecting the Watch to a new smartphone

When you connect the Watch to a new smartphone, the Watch will reset all personal information. When the prompt appears before connecting your Watch to a new smartphone, tap **Back up data** to securely back up the stored data.

- 1 On the Apps screen, tap  (**Settings**) → **General** → **Connect to new phone** → **Continue**.

After a reset, it will automatically enter Bluetooth pairing mode.

- 2 On your new smartphone, launch the **Galaxy Wearable** app to connect to your Watch.

- If the smartphone you want to connect to is already connected to another device, launch the **Galaxy Wearable** app on your smartphone and tap  → **Add new device** to connect with a new device.

## Remote connection

Your Watch and smartphone are connected via Bluetooth. You can sync your smartphone to your Watch when both devices are remotely connected to each other, even though a Bluetooth connection is not available. The Remote connection uses your mobile network or Wi-Fi.

If this feature is not turned on, launch the **Galaxy Wearable** app on your smartphone, tap **Watch settings** → **Advanced features** → **Remote connection**, and then tap the switch to activate it.

## Controlling the screen

### Bezel

Your Watch has a touch bezel on the edges of the touchscreen. Swipe the bezel clockwise or anticlockwise to easily control various Watch functions.



- **Scrolling through screens:** Swipe the bezel to view other screens.
- **Moving from item to item:** Swipe the bezel to move from item to item.
- **Adjusting the input value:** Swipe the bezel to adjust the volume or brightness. When adjusting the brightness, swipe the bezel clockwise to make the screen brighter.
- **Using the phone or alarm feature:** Swipe the bezel clockwise to receive an incoming call or to dismiss an alarm. Swipe the bezel anticlockwise to reject an incoming call or to activate the snooze feature for an alarm.



If the bezel does not work, take it to a Samsung Service Centre or an authorised service centre without disassembling the Watch.

## Touchscreen

### Tapping

To open an app, to select a menu item, or to press an on-screen button, tap it with your finger.

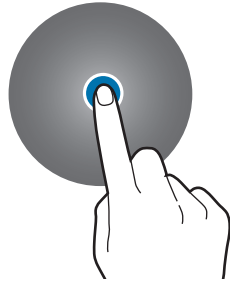

### Tapping and holding

Tap and hold the screen for two or more seconds to access the edit mode.

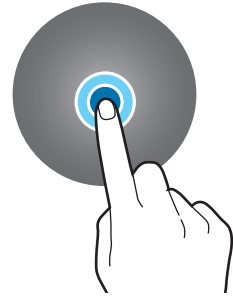

### Dragging

Tap and hold an item and drag it to the target position.

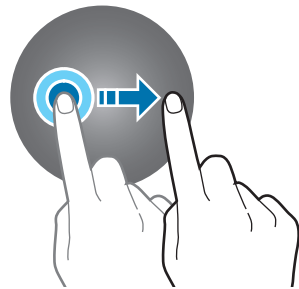

### Double-tapping

Double-tap quickly on an image to zoom in or out.



### Spreading and pinching

Spread two fingers apart or pinch on an image to zoom in or out.



### Swiping

Swipe to the left or right to view other panels.

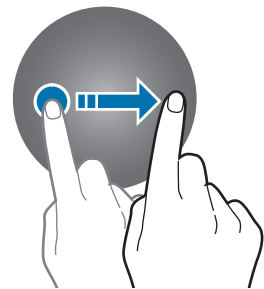



- ⚠ • Do not allow the touchscreen to come into contact with other electrical devices. Electrostatic discharges can cause the touchscreen to malfunction.
- To avoid damaging the touchscreen, do not tap it with anything sharp or apply excessive pressure to it with your fingertips.
- It is recommended not to use fixed graphics on part or all of the touchscreen for extended periods. Doing so may result in afterimages (screen burn-in) or ghosting.
- 📄 • The Watch may not recognise touch inputs close to the edges of the screen, which are outside of the touch input area.
- The touchscreen may not be available when water lock mode is activated.

## Screen composition

The Watch screen is the starting point of the Home screen, which is composed of several pages.

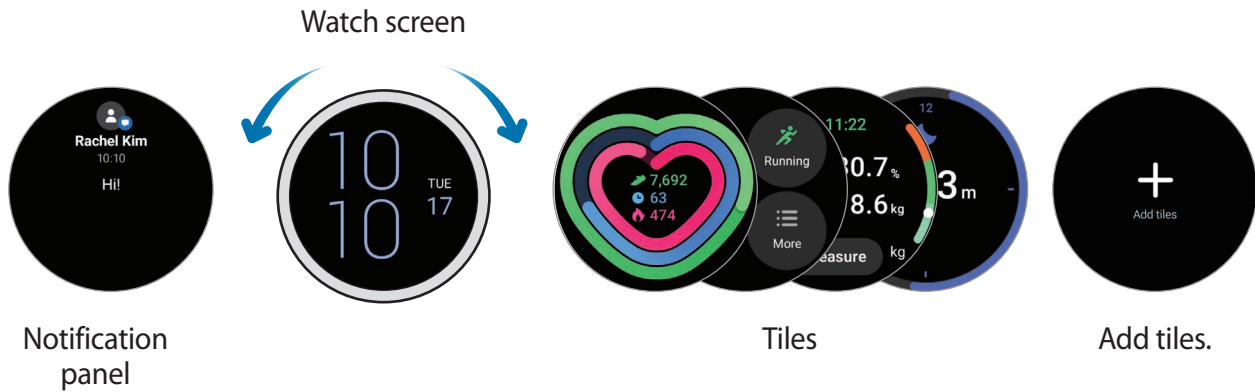
You can view tiles or open the notification panel by swiping the screen to the left or right or by using the bezel.



 The available panels, tiles, and their arrangement may vary depending on the software version.

## Using tiles

To add a tile, tap **Add tiles** and select a tile.

When tapping and holding a tile, you can access the edit mode to change the tile's arrangement or remove the tiles.

- **Moving the tile:** Tap and hold a tile to move and drag it to the desired location.
- **Removing the tile:** Tap  on the tile to delete.

## Turning the screen on and off

### Turning the screen on

Use the following methods to turn the screen on.

- **Turn the screen on with the keys:** Press the Home key or Back key.
- **Turn the screen on by raising your wrist:** Raise your wrist where you wear the Watch. If the screen does not turn on after you raise up your wrist, tap ⚙️ (**Settings**) on the Apps screen, tap **Display**, and then tap the **Raise wrist to wake** switch under **Screen wake-up** to activate it.
- **Turn the screen on by tapping the screen:** Tap the screen. If the screen does not turn on after you tap the screen, tap ⚙️ (**Settings**) on the Apps screen, tap **Display**, and then tap the **Touch screen to wake** switch under **Screen wake-up** to activate it.

### Turning the screen off

To turn off the screen, cover it with your palm. Also, the screen will automatically turn off if the Watch is not used for a specified period.

## Switching the screen

### Switching between the Watch and Apps screen

On the Watch screen, swipe upwards to open the Apps screen.

To return to the Watch screen, swipe downwards from the top of the Apps screen.

Alternatively, press the Home key or Back key.

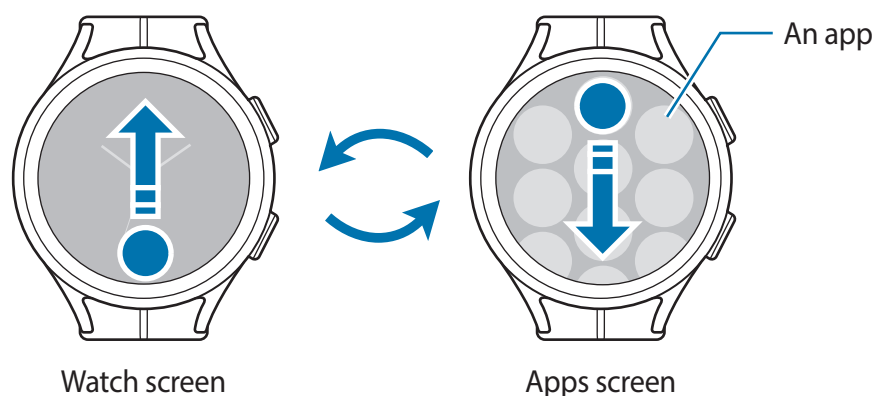

## Apps screen

The Apps screen displays icons for all apps installed on the Watch.

 The available apps may vary depending on the software version.

## Opening apps

On the Apps screen, tap an app icon to launch the app.

To launch an app from the list of recent apps, on the Apps screen, tap  (**Recent apps**).

## Closing apps

- 1 On the Apps screen, tap  (**Recent apps**).
- 2 Use the bezel or swipe left or right on the screen to move to the app to close.
- 3 Swipe upwards on the app to close it.

To close all running apps, tap **Close all**.

## Returning to the previous screen

To return to the previous screen, swipe right on the screen or press the Back key.

## Lock screen

Use the screen lock feature to protect your data, such as your personal information saved on your Watch. After activating this feature, the Watch will require you to unlock it whenever you use it. However, if you unlock it once while wearing the Watch, it will remain unlocked.

## Setting the screen lock

On the Apps screen, tap  (**Settings**) → **Security** → **Lock type** and select the lock method.

- **Pattern:** Draw a pattern with four or more dots to unlock the screen.
- **PIN:** Enter a PIN with numbers to unlock the screen.

# Watch

## Watch screen

You can check the current time or view other information. When you are not on the Watch screen, press the Home key to return to the Watch screen.

## Changing the watch face

- 1 Tap and hold the Watch screen and tap **Add watch face**.
- 2 Use the bezel or swipe left or right on the screen, and then select a watch face.  
If you tap **More watch faces**, you can download more watch faces from the Play Store app.
- 3 Tap **Customise** to customise the watch face. Swipe left or right on the screen to move to an item you want to customise, and then select the desired colour and other things by using the bezel or swiping upwards or downwards on the screen. To set the complications, tap each complication area you want.

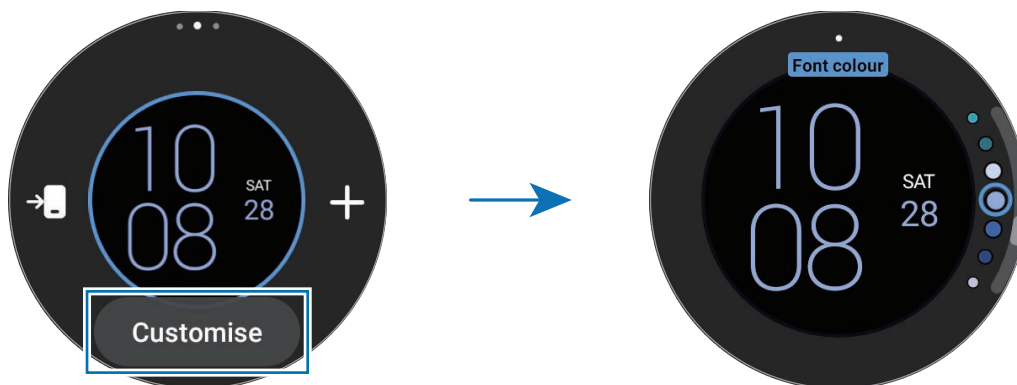

 You can also change the watch face and customise it from your smartphone. Launch the **Galaxy Wearable** app on your smartphone and tap **Watch faces**.

## Customising a watch face with a picture

Apply a picture as your watch face after importing a picture from your smartphone. Refer to [Importing images from your smartphone](#) for more information about importing pictures from a smartphone.

- 1 Tap and hold the Watch screen and tap **Add watch face**.
- 2 Tap **My Photo+**.

3 Tap **Customise**.

4 Tap the screen and tap **Add photo**.

5 Select a picture to apply as a watch face and tap **OK** → **OK**.

To zoom in or out on the picture, double-tap the image quickly, or spread two fingers apart or pinch the picture. When the picture is zoomed in, swipe the screen to make a part of the picture appear on the screen.





- To select several pictures at the same time, tap and hold a picture, select pictures by using the bezel or swiping left or right on the screen, and then tap .
- To add extra pictures after selecting pictures, tap **Add photo**.
- Up to twenty pictures can be added as the watch face. The pictures you add will appear when you tap the screen.

6 Swipe the screen to change the background and other items and return to the previous screen.

## Activating the Always On Display feature

Set the Watch screen and some apps' screens to always stay on while wearing your Watch. However, the battery will drain more quickly than normal while using this feature.

Open the quick panel by dragging downwards from the top edge of the screen and tap . Alternatively, on the Apps screen, tap  (**Settings**) → **Display** and tap the **Always On Display** switch to activate it.

## Activating watch only mode

In watch only mode, only the time will display and all other functions cannot be used.

On the Apps screen, tap  (**Settings**) → **Battery** → **Watch only** and tap **Turn on**.

To deactivate watch only mode, press and hold the Home key for more than three seconds. Alternatively, place the Watch on the wireless charger.



# Notifications

## Notification panel

Check a notification such as a new message or a missed call on the notification panel. On the Watch screen, swipe the bezel anticlockwise. Alternatively, swipe right on the screen to open the notification panel.

When there are new notifications, an orange notification indicator will be visible on the Watch screen. If the notification indicator does not appear, on the Apps screen, tap  (**Settings**) → **Notifications** and tap the **Notification indicator** switch to activate it.



## Viewing incoming notifications

When you receive a notification, information about the notification, such as its type or the time you received it, will appear on the screen. If more than two notifications are received, use the bezel or swipe left or right on the screen to view more notifications.

Tap the notification to view details.

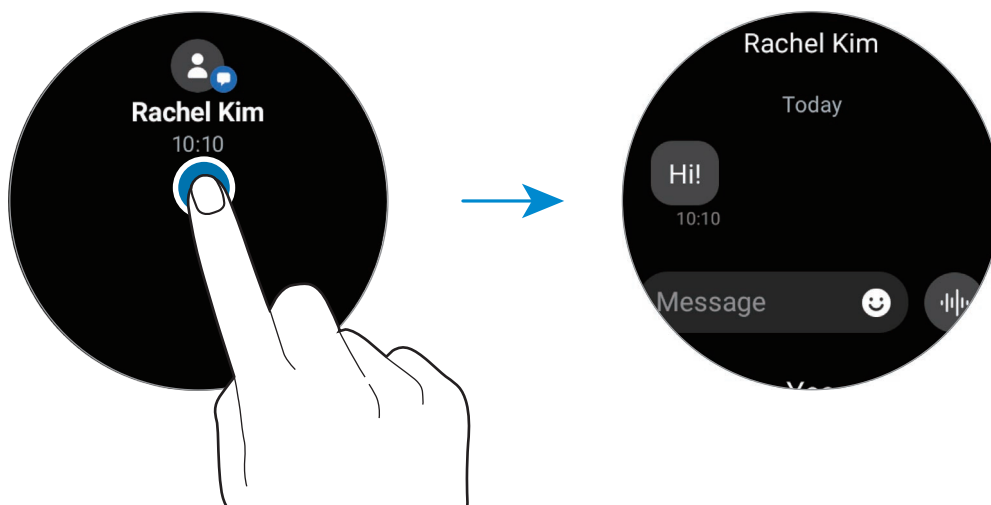

## Deleting notifications

Swipe upwards on the screen while viewing a notification.

## Selecting apps for receiving notifications

Select an app from your smartphone or Watch to receive notifications on your Watch.

- 1 Launch the **Galaxy Wearable** app on your smartphone and tap **Watch settings** → **Notifications**.
- 2 Tap **More** → ▼ → **All** and tap the switch next to apps to receive notifications from the apps list.

## Quick panel

This panel allows you to view the Watch's current status and configure settings.





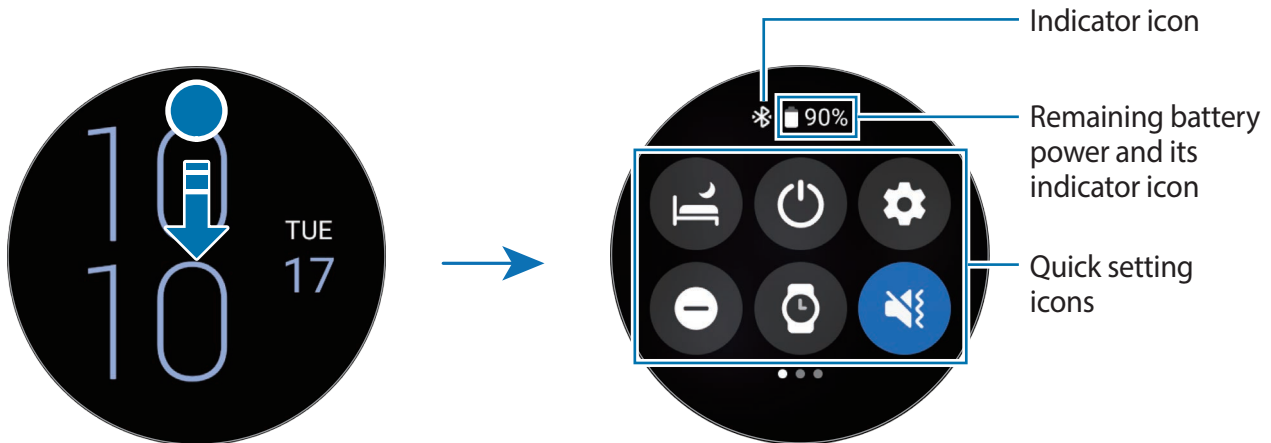

To open the quick panel, drag downwards from the top edge of the screen. To close the quick panel, swipe upwards on the screen.

Use the bezel or swipe left or right on the screen to move to the next or previous quick panel.



## Checking the indicator icons

Indicator icons appear at the top of the quick panel and let you know the Watch's current status. The icons listed in the table below are most common.









Icon	Meaning
	Bluetooth connected
	Signal strength
	LTE network connected
	Wi-Fi connected
	Watch and smartphone are remotely connected
	Battery power level













 The indicator icons may appear differently depending on the region, service provider, or model.

## Checking quick setting icons

Quick setting icons appear on the quick panel. Tap the icon to change the basic settings or launch the function conveniently. To view more detailed settings, tap and hold a quick setting icon.



Refer to [Editing a quick panel](#) for more information about adding or removing the quick setting icons on the quick panel.

Icon	Meaning
	Activate bedtime mode
	Access the power options
	Launch the <b>Settings</b> app
	Activate do not disturb mode
	Activate the Always On Display feature
	Activate sound, vibrate, or silent mode
	Activate the flash feature
	Adjust the brightness

Icon	Meaning
	Activate power saving mode
	Open the volume menu
	Connect the Wi-Fi network
	Activate water lock mode
	Activate flight mode
	Connect the Bluetooth headset
	Launch the <b>Find My Phone</b> app
	Activate the location information feature
	Activate theatre mode
	Connect the mobile network (SM-R905F, SM-R915F, SM-R925F)
	Activate the NFC feature
	Activate the touch sensitivity feature
	Connect to Bluetooth (SM-R905F, SM-R915F, SM-R925F)

## Editing a quick panel

Tap  to access the edit mode to change the quick setting icon's arrangement, or add or remove the quick setting icon.

- **Moving the quick setting icon:** Tap and hold a quick setting icon to move and drag it to the desired location.
- **Adding the quick setting icon:** Tap  on the quick setting icon to add.
- **Removing the quick setting icon:** Tap  on the quick setting icon to delete.

## Entering text

### Keyboard layout

A keyboard appears when you enter text.



- The text input screen may be different depending on the app you launch.
- Text entry is not supported in some languages. To enter text, you must change the input language to one of the supported languages.

### Changing the input language

Drag the — icon upwards, tap ⚙️ → **Input languages** → **Manage languages**, and then select the languages to use. When you select two languages, you can switch between the input languages by swiping to the left or right on the space key. You can add up to two languages.

- You can also set the input languages by tapping ⚙️ (**Settings**) on the Apps screen and tapping **General** → **Input** → **Samsung Keyboard** → **Input languages** → **Manage languages**.

### Changing the keyboard type

Drag the — icon upwards, tap ⚙️ → **Input languages**, select a language, and then select the keyboard type you want.

- On a 3 x 4 keyboard, a key has three or four characters. To enter a character, tap the corresponding key repeatedly until the desired character appears.

## Additional keyboard functions

Drag the  icon upwards to use additional keyboard functions.

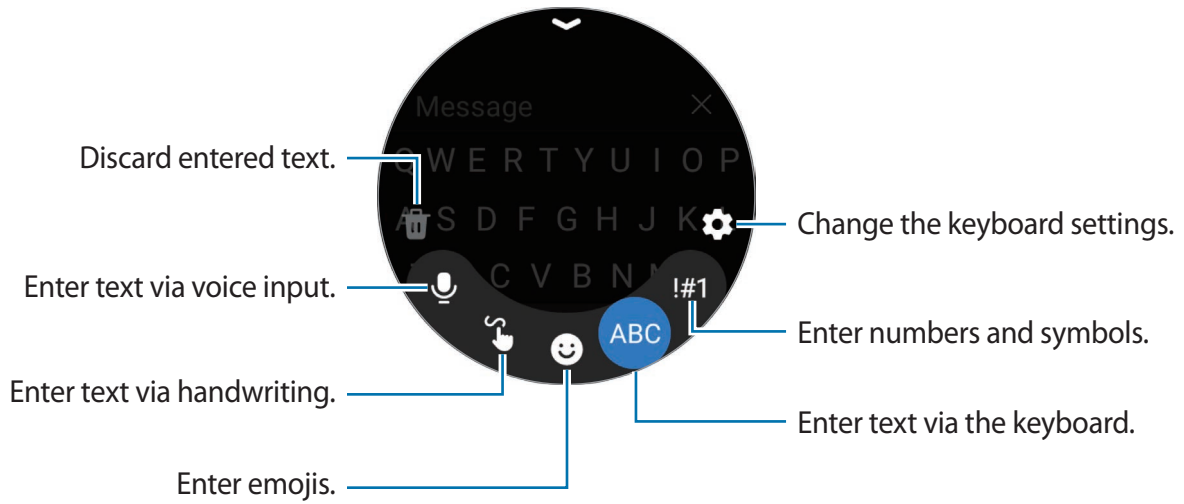



Some features may not be available depending on the language, service provider, or model.

# Apps and features

## Installing and managing apps

### Play Store

Purchase and download apps.

Tap  (**Play Store**) on the Apps screen. Browse apps by category or tap  and search for apps by keyword.

-  • Register the Google account on your Watch to use the Play Store app. Launch the **Galaxy Wearable** app on your smartphone, tap **Watch settings** → **Accounts and backup** → **Google account** → **Add Google account**, and then follow the on-screen instructions to copy the Google account from the smartphone to your Watch.
- To change the auto update settings, tap **Settings** and tap the **Auto-update apps** switch to activate or deactivate it.

### Managing apps

#### Uninstalling or disabling apps

Launch the **Galaxy Wearable** app on your smartphone, tap **Watch settings** → **Apps**, tap an app, and then select an option.

- **Uninstall:** Uninstall downloaded apps.
- **Disable:** Disable selected default apps that cannot be uninstalled from the Watch.

 Some apps may not support this feature.

#### Enabling apps

Launch the **Galaxy Wearable** app on your smartphone, tap **Watch settings** → **Apps**, select , and then tap **Disabled**. Select an app and tap **Turn on**.

## Setting app permissions

For some apps to operate properly, they may need permission to access or use information on your Watch.

To view or change app permission settings by permission category, on the Apps screen, tap  (Settings) → Privacy → Permission manager. Select an item and select an app.

 If you do not grant permissions to apps, the basic features of the apps may not function properly.

## Messages

View messages and reply to using the Watch.

You may incur additional charges for sending or receiving messages when you are roaming.

 The Android Messages app may be available depending on the region, and the settings for the default messages app are synced with the connected smartphone.

### Viewing messages

1 Tap  (Messages) on the Apps screen.

Or, open the notification panel and view a new message.

2 Scroll through the message list or use the bezel, and then select a contact to view your conversations.

To view a message on your smartphone, tap **Show on phone**.





To reply a message, tap the message input field and enter a message.

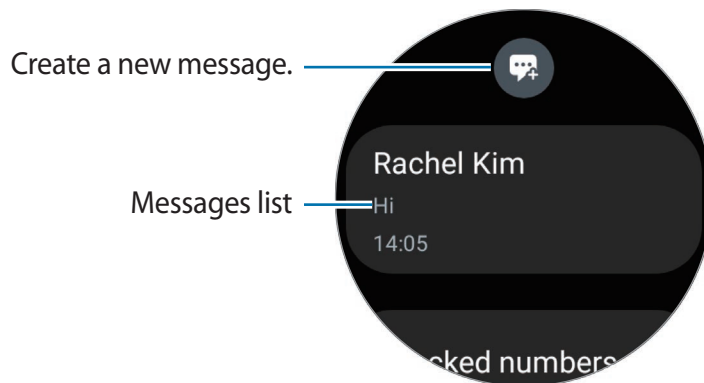

## Sending messages

- 1 Tap  (Messages) on the Apps screen.



- 2 Tap .
- 3 Tap **Recipient** or tap  to enter a message recipient or phone number. Or, tap  and select a message recipient from the contacts list.
- 4 Tap the message input field and enter a message or select a text template, and then tap  or .

## Recording and sending a voice message

You can send a voice file after recording what you want to say.

On the message input screen, tap  and say what you want to be sent.

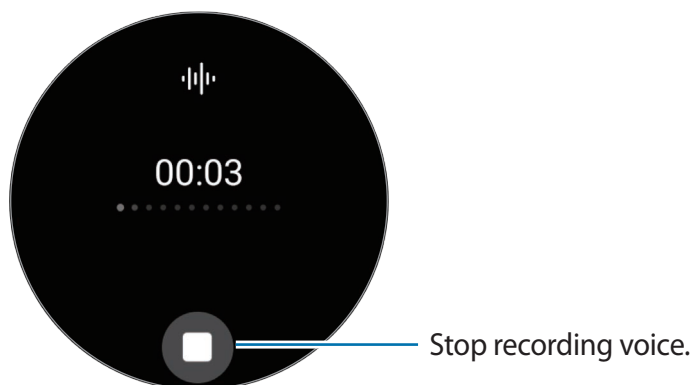

## Deleting messages

- 1 Tap  (**Messages**) on the Apps screen.
- 2 Scroll through the message list or use the bezel, and then select a contact to view your conversations.
- 3 Tap and hold a message, then tap **Delete**.  
To delete multiple messages, tap and hold a message, select messages you want to delete, and then tap **Delete**.  
The message will be deleted both from the Watch and the connected smartphone.

## Phone

### Introduction

You can make calls and check incoming calls and receive them.



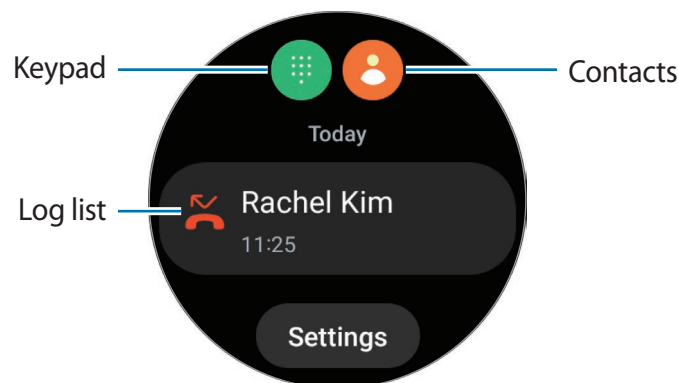

-  The sound may not be heard clearly during a call and only brief calls are available in areas with weak signals.

### Making calls

Tap  (**Phone**) on the Apps screen.







Use one of the following methods to make calls.



- Tap , enter a number using the keypad, and then tap .
- Tap , use the bezel or scroll through the contact list, select a contact, and then tap .
- Use the bezel or scroll through the log list, select a log entry, and then tap .

## Selecting the number to use for making calls (SM-R905F, SM-R915F, SM-R925F)

You can select the number you want to use between the Watch's number and the connected smartphone's number when making calls. Also, if your Watch is connected to a smartphone that supports dual SIM cards, you can select a SIM card to make calls.

- 1 Tap  (**Phone**) on the Apps screen.
  - 2 Tap .
  - 3 Tap  and select the option you want.
    - **Phone:** Make calls with the number of connected smartphone.
    - **SIM 1:** Make calls with the number of the connected smartphone's SIM card 1.
    - **SIM 2:** Make calls with the number of the connected smartphone's SIM card 2.
    - **Watch:** Make calls with the Watch's number.
-  • Some features may not be available depending on the connected smartphone.
- You can also select a number to use by tapping and holding the call button after selecting a log entry.

## Setting a preferred number in advance (SM-R905F, SM-R915F, SM-R925F)

- 1 Tap  (**Phone**) on the Apps screen.
  - 2 Tap **Settings**.
  - 3 Tap **Preferred number** and select the option you want.
    - **Phone:** Set to make calls with the number of connected smartphone.
    - **Watch:** Set to make calls with the Watch's number.
    - **Always ask:** Set to always ask which number to use whenever making calls.
-  When the connected smartphone supports dual SIM cards, you can select the smartphone's SIM card you want to use. On the Apps screen, tap  (**Settings**) → **Connections** → **SIM card manager** and select a SIM card for making calls under **Preferred SIM for calls**. If you do not select the SIM card, you have to select a SIM card to use when you make calls.

## Options during calls

The following actions are available:

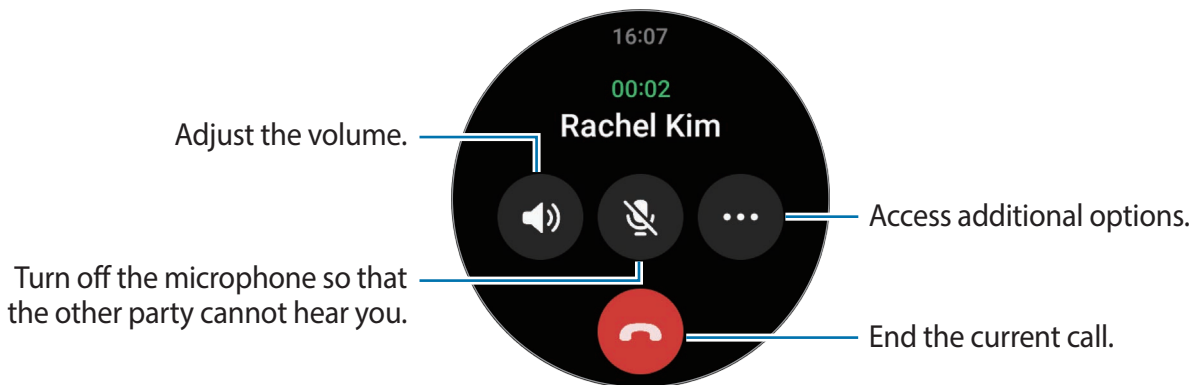

 The screen's appearance may differ depending on the model.

## Making a phone call with a Bluetooth headset

When a Bluetooth headset is connected, you can make phone calls with it.

While the Bluetooth headset is not connected, on the Apps screen, tap  (**Settings**) → **Connections** → **Bluetooth**. When the available Bluetooth devices list appears, select a Bluetooth headset you want to use.

## Receiving calls

### Answering a call

When a call comes in, swipe the bezel clockwise. Alternatively, drag  outside the large circle.

You can have phone conversations via the Watch's internal microphone, speaker, or a connected Bluetooth headset.

### Rejecting a call

You can reject incoming calls and send a rejection message to the caller.

When a call comes in, swipe the bezel anticlockwise. Alternatively, drag  outside the large circle.

To send a message when rejecting an incoming call, drag the  icon upwards and select the message you want.

## Missed calls

If a call is missed, a missed call notification is displayed on the notification panel. On the notification panel, view missed call notifications. Alternatively, tap  (**Phone**) on the Apps screen to view missed calls.

## Contacts

You can make a call or send a message to a contact. The contacts saved on your connected smartphone will be also saved to your Watch.



Tap  (**Contacts**) on the Apps screen.

 The favourites list contacts on the smartphone will display on the top of the contacts list.

Use one of the following search methods:

- Tap  and enter the search criteria on the top of the contacts list.
- Scroll through the contacts list.
- Use the bezel. When you swipe the bezel quickly, the list scrolls by the alphabet of the first letter.

Once a contact is selected, take one of the following actions:

-  : Make a voice call.
-  : Compose a message.

## Selecting the frequently used contacts on the tile

Add the frequently used contacts from the **Contacts** tile to contact them directly via text message or phone call. Tap **Add** →  and select contact.

-  • To use this feature, you must add the **Contacts** tile. Refer to [Using tiles](#) for more information.
- Up to four contacts can be added on the tile.

## Samsung Pay

Register cards to Samsung Pay to make payments quickly and securely.

You can view more information, such as cards that support this feature at [www.samsung.com/samsung-pay](http://www.samsung.com/samsung-pay).

- To make payments with Samsung Pay, the device may be required a connection to a Wi-Fi or mobile network depending on the region.
- This feature may not be available depending on the service provider or model.
- The procedures for the initial setup and card registration may vary depending on the region or service provider.

### Setting up Samsung Pay

- 1 On your smartphone, launch the **Galaxy Wearable** app.
- 2 Tap **Watch settings** → **Apps** → **App settings** → **Samsung Pay** and follow the on-screen instruction to complete your card registration.

### Making payments

- 1 To make a payment on your Watch, press and hold the Back key on the Watch screen or on the Samsung Pay intro page.
- 2 Enter your PIN or draw the pattern you set.
- 3 Scroll through the cards list, select a card and tap **PAY**.
- 4 Place your Watch close to the card reader.  
When the card reader recognises the card information, the payment will be processed.



- Payments may not be processed depending on your network connection.
- The verification method for payments may vary depending on the card readers.

# Samsung Health

## Introduction

Samsung Health records and manages your 24-hour activity and sleep pattern to cultivate a healthy habit. You can save and manage health-related data on the Samsung Health app of the connected smartphone.

After continuously exercising for more than 10 minutes (for running, 3 minutes) while wearing the Watch, the auto detect workouts feature will be activated. Also the Watch will notify you and show you some stretching motions to follow or it will show you a screen encouraging you to engage in light activity when the Watch recognises inactivity for more than 50 minutes. When your Watch recognises that you are driving or sleeping, it may not notify you and not display a stretching screen although you are physically inactive.

Visit [www.samsung.com/samsung-health](http://www.samsung.com/samsung-health) for more information.

 Samsung Health features are intended only for leisure, well-being, and fitness purposes. They are not intended for medical use. Before using these features, read the instructions carefully.

## Daily activity

Check your current daily status, such as steps, active times, activity calories, and their targets, and related information.

### Checking your daily activity

Tap  (Samsung Health) on the Apps screen and tap **Daily activity**.

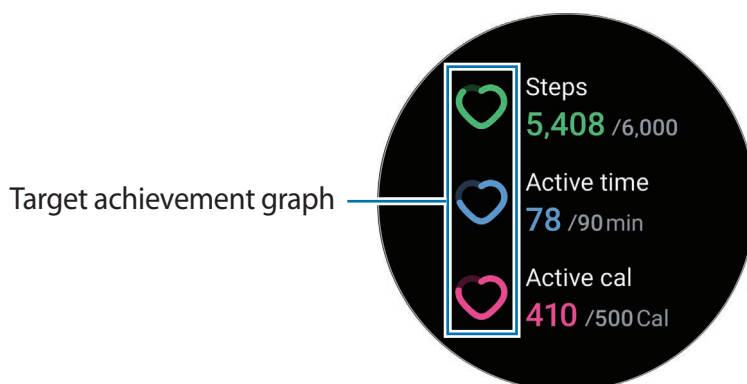

- **Steps:** Check the amount of steps you walk throughout the day. As you approach your step target, the graph will increase.
- **Active time:** Check the total time you were physically active throughout the day. As you approach your active time target by doing light activities, such as stretching, or walking, the graph will increase.
- **Activity cal:** Check the total amount of calories you spent doing an activity throughout the day. As you approach your activity calories target, the graph will increase.

To view additional information which is related to your daily activity, use the bezel or swipe upwards or downwards on the screen.

## Setting the daily activity target

- 1 Tap  (Samsung Health) on the Apps screen.
- 2 Tap **Daily activity** and tap **Set targets**.
- 3 Select an activity option.
- 4 Use the bezel or swipe upwards or downwards on the screen to set the target.
- 5 Tap **Done**.

## Steps

The Watch counts the number of steps you have taken.

## Measuring your step count

Tap  (Samsung Health) on the Apps screen and tap **Steps**.

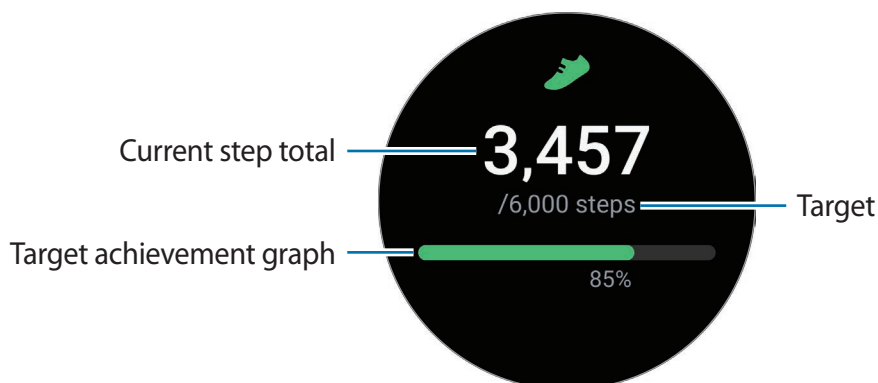

To view additional information which is related to the steps, use the bezel or swipe upwards or downwards on the screen.





- When you start to measure your step, the step tracker monitors your steps and displays your step count after a brief delay because your Watch accurately recognises your movement after you walk for a while. Also, for an accurate step count, you may experience a brief delay before the notification indicates that a certain goal has been reached.
- If you use the steps tracker while travelling by car or train, vibration may affect your step count.
- One floor is calculated as approximately 3 metres. The floors measured may not match the actual floors you climb.
- The floors measured may not be accurate depending on the environment, the user's movements, and the conditions of buildings.
- The floors measured may not be accurate if water (shower and water activity) or foreign materials enter the atmospheric pressure sensor. If there is any detergent, sweat, or raindrops on the Watch, rinse it with clean water and dry the atmospheric pressure sensor thoroughly before use.

### Setting the step target

- 1 Tap  (Samsung Health) on the Apps screen.
- 2 Tap **Steps** and tap **Set target**.
- 3 Use the bezel or swipe upwards or downwards on the screen to set the target.
- 4 Tap **Done**.

## Exercise

Record your exercise information and check the results.





- Before using this feature, pregnant women, the elderly, and young children, users suffering from conditions, such as chronic heart disease or high blood pressure, are recommended to seek the advice of a licensed medical professional.
- If you feel dizzy, experience pain, or have difficulty breathing during exercise, stop exercising immediately and seek the advice of a licensed medical professional.
- Your heart rate is measured when you start exercising. For accurate measurements, wear the Watch firmly around your lower arm above the wrist. Refer to [How to wear the Watch for accurate measurements](#) for more information.
- Do not move until your heart rate displays on the screen so it can be measured more accurately.
- Your heart rate may not be visible temporarily due to various conditions such as the environment, your physical state, or how the Watch is worn.

### **Be aware of following conditions before exercising in cold weather conditions:**

- Avoid using the device in cold weather. If possible, use the device indoors.
- If you use the device outside in cold weather, cover the Watch with your sleeves before using it.

## Starting exercises

- 1 Tap  (Samsung Health) on the Apps screen.
- 2 Tap **Exercise** → **Choose workout**.
  -  You can start exercising directly from the **Multi-workouts** tile after adding workouts to it.
- 3 Use the bezel or swipe left or right on the screen to select an exercise type you want and begin.  
When there is no exercise type you want, tap **Add**, and then select an exercise type you want.

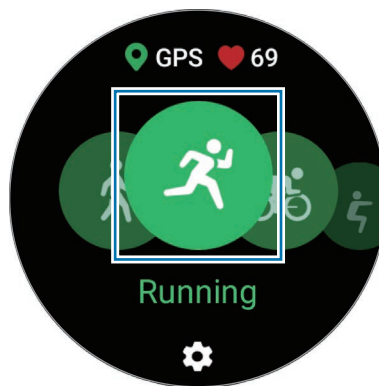

- 4 Use the bezel or swipe upwards or downwards on the screen to view exercise information, such as your heart rate, distance, or time, on the workout screen.

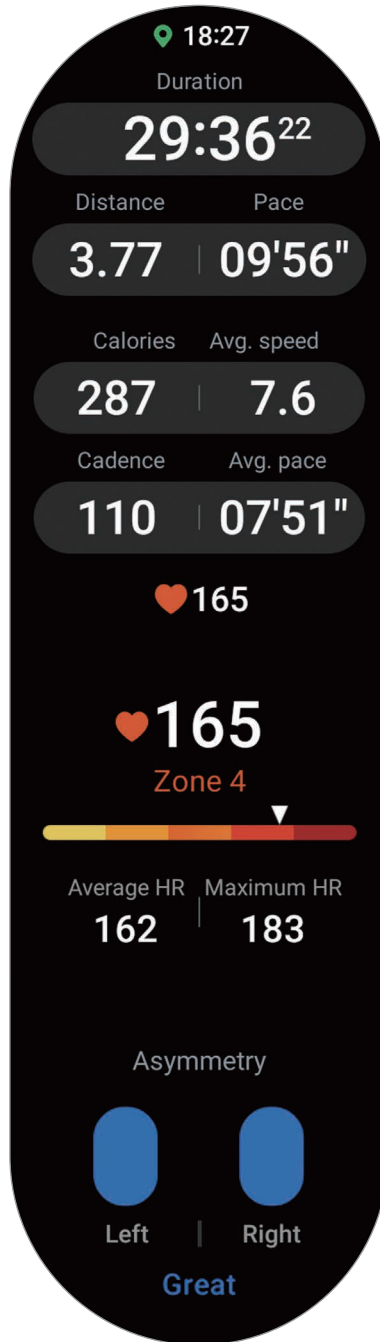

You can play music by swiping left on the screen.

-  • When you select **Swimming** or **Swimming (outdoor)**, water lock mode will be automatically activated and the touchscreen will be disabled.
- When you select **Swimming** or **Swimming (outdoor)**, the recorded value may not be accurate in following cases:
  - If you stop swimming before reaching the completion point
  - If you change your swimming stroke midstream
  - If you stop moving your arms before reaching the completion point
  - If you kick with your legs on a kickboard or swim without moving your arms
  - If you swim with only one arm
  - If you swim under water
  - If you do not pause or restart the exercise, but finish the exercise while resting

5 Swipe right on the screen and tap **Finish**.

To pause or restart the exercise, swipe right on the screen and tap **Pause** or **Resume**.  
Alternatively, press and hold the Back key.

-  • To finish swimming, first press and hold the Home key to deactivate water lock mode, shake your Watch to completely remove any water from it to ensure that the atmospheric pressure sensor will work properly, and then tap **OK**.
- Music will continue to play even if you finish exercising. To stop playing music, stop music before finishing exercising or launch the **Music** app or **Media Controller** app to stop playing music.

6 Use the bezel or swipe upwards or downwards on the screen after finishing the exercise and view your exercise results.

### Doing multiple exercises

You can log various exercises and go straight through an entire routine by starting another exercise right after finishing the current exercise.

Swipe right on the screen while working out, tap **New**, and then select the next exercise type to begin.

-  To finish swimming, first press and hold the Home key to deactivate water lock mode, shake your Watch to completely remove any water from it to ensure that the atmospheric pressure sensor will work properly, and then tap **OK**.

## Starting repetitive exercises

When you perform repetitive exercises such as squats or deadlifts, your Watch will count how many times you repeat the motion with beeping.

- 1 Tap  (**Samsung Health**) on the Apps screen.
- 2 Tap **Exercise** → **Choose workout**.
- 3 Use the bezel or swipe left or right on the screen to select a type of repetitive exercise you want and begin.

When there is no repetitive exercise type you want, tap **Add**, and then select an exercise type you want.

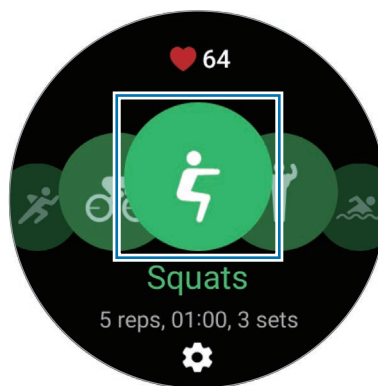

- 4 Tap **OK** and get into the proper position to start by following the pose on the screen.

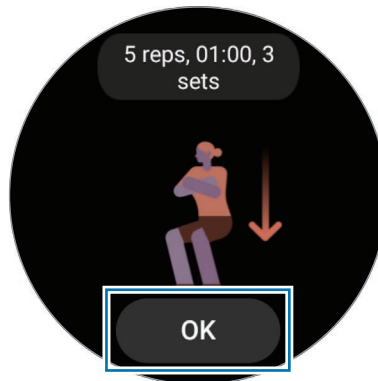

Counting will begin with beeping.

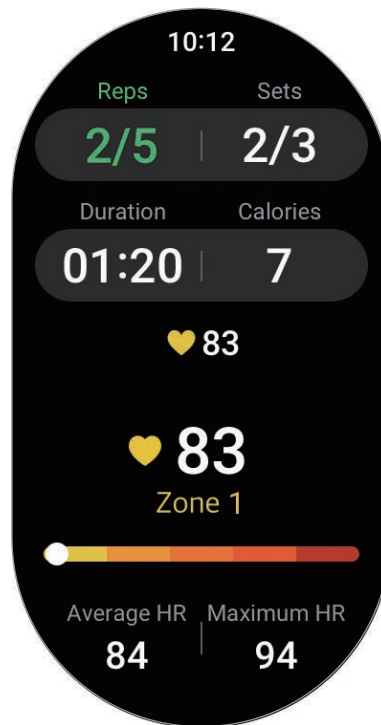

- 5 Use the bezel or swipe upwards or downwards on the screen to view exercise information, such as your heart rate, the number of repetition, or calories, on the workout screen.



You can play music by swiping left on the screen.

- 6 Take a minute's rest after completing a set. Or, tap **Skip** if you want to skip to the next set without resting. The exercise will begin after you get into the proper position to start it by following the pose on the screen.
- 7 Swipe right on the screen and tap **Finish**.  
To pause or restart the exercise, swipe right on the screen and tap **Pause** or **Resume**.  
Alternatively, press and hold the Back key.
  - 📌 Music will continue to play even if you finish exercising. To stop playing music, stop music before finishing exercising or launch the **Music** app or **Media Controller** app to stop playing music.
- 8 Use the bezel or swipe upwards or downwards on the screen after finishing the exercise and view your exercise results.

## Setting the exercise

- 1 Tap  (Samsung Health) on the Apps screen.
  - 2 Tap **Exercise** → **Choose workout**.
  - 3 Tap  under each exercise type and set the various exercise options.
    - **Pool length:** Set the pool length.
    - **Target:** Activate the exercise target feature and set it.
    - **Track back:** Set to receive navigation guidance to go back to the start point when you hike or cycle. (SM-R920, SM-R925F)
    - **Workout screen:** Set the screens that appear while you are working out.
    - **Coaching messages:** Set to receive coaching messages for proper pacing while working out.
    - **Guide frequency:** Set to receive guidance whenever you reach the distance or time you set.
    - **Auto lap:** Set to record the lap time manually by tapping the screen twice quickly or automatically at the distance or time you set while working out.
    - **Auto pause:** Set the Watch's exercise feature to pause automatically when you stop working out.
    - **Audio guide:** Turn the audio guide on or off.
-  You can also change certain settings while exercising. While working out, swipe right on the screen and tap **Settings**.



## Auto detect workouts feature

Once you have engaged in an activity for more than 10 minutes (for running, 3 minutes) while wearing the Watch, it automatically recognises that you are exercising and records exercise information such as the exercise type, duration and calories burned.

When you stop doing some exercises for more than one minute, the Watch automatically recognises that you have stopped exercising and recording will end.



- You can check the list of exercises which are supported by the auto detect workouts feature. On the Apps screen, tap  (Samsung Health) and tap **Settings** → **Activities to detect**. If the exercises are not recognised automatically, turn on the auto detect workouts feature and tap the switch of the exercise type that uses this feature.
- The auto detect workouts feature measures something, such as the time you spent exercising and calories burnt by using the acceleration sensor. The measurements may not be accurate depending on your manner of walking, exercise routines, and lifestyle.
- If you are walking or running, the Watch may provide the feature that allows you to switch to manual exercise after they are automatically recognised. If you want to record in detail, including the course you are working out, switch to manual exercise. In this case, you must finish the Watch's exercise feature manually when finishing the exercise.

## Food

Record the calories you eat in a day and compare with your target calories to get help to manage your weight.

### Recording the calories

- 1 Tap  (Samsung Health) on the Apps screen.
- 2 Tap **Food**.
- 3 Tap **Add**, tap the meal type on the top of the screen, and then select an option.
- 4 Use the bezel or swipe upwards or downwards on the screen to set the caloric intake, and then tap **Done**.

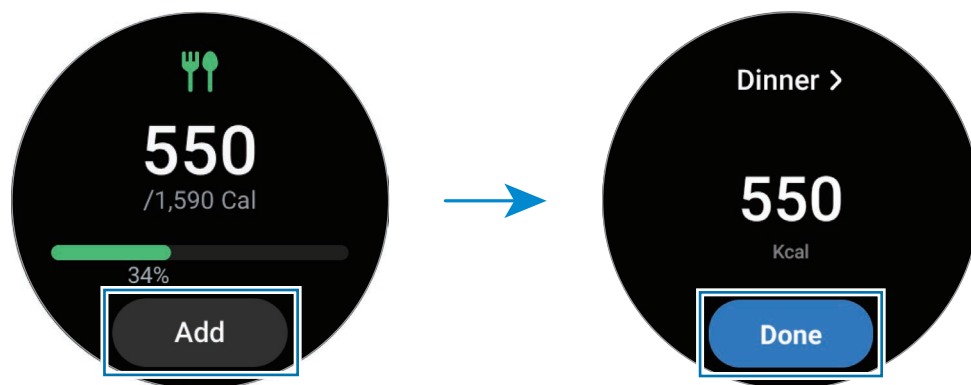

To view additional information which is related to the caloric intake, use the bezel or swipe upwards or downwards on the screen.

### Deleting logs

- 1 Tap  (Samsung Health) on the Apps screen.
- 2 Tap **Food** and tap **Delete today's log**.
- 3 Select data to delete and tap **Delete**.

### Setting your caloric intake target

- 1 Tap  (Samsung Health) on the Apps screen.
- 2 Tap **Food** and tap **Set target**.
- 3 Use the bezel or swipe upwards or downwards on the screen to set the target.
- 4 Tap **Done**.

## Sleep

Analyse your sleep and record it by measuring your heart rate and your movement while you are sleeping.



This feature is only for your general wellness and fitness. Therefore, do not use it for medical purposes, such as diagnosing the symptoms, treatment, or prevention of disease.



- The sleep pattern will have its four states (Awake, REM, Light, Deep) analysed by using your movement and changes in your heart rate while you are sleeping. A graph will be provided with recommended ranges for each measured sleep state.
- If your heart rate is irregular or your Watch cannot recognise your heart rate properly, the sleep pattern will be analysed into three states (Restless, Light, Motionless).
- You can check the detailed sleep analysis only when your Watch is connected to your smartphone.
- Before measuring, charge the Watch's battery so it is more than 30%.
- For accurate measurements, wear the Watch firmly around your lower arm above the wrist. Refer to [How to wear the Watch for accurate measurements](#) for more information.

## Measuring your sleep

1 Sleep while wearing the Watch.

The Watch will start to measure your sleep.

2 Tap  (Samsung Health) on the Apps screen after you wake up.

3 Tap **Sleep**.

- 4 Use the bezel or swipe upwards or downwards on the screen to view all information related to your measured sleep.

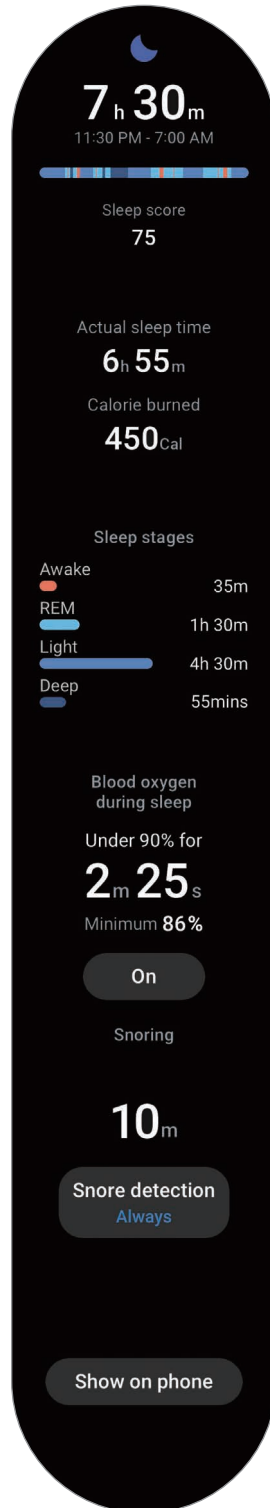

## Using the snore detection feature

- 1 Tap  (Samsung Health) on the Apps screen.
- 2 Tap **Settings**.
- 3 Tap **Snore detection** and activate the feature by following the on-screen instructions. Your snoring will be measured along with your other sleep records when you sleep while wearing the Watch.



- The snore detection feature can be activated on the Samsung Health app (version 6.18 or higher) of the connected smartphone. Also, you must place the connected smartphone's microphone so it faces you.
- To always detect your snoring whenever you are sleeping, after setting the snore detection feature to **Always**, connect your smartphone to the charger before sleeping. If not, snoring may not be measured.

## Body composition

Measure your body composition, such as your skeletal muscle mass or fat mass.



- This feature is only for your general wellness and fitness. Therefore, do not use it for medical purposes, such as diagnosing the symptoms, treatment, or prevention of disease.
- Do not measure your body composition if you have an implanted cardiac pacemaker, defibrillator, or if any other electronic device is inside of your body.
- A low electric current goes through your body when measuring your body composition. Although it is harmless to humans, do not measure your body composition if you are pregnant.



- For accurate measurements, wear the Watch firmly around your lower arm above the wrist. Refer to [How to wear the Watch for accurate measurements](#) for more information.
- If the measured body composition results are inaccurate, check your user profile in the Samsung Health app on the smartphone and modify it.
- Unlike professional body composition measuring instruments, the Watch, which has to be worn your wrist, measures the upper body's composition and estimates your entire body's composition to provide the results. Therefore the measured body composition results may be inaccurate in the following cases: when your upper and lower body's composition is too unbalanced, when you are extremely obese, or when you have a very large amount of muscles.



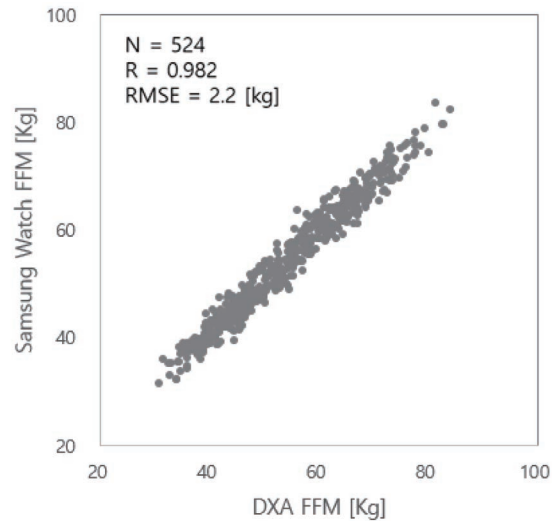

- The Watch uses the Bioelectrical Impedance Analysis (BIA) method when measuring body composition, which has more than 98% correlation compared to the Dual-energy X-ray absorptiometry (DXA) method, which is regarded as the golden standard.



**Be aware of following conditions before measuring your body composition:**

- If you are an individual under the age of 20, the results may not be accurate when you measure your body composition.
- You can get more accurate body composition results if you follow the following measurement conditions:
  - Measuring at the same time of the day (recommended to measure in the morning)
  - Measuring on an empty stomach
  - Measuring after going to the bathroom
  - Measuring when you are not having your menstrual period
  - Measuring before doing activities that cause your body temperature to rise, such as exercising, taking showers, or going to the sauna.
  - Measuring after removing metal objects from your body, such as necklace
  - Using the band included with the product instead of a metallic band

## Measuring your body composition

- 1 Tap  (Samsung Health) on the Apps screen.
- 2 Tap **Body composition**.
- 3 Tap **Measure**.
- 4 Enter your weight and tap **Confirm**.
  -  • For accurate body composition measurements, you must enter your actual height, weight, and gender on the Samsung Health app profile of the connected smartphone, and also enter the actual birthday on your Samsung account.
  - You can view how to measure your body composition in detail on the screen by tapping **How to measure**.
- 5 Place your two fingers on the Home and Back keys by following the on-screen instructions to begin measuring your body composition.

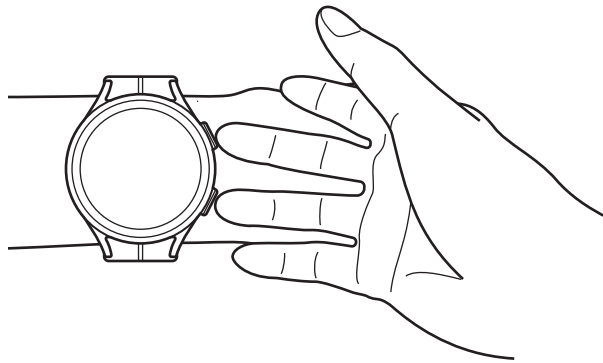

Correct posture for measuring your body composition when wearing the Watch on your left wrist

### **Correct measurement posture**

- Put both of your arms to chest level while not making contact with your body.
- Do not allow the two fingers that are placed on the Home and Back keys to come into contact with each other. Also do not touch the other part's of your Watch with your fingers except the keys.
- Stay stable and do not move for accurate measurement results.
- The signal may experience interruptions when your finger is dry. In this case, measure your body composition after applying toner or lotion to make your finger's skin moist.
- Measurement results may not be accurate due to the dryness of your skin or hair.
- Wipe the back of the Watch clean before measuring for accurate measurement results.

Check measured body composition results on the screen.

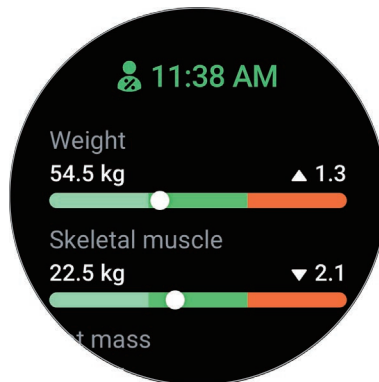

To view the additional information which is related to the body composition, use the bezel or swipe upwards or downwards on the screen.

## Women's health

Enter your menstrual period to begin tracking your cycle. When you are managing and tracking your menstrual cycle, you can predict date like your next period. Moreover, you can help manage your health by recording your symptoms and moods.

- ⚠️ • This feature is only for managing and tracking women's menstrual cycle. Therefore, do not use it for medical purposes, such as diagnosing the symptoms, treatment, or prevention of disease.
- This feature is not intended to be used for pregnancy planning or contraception purposes.
- Predicted dates are only for personal reference. Predicted dates may differ from actual dates.
- Individuals under the age of 18 should use this feature with a guardian.
- Do not make any medical decisions based on predicted dates without consulting a physician. Also, do not use the information provided from the Samsung Health app or take medical actions without consulting with a qualified medical expert.
- 📱 • Activate the women's health feature in the Samsung Health app on your smartphone to use this feature on your Watch.
- Predicted dates may not be accurate if you are currently taking birth control or undergoing hormone therapy to suppress ovulation.
- Predicted dates may vary depending on the input information.



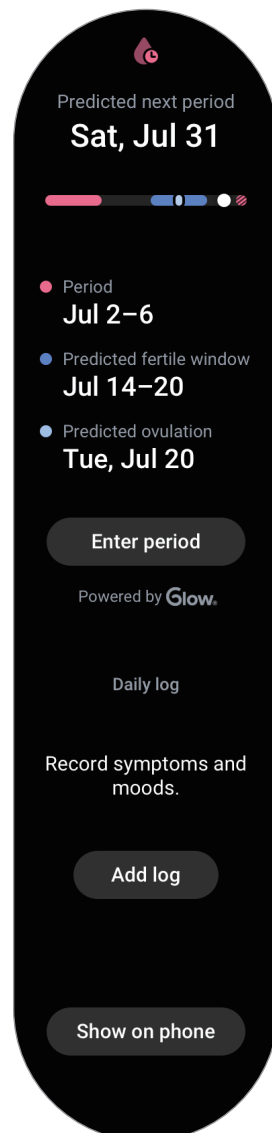

- 1 Tap  (Samsung Health) on the Apps screen.
- 2 Tap **Women's health**.
- 3 Tap **Enter period**.
- 4 Tap the input field, use the bezel or swipe upwards or downwards on the screen to set your period's start date.
- 5 Tap **Save**.
- 6 Use the bezel or swipe upwards or downwards on the screen to view all information related to your women's health.



Tap **Add log** and select additional information you wish to record, such as symptoms or moods.

## Heart rate

Measure and record your heart rate.

-  The Watch's heart rate tracker is intended for fitness and informational purposes only and is not intended for use in the diagnosis of disease or other conditions, or in the cure, mitigation, treatment, or prevention of disease.
-  For accurate measurements, wear the Watch firmly around your lower arm above the wrist. Refer to [How to wear the Watch for accurate measurements](#) for more information.

### **Be aware of following conditions before measuring your heart rate:**

- Rest for 5 minutes before taking measurements.
- If the measurement is very different from the expected heart rate, rest for 30 minutes and then measure it again.
- During winter or in cold weather, keep yourself warm when measuring your heart rate.
- Smoking or consuming alcohol before taking measurements increases heart rate and may cause your heart rate to be different from your normal heart rate.
- Do not talk, yawn, or breathe deeply while taking heart rate measurements. Doing so may cause your heart rate to be recorded inaccurately.
- Heart rate measurements may vary depending on the measurement method and the environment they are taken in.
- If the sensor is not working, check the Watch's position on your wrist and make sure nothing is obstructing the sensor. If the sensor continues to have the same problem, visit a Samsung Service Centre or an authorised service centre.

### **Measuring your heart rate manually**

- 1 Tap  (Samsung Health) on the Apps screen.
- 2 Tap **Heart rate**.

- 3 Tap **Measure** to begin measuring your heart rate.  
Check the measured heart rate on the screen.



To view additional information which is related to the heart rate, use the bezel or swipe upwards or downwards on the screen.

## Changing the heart rate measurement settings

- 1 Tap  (**Samsung Health**) on the Apps screen.
- 2 Tap **Settings**.
- 3 Tap **Heart rate** and select the measurement settings under **Measurement**.
  - **Measure continuously**: Your heart rate will be measured continuously.
  - **Every 10 mins while still**: Your heart rate will be measured every 10 minutes while resting.
  - **Manual only**: Your heart rate will be measured manually only when tapping **Measure**.

## Setting the heart rate alert

You can receive an alert when your heart rate is higher or lower than the resting heart rate value you set and it lasts more than 10 minutes.

- 1 Tap  (**Samsung Health**) on the Apps screen.
- 2 Tap **Settings**.
- 3 Tap **Heart rate** and set the alert under **Heart rate alert**.
  - **High HR**: Set to receive an alert when your heart rate is consistently higher than the heart rate value you set.
  - **Low HR**: Set to receive an alert when your heart rate is consistently lower than the heart rate value you set.

## Stress

Check your stress level by using your real time bio-markers and reduce your stress by following the breathing exercise that the Watch provides.





- The more frequently you measure your stress level, the more accurate your results will be due to the accumulated data.
- Your measured stress level is not necessarily related to your emotional state.
- Your stress level may not be measured, while you are sleeping, working out, moving a lot, or immediately after you finish a workout.
- For accurate measurements, wear the Watch firmly around your lower arm above the wrist. Refer to [How to wear the Watch for accurate measurements](#) for more information.
- This feature may not be available depending on the region.

### Measuring your stress level manually

- 1 Tap  (Samsung Health) on the Apps screen.
- 2 Tap **Stress**.
- 3 Tap **Measure** to begin measuring your stress level.  
Check the measured stress level on the screen.



## Alleviating stress with the breathing exercise

- 1 Tap  (Samsung Health) on the Apps screen.
- 2 Tap **Stress** and move to the breathe screen by using the bezel or swiping upwards on the screen.
- 3 Tap  or  to change the number to breathe. To change the breathe duration, tap **Breathe duration**.
- 4 Tap **Start** and start breathing.  
To stop the breathing exercise, tap on the screen and tap .

## Blood oxygen

Measure your blood's oxygen level to check whether your blood is properly delivering oxygen to the different parts of your body.

 This feature is only for your general wellness and fitness. Therefore, do not use it for medical purposes, such as diagnosing the symptoms, treatment, or prevention of disease.

### Be aware of following conditions before measuring your blood oxygen level:

- Rest for 5 minutes before taking measurements.
- During winter or in cold weather, keep yourself warm when measuring your blood oxygen level.
- Blood oxygen level measurements may vary depending on the measurement method and the environment they are taken in.

## Measuring your blood oxygen level manually

- 1 Tap  (Samsung Health) on the Apps screen.
- 2 Tap **Blood oxygen**.

3 Tap **Measure** to begin measuring your blood oxygen level.

 **Correct measurement posture**

- For accurate measurements, wear the Watch firmly around your lower arm above the wrist while leaving two fingers' worth of space as shown in the figure below. Also, place your elbow on the table while positioning your wrist close to your heart.

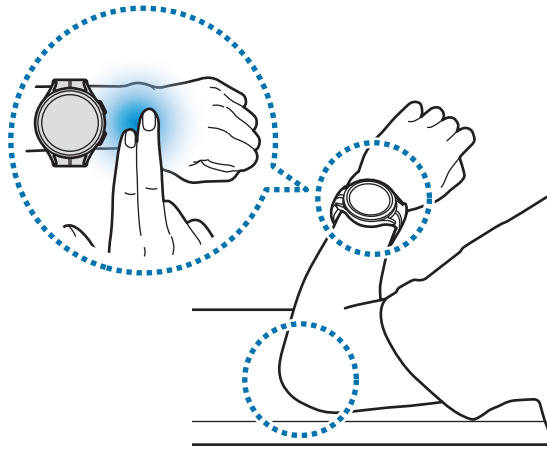

- Do not move and stay in the correct posture until finishing measurement.
- You can view how to measure your blood oxygen level in detail on the screen by tapping **How to measure**.

Check the measured blood oxygen level on the screen. If your resting blood oxygen level is between 95% and 100%, it is assumed to be within the normal range.



## Measuring your blood oxygen level while sleeping

Set to measure your blood oxygen level continuously while sleeping.



- 1 Tap  (**Samsung Health**) on the Apps screen.
- 2 Tap **Settings**.
- 3 Tap the **Blood oxygen during sleep** switch to activate it.  
Your sleeping blood oxygen level will be measured along with your other sleep records when you sleep while wearing the Watch.

-  • If you set it to measure your blood oxygen level continuously while sleeping, the battery will drain more quickly than normal.
- You can see the light due to the flickering optical heart rate sensor while measuring your blood oxygen level.
- The Watch may measure your blood oxygen level even if you are not sleeping because your Watch can recognise your sleep status even while reading books or watching TV or movies.
- Wear the Watch firmly, ensuring that you are not making space between your wrist and the Watch due to turning over in your sleep.

## Water

Record and track how many glasses of water you drink.

### Recording water consumption

- 1 Tap  (**Samsung Health**) on the Apps screen.
- 2 Tap **Water**.
- 3 Tap  when you drink a glass of water.  
If you accidentally added an incorrect value, you can fix it by tapping .

### Setting your target consumption

- 1 Tap  (**Samsung Health**) on the Apps screen.
- 2 Tap **Water** and tap **Set target**.
- 3 Use the bezel or swipe upwards or downwards on the screen to set the daily target.
- 4 Tap **Done**.

## Together

Compare your step count records with your friends who also use the together feature of the Samsung Health app. When you start step challenges with your friends, you can view the challenge status on your Watch.

- 1 Tap  (**Samsung Health**) on the Apps screen.
- 2 Tap **Together**.

Tap **Show on phone** to view detailed information such as the status of the challenge with your friends who are also using the together feature or the step count rankings for the last seven days on your smartphone.

-  Activate the together feature in the Samsung Health app on your smartphone to check the together information on your Watch.

## Settings

You can set the various setting options related to exercise and fitness.

Tap  (**Samsung Health**) on the Apps screen and tap **Settings**.

- **Measurement:** Set how to measure your heart rate and stress, and turn the additional features that can be measured during sleep on or off.
- **Auto detect workouts:** Set the auto detect workouts feature and select the exercise types to be detected.
- **Inactive time:** Set the time and days for receiving alerts after 50 minutes of inactivity.
- **Share data with devices and services:** Set to share information with other connected health platform apps, exercise machines, and TVs.



# Samsung Health Monitor

## Introduction

You can conveniently measure your blood pressure or ECG whenever you want to check them with the Samsung Health Monitor app of your Watch that includes both the optical heart rate sensor and electrical biosensor. You can check the measurement history using the Samsung Health Monitor app on your smartphone since your Watch and smartphone have been synced automatically.

Manage your health more systemically with your physician based on your measurement results.

-  • If you have not installed the Samsung Health Monitor app on your connected smartphone, launch the **Samsung Health Monitor** app on your Watch and follow the on-screen instructions to download it from the **Galaxy Store** on the smartphone.
- The Samsung Health Monitor app is only supported on the Samsung smartphones.
- Individuals under the age of 22 cannot use the Samsung Health Monitor app to measure your blood pressure or take your ECG.
- This feature may not be available depending on the region.

## Precautions for measuring blood pressure and ECG

### Common precautions

- The Samsung Health Monitor app cannot be used for medical purposes, such as diagnosing hypertension, cardiac disorders, and other heart conditions. Do not use this app for purpose of replacing a physician's medical judgment or treatment under any circumstances. In case of an emergency, contact a nearby hospital immediately.
- Do not change your medication, dosage, or usage without your physician's advice.
- The readings and results from the Samsung Health Monitor app are only for reference. Do not use them for making medical decisions without your physician's opinion under any circumstances.
- For accurate measurements, wear the Watch firmly around your lower arm above the wrist. Refer to [How to wear the Watch for accurate measurements](#) for more information.



- Before measuring your blood pressure or ECG, prepare a comfortable chair and a table to rest your arm and smartphone on.
- Seat yourself in the comfortable chair you prepared with your back supported. Do not sit with your legs crossed, and keep both of your feet on the ground.
- Be sure to place your arm comfortably on a table when you are measuring your blood pressure or taking an ECG.
- Rest for at least five minutes in a comfortable position before measuring your blood pressure or taking your ECG.
- Measure your blood pressure or ECG in a quiet place indoors.
- Do not measure your blood pressure or ECG while engaging in physical activity.
- Stay still and do not speak once you start measuring your blood pressure or taking your ECG, and do not move or speak until the measurement is complete.
- Do not measure your blood pressure or take your ECG when you are in close vicinity of machines that produce strong electronic fields, such as MRIs (Magnetic Resonance Imaging), X-ray machines, electromagnetic anti-theft systems, or metal detectors.
- Always connect your Watch to your smartphone at home or in a safe place via Bluetooth for security reasons. It is not recommended to connect to a smartphone in a public place.
- Do not measure your blood pressure or take your ECG during medical treatments, such as operations or defibrillation.
- Measure your blood pressure or ECG in an environment where the temperature is between 12 °C to 40 °C, and the relative humidity is between 30% to 90%.



### **Precautions for measuring the blood pressure**

- Avoid consuming alcohol, food that includes caffeine, smoking, exercising, and taking a bath 30 minutes before measuring your blood pressure.
- Make sure your wrist is dry when measuring your blood pressure and do not measure it when you have applied lotion or are sweating excessively.
- Do not take a deep breathe or breathe slowly on purpose, but breath as usual while measuring your blood pressure.
- If you are pregnant, your results may not be accurate when you measure your blood pressure.
- Do not measure your blood pressure with the Samsung Health Monitor app if you have any of the following conditions:
  - Arrhythmia
  - Underlying heart disease or have suffered a heart attack
  - Circulatory or peripheral vascular disease
  - Valvular heart disease (Aortic valve disease)
  - Myocardiopathy
  - Other cardiovascular disease
  - End-stage renal disease (ESRD)
  - Diabetes
  - Neurotic disorders (e.g. shivering)
  - Hemostatic disorders or if you are taking a blood thinner
- Do not use a wrist that has been tattooed or has marks on it when measuring your blood pressure because the optical heart rate sensor may be affected by the tattoos or marks.
- The Samsung Health Monitor app calibrates and measures blood pressure based on the readings from the arm that is wearing the blood pressure manometer. You must consult your physician if there is a large difference between the blood pressure in both of your arms (more than 10 mmHg).

- ⚠ Do not use a Watch which has been calibrated for other people for measuring your blood pressure.
- The measurable reading range of the Samsung Health Monitor app for blood pressure is as follows: If it has been calibrated, the systolic blood pressure range is 80 mmHg to 170 mmHg, and the diastolic blood pressure is 50 mmHg to 110 mmHg. In case of measurement, the systolic blood pressure range is 70 mmHg to 180 mmHg, and the diastolic blood pressure is 40 mmHg to 120 mmHg.
- The signal may be affected by the brightness of the individual's skin, the amount of blood under their skin, and the cleanliness of the sensor.

### ⚠ **Precautions for measuring the ECG**

- Make sure your wrist is not too dry when measuring your ECG. You can get a more accurate ECG signals when your skin that comes in contact with the sensor is moist with a moderate amount of sweat, toner, or lotion.
- Do not measure your ECG if you have an implanted cardiac pacemaker, defibrillator, or if any other electronic device is inside of your body.
- If you are pregnant, the results may not be accurate when you take your ECG.
- Do not take your ECG with the Samsung Health Monitor app if you have arrhythmia, unless it is because of atrial fibrillation.
- The Samsung Health Monitor app cannot detect heart attacks. If you have any suspicious symptoms of a heart attack, contact emergency services immediately.

## Starting to measure the blood pressure

### Presetting before measuring the blood pressure

Enter your profile on the Samsung Health Monitor app and calibrate your Watch before measuring your blood pressure. If you do not enter a profile, you cannot measure your blood pressure, and if you do not calibrate the Watch or have someone else calibrate it, the readings will be invalid.

- 📝 Be sure to calibrate the Watch with cuff-typed blood pressure manometer when measuring your blood pressure with the Samsung Health Monitor app for the first time after purchasing the Watch. Afterwards, recalibrate it every 28 days. The cuff-typed blood pressure manometer is sold separately.

- 1 Tap  (**Samsung Health Monitor**) on the Apps screen.
- 2 Tap **Blood pressure** → **Open phone app**.  
The Samsung Health Monitor app will be launched on your smartphone.
- 3 Tap **Accept**.
- 4 Enter your profile information, such as your name, gender, and birthday, and tap **Continue**.
- 5 Tap **Calibrate the watch**.
- 6 Wear the cuff of the blood pressure manometer on the upper part of the arm not wearing the Watch. Refer to the blood pressure manometer's user manual for more information about correctly wearing the cuff.
- 7 Follow the on-screen instructions to complete the calibration.

## Measuring your blood pressure

You can measure your blood pressure by using your Watch's optical heart rate sensor without using any other medical devices, such as the cuff-typed blood pressure manometer, after calibration.

 You have to wear your Watch on the same wrist used for calibration.

- 1 Tap  (**Samsung Health Monitor**) on the Apps screen.
- 2 Tap **Blood pressure** → **Measure**.  
Check the measured systolic and diastolic blood pressure and pulse rate on the screen.



## Checking the readings

Check the readings on the Watch's screen after measuring your blood pressure. You can view the previous readings and information on the connected smartphone's Samsung Health Monitor app. Share, delete, and manage your results on the smartphone's Samsung Health Monitor app.

If your readings are abnormally high or low and feel some unusual physical symptoms, contact a nearby hospital immediately for proper medical attention. Measure at least 2 more times again if you are judged not to be in an emergency situation.

## Starting to measuring the ECG

### Presetting before measuring the ECG

Enter your profile on the Samsung Health Monitor app before measuring your ECG. If you do not enter a profile, you cannot measure your ECG.

- 1 Tap  (**Samsung Health Monitor**) on the Apps screen.
- 2 Tap **ECG** → **Open phone app**.  
The Samsung Health Monitor app will be launched on your smartphone.
- 3 Tap **Accept**.
- 4 Enter your profile information, such as your name, gender, and birthday, and tap **Continue**.
- 5 Tap **Get started** and follow the on-screen instructions to get ready for measuring your ECG.

## Measuring the ECG

Manage your health by checking your heart status conveniently in advance through the ECG measurement results.

- 1 Tap  (**Samsung Health Monitor**) on the Apps screen.
- 2 Tap **ECG** → **OK** and place a finger lightly on the electrical biosensor. Do not leave any space between your wrist and your Watch.

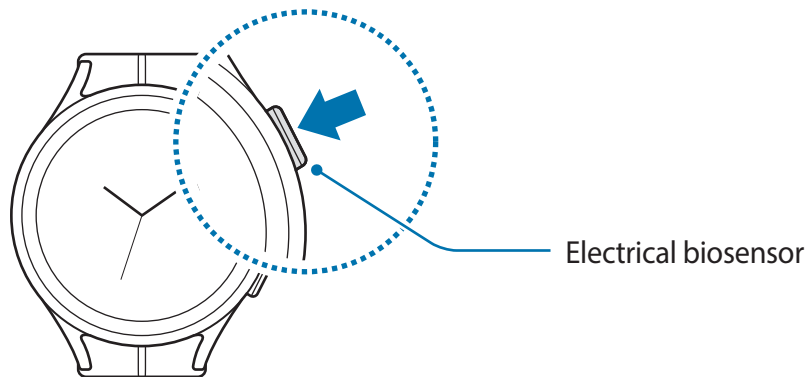

The measurement will start and the ECG wave will appear on the screen.

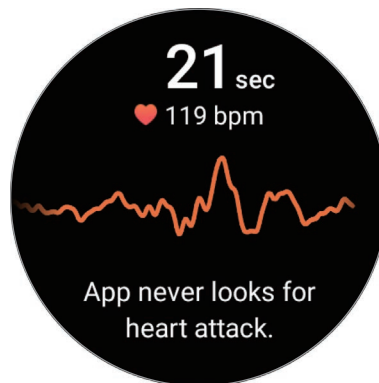

- 3 Tap **Add** to select additional physical symptoms that you are currently experiencing after the measurement and tap **Save**.
- 4 Tap **Done**.

## Checking the results

Check the results and ECG wave on the Watch and the connected smartphone's Samsung Health Monitor app screen after taking your ECG. The ECG wave shows heart rate rhythm and electric activities of your heart, and it is divided into several parts. Share the ECG graph and results with your physician to get an accurate diagnosis through a more thorough checkup when you find an abnormal results from your ECG wave and readings.

You can view the previous results and information on the connected smartphone's Samsung Health Monitor app. Share, delete, and manage your results on the smartphone's Samsung Health Monitor app.

- **Sinus rhythm:** A normal heartbeat rhythm that is between 50 - 100 BPM.
- **AFib:** A type of arrhythmia where the heart beats irregularly. Consult your physician.
- **Inconclusive:** The result is not a type of **Sinus rhythm** nor **AFib** and falls into one of the following conditions:
  - When the heart rate is less than 50 or more than 100 BPM while recording the ECG wave and there is also no **AFib**
  - When the ECG wave is not sorted as **Sinus rhythm** nor **AFib**
  - When the heart rate is more than 120 BPM and the ECG wave indicates **AFib**
- **Poor recording:** It appears when the signals used for analysing the ECG measurement result is not measured properly. If this case, take the measurement again.



Contact to your physician or a nearby hospital if **Inconclusive** or **Poor recording** appears continuously and you feel some unusual physical symptoms.





- If **Poor recording** appears continuously, wipe out the electrical biosensor and measure your ECG again. The signal may be experiencing interruptions due to the dryness of the skin on the sensor or hair on your wrist. In this case, measure your ECG after applying toner or lotion to make your skin moist or after removing some hair first.
- If the ECG wave appears upside down, it may not be analysing properly. Wear your Watch in the correct direction and measure your ECG again after checking the settings on the wrist you wear it on. You can set the Watch to match the wrist you wear it on, whether it is the left or right, by tapping  (**Settings**) on the Apps screen and tapping **General** → **Orientation**.



## GPS

The Watch has a GPS antenna so that you can check your real-time location information without connecting to a smartphone.

On the Apps screen, tap  (**Settings**) → **Location** and tap the switch to activate it.

-  • When your Watch and smartphone are connected, this feature uses your smartphone's GPS. Activate the smartphone's location feature to use the GPS sensor.
- The GPS antenna in your Watch will be used when using the Samsung Health feature and the health platform apps, even though your Watch is connected to your smartphone.
- GPS signal strength may decrease in locations where the signal is obstructed, such as between buildings or in low-lying areas, or in poor weather conditions.

## Music

Listen to music saved in your Watch.

Tap  (**Music**) on the Apps screen.

Drag the  icon upwards and tap **Library** to open the Library screen. On the Library screen, you can view the playlist and arrange music by tracks, albums, and artists.

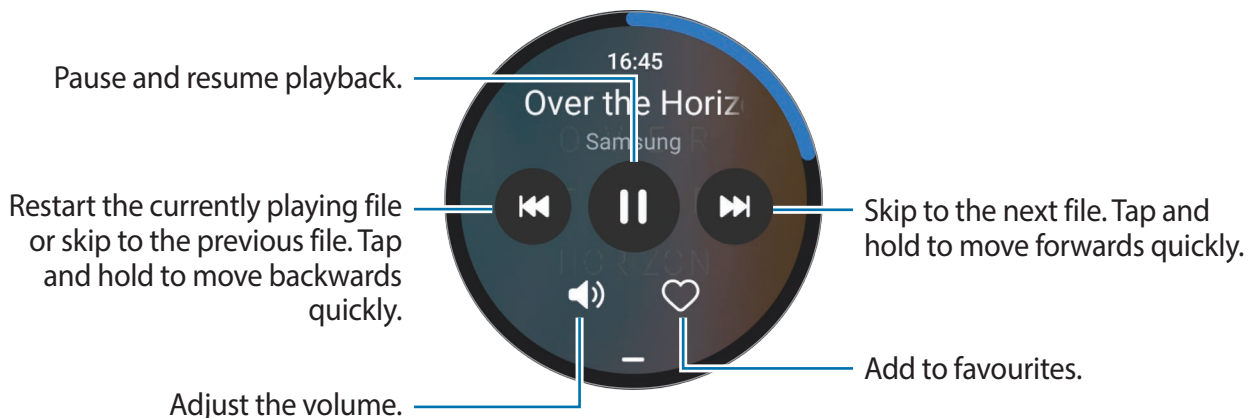



-  To save music in your Watch, launch the **Galaxy Wearable** app on your smartphone, tap **Watch settings** → **Manage content** → **Add tracks**, select music you want to send to the Watch from the connected smartphone, and then tap **Add to watch**.

# Media Controller

## Introduction

Control the media app installed on your Watch or the connected smartphone to play or pause music and video.

-  To launch this app automatically from your Watch when you play music or videos on the connected smartphone, on the Apps screen, tap  (**Settings**) → **Display** and tap the **Show media controls** switch to activate it.

## Controlling the music player

- 1 Tap  (**Media Controller**) on the Apps screen.
- 2 Select **Phone** or **Watch**.

When you select **Phone**, you can play music on the connected smartphone's music app and you can control the music player with your Watch.

When you select **Watch**, you can play music on your Watch's music app and you can listen to music with your Watch's speaker or a connected Bluetooth headset.

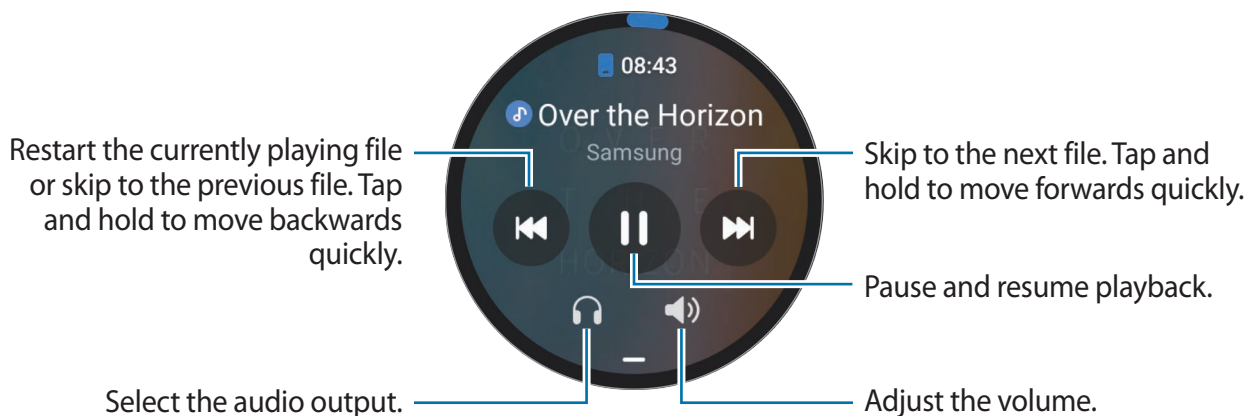

## Controlling the video player



- 1 Play video on the connected smartphone.
- 2 Tap  (**Media Controller**) on the Apps screen.
- 3 Tap **Phone**.  
You can control the video player with your Watch.

## Reminder

Register to-do items as reminders and receive notifications according to the condition you set.



- To receive reminder notifications in a specific place, you have to connect your Watch to your smartphone via Bluetooth. However, the feature for setting you to receive reminder notifications in a specific place is only available on your smartphone.
- All reminders on your Watch will be synced with the connected smartphone automatically so that you can also receive alarms and check them from the smartphone.

- 1 Tap  (**Reminder**) on the Apps screen and tap **Write**.  
If you have a saved reminder, tap  on the top of the reminders list.
- 2 Enter the reminder.
- 3 Tap **Set time** to set a notification.
- 4 Tap the input field, use the bezel, or swipe upwards or downwards on the screen to set the time, and tap **Next**.
- 5 Set other notification options, such as the date when to receive the notification and whether to repeat the notification, and tap **Done**.
- 6 Tap **Save**.  
The saved reminder is added to the reminders list and the reminder will display at the time you set with an alarm.

### Completing reminders

On the reminders list, tap  or select a reminder and tap **Complete**.

### Restoring reminders

Restore reminders that have been completed.

- 1 On the reminders list, tap **Completed**.
- 2 Select a reminder to restore and tap **Restore**.  
Reminders will be added to the reminders list and you will be reminded again.

### Deleting reminders

Tap and hold the reminder on the reminder list, and then tap **Delete**.

## Calendar

You can check the 7-day schedules of events that you saved in your smartphone on your Watch.

Tap  (**Calendar**) on the Apps screen to check the schedules of events that you saved in your smartphone.

To add your schedule, tap **Show on phone** and add it on the connected smartphone.

## Bixby

Bixby is a user interface that helps you use your Watch more conveniently.

You can talk to Bixby. Bixby will launch a function you request or show the information you want.

Visit [www.samsung.com/bixby](http://www.samsung.com/bixby) for more information.



- Make sure the Watch's microphone is not obstructed when you are speaking into it.
- Bixby is only available in some languages, and certain features may not be available depending on your region.

### Starting Bixby

Press and hold the Home key to launch Bixby. The Bixby intro page will appear. Complete the setup by following the on-screen instructions.

If you cannot launch Bixby with the Home key, on the Apps screen, tap  (**Settings**) → **Advanced features** → **Customise keys**, tap **Press and hold** under **Home key**, and then select **Bixby**.

### Using Bixby

While pressing and holding the Home key, say what you want to Bixby, and then release your finger from the key. Alternatively, say "Hi, Bixby" after turning on the screen and say what you want.

For example, while pressing and holding the Home key, say "How's the weather today?" The weather information will appear on the screen with voice feedback.

If you want to know the weather tomorrow, while pressing and holding the Home key, just say "Tomorrow?"

If Bixby asks you a question during a conversation, while pressing and holding the Home key, answer Bixby. Or, tap  and answer Bixby.



### **Tips for better voice recognition**

- Speak clearly.
- Speak in quiet places.
- Do not use offensive or slang words.
- Avoid speaking in dialectal accents.

The Watch may not recognise your commands or may perform unwanted commands depending on your surroundings or how you speak.

### **Waking up Bixby using your voice**

You can start a conversation with Bixby by saying “Hi, Bixby”.

- 1 Tap  (**Bixby**) on the Apps screen. Alternatively, press and hold the Home key.
- 2 Tap  → **Settings** → **Voice wake-up**.
- 3 Tap the **Voice wake-up** switch to activate it.

## **Weather**

View weather information on the Watch for locations set on the connected smartphone.

Tap  (**Weather**) on the Apps screen.

To view the weather information, such as the time-specific weather or weekly information, use the bezel or swipe upwards or downwards on the screen.

To add another city’s weather information, tap your current location at the top of the screen, tap **Manage on phone**, and then add the city from the connected smartphone.

## Alarm

Set and manage the Watch's alarms and the smartphone's alarms individually.

-  When your Watch is connected to your smartphone via Bluetooth, you can check all alarm lists on your smartphone from the Watch.

### Setting alarms

- 1 Tap  (**Alarm**) on the Apps screen.
- 2 Tap **Add on watch** to set alarms that only go off on your Watch.  
You can also add an alarm from the connected smartphone by tapping **Add on phone**.
- 3 Tap the input field, use the bezel or swipe upwards or downwards on the screen to set the alarm time, and tap **Next**.
- 4 Set other alarm options, such as the date when to go off and whether to repeat the alarm, and tap **Save**.  
The saved alarm is added to the alarms list.

To activate or deactivate alarms, tap the switch next to the alarm in the alarms list.

### Stopping alarms

Drag  outside the large circle to stop an alarm. Alternatively, swipe the bezel clockwise.

If you want to use the snooze function, drag  outside the large circle. Alternatively, swipe the bezel anticlockwise.

### Deleting alarms

In the alarms list, tap and hold an alarm, and then tap **Delete**.



## World Clock

Tap  (**World Clock**) on the Apps screen to view the world clocks added from the smartphone.

To add a world clock, tap **Add on phone**. Or, if you have added world clocks, tap **Manage on phone**, and then add or remove a world clock on the connected smartphone.

# Timer

## Setting a timer

- 1 Tap  (**Timer**) on the Apps screen.
- 2 Tap .
- 3 Tap the input field, use the bezel or swipe upwards or downwards on the screen to set the duration, and tap .





 If you select a preset, the timer will start right away. You can also view more presets by using the bezel or swiping upwards or downwards on the screen.

## Dismissing a timer

Drag  outside the large circle when your timer goes off. Alternatively, swipe the bezel clockwise.

To restart the timer, drag  outside the large circle. Alternatively, swipe the bezel anticlockwise.

# Stopwatch

- 1 Tap  (**Stopwatch**) on the Apps screen.
- 2 Select the stopwatch style you want by using the bezel or swiping left or right on the screen.  
To change the stopwatch style, tap and hold the screen.
- 3 Tap **Start** to time an event.  
To record lap times while timing an event, tap **Lap** or .
- 4 Tap **Stop** or  to stop timing.
  - To restart the timing, tap **Resume** or .
  - To clear lap times, tap **Reset** or .

# Gallery



## Importing and exporting images

### Importing images from your smartphone

- 1 Launch the **Galaxy Wearable** app on your smartphone.
- 2 Tap **Watch settings** → **Manage content**.
- 3 Tap **Add images**.
- 4 Select a category, select files, and then tap **Done**.

To sync images on your smartphone with your Watch, tap the **Auto sync** switch under **Gallery** to activate it. Then, tap **Albums to sync**, select albums to import to your Watch, and then tap **Done**. The selected albums will be automatically synced with your Watch when it has more than 15 % of remaining battery power, when its storage is more than 50 MB, and when power saving mode is deactivated on your Watch.

### Exporting images to your smartphone

- 1 Tap  (**Gallery**) on the Apps screen.
  - 2 Tap and hold the image to export it.
  - 3 Use the bezel or swipe left or right on the screen and select any images to export more. To select all images, tap **All**.
  - 4 Tap .
- You can view the exported images in apps like Gallery on your smartphone.

## Viewing images

View and manage the images saved on your Watch.

- 1 Tap  (**Gallery**) on the Apps screen.
- 2 Use the bezel or swipe upwards or downwards on the screen to scroll through the image list and select an image.





## Zooming in or out

While viewing an image, double-tap the image quickly, spread your two fingers apart, or pinch on an image to zoom in or out.



When an image is magnified, you can view the rest of the image by scrolling around the screen.

## Deleting images

- 1 Tap  (**Gallery**) on the Apps screen.
- 2 Tap and hold the image to delete it.
- 3 Use the bezel or swipe left or right on the screen and select any images to delete more. To select all images, tap **All**.
- 4 Tap .

## Find My Phone

If you misplace the smartphone, the Watch can help you find it.

- 1 Tap  (**Find My Phone**) on the Apps screen.
- 2 Tap **Start**.  
The smartphone will make a sound and vibrate, and its screen will turn on.  
To stop making sound and vibrating, tap  and drag it on the smartphone, or tap **Stop** on the Watch.

## Find My Watch

If you misplace your Watch, the Galaxy Wearable app on your connected smartphone or the SmartThings Find feature of the SmartThings app installed on your connected smartphone can help you find it.

-  The screen may be switched automatically to find your Watch with the SmartThings Find feature if the connected smartphone supports the SmartThings Find feature.

### Finding with the Galaxy Wearable app

1 Launch the **Galaxy Wearable** app on your smartphone and tap **Find My Watch**.

2 Tap **Start**.

The Watch will make a sound and vibrate, and its screen will turn on.

To stop making sound and vibrating, drag  outside the large circle on the Watch.

Alternatively, swipe the bezel. You can also stop it by tapping **Stop** on the smartphone.

### Controlling the Watch remotely

When your Watch is lost or stolen, launch the **Galaxy Wearable** app on your smartphone, tap **Find My Watch** → **Set security**, and then control your Watch remotely.

### Finding with the SmartThings Find feature of the SmartThings app

Launch the **Galaxy Wearable** app on your smartphone and tap **Find My Watch**.

The SmartThings Find screen of the SmartThings app will appear on the smartphone and you can check your misplaced Watch's location on the map. Also, you can find it by following the sound emitted from your Watch.

# Sending an SOS

## Introduction

In an emergency, you can send an SOS message that includes your location information to previously registered contacts, or you can set it up your Watch to send an SOS message automatically when you are hurt from a fall and your Watch recognises it. Also, you can set the Watch to automatically make an emergency call to a previously registered contact.



- If the GPS feature is not activated on your Watch when sending an SOS, the GPS feature will be activated automatically to send the location information.
- Your location information may not be sent depending on your region or situation.

## Registering the emergency contacts

Register the emergency contact to send an SOS message and make an emergency call to in an emergency.

- 1 Launch the **Galaxy Wearable** app on your smartphone and tap **Watch settings** → **Safety and emergency**.
- 2 Tap **Send messages to**.
- 3 Tap **Create contact** and enter new contact information or tap **Select from Contacts** to add an existing contact as an emergency contact.

You can select a contact to make an emergency call to from the contacts you registered for SOS messages. Launch the **Galaxy Wearable** app on your smartphone, tap **Watch settings** → **Safety and emergency** → **Make SOS call to**, and then select a contact.

## Requesting an SOS

### Setting the SOS request

- 1 Launch the **Galaxy Wearable** app on your smartphone and tap **Watch settings** → **Safety and emergency**.
- 2 Tap **SOS with Home key** and tap the switch to activate it.  
To set a delay time for sending an SOS message that will give you time to cancel the message after quickly pressing the Watch's Home key several times, tap the **Count down before sending** switch to activate it.

## Sending an SOS request

In an emergency, quickly press the Watch's Home key several times.

The SOS message will be sent and the emergency call will be made to the previously registered contacts.

The  icon will appear on the Watch screen while sending an SOS message and you can check the SOS request result on the notification panel after the SOS message has been sent.

## Requesting an SOS when you are hurt from a fall

### Setting the SOS request when you are hurt from a fall

- 1 Launch the **Galaxy Wearable** app on your smartphone and tap **Watch settings** → **Safety and emergency**.
- 2 Tap **Hard fall detection** and tap the switch to activate it.  
Select the condition in which your Watch will detect the hurt from a fall under **When to detect falls**.

### Sending an SOS request when you are hurt from a fall



When a big impact occurs, the Watch will detect the hurt from a fall through your arm's movement and it will display the notification while vibrating and emitting sound.

If you do not respond within 60 seconds, a siren will sound for 30 seconds, and then an SOS message will be sent out automatically. Then emergency call will be made to a previously registered contact.

After the Watch detects your fall, cancel the alert not to send the SOS message whenever you want or send an SOS message manually.

-  The Watch may believe that you have been hurt in a fall if you are doing a high impact exercise. If it is so, cancel the alert not to send the SOS message.

## Stopping SOS messages



When the  icon appears on the Watch screen, check your location information sharing status on the notification panel. To stop sharing your location information, tap the screen and tap **Stop sharing** → .

 If you do not stop sending SOS messages, additional messages that include your location information will be continuously sent to the previously registered contacts every 15 minutes for 24 hours after the first SOS message is sent. However, the message will be sent only when your current location is some distance away from the location where the last message is sent.

## Voice Recorder

Record or play voice recordings.

### Making voice recordings

- 1 Tap  (**Voice Recorder**) on the Apps screen.
- 2 Tap  to start recording. Speak into the Watch's microphone. To pause recording, tap .

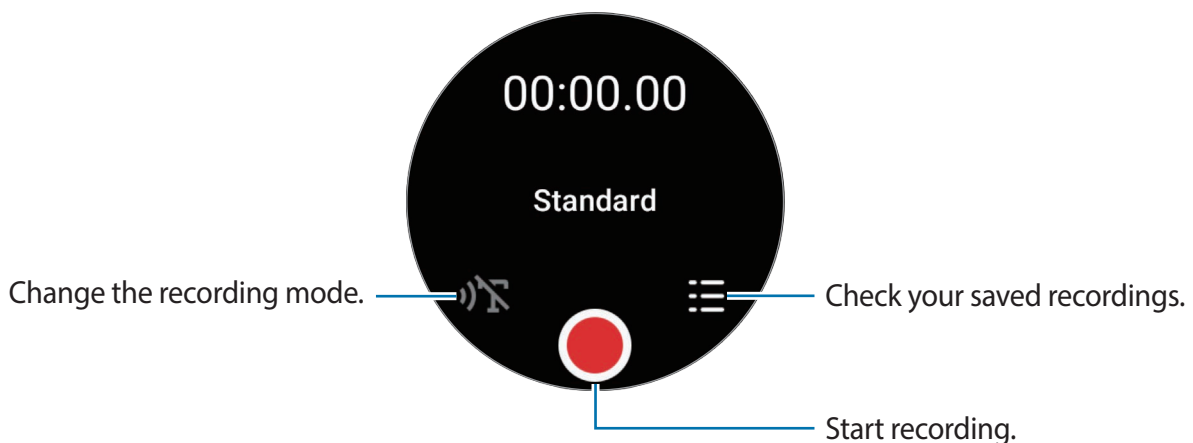



- 3 Tap  to finish recording. The recording will be saved automatically.
- 4 To listen to the recorded sound, select a recording file and tap **Play**.

## Changing the recording mode

Tap  (**Voice Recorder**) on the Apps screen.

Select a mode you want.

-  : This is the normal recording mode.
-  : The Watch records your voice for up to 10 minutes, converts it to text, and then saves it. For best results, keep the Watch near your mouth and speak loudly and clearly in a quiet place.
  -  If the speech-to-text language does not match the language you are speaking, the Watch will not recognise your voice. Before using this feature, tap **Speech-to-text** to set the speech-to-text language.

## Calculator

You can perform simple calculations.

Tap  (**Calculator**) on the Apps screen.



You can use this app when leaving a tip or using the unit conversion tool by dragging the  icon upwards.

## Compass

You can use your Watch as a compass.

Tap  (**Compass**) on the Apps screen.

You can check additional information, such as the incline, altitude, and atmospheric pressure, by dragging the  icon upwards.

-  The presence of magnetic substances, such as the wireless charger, may affect to your Watch's internal compass sensor and lower its accuracy. Drag the  icon upwards and tap **Calibrate** to calibrate the compass by swinging the wrist you are wearing the Watch on.

## Buds Controller

You can check the battery status of the Galaxy Buds connected to the Watch and change their settings.





Tap  (**Buds Controller**) on the Apps screen.

## Camera Controller

You can remotely control the cameras of the smartphone connected to the Watch and take pictures or record videos from a distance.

1 Tap  (**Camera Controller**) on the Apps screen.

The Camera app will be launched on the connected smartphone.

2 Check the preview screen, and tap  to take a picture or tap  to record a video. To change the shooting mode, tap  or .

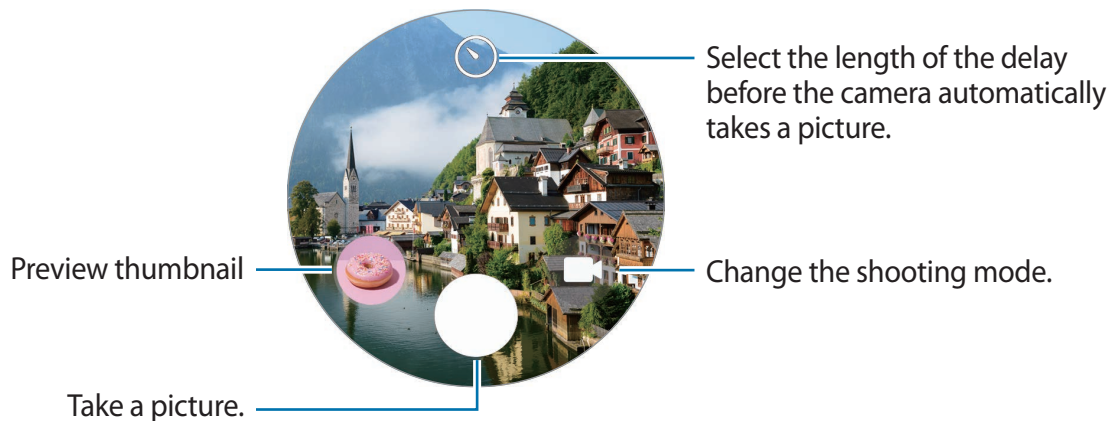

 This app may not be available depending on the connected smartphone.

## Samsung Global Goals

The Global Goals, which were established by the United Nations General Assembly in 2015, consist of goals that aim to create a sustainable society. These goals have the power to end poverty, fight inequality, and stop climate change.

With Samsung Global Goals, learn more about the global goals and join the movement for a better future.

## Google apps

Google provides some apps for Watch. You may require a Google account to access some apps.

- **Maps:** Find your location on the map and search the world map.
- **Messages:** Send and receive messages on your Watch or smartphone.

 Some apps may not be available depending on the service provider or model.

## Settings

### Introduction

Customise settings for functions and apps. Set your Watch depending on your usage pattern by configuring the various settings.

Tap  (**Settings**) on the Apps screen.

 Some features in Settings may not be available depending on the region, service provider, or model.

### Samsung account

Register the Samsung account on your connected smartphone or check the previously registered Samsung account.

On the Settings screen, tap **Samsung account**.

### Connections

#### Bluetooth

Connect to a smartphone via Bluetooth. You can also connect other Bluetooth-enabled devices, such as a Bluetooth headset or computer.

On the Settings screen, tap **Connections** → **Bluetooth**.



## Precautions for using Bluetooth

- Samsung is not responsible for the loss, interception, or misuse of data sent or received via Bluetooth.
- Always ensure that you share and receive data with devices that are trusted and properly secured. If there are obstacles between the devices, the operating distance may be reduced.
- Some devices, especially those that are not tested or approved by the Bluetooth SIG, may be incompatible with your device.
- Do not use the Bluetooth feature for illegal purposes (for example, pirating copies of files or illegally tapping communications for commercial purposes). Samsung is not responsible for the repercussion of illegal use of the Bluetooth feature.

## Wi-Fi

Activate the Wi-Fi feature to connect to a Wi-Fi network.

- 1 On the Settings screen, tap **Connections** → **Wi-Fi**, and tap the switch to activate it.
- 2 Select a network from the Wi-Fi network list under **Available networks**.  
Networks that require a password appear with a lock icon.
- 3 Tap **Connect**.

 If you cannot connect to a Wi-Fi network properly, restart your Watch's Wi-Fi feature or the wireless router.

## NFC

You can use this feature to make payments and buy tickets for transportation or events after downloading the required apps.

On the Settings screen, tap **Connections** → **NFC**.

 The Watch contains a built-in NFC antenna. Handle the Watch carefully to avoid damaging the NFC antenna.

## Making payments with the NFC feature

Before you can use the NFC feature to make payments, you must register for the mobile payment service. To register or get more information about the service, contact your service provider.

- 1 On the Settings screen, tap **Connections** → **NFC** and tap the switch to activate it.

2 Touch the NFC antenna area of the Watch to the NFC card reader.

To set the default app, on the Settings screen, tap **Connections** → **NFC** → **Payment** and select an app.

 The payment services list may not include all available payment apps.

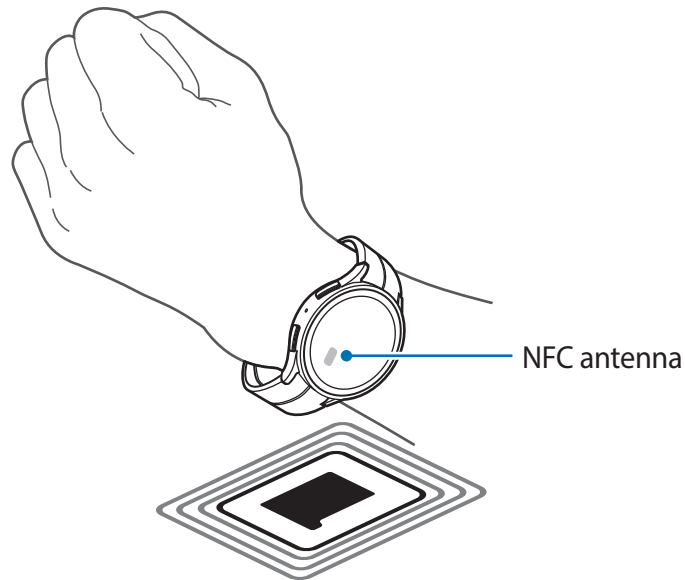

## Disconnection alerts

Set to vibrate or make an alarm when the Bluetooth connection with your smartphone is disconnected while you are wearing your Watch.

On the Settings screen, tap **Connections** → **Disconnection alerts** and select an alert option you want.

## Flight mode

This disables all wireless functions on your Watch. You can use only non-network services.



On the Settings screen, tap **Connections** and tap the **Flight mode** switch to activate it.

 Follow the regulations provided by the airline and the instructions of aircraft personnel. In cases where it is allowed to use the device, always use it in flight mode.

## Mobile networks (SM-R905F, SM-R915F, SM-R925F)

Customise the settings to control mobile networks.

On the Settings screen, tap **Connections** → **Mobile networks** and select a mobile network connection option.

- **Auto:** Set to automatically use the Watch's mobile network when the Bluetooth connection with your smartphone is disconnected.
  -  • When the Watch is connected to the smartphone via Bluetooth, the Watch's mobile network is turned off to save battery power. Then, you cannot receive messages and calls made to the Watch's number.
  - When the Bluetooth connection with your smartphone is disconnected, the Watch's mobile network will automatically connect. Then, you can receive messages and calls made to the Watch's number.
- **Always on:** Set to always use the Watch's mobile network regardless of the connection with the smartphone.
- **Always off:** Set not to use the Watch's mobile network.
- **Mobile plans:** Subscribe to the service provider's mobile plan or additional services.
  -  • Some services that require a network connection may not be available depending on the service provider.
  - When you are not subscribed to the service provider's mobile plan, the Watch's mobile network is turned off to save battery power and the network services may not be available.

## Data usage (SM-R905F, SM-R915F, SM-R925F)

Keep track of your data usage amount and customise the limit settings. Set the Watch to automatically disable the mobile data connection when you have reached your specified mobile data limit.

On the Settings screen, tap **Connections** → **Data usage**.

- **Start billing cycle on:** Set the monthly start date of your plan's data usage.
- **Set data limit:** Activate or deactivate the feature to automatically disable the mobile data connection when you have reached your specified mobile data limit.
- **Data limit:** Set the mobile data limit.

## Notifications

Change the notification settings.

On the Settings screen, tap **Notifications**.

- **Show phone notifications on watch:** Set the conditions for sending smartphone notifications to your Watch while you are wearing it.
- **Mute notifications on phone:** Set to mute the smartphone when it receives notifications that will also be sent to your Watch while you are wearing it.
- **Do not disturb:** Set the Watch to mute all notifications, including incoming call notifications, and not to turn on the screen when receiving notifications or incoming calls.
- **Advanced settings:** Configure advanced settings for notifications.
- **Wireless emergency alerts:** Change the emergency alert settings.



Some features may not be available depending on the region, service provider, or model.

## Sounds and vibration

Change the sound and vibration settings.

On the Settings screen, tap **Sounds and vibration**.

- **Sound mode:** Set to use sound mode, silent mode, or vibrate mode.
- **Vibrate with sound:** Set the Watch to vibrate with sound.
- **Vibration:** Set the vibration duration and intensity.
- **Call vibration:** Select a vibration pattern for incoming calls.
- **Notification vibration:** Select a vibration pattern for notifications.
- **Volume:** Adjust the volume level.
- **Ringtone:** Change the ringtone.
- **Notification sound:** Change the notification sound.
- **System vibration:** Enable vibrations for certain actions.
- **System sounds:** Enable sounds for certain actions.



Some features may not be available depending on the region, service provider, or model.

## Display

Change the screen settings.

On the Settings screen, tap **Display**.

- **Brightness:** Adjust the brightness for the screen.
- **Auto brightness:** Set the Watch to automatically adjust the brightness depending on the ambient light conditions.
- **Always On Display:** Set the Watch screen and some apps' screens to always stay on while wearing your Watch. However, the battery will drain more quickly than normal while using this feature.
- **Screen wake-up:** Select how to turn the screen on. Refer to [Turning the screen on](#) for more information.
- **Show media controls:** Set to automatically launch the **Media Controller** app on your Watch when music or video is played on the connected smartphone.
- **Screen timeout:** Set the length of time the Watch waits before turning off the screen's backlight.
- **Show last app:** Set the time to keep the last-used app on after the screen is turned off. If you turn the screen on again within the time you set after it has been turned off, the app screen you last used will appear instead of the Watch screen.
- **Font:** Set the font style for the screen.
- **Touch sensitivity:** Set the Watch to allow use of the touchscreen with gloves on.
- **Show charging info:** Set the Watch to display the charging information when the screen is off while charging.

## Samsung Health

You can set the various setting options related to exercise and fitness.

On the Settings screen, tap **Samsung Health**.

- **Measurement:** Set how to measure your heart rate and stress, and turn the additional features that can be measured during sleep on or off.
- **Auto detect workouts:** Set the auto detect workouts feature and select the exercise types to be detected.
- **Inactive time:** Set the time and days for receiving alerts after 50 minutes of inactivity.
- **Share data with devices and services:** Set to share information with other connected health platform apps, exercise machines, and TVs.

## Advanced features

Activate the advanced features.

On the Settings screen, tap **Advanced features**.

- **Water lock:** Activate water lock mode before entering the water. The touchscreen feature will be deactivated.
- **Bedtime mode:** Activate bedtime mode to reduce eye strain before sleeping and prevent your sleep from being disturbed.
- **Theatre mode:** Activate theatre mode to focus on watching movies.
- **Customise keys:** Select an app or feature to launch when you press the Home key twice or press and hold it. You can also select a feature to launch when you press the Back key.
- **Gestures:** Activate the gestures feature and configure the settings. Refer to [Gestures](#) for more information.

## Gestures

Activate the gestures feature and configure the settings.

On the Settings screen, tap **Advanced features** and select the feature you want under **Gestures**.

- **Answer calls:** Set to answer calls by shaking the arm which is wearing the Watch twice while bending at the elbow.
- **Dismiss alerts and calls:** Set to dismiss alerts and decline calls by rotating the wrist you are wearing your Watch on twice.
- **Quick launch:** Set to launch the selected feature quickly by moving the wrist you are wearing your Watch on up and down twice within five seconds after turning on the screen while closing your fist. Tap **Select an option** and set the feature to be launched quickly.

## Battery

Check the remaining battery. If the battery is low, activate power saving mode to reduce battery consumption.

On the Settings screen, tap **Battery**.

- **Power saving:** Activate power saving mode in which some features are restricted to reduce battery consumption.

- **Watch only:** Only the watch displays on the screen and all other features will be deactivated to reduce the battery consumption. Press the Home key to view the watch. To deactivate watch only mode, press and hold the Home key for more than three seconds. Alternatively, place the Watch on the wireless charger.

 The usage time left shows the time remaining before the battery power runs out. Usage time left may vary depending on your Watch settings and operating conditions.

## Apps

Configure the settings for the Watch's app.

On the Settings screen, tap **Apps**.

- **Choose default apps:** Choose default apps for similar features.
- **Health Platform:** Set your profile to be used for managing your health data and set to share information with other connected health platform apps, exercise machines, and TVs.
- **Permissions:** View the permission list for all apps, including the system apps, and change their permission settings.
- **Samsung app updates:** Check for updates for some preinstalled Samsung apps.

## General

Customise your Watch's general settings or reset the Watch.

On the Settings screen, tap **General**.

- **Touch bezel:** Change the touch bezel settings.
- **Text-to-speech:** Change the settings for text-to-speech features used when TalkBack is activated, such as languages, speed, and more.
- **Input:** Change the settings for the keyboard and set the quick responses feature.
- **Date and time:** Set the date and time manually.
  -  Disconnect your Watch from the smartphone to use this feature, since it is synced with the connected smartphone.
- **Orientation:** Set the Watch to match the wrist you wear it on, whether it is the left or right, and the orientation of the Home key or Back key after wearing your Watch.
- **Connect to new phone:** Connect the Watch to another new smartphone after performing a reset for all your personal information.
- **Reset:** Delete all data on your Watch.

## Accessibility

Configure various settings to improve accessibility to the Watch.

On the Settings screen, tap **Accessibility**.

- **Functions you're using:** Check the accessibility features you are using.
  -  This feature appears only when using the accessibility feature.
- **TalkBack:** Activate TalkBack, which provides voice feedback. To view help information to learn how to use this feature, tap **Settings** → **Tutorial and help**.
- **Visibility enhancements:** Customise the settings to improve accessibility for visually impaired users.
- **Hearing enhancements:** Customise the settings to improve accessibility for users with hearing impairment.
- **Interaction and dexterity:** Customise the settings to improve accessibility for users who have reduced dexterity.
- **Advanced settings:** Manage other advanced functions.
- **Installed apps:** View accessibility services installed on the Watch.

## Security

Configure your Watch's security settings.

On the Settings screen, tap **Security**.

- **Lock type:** Change the screen lock method. Refer to [Lock screen](#) for more information.

## Privacy

Change your privacy settings.

On the Settings screen, tap **Privacy**.

- **Permission manager:** View the list of features and apps that have permission to use them. You can also edit the permission settings.
- **Customisation Service:** Set to get personalised service based on your interests and how you use your Watch.



## Location

Change settings for location information usage.

On the Settings screen, tap **Location**.

- **Permissions:** Set the permission of the feature to use location information.
- **Location services:** View the location services your Watch is using.

## Safety and emergency

Change the settings for emergency alerts. You can also set to request an SOS automatically or manually when you are in emergency situations. Refer to [Sending an SOS](#) for more information.

On the Settings screen, tap **Safety and emergency**.

- **SOS with Home key:** Set to request an SOS by quickly pressing the Watch's Home key several times in an emergency.
- **Hard fall detection:** Set to request an SOS automatically when you are hurt from a fall and your Watch recognises it.
- **Wireless emergency alerts:** Change settings for emergency features, such as wireless emergency alerts.



Some features may not be available depending on the region, service provider, or model.

## Accounts and backup

You can use various features of the Watch after registering your Samsung or Google account on your connected smartphone.

On the Settings screen, tap **Accounts and backup**.

- **Samsung account:** Register the Samsung account on your connected smartphone or check the previously registered Samsung account.
- **Google account:** Check the Google account registered on your connected smartphone and copy it to your Watch.

## Google

Change the settings for Google.

On the Settings screen, tap **Google**.

- **Accounts:** Check the Google account registered on your connected smartphone and copy it to your Watch.

## Software update

Update your Watch's software via the firmware over-the-air (FOTA) service. You can also change the update settings.

On the Settings screen, tap **Software update**.

- **Download and install:** Check for and install updates manually.
- **Auto install:** Set the Watch to install updates automatically overnight, while it is being charged and has more than 30% of remaining battery power.

## Tips and tutorials

Learn the basic tips for using your Watch and view the user manual on the connected smartphone.

On the Settings screen, tap **Tips and tutorials**.

- **Tutorial:** View the tutorial for learning the Watch's basic usage tips.
- **View tips on phone:** View the detailed usage tips for your Watch on the connected smartphone.

## About watch

View the Watch's additional information.

On the Settings screen, tap **About watch**.

- **Storage:** Check the status of the used and available memory.
- **Status info:** View the information, such as the Wi-Fi MAC address, Bluetooth address, and serial number.
- **Legal info:** View legal information related to the Watch. You can also send the Watch's diagnostic information to Samsung.
- **Software info:** View the software version and security status.
- **Battery info:** View the battery information.

# Galaxy Wearable app

## Introduction

To connect your Watch to a smartphone, you must install the Galaxy Wearable app on your smartphone. You can check the Watch's remaining battery and configure the settings with the Galaxy Wearable app.

Launch the **Galaxy Wearable** app on your smartphone.

To search for settings by entering keywords, tap **Q**. You can also search for settings by selecting a tag under **Suggestions**.

 Some features may not be available depending on the type of connected smartphone.

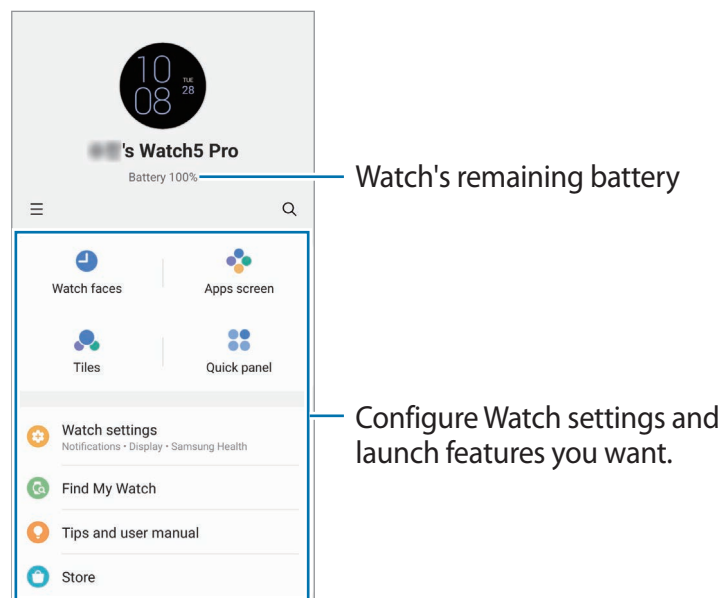

Tap **≡** to use the following additional options:

- **Add new device:** Disconnect your device from the currently connected smartphone and connect a new device. Follow the on-screen instructions to complete the connection. Refer to [Connecting the Watch to a smartphone via Bluetooth](#) for more information.
- **Auto switch:** The Watch will still automatically connect to your smartphone if you wear it on your wrist.

 This feature will be displayed only when more than two devices that support the auto switch feature are paired to your smartphone.

- **Manage devices:** Manage connected devices when more than two devices are paired with your smartphone. To disconnect a device from your smartphone, select a device and tap **Remove**.
- **Contact us: Samsung Members** offers support services to customers, such as device problem diagnosis, and lets users submit questions and error reports. You can also share information with others in the Galaxy users' community or view the latest news and tips. **Samsung Members** can help you solve any problems you might encounter while using your device.
- **About Galaxy Wearable:** View version information of the Galaxy Wearable app and change the auto update settings.



Some features may not be available depending on the region, service provider, or model.

## Watch faces

You can change the type of watch to be displayed on the Watch screen.

On the Galaxy Wearable screen of the smartphone, tap **Watch faces**.

Select a watch face you want and tap **Customise** to change screen colours or components, such as clock hands and dials, and even select items to display on the Watch screen.

### Making My style watch faces

Change your watch face into a pattern image that uses a colour combination abstracted from the picture you took. You can match your Watch's watch face with any fashion you want.



This feature is only available on Samsung or Android smartphones.

- 1 On the Galaxy Wearable screen of the smartphone, tap **Watch faces**.
- 2 Select **My style** under **Graphical**.
- 3 Tap **Customise** → **Background** → **Camera**.  
To select a picture saved on your smartphone, tap **Gallery**.
- 4 Tap  to take a picture and then tap **OK**.
- 5 Drag the picture to the collection of colours you want to use.

6 Select a pattern type and tap **Done**.

7 Tap **Save**.

The watch face will be changed into the My style one.

## Making AR emoji watch faces

Change your watch face into your own AR emoji.

 This feature is only available on Samsung smartphones that support the AR emoji features.

1 On the Galaxy Wearable screen of the smartphone, tap **Watch faces**.

2 Select **AR Emoji** under **Graphical**.

3 Tap **Customise** → **Character**.

4 Tap  and follow the on-screen instructions to make your AR emoji.

5 Select the added AR emoji under **Other emojis** to transfer it to your Watch.

6 Tap **Save**.

The watch face will be changed into the AR emoji one.



## Apps screen

Rearrange apps on the Apps screen.

On the Galaxy Wearable screen of the smartphone, tap **Apps screen**.

To rearrange apps, tap and hold an app to move, drag it to the desired position, and then tap **Save**.

## Tiles

Customise the tiles on the Watch. You can also rearrange tiles.

On the Galaxy Wearable screen of the smartphone, tap **Tiles**.

### Adding or removing tiles

Tap **+** of the tile to add under **Add tiles** or tap **−** on the tiles you want to delete, and then tap **Save**.

### Rearranging tiles

Tap and hold a tile you want to move, drag it to the desired position, and then tap **Save**.

## Quick panel

Select the quick settings icons displayed on the quick panel of your Watch. You can also rearrange quick settings icons.

On the Galaxy Wearable screen of the smartphone, tap **Quick panel**.

### Adding or removing quick setting icons

Tap **+** on the icon to add under **Available buttons** or tap **−** on the icon to delete, and then tap **Save**.

### Rearranging quick setting icons

Tap and hold an icon to move, drag it to the desired position, and then tap **Save**.

# Watch settings

## Introduction

View your Watch's status and customise your Watch settings.

On the Galaxy Wearable screen of the smartphone, tap **Watch settings**.

## Samsung account

Register the Samsung account on your connected smartphone or check the previously registered Samsung account.

On the Galaxy Wearable screen of the smartphone, tap **Watch settings** → **Samsung account**.

## Notifications

Change the notification settings.

On the Galaxy Wearable screen of the smartphone, tap **Watch settings** → **Notifications**.

- **Show phone notifications on watch:** Set the conditions for sending smartphone notifications to your Watch while you are wearing it.
- **Mute notifications on phone:** Set to mute the smartphone when it receives notifications that will also be sent to your Watch while you are wearing it.
- **Most recent on phone or watch:** View the apps that received recent notifications and change the notification settings. To customise notification settings for more apps, tap **More** → ▼ → **All** and select an app from the apps list.
- **Sync Do not disturb with phone:** Set to sync the do not disturb settings of your Watch and smartphone.
- **Advanced notification settings:** Configure advanced settings for notifications.

## Sounds and vibration

Change the sound and vibration settings.

On the Galaxy Wearable screen of the smartphone, tap **Watch settings** → **Sounds and vibration**. Refer to [Sounds and vibration](#) in Apps and features for more information.

## Display

Change the screen settings.

On the Galaxy Wearable screen of the smartphone, tap **Watch settings** → **Display**. Refer to [Display](#) in Apps and features for more information.

## Samsung Health

You can set the various setting options related to exercise and fitness.

On the Galaxy Wearable screen of the smartphone, tap **Watch settings** → **Samsung Health**. Refer to [Samsung Health](#) in Apps and features for more information.

## Advanced features

Activate the advanced features.

On the Galaxy Wearable screen of the smartphone, tap **Watch settings** → **Advanced features**. Refer to [Advanced features](#) in Apps and features for more information about other features besides those listed below.

- **Remote connection:** Set the Watch to remotely connect to your smartphone with the mobile network or Wi-Fi network when a Bluetooth connection between devices is unavailable.

## Battery

Check the remaining battery. If the battery is low, activate power saving mode to reduce battery consumption.

On the Galaxy Wearable screen of the smartphone, tap **Watch settings** → **Battery**. Refer to [Battery](#) in Apps and features for more information.

## Apps

Manage the Watch's apps and change their settings.

On the Galaxy Wearable screen of the smartphone, tap **Watch settings** → **Apps**.

- **App settings:** Change the detailed settings for some Watch's app.
- **Your apps:** Manage the Watch's apps and view each app's usage information, or uninstall or disable unnecessary apps.



## Manage content

Transfer saved audio or image files from your smartphone to your Watch manually or automatically and delete audio or image files saved on your Watch on the smartphone.

On the Galaxy Wearable screen of the smartphone, tap **Watch settings** → **Manage content**.

- **Music**

- **Add tracks:** Select audio files and manually send them from the smartphone to the Watch.
- **Delete tracks:** Delete audio files saved on your Watch.
- **Auto sync:** Set the smartphone to automatically sync recently added audio files with the Watch when it has more than 15 % of remaining battery power, when its storage is more than 50 MB, and when power saving mode is deactivated on your Watch.



If the music files saved on the Watch take up more than 1 GB, it deletes files that you have not set as your favourites in order from the music files you first added.

- **Playlists to sync:** Select a playlist to sync with the Watch automatically.



This feature may appear only when the Samsung Music app is installed on your smartphone and when you turn on the **Auto sync** feature.

- **Gallery**

- **Add images:** Select images and manually send them from the smartphone to the Watch.
- **Delete images:** Delete image files saved on your Watch.
- **Auto sync:** Set the smartphone to automatically sync images with the Watch when it has more than 15 % of remaining battery power, when its storage is more than 50 MB, and when power saving mode is deactivated on your Watch.
- **Image limit:** Select the number of images to send to your Watch from a smartphone at one time.
- **Albums to sync:** Select an image album to sync with the Watch automatically.



**Image limit** and **Albums to sync** may appear when you turn on the **Auto sync** feature.

## Mobile plans (SM-R905F, SM-R915F, SM-R925F)

Use various other services through the mobile network after activating it on the Watch.

On the Galaxy Wearable screen of the smartphone, tap **Watch settings** → **Mobile plans**.

## General

Customise your Watch's general settings or reset the Watch.

On the Galaxy Wearable screen of the smartphone, tap **Watch settings** → **General**. Refer to [General](#) in Apps and features for more information.

## Accessibility

Configure various settings to improve accessibility to the Watch.

On the Galaxy Wearable screen of the smartphone, tap **Watch settings** → **Accessibility**. Refer to [Accessibility](#) in Apps and features for more information.

## Safety and emergency

Manage your medical information and emergency contacts. You can also set to request an SOS automatically or manually when you are in emergency situations. Refer to [Sending an SOS](#) for more information.

On the Galaxy Wearable screen of the smartphone, tap **Watch settings** → **Safety and emergency**.

- **Medical info:** Enter your medical information.
- **Send messages to:** Register the emergency contact to send an SOS message.
- **Make SOS call to:** Select a contact to make an emergency call to.
- **SOS with Home key:** Set to request an SOS by quickly pressing the Watch's Home key several times in an emergency.
- **Hard fall detection:** Set to request an SOS automatically when you are hurt from a fall and your Watch recognises it.

## Accounts and backup

Sync your Watch's data using Samsung Cloud, or back up or restore your Watch's data with Samsung Cloud or Smart Switch. You can also register your Samsung or Google account on your connected smartphone and copy it to your Watch.

On the Galaxy Wearable screen of the smartphone, tap **Watch settings** → **Accounts and backup**.



- Regularly back up your data to a safe location, such as Samsung Cloud or a computer, so that you can restore it if the data is corrupted or lost due to an unintended factory data reset.
- Music and images will not be backed up.
- For the Samsung Health app, only records from the previous 28 days are saved in your Watch. To view saved record older than 28 days, install the Samsung Health app on the connected smartphone and back up data automatically.
- **Accounts:** Register your Samsung or Google account on your connected smartphone and copy it to your Watch.
- **Samsung Cloud:** Back up your Watch's data and settings, and restore the previous Watch's data and settings by using Samsung Cloud even when you do not have it. Refer to [Samsung Cloud](#) for more information.
- **Smart Switch:** Back up your Watch's data and settings on the connected smartphone, and restore the previous Watch's data and settings to the new Watch by using Smart Switch. Refer to [Smart Switch](#) for more information.

## Samsung Cloud

Back up your Watch's data to Samsung Cloud and restore it later.

### Backing up data to Samsung Cloud

You can back up your Watch's data to Samsung Cloud.

- 1 On the Galaxy Wearable screen of the smartphone, tap **Watch settings** → **Accounts and backup**.
- 2 Tap **Back up data** under **Samsung Cloud**.
- 3 Tick items you want to back up and tap **Back up**.
- 4 Tap **Done**.

## Restoring data from Samsung Cloud

You can restore your backup data from Samsung Cloud to your Watch.

- 1 On the Galaxy Wearable screen of the smartphone, tap **Watch settings** → **Accounts and backup**.
- 2 Tap **Restore data** under **Samsung Cloud** and select the Watch you want.
- 3 Tick items you want to restore and tap **Restore**.
- 4 Tap **Done**.

## Smart Switch

Back up your Watch's data and settings on the connected smartphone, and restore the previous Watch's data and settings to the new Watch by using Smart Switch.



- This feature may not be supported on some Watches.
- Limitations apply. Visit [www.samsung.com/smartswitch](http://www.samsung.com/smartswitch) for details. Samsung takes copyright seriously. Only transfer content that you own or have the right to transfer.

## Backing up data to the connected smartphone

You can back up your Watch's data to the connected smartphone by using Smart Switch.

- 1 On the Galaxy Wearable screen of the smartphone, tap **Watch settings** → **Accounts and backup**.
- 2 Tap **Back up data** under **Smart Switch**.  
Smart Switch will be launched on your Watch.
- 3 Tick items you want to back up and tap **Back up**.
- 4 Tap **Done**.

## Restoring data from the connected smartphone

You can restore your backup data from the connected smartphone to your new Watch by using Smart Switch.

- 1 On the Galaxy Wearable screen of the smartphone, tap **Watch settings** → **Accounts and backup**.
- 2 Tap **Restore data** under **Smart Switch**.  
Smart Switch will be launched on your Watch.

3 Tick items you want to restore and tap **Restore**.

4 Tap **Done**.

## Watch software update

Update your Watch's software via the firmware over-the-air (FOTA) service. You can also change the update settings.

On the Galaxy Wearable screen of the smartphone, tap **Watch settings** → **Watch software update**. Refer to [Software update](#) for more information.

## About watch

View the Watch's additional information.

On the Galaxy Wearable screen of the smartphone, tap **Watch settings** → **About watch**. Refer to [About watch](#) in Apps and features for more information.

## Find My Watch

Find your lost or misplaced Watch and remotely control it.

On the Galaxy Wearable screen of the smartphone, tap **Find My Watch**.

- **Start:** Check where your Watch is now. Refer to [Find My Watch](#) in Apps and features for more information.
- **Set security:**
  - **Lock watch:** Remotely lock the Watch to prevent unauthorised access. This feature can be used when your smartphone is connected to your Watch via Bluetooth or a remote connection. When your Watch is locked, unlock manually by entering a preset PIN, or connect the Watch to your smartphone via Bluetooth to unlock it automatically.
  - **Reset watch:** Remotely delete all personal information stored in the Watch. After the Watch is reset, you cannot restore the information or use the Find My Watch feature, so it is recommended to back up your data safely by tapping **Back up data**.

## Tips and user manual

View the Watch's basic operations and user manual. You can also use various other services through the mobile network after activating it on the Watch.

On the Galaxy Wearable screen of the smartphone, tap **Tips and user manual**.

## Store

Download the apps and watch faces to be used on your Watch.



On the Galaxy Wearable screen of the smartphone, tap **Store**.

# Usage notices

## Precautions for using the device

Please read this manual when using the device to ensure safe and proper use.

- Descriptions are based on the device's default settings.
- Some content may differ from your device depending on the region, service provider, model specifications, or device's software.
- The device may require a connection to a Wi-Fi or mobile network when using some apps or features.
- Content (high quality content) that requires high CPU and RAM usage will affect the overall performance of the device. Apps related to the content may not work properly depending on the device's specifications and the environment that it is used in.
- Samsung is not liable for performance issues caused by apps supplied by providers other than Samsung.
- Samsung is not liable for performance issues or incompatibilities caused by edited registry settings or modified operating system software. Attempting to customise the operating system may cause the device or apps to work improperly.
- Software, sound sources, wallpapers, images, and other media provided with this device are licensed for limited use. Extracting and using these materials for commercial or other purposes is an infringement of copyright laws. Users are entirely responsible for illegal use of media.
- You may incur additional charges for data services, such as messaging, uploading and downloading, auto-syncing, or using location services depending on your data plan. For large data transfers, it is recommended to use the Wi-Fi feature.
- Default apps that come with the device are subject to updates and may no longer be supported without prior notice.
- This device's operating system is different from some previous series of the Galaxy Watch, and you cannot use previously purchased content due to the compatibility issues.
- The model specifications and supported services may differ depending on the region.



- Modifying the device's operating system or installing software from unofficial sources may result in device malfunctions and data corruption or loss. These actions are violations of your Samsung licence agreement and will void your warranty.
- Some functions may not work as described in this manual depending on the maker and model of the smartphone you connect to your Watch.
- You can see the touchscreen clearly even in strong outdoor sunlight by automatically adjusting the contrast range based on the surrounding environment. Due to the nature of the product, displaying fixed graphics for extended periods may result in afterimages (screen burn-in) or ghosting.
  - It is recommended not to use fixed graphics on part or all of the touchscreen for extended periods and turn off the touchscreen when not using the device.
  - You can set the touchscreen to turn off automatically when you are not using it. On the Watch's Apps screen, tap  (**Settings**) → **Display** → **Screen timeout**, and then select the length of time you want the device to wait before turning off the touchscreen.
  - To set the touchscreen to automatically adjust its brightness based on the surrounding environment, on the Watch's Apps screen, tap  (**Settings**) → **Display**, and then tap the **Auto brightness** switch to activate it.
- Depending on the region or model, some devices are required to receive approval from the Federal Communications Commission (FCC).

If your device is approved by the FCC, you can view the FCC ID of the Watch. To view the FCC ID, on the Watch's Apps screen, tap  (**Settings**) → **About watch** → **Status info**. If your device does not have an FCC ID, it means that the device has not been authorised for sale in the U.S. or its territories and may only be brought to the U.S. for the owner's personal use.

- Depending on the region, you can view the regulatory information on the device. To view the information, on the Watch's Apps screen, tap  (**Settings**) → **About watch** → **Regulatory info**.
- Your device contains magnets. Keep it away from credit cards, implanted medical devices, and other devices that may be affected by magnets. In the case of medical devices, keep your device more than 15 cm apart. Stop using your device if you suspect any interference with your medical device and consult your physician or your medical device manufacturer.



## Instructional icons

-  **Warning:** situations that could cause injury to yourself or others
-  **Caution:** situations that could cause damage to your device or other equipment
-  **Notice:** notes, usage tips, or additional information

## Notes on package contents and accessories

Refer to the quick start guide for package contents.

- The items supplied with the Watch and any available accessories may vary depending on the region or service provider.
- The supplied items are designed only for this Watch and may not be compatible with other devices.
- Appearances and specifications are subject to change without prior notice.
- You can purchase additional accessories from your local Samsung retailer. Make sure they are compatible with the Watch before purchase.
- Except for the Watch, some supplied items and accessories may not have the same water- and dust-resistance certification.
- Use only Samsung-approved accessories. Using unapproved accessories may cause the performance problems and malfunctions that are not covered by the warranty.
- Availability of all accessories is subject to change depending entirely on manufacturing companies. For more information about available accessories, refer to the Samsung website.

## Maintaining the device's water and dust resistance

- This device is water and dust resistant, and meets the following international standards.
  - 5ATM water resistance classification certification: Was tested by submerging the device in 50 m of fresh water for 10 minutes, leaving it still, without any movement, to meet the requirements of ISO 22810:2010.
  - IPX8 water resistance classification certification: Was tested by submerging the device in 1.5 m of fresh water for 30 minutes, leaving it still, without any movement, to meet the requirements of IEC 60529.
  - IP6X dust resistance classification certification: Was tested to meet the requirements of IEC 60529.
- You can use this device when you are exercising, washing your hands or on a rainy day.
- You can use this device when you are swimming in a pool or the sea where the water level is not deep.
- The water resistance of your Galaxy device is not permanent and may diminish over time. We recommend that you have your Galaxy device's water resistance tested once a year at a Samsung Service Centre or an authorised service centre.
- You must follow the guidelines below to maintain the water and dust resistance of your device.
  - After swimming, and before the pool water or seawater has dried, rinse the device with fresh water and dry it thoroughly with a soft, clean cloth to maintain its water resistance. The water resistance may be affected by the disinfectants in swimming pool water or the salt in seawater.
  - If the device gets wet with liquid other than fresh water, such as coffee, drinks, soapy water, oil, perfume, sunscreen, hand sanitiser, or chemical products like cosmetics, rinse the device with fresh water and dry it thoroughly with a soft, clean cloth to maintain its water resistance.

- Do not stay submerged underwater, go snorkeling, diving or scuba diving, or play water sports like water-skiing or surfing, and do not swim in fast-moving water, such as a river, while wearing your device. Also, do not expose it to high-pressure cleaning machines or similar things. This would result in a dramatic rise in water pressure which could cause the water resistance guaranteed by our company to change.
- If the device is hit or damaged, its water and dust resistance may be compromised.
- Do not disassemble your device without proper guidance.
- If you dry your device with a machine that gives off hot air, like a hair dryer, or if you use your device in a hot environment like a sauna, the water resistance could be damaged from a dramatic change in the air or water temperature.

## Precautions for overheating

If you feel discomfort due to overheating while using the device, stop using it immediately and remove it from your wrist.

To avoid problems, such as device malfunction, skin discomfort or damage, and battery draining, a warning will appear on the device if it reaches a specific temperature. When the initial warning appears, device functions will be disabled until the device cools down to a specific temperature. However, the emergency call feature will be available on the LTE model.

If the device temperature continues to increase, a second warning will appear. At this time, the device will shut down. Do not use the device until it cools down to a specific temperature. However, when using the LTE model, the emergency call feature that has been previously connected will remain active until you are finished, even though the second warning will appear.

## Cleaning and managing the Watch

Follow the points below to ensure your Watch functions correctly and maintains its appearance. Failure to do so may damage the Watch and cause the skin irritation.

- Turn off the Watch and remove the band before cleaning it.
- Prevent the device from being exposed to dust, sweat, ink, oil, and chemical products such as cosmetics, antibacterial spray, hand cleaner, detergent, and insecticides. The Watch's exterior and interior parts may be damaged or it could result in poor performance. If your Watch is exposed to any of the previously mentioned substances, use a lint-free, soft cloth to clean it.
- Do not use soap, cleaning agents, abrasive materials and compressed air when cleaning your Watch and do not clean it with the ultrasonic waves or the external heat sources. Doing so may damage the Watch. Skin irritation may be caused by soap, detergents, hand sanitisers, or cleaning agents left on the Watch.
- When you remove sun block, lotion, or oil, use a soap-free detergent, then rinse and dry your Watch thoroughly.



The supplied band may vary depending on the region or model. Be sure to properly clean and maintain your band accordingly.

## Use caution if you are allergic to any materials on the Watch

- Samsung has tested the noxious materials found on the Watch through the internal and external certificate authorities, including the test for all materials which contact with skin, skin toxicity test, and the Watch-wearing test.
- The Watch includes nickel. Take the necessary precautions if your skin is hypersensitive or you have an allergy to any materials found on the Watch.
  - **Nickel:** The Watch contains a small amount of nickel, which is below its reference point limited by the Europe REACH regulation. You will not be exposed to the nickel inside the Watch and the Watch has passed the international certificated test. However, if you are sensitive to nickel, be careful to use the Watch.
- Only the materials observed the standards of the U.S Consumer Product Safety Commission (CPSC), the regulations of the European countries, and other international standards are used to make a Watch.
- For more information about how Samsung manages chemicals, refer to the Samsung website (<https://www.samsung.com/uk/aboutsamsung/sustainability/environment/>, <https://www.samsung.com/au/support/newsalert/119791/>).

# Appendix

## Troubleshooting

Before contacting a Samsung Service Centre or an authorised service centre, please attempt the following solutions. Some situations may not apply to your Watch.

You can also use Samsung Members to solve any problems you might encounter while using your device.

### The quick panel displays network or service error messages

- When you are in areas with weak signals or poor reception, you may lose reception. Move to another area and try again. While moving, error messages may appear repeatedly.
- You cannot access some options without a subscription. For more information, contact your service provider.

### Your Watch does not turn on

When the battery is completely discharged, your Watch will not turn on. Fully charge the battery before turning on the Watch.

### The touchscreen responds slowly or improperly

- If you attach a screen protector or optional accessories to the touchscreen, the touchscreen may not function properly.
- If you are wearing gloves, if your hands are not clean while touching the touchscreen, or if you tap the screen with sharp objects or your fingertips, the touchscreen may malfunction.
- The touchscreen may malfunction in humid conditions or when exposed to water.
- Restart your Watch to clear any temporary software bugs.
- Ensure that your Watch software is updated to the latest version.
- If the screen is scratched or damaged, visit a Samsung Service Centre or an authorised service centre.

## Your Watch freezes or has errors

Try the following solutions. If the problem is still not resolved, contact a Samsung Service Centre or an authorised service centre.

### Restarting the Watch

If your Watch freezes or hangs, you may need to close apps or turn off the Watch and turn it on again.

### Forcing restart

If your Watch is frozen and unresponsive, press and hold the Home key and the Back key simultaneously for more than 7 seconds to restart it.

### Resetting the Watch

If the methods above do not solve your problem, perform a factory data reset.

On the Apps screen, tap  (Settings) → **General** → **Reset** → **Reset**. Alternatively, launch the **Galaxy Wearable** app on your smartphone and tap **Watch settings** → **General** → **Reset** → **Reset**. Before performing the factory data reset, remember to make backup copies of all important data stored in the Watch.

## Another Bluetooth device cannot locate your Watch

- Ensure that the Bluetooth wireless feature is activated on your Watch.
- Reset your Watch and try again.
- Ensure that your Watch and the other Bluetooth device are within the Bluetooth connection range (10 m). The distance may vary depending on the environment the devices are used in.

If the tips above do not solve the problem, contact a Samsung Service Centre or an authorised service centre.

## A Bluetooth connection is not established or your Watch and the smartphone are disconnected

- Ensure that the Bluetooth feature on both devices is activated.
- Ensure there are no obstacles, such as walls or electrical equipment, between the devices.
- Ensure that the latest version of the Galaxy Wearable app is installed on the smartphone. If necessary, update the Galaxy Wearable app to the latest version.
- Ensure that your Watch and the other Bluetooth device are within the Bluetooth connection range (10 m). The distance may vary depending on the environment the devices are used in.
- Restart both devices and launch the **Galaxy Wearable** app on the smartphone again.

## Calls are not connected

- Ensure that your Watch is connected to a smartphone via Bluetooth.
- Ensure that your smartphone and Watch have accessed the right cellular network.
- Ensure that you have not set call barring for the phone number you are dialling on the smartphone.
- Ensure that you have not set call barring for the incoming phone number on the smartphone.
- Check if do not disturb mode, theatre mode, or bedtime mode is activated. If one of these modes has been activated, incoming calls will be muted and the screen will not turn on when receiving incoming calls. Tap the screen or press the key to turn on the screen and check the incoming call.

## Others cannot hear you speaking on a call

- Ensure that you are not covering the built-in microphone.
- Ensure that the microphone is close to your mouth.
- If using a Bluetooth headset, ensure that it is properly connected.



## Sound echoes during a call

Adjust the volume or move to another area.

## A cellular network or the Internet is often disconnected or audio quality is poor

- Ensure that you are not blocking the Watch's internal antenna.
- When you are in areas with weak signals or poor reception, you may lose reception. You may have connectivity problems due to issues with the service provider's base station. Move to another area and try again.
- When using the device while moving, wireless network services may be disabled due to issues with the service provider's network.

## The battery does not charge properly (For Samsung-approved chargers)

- Ensure that you connect the Watch to the wireless charger properly.
- Visit a Samsung Service Centre or an authorised service centre and have the battery replaced.

## The battery depletes faster than when first purchased

- When you expose the Watch or the battery to very cold or very hot temperatures, the useful charge may be reduced.
- Battery consumption increases when you use some apps.
- The battery is consumable and the useful charge will get shorter over time.

## Your Watch is hot to the touch

When you use apps that require more power or use apps on your Watch for an extended period of time, your Watch may feel hot to the touch. This is normal and should not affect your Watch's lifespan or performance.

If the Watch overheats or feels hot for a prolonged period, do not use it for a while. If the Watch continues to overheat, contact a Samsung Service Centre or an authorised service centre.

## Your Watch cannot find your current location

The Watch uses your smartphone's location information. GPS signals may be obstructed in some locations, such as indoors. Set to use Wi-Fi or a mobile network to find your current location.

## Data stored in the Watch has been lost

Always make backup copies of all important data stored in the Watch. Otherwise, you cannot restore data if it is corrupted or lost. Samsung is not responsible for the loss of data stored in the Watch.

## A small gap appears around the outside of the Watch case

- This gap is a necessary manufacturing feature and some minor rocking or vibration of parts may occur.
- Over time, friction between parts may cause this gap to expand slightly.

## There is not enough space in the Watch's storage

Delete unused apps or files to free up storage space.

## Removing the battery

- **To remove the battery, contact an authorised service centre. To obtain battery removal instructions, please visit [www.samsung.com/global/ecodesign\\_energy](http://www.samsung.com/global/ecodesign_energy).**
- For your safety, you **must not attempt to remove** the battery. If the battery is not properly removed, it may lead to damage to the battery and device, cause personal injury, and/or result in the device being unsafe.
- Samsung does not accept liability for any damage or loss (whether in contract or tort, including negligence) which may arise from failure to precisely follow these warnings and instructions, other than death or personal injury caused by Samsung's negligence.

## Copyright

Copyright © 2022 Samsung Electronics Co., Ltd.

This manual is protected under international copyright laws.

No part of this manual may be reproduced, distributed, translated, or transmitted in any form or by any means, electronic or mechanical, including photocopying, recording, or storing in any information storage and retrieval system.

## Trademarks

- SAMSUNG and the SAMSUNG logo are registered trademarks of Samsung Electronics Co., Ltd.
- Bluetooth® is a registered trademark of Bluetooth SIG, Inc. worldwide.
- Wi-Fi®, Wi-Fi Direct™, Wi-Fi CERTIFIED™, and the Wi-Fi logo are registered trademarks of the Wi-Fi Alliance.
- All other trademarks and copyrights are the property of their respective owners.