



by Schneider Electric

# User Manual Back-UPS

BX Series 500VA, 750VA, 950VA, 1200VA, 1600VA, 2200VA

## IMPORTANT SAFETY INSTRUCTIONS

Read the instructions carefully and look at the equipment to become familiar with the device before trying to install, operate, service or maintain it. The following special messages may appear throughout this document or on the equipment to warn of potential hazards or to call attention to information that clarifies or simplifies a procedure.



The addition of this symbol to either a “Danger” or “Warning” safety label indicates that an electrical hazard exists which will result in personal injury if the instructions are not followed.



This is the safety alert symbol. It is used to alert you to potential personal injury hazards. Obey all safety messages that follow this symbol to avoid possible injury or death.

### DANGER

**DANGER** indicates a hazardous situation which, if not avoided, will result in death or serious injury.

### WARNING

**WARNING** indicates a hazardous situation which, if not avoided, **could result in** death or serious injury.

### CAUTION

**CAUTION** indicates a hazardous situation which, if not avoided, **could result in** minor or moderate injury.

### NOTICE

**NOTICE** is used to address practices not related to physical injury.

## Product Handling Guidelines



< 18 kg  
< 40 lb



18-32 kg  
40-70 lb



32-55 kg  
70-120 lb



> 55 kg  
> 120 lb



# Safety and General Information

## SAVE THESE INSTRUCTIONS –

This manual contains important instructions that should be followed during installation and maintenance of the UPS and batteries.

Inspect the package contents upon receipt. Notify the carrier and dealer if there is any damages.

- This UPS is intended for indoor use only.
- Mains socket outlet that supplies the UPS shall be installed near the UPS and shall be easily accessible.
- UPS must be connected to an earthed mains socket outlet.
- Servicing of batteries should be performed or supervised by personnel knowledgeable about batteries and required precautions. In this case, batteries is not user-replaceable.
- When replacing battery the UPS must be OFF, and its AC inlet unplugged.
- **CAUTION** Do not dispose of batteries in a fire. The batteries may explode.
- **CAUTION** Risk of explosion if battery is replaced by an incorrect type. Dispose of used batteries according to the instructions.
- Do not open or mutilate batteries. They contain an electrolyte that is toxic and harmful to the skin and eyes.
- Failed batteries can reach temperatures that exceed the burn thresholds for touchable surfaces.
- **CAUTION** A battery can present a risk of electrical shock and high short circuit current.

The following precautions should be observed when working on batteries.

- a. Remove watches, rings or other metal objects.
- b. Use tools with insulated handles.
- c. Wear rubber gloves and boots.
- d. Do not lay tools or metal parts on top of batteries.
- e. Disconnect the charging source prior to connecting or disconnecting battery terminals.
- f. Determine if battery is inadvertently grounded. If inadvertently grounded, remove source from ground. Contact with any part of a grounded battery can result in electrical shock. The likelihood of such shock can be reduced if such grounds are removed during installation and maintenance.

## Radio Frequency Warning

This is a category C2 UPS product. In a residential environment, this product may cause radio interference, in which case the user may be required to take additional measures.

## Product Description

The APC by Schneider Electric Back-UPS offers power and surge protection for wireless networks, computers, gaming consoles and other electronics in your home or business. This UPS supply battery backup during outages and unstable voltage fluctuations, as well as provide protection from damaging surges and spikes. It's equipped with data line surge protection which safeguards your equipment and valuable files from “back door” surges traveling along data line. They are the choice helps to protect your sensitive electronics.

## Place and Power On

1. Place the Back-UPS to avoid:

- Direct sunlight
- Excessive heat
- Excessive moisture
- Excessive dust/dirt



For operation, please place the unit on the floor.

2. Connect the battery by pulling the battery handle up, and then pushing it into the unit.

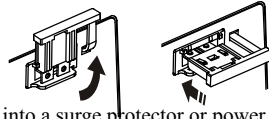

3. Connect equipment to the UPS. Avoid using extension cords.

4. Plug the Back-UPS power cord directly into a wall outlet, not into a surge protector or power strip.

5. Press the ON/OFF button to turn on the unit.

The green “Power On” indicator confirms that the Back-UPS is on and ready to provide protection.

The Back-UPS should charge for at least 24 hours to ensure sufficient runtime. The unit is being charged whenever it is connected to AC power, whether the unit is turned ON or OFF.

# Operational Features

## Automatic Voltage Regulation (AVR)

Automatic Voltage Regulation boosts/trims the AC voltage when it drops/exceeds levels. This allows the equipment plugged into the unit to operate during low/high voltage conditions, conserving the battery power in the event of a power cut. The Back-UPS will switch to battery power if the input voltage level becomes too low/high for the Automatic Voltage Regulation to compensate, or if the AC power is distorted.

## PowerChute™ Personal Edition Software

To install PowerChute Personal Edition (PCPE) software, connect a USB cable to the data port on the UPS and the other end to a computer with access to the web. On the computer, go to [www.apc.com/tools/download](http://www.apc.com/tools/download). Select “**Software Upgrades - PowerChute Personal Edition**” in the “**Filter by Software/Firmware**” drop down menu. Select the appropriate operating system. Follow directions to download the software.

## Quick Mute

The Back-UPS is able to temporarily mute user correctable audible alarms such as On Battery. During such audible alarms, a short press of the POWER button will temporarily mute the audible alarm until the condition has been reset. A short double beep will confirm that Quick Mute has been activated. Pressing the POWER button for more than 2 seconds will turn off the UPS. Other critical events such as Battery replacement and Charger notification can not be temporarily muted. The unit in these cases must be turned off.

## Voltage Sensitivity Adjustment

Ensure the Back-UPS is off. Press and hold the POWER button for 10 seconds until a beep is heard. The LED will flash and sensitivity LOW is set. If press and hold the POWER button for 10 seconds again, the LED will be on and sensitivity MEDIUM is set.

LED status	Sensitivity Setting	Input Voltage Range	Recommended Use
Flash	LOW	140 Vac to 300 Vac	Use this setting with equipment that is less sensitive to fluctuations in voltage or waveform distortions.
On	MEDIUM	145 Vac to 295 Vac	Factory default setting. Use this setting under normal conditions

## LED Brightness Setting

The Back-UPS is able to control LED brightness. During On Line Mode, a short press of the POWER button will dim the LED brightness and heard a beep. Press one more time, the LED brightness will return again.

## Self-Test

The Back-UPS will perform an automatic test of the internal battery when UPS is turned on or UPS operates in On Line Mode for 14 days. During On Line Mode, a longer press of the POWER button until three beeps are heard will perform a manual battery self-test. Then, the LED will flash and UPS will enter self-test mode.

Note: This will happen only when battery is fully charged in On-Line Mode.

# Battery Replacement

## CAUTION

### **RISK OF HYDROGEN SULPHIDE GAS AND EXCESSIVE SMOKE**

- Replace the battery at least every 5 years or at the end of its service life, whichever is earlier.
- Replace the battery immediately when the UPS indicates battery replacement is necessary.
- Replace batteries with the same number and type of batteries as originally installed in the equipment.
- Replace the battery immediately when the UPS indicates a battery over-temperature condition or when there is evidence of electrolyte leakage. Power off the UPS, unplug it from the AC input, and disconnect the batteries. Do not operate the UPS until the batteries have been replaced.













**Failure to follow these instructions can result in minor or moderate injury and equipment damage.**

The battery in the Back-UPS is not user-replaceable. Contact SEIT Technical Support for a list of authorized service centers near you.





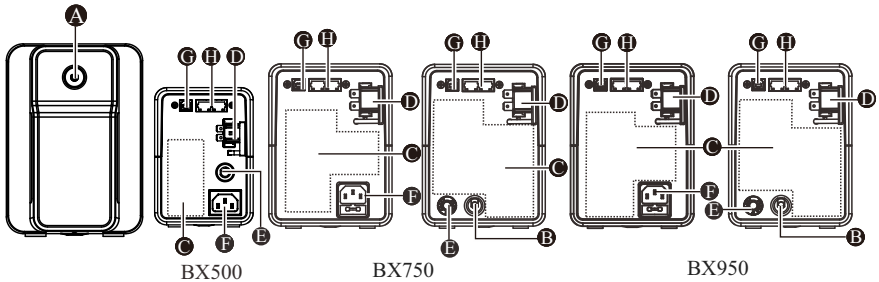

For the recycling battery information, please go to [apc.com/recycle](http://apc.com/recycle).

# Features

- A** ON/OFF button with indicator
- B** Input power cord
- C** Battery backup and surge protected outlets
- D** Battery connector
- E** Circuit breaker
- F** AC power inlet with AC fuse  
\*only for model with IEC socket
- G** USB data port
- H** In/Out Ethernet surge-protected ports

Model	BX750MI-GR BX950MI-GR	BX750MI-AZ	BX950MI-AZ	BX750MI-MS	BX950MI-MS
Output Type and Quantity	 x 4	 x 3	 x 4	 x 2  x 1	 x 2  x 2
Model	BX500MI	BX750MI	BX950MI	BX750MI-FR	BX950MI-FR
Output Type and Quantity	 x 3	 x 4	 x 6	 x 3	 x 4



Model	BX1200MI BX1600MI BX2200MI	BX1200MI-GR BX1600MI-GR BX2200MI-GR	BX1200MI-FR BX1600MI-FR BX2200MI-FR	BX1600MI-MS BX2200MI-MS	BX1200MI-AR/AZ BX1600MI-AR/AZ BX2200MI-AR
Output Type and Quantity	 x 6	 x 4	 x 4	 x 4	 x 4
Model	BX1200MI-MS				
Output Type and Quantity	 x 4  x 1				

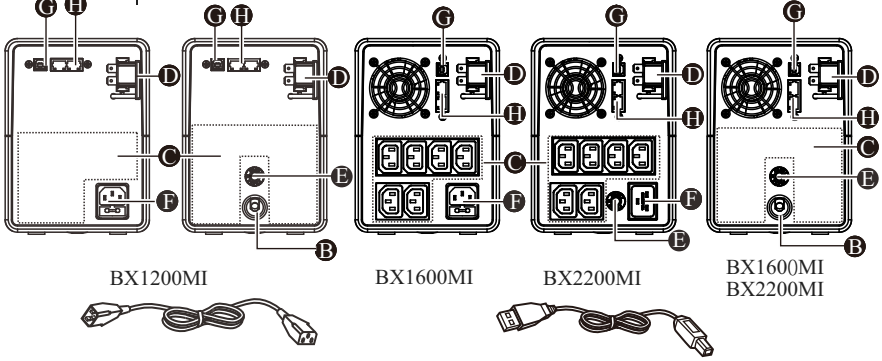

IEC jumper Cable for PC connection(1.2m)  
\*only for the model with IEC outlet

USB communication cable (1.2m)

# Specifications

Model		BX500MI	BX750MI	BX950MI	BX1200MI	BX1600MI	BX2200MI
<b>Input</b>	Voltage	220-240 Vac					
	Frequency	50 Hz or 60 Hz (auto-sensing)					
	Brownout Transfer	140 Vac, typical					
	Over-voltage Transfer	300 Vac, typical					
<b>Output</b>	UPS Capacity (total)	500VA/ 300W	750VA/ 410W	950VA/ 520W	1200VA/ 650W	1600VA/ 900W	2200VA/ 1200W
	Voltage On Battery	230 Vac $\pm$ 10%					
	Frequency - On Battery	50 Hz / 60 Hz $\pm$ 0.5Hz					
	Transfer Time	6ms typical, 10ms max.					
<b>Protection</b>	AC Input Circuit Breaker	5A/ 250Vac	5A/ 250Vac	7A/ 250Vac	10A/ 250Vac	12A/ 250Vac	15A/ 250Vac
	AC Input Fuse		T 5A L 250Vac	T 8A L 250Vac	T 10A L 250Vac	T 12A L 250Vac	T 15A L 250Vac
<b>Battery</b>	Type (maintenance-free)	12V, 7AH x 1 lead acid	12V, 9AH x 1 lead acid	12V, 9AH x 1 lead acid	12V, 9AH x 1 lead acid	12V, 7AH x 2 lead acid	12V, 9AH x 2 lead acid
	Average Life	<p>The battery typically lasts for three to five years. Environmental factors impact battery backup life. Elevated temperatures, high humidity, poor quality mains power, and frequent, short duration discharges will shorten battery life.</p> <p>The battery in the Back-UPS Series is not user-replaceable. Contact SEIT Technical Support for a list of authorized service centers near you.</p>					
	Typical Recharge Time	8 hours to 90% capacity					
<b>Physical</b>	Net Weight	4.2 kg	5.4 kg	6.1 kg	7.6 kg	10.3 kg	12.3 kg
	Dimensions (Hx Wx D) cm	13.8 x 9.8 x 31	16 x 12 x 35.5		19 x 14 x 39		
	Shipping Weight	4.5 kg	5.9 kg	6.6 kg	8.6 kg	11.3 kg	13.3 kg
	Shipping Dimensions (H x W x D) cm	22.2 x 14.2 x 34.6	25 x 19.7 x 43		29.7 x 23.5 x 49.5		
<b>Temperature</b>	Operating	0 °C to 40 °C					
<b>International Protection Code</b>		IP20					

\* The length of input power cord is 1.2m. For best operation, do not use output cable longer than 2m.

\*\* The length of USB communication cable is 1.2m. For best operation, do not use communication cable longer than 3m.

# Status Indicators

LED	Audible Alarm	Condition
<b>On</b>	Off	<b>On-line</b> - The Back-UPS is supplying AC power to the connected equipment
	Constant Tone	<b>On Line Overload</b> - The power being used by the connected equipment has exceeded the capacity of the unit. Disconnect some equipment.
	Constant beeping (every 1/2 second)	<b>Over-temperature Detected</b> - The unit is overheating and will operate in AVR mode for 1 minute. The Back-UPS will shut down if the temperature is not lowered. Disconnect some of the connected equipment.
<b>On</b> (Off during 4 beeps)	4 beeps repeated every 30 seconds	<b>On-Battery</b> - The Back-UPS is supplying battery power.
<b>Flashing</b>	Constant beeping (every 1/2 second)	<b>Low Battery</b> - The Back-UPS is supplying battery power and the battery is near a total discharge state.
	Constant tone	<b>Replace Battery Detected</b> - The battery needs to be charged, or is at end of life. <b>Note:</b> - If the battery is disconnected, unplug the Back-UPS from AC source and then turn it off. Refer to the section "Place and Power On" on page 3. - If battery needs replacement, refer to the section "Battery Replacement" on page 2 for details.
<b>Off</b>	Short beep every 4 seconds	<b>Low Battery Shutdown</b> - During On Battery operation the battery power was almost completely exhausted, and the Back-UPS is waiting for AC power to return to normal.
	Constant Tone	<b>On Line Overload Fault</b> - The connected equipment requires more power than provided by the Back-UPS. Unplug devices one at a time to remove overload.  If the detected problem is not corrected, contact SEIT Technical Support
		<b>Charger Detected Fault</b> - Back-UPS has an internal problem detected, and is no longer powering the load. Contact SEIT Technical Support
	Long beep every 4 seconds	<b>Over-temperature Detected Fault</b> - The Back-UPS has overheated and has shut down. Unplug connected devices one at a time or wait for a few hours for system to cool down.

# Troubleshooting

Detected Problem and Possible Cause	Solution
<b>The Back-UPS will not turn on</b>	
The Back-UPS has not been turned on.	Press the ON/OFF button.
The Back-UPS is not connected to AC power, there is no AC power available at the wall outlet, or the AC power is experiencing a brownout or over voltage condition.	Make sure the power cord is securely connected to the wall outlet, and that there is AC power available at the wall outlet. Where applicable, check that the wall outlet is switched on.
The battery is disconnected.	Refer to the “ <i>Place and Power On</i> ” on page 3.
<b>Connected equipment loses power</b>	
A Back-UPS overload condition has occurred.	Remove all nonessential equipment connected to the outlets. One at a time reconnect equipment to the Back-UPS. Charge the battery for 24 hours to make sure it is fully charged. If the overload condition still occurs, replace the battery.
The Back-UPS battery is completely discharged.	Connect the Back-UPS to AC power and allow the battery to recharge for ten hours.
Connected equipment does not accept the step-approximated sine waveform from the Back-UPS.	The output waveform is intended for computers and peripheral devices. It is not intended for use with motor driven equipment.
The Back-UPS may require service.	Contact Schneider Electric Technical Support for more in depth troubleshooting
<b>The ON/OFF button is green and flashing every 30 seconds. 4 beeps repeated every 30 seconds.</b>	
The Back-UPS is operating on battery power.	The Back-UPS is operating normally on battery power. At this point the user should save all open files, and shutdown the computer. When AC power is restored the battery will recharge.
<b>The ON/OFF button flashes green and constant beeps every 1/2 second.</b>	
The Back-UPS battery has approximately empty and will shutdown	The Back-UPS battery is near a total discharge state. At this point the user should save all open files, and shutdown the computer. When AC power is restored the battery will recharge.
<b>The Back-UPS has an inadequate battery runtime</b>	
The battery is not fully charged. The battery is near the end of useful life and should be replaced.	Leave the Back-UPS connected to AC power for ten hours while the battery charges to full capacity. As a battery ages, the runtime capability decreases.
<b>The UPS and outlets are off but the UPS keeps beeping once every 4 seconds. The audible alarm will mute after 32 seconds.</b>	
The UPS have shut down due to low battery, but control power exists.	The UPS will return to normal operation once the AC input voltage has returned to a normal range.



# Service

If the unit requires service, do not return it to the dealer. Follow these steps:

1. Review the Troubleshooting section of the manual to eliminate common problems.
2. If the problem persists, contact Schneider Electric IT (SEIT) Customer Support through the APC by Schneider Electric website, **www.apc.com**.
  - a. Note the model number and serial number and the date of purchase. The model and serial numbers are located on the rear panel of the unit.
  - b. Call SEIT Customer Support and a technician will attempt to solve the problem over the phone. If this is not possible, the technician will issue a Returned Material Authorization Number (RMA#).
  - c. If the unit is under warranty, the repairs are free.
  - d. Service procedures and returns may vary internationally. Refer to the APC by Schneider Electric website for country specific instructions.
3. Pack the unit in the original packaging whenever possible to avoid damage in transit. Never use foam beads for packaging. Damage sustained in transit is not covered under warranty.
4. **Always DISCONNECT THE UPS BATTERIES before shipping. The United States Department of Transportation (DOT), and the International Air Transport Association (IATA) regulations require that UPS batteries be disconnected before shipping.** The internal batteries may remain in the UPS.
5. Write the RMA# provided by Customer Support on the outside of the package.
6. Return the unit by insured, pre-paid carrier to the address provided by Customer Support

# Warranty

## Register your product on-line. <http://warranty.apc.com>

The standard warranty is two (2) years from the date of purchase. SEIT standard procedure is to replace the original unit with a factory reconditioned unit. Customers who must have the original unit back due to the assignment of asset tags and set depreciation schedules must declare such a need at first contact with an SEIT Technical Support representative. SEIT will ship the replacement unit once the defective unit has been received by the repair department, or cross-ship upon the receipt of a valid credit card number. The customer pays for shipping the unit to SEIT. SEIT pays ground freight transportation costs to ship the replacement unit to the customer.

## APC by Schneider Electric IT Customer Support Worldwide

For country specific customer support, go to the APC by Schneider Electric website, **www.apc.com**.