

ASUS[®]

**PA148CTV Series
LCD Monitor**

User Guide

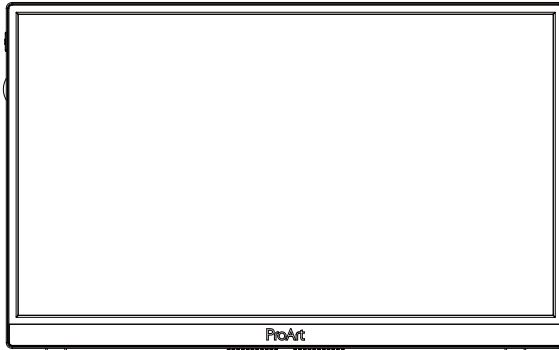

HDMI[™]
HIGH-DEFINITION MULTIMEDIA INTERFACE

Table of contents

Notices	iii
Safety information	v
Care & Cleaning	vii
1.1 Welcome!	1-1
1.2 Package contents.....	1-1
1.3 Connect cables.....	1-2
1.4 Monitor introduction	1-3
1.4.1 Using the Controls button	1-3
2.1 Adjusting the monitor.....	2-1
3.1 OSD (On-Screen Display) menu	3-1
3.1.1 How to reconfigure.....	3-1
3.1.2 OSD Function Introduction.....	3-2
3.2 Specifications.....	3-10
3.3 Troubleshooting (FAQ).....	3-11
3.4 Supported Timing List.....	3-12

Copyright © 2020 ASUSTeK COMPUTER INC. All Rights Reserved.

No part of this manual, including the products and software described in it, may be reproduced, transmitted, transcribed, stored in a retrieval system, or translated into any language in any form or by any means, except documentation kept by the purchaser for backup purposes, without the express written permission of ASUSTeK COMPUTER INC. ("ASUS").

Product warranty or service will not be extended if: (1) the product is repaired, modified or altered, unless such repair, modification or alteration is authorized in writing by ASUS; or (2) the serial number of the product is defaced or missing.

ASUS PROVIDES THIS MANUAL "AS IS" WITHOUT WARRANTY OF ANY KIND, EITHER EXPRESS OR IMPLIED, INCLUDING BUT NOT LIMITED TO THE IMPLIED WARRANTIES OR CONDITIONS OF MERCHANTABILITY OR FITNESS FOR A PARTICULAR PURPOSE. IN NO EVENT SHALL ASUS, ITS DIRECTORS, OFFICERS, EMPLOYEES OR AGENTS BE LIABLE FOR ANY INDIRECT, SPECIAL, INCIDENTAL, OR CONSEQUENTIAL DAMAGES (INCLUDING DAMAGES FOR LOSS OF PROFITS, LOSS OF BUSINESS, LOSS OF USE OR DATA, INTERRUPTION OF BUSINESS AND THE LIKE), EVEN IF ASUS HAS BEEN ADVISED OF THE POSSIBILITY OF SUCH DAMAGES ARISING FROM ANY DEFECT OR ERROR IN THIS MANUAL OR PRODUCT.

SPECIFICATIONS AND INFORMATION CONTAINED IN THIS MANUAL ARE FURNISHED FOR INFORMATIONAL USE ONLY, AND ARE SUBJECT TO CHANGE AT ANY TIME WITHOUT NOTICE, AND SHOULD NOT BE CONSTRUED AS A COMMITMENT BY ASUS. ASUS ASSUMES NO RESPONSIBILITY OR LIABILITY FOR ANY ERRORS OR INACCURACIES THAT MAY APPEAR IN THIS MANUAL, INCLUDING THE PRODUCTS AND SOFTWARE DESCRIBED IN IT.

Products and corporate names appearing in this manual may or may not be registered trademarks or copyrights of their respective companies, and are used only for identification or explanation and to the owners' benefit, without intent to infringe.

Notices

Federal Communications Commission Statement

This device complies with Part 15 of the FCC Rules. Operation is subject to the following two conditions:

- This device may not cause harmful interference, and
- This device must accept any interference received including interference that may cause undesired operation.

This equipment has been tested and found to comply with the limits for a Class B digital device, pursuant to Part 15 of the FCC Rules. These limits are designed to provide reasonable protection against harmful interference in a residential installation. This equipment generates, uses and can radiate radio frequency energy and, if not installed and used in accordance with manufacturer's instructions, may cause harmful interference to radio communications. However, there is no guarantee that interference will not occur in a particular installation. If this equipment does cause harmful interference to radio or television reception, which can be determined by turning the equipment off and on, the user is encouraged to try to correct the interference by one or more of the following measures:

- Reorient or relocate the receiving antenna.
- Increase the separation between the equipment and receiver.
- Connect the equipment to an outlet on a circuit different from that to which the receiver is connected.
- Consult the dealer or an experienced radio/TV technician for help.



NOTE: This monitor is ENERGY STAR certified.

This product qualifies for ENERGY STAR® in the factory default (Home configuration) setting. Changing the factory default settings or enabling other features may increase power consumption that could exceed the limits necessary to qualify for ENERGY STAR®. Refer to ENERGYSTAR.gov (www.energystar.gov) for more information on the ENERGY STAR® program.

Canadian Department of Communications Statement

This digital apparatus does not exceed the Class B limits for radio noise emissions from digital apparatus set out in the Radio Interference Regulations of the Canadian Department of Communications.

This class B digital apparatus complies with Canadian ICES-003.

The device may fall, causing serious personal injury or death. To prevent injury, this device must be securely attached to the floor/wall in accordance with the installation instructions.



Safety information

- Before setting up the monitor, carefully read all the documentation that came with the package.
- To prevent fire or shock hazard, never expose the monitor to rain or moisture.
- Never try to open the monitor cabinet. The dangerous high voltages inside the monitor may result in serious physical injury.
- If the power supply is broken, do not try to fix it by yourself. Contact a qualified service technician or your retailer.
- Before using the product, make sure all cables are correctly connected and the power cables are not damaged. If you detect any damage, contact your dealer immediately.
- Slots and openings on the back or top of the cabinet are provided for ventilation. Do not block these slots. Never place this product near or over a radiator or heat source unless proper ventilation is provided.
- The monitor should be operated only from the type of power source indicated on the label. If you are not sure of the type of power supply to your home, consult your dealer or local power company.
- Use the appropriate power plug which complies with your local power standard.
- Do not overload power strips and extension cords. Overloading can result in fire or electric shock.
- Avoid dust, humidity, and temperature extremes. Do not place the monitor in any area where it may become wet. Place the monitor on a stable surface.
- Unplug the unit during a lightning storm or if it will not be used for a long period of time. This will protect the monitor from damage due to power surges.
- Never push objects or spill liquid of any kind into the slots on the monitor cabinet.
- To ensure satisfactory operation, use the monitor only with UL listed computers which have appropriate configured receptacles marked between 100 ~ 240V AC.
- The socket-outlet shall be installed near the equipment and shall be easily accessible
- If you encounter technical problems with the monitor, contact a qualified service technician or your retailer.
- Provide an earthing connection before the mains plug is connected to the mains. And, when disconnecting the earthing connection, be sure to disconnect after pulling out the mains plug from the mains.

WARNING

Usage of other than specified head- or earphones can result in hearing loss due to excessive sound pressures.

Care & Cleaning

- Before you lift or reposition your monitor, it is better to disconnect the cables and power cord. Follow the correct lifting techniques when positioning the monitor. When lifting or carrying the monitor, grasp the edges of the monitor. Do not lift the display by the stand or the cord.
- Cleaning. Turn your monitor off and unplug the power cord. Clean the monitor surface with a lint-free, non-abrasive cloth. Stubborn stains may be removed with a cloth dampened with mild cleaner.
- Avoid using a cleaner containing alcohol or acetone. Use a cleaner intended for use with the LCD. Never spray cleaner directly on the screen, as it may drip inside the monitor and cause an electric shock.

The following symptoms are normal with the monitor:

- The screen may flicker during the initial use due to the nature of the fluorescent light. Turn off the Power Switch and turn it on again to make sure that the flicker disappears.
- You may find slightly uneven brightness on the screen depending on the desktop pattern you use.
- When the same image is displayed for hours, an afterimage of the previous screen may remain after switching the image. The screen will recover slowly or you can turn off the Power Switch for hours.
- When the screen becomes black or flashes, or cannot work anymore, contact your dealer or service center to fix it. Do not repair the screen by yourself!

Conventions used in this guide



WARNING: Information to prevent injury to yourself when trying to complete a task.



CAUTION: Information to prevent damage to the components when trying to complete a task.



IMPORTANT: Information that you **MUST** follow to complete a task.



NOTE: Tips and additional information to aid in completing a task.

Where to find more information

Refer to the following sources for additional information and for product and software updates.

1. ASUS websites

The ASUS websites worldwide provide updated information on ASUS hardware and software products. Refer to **<http://www.asus.com>**

2. Optional documentation

Your product package may include optional documentation that may have been added by your dealer. These documents are not part of the standard package.

Takeback Services

ASUS recycling and takeback programs come from our commitment to the highest standards for protecting our environment. We believe in providing solutions for our customers to be able to responsibly recycle our products, batteries and other components as well as the packaging materials.

Please go to <http://csr.asus.com/english/Takeback.htm> for detail recycling information in different region.

1.1 Welcome!

Thank you for purchasing the ASUS® LCD monitor!

The latest widescreen LCD monitor from ASUS provides a crisper, broader, and brighter display, plus a host of features that enhance your viewing experience.

With these features, you can enjoy the convenience and delightful visual experience that the monitor brings you!

1.2 Package contents

Check your package for the following items:

- ✓ LCD Monitor
- ✓ Quick Start Guide
- ✓ Warranty Card
- ✓ USB Type-C Cable
- ✓ Micro HDMI to HDMI cable
- ✓ Color calibration testing report
- ✓ ProArt welcome card
- ✓ USB Type-C to A Adapter
- ✓ USB C to A Cable
- ✓ Smart Cover
- ✓ Power Adapter



-
- If any of the above items is damaged or missing, contact your retailer immediately.
-

1.3 Connect cables

A

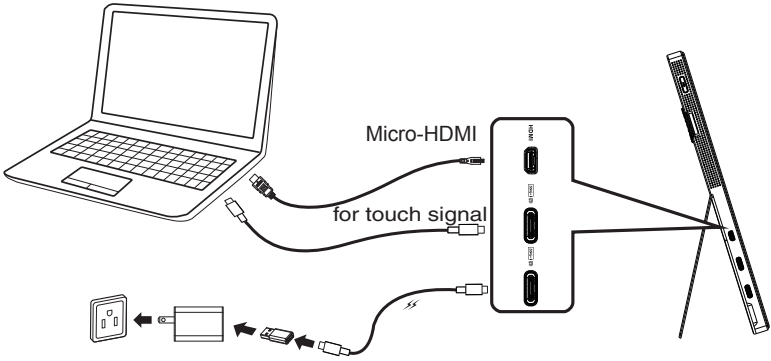

B

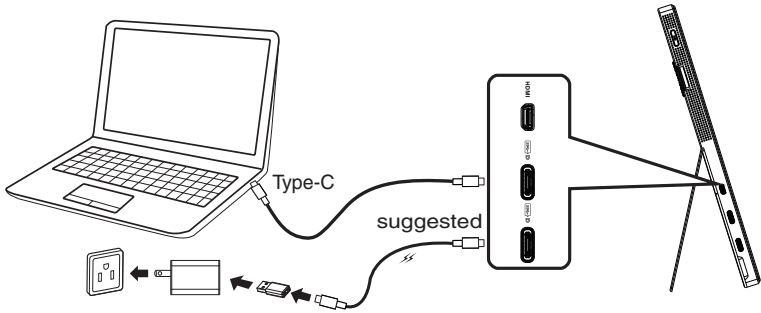

1.4 Monitor introduction

1.4.1 Using the Controls button

Use the control button on the left of the monitor to adjust the image settings.

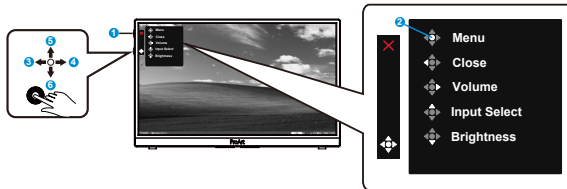

1. **Power button/power indicator:**
 - Turns the monitor on/off.
 - The color definition of the power indicator is as the below table.

Status	Description
White	ON
Amber	Standby mode
OFF	OFF

2. **Menu button:**
 - Enters the OSD menu.
3. **Close Button:**
 - Exit the OSD menu.
 - Press the button to active OSD when in connection to a valid source.
4. **Volume Button**
 - Adjust the volume level.
 - Press the button to active OSD when in connection to a valid source.
5. **Input Select Button:**
 - Use this hotkey to switch from HDMI, USB Type-C1 and USB Type-C2 input signal.
 - Press the button to active OSD when in connection to a valid source.
6. **Brightness Button:**
 - Adjust the Brightness value.
 - Press and hold it for 5 seconds to enable/disable Keys Lock.

2.1 Adjusting the monitor

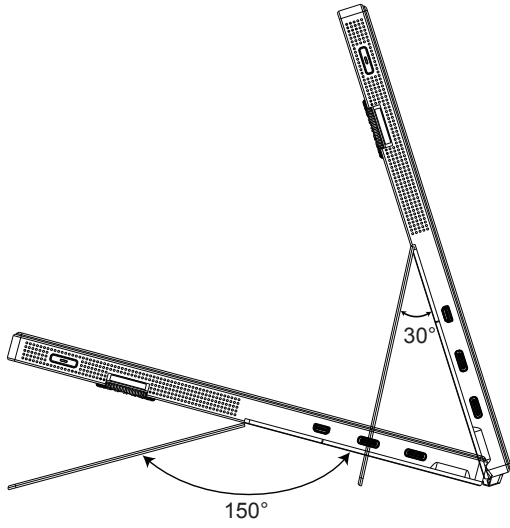

3.1 OSD (On-Screen Display) menu

3.1.1 How to reconfigure

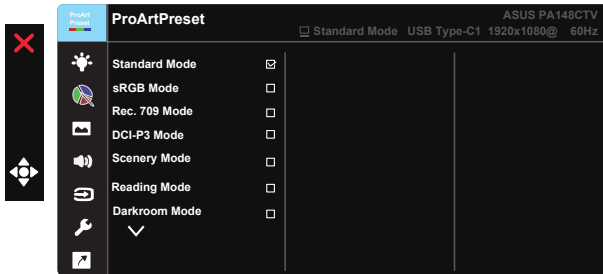

1. Press Central of 5-way to activate the OSD menu.
2. Press the ▼ and ▲ buttons to toggle between options in the Menu. As you move from one icon to another, the option name is highlighted.
3. To select the highlighted item on the menu press the Center key.
4. Press the ▼ and ▲ buttons to select the desired parameter.
5. Press the Center key to enter the slide bar and then use the ▼ or ▲ buttons, according to the indicators on the menu, to make your changes.
6. Press the ◀/▶ to move left / right menu.

3.1.2 OSD Function Introduction

1. ProArtPreset

This function contains nine sub-functions that you can select for your preference.

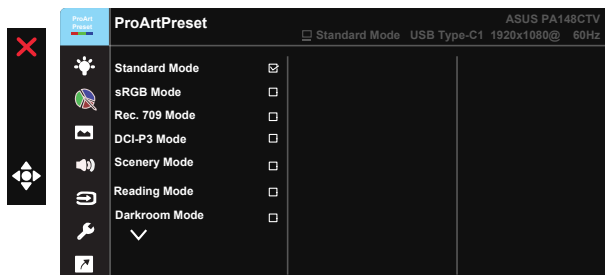

- **Standard Mode:** Best choice for document editing.
- **sRGB Mode:** Compatible with sRGB color space, sRGB mode is the best choice for document editing.
- **Rec. 709 Mode:** Compatible with Rec. 709 color space.
- **DCI-P3 Mode:** Compatible with DCI-P3 color space.
- **Scenery Mode:** Best choice for scenery photo display.
- **Reading Mode:** This is the best choice for book reading.
- **Darkroom Mode:** This is the best choice for a weak ambient light environment.
- **User Mode 1:** Allows you to make color adjustments in the Advanced Setting.
- **User Mode 2:** Allows you to make color adjustments in the Advanced Setting.



- ASCR is not user-configurable in standard, sRGB, Rec.709, DCI-P3 Mode.
- Gamma is not user-configurable in sRGB, DCI-P3 and scenery Mode.
- Color Temp., brightness, contrast, saturation, hue, ProArt Palette/Color and black level are not user-configurable in sRGB mode.



Color Engine	Standard Mode	sRGB Mode	Rec. 709 Mode	DCI-P3 Mode	Scenery Mode	Reading Mode	Darkroom Mode	User Mode 1	User Mode 2
Color Temp.	V	NA	V	V (*1)	V	NA	V	V	V
Brightness	V	NA	V	V	V	V	V	V	V
Contrast	V	V	V	V	V	V	V	V	V
ASCR	NA	NA	NA	NA	V	V	V	V	V
Sharpness	V	V	V	V	V	V	V	V	V
Saturation	V	NA	V	V	V	NA	V	V	V
Hue	V	NA	V	V	V	NA	V	V	V
ProArt Palette/Color	V	NA	V	V	V	V	V	NA	NA
Black Level	V	V	V	V	V	V	V	NA	NA
Gamma	V	NA	V	NA	NA	V	V	V	V

V: adjustable

NA: function disabled

(*1) 6500K & P3-Theater(default) only

(*2) 6500K(default) & 9300K only

2. Blue Light Filter

Adjust the energy level of blue light emitted from LED backlight.

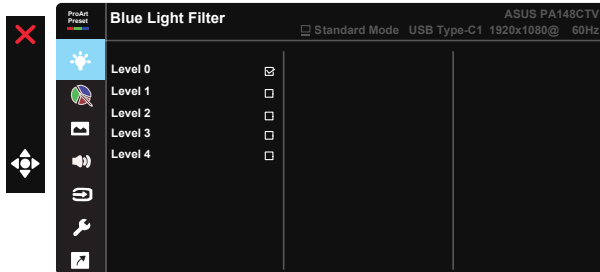

- **Level 0:** No change



- When Blue Light Filter is activated, the default settings of Standard Mode will be automatically imported.
- Between Level 1 to Level 3, the Brightness function is user-configurable.
- Level 4 is optimized setting. It is compliance with TUV Low Blue Light Certification. The Brightness function is not user-configurable.



Please refer to the following to alleviate eye strains:

- Users should take some time away from the display if working for long hours. It is advised to take short breaks (at least 5 mins) after around 1 hour of continuous working at the computer. Taking short and frequent breaks is more effective than a single longer break.
- To minimize eye strain and dryness in your eyes, users should rest the eye periodically by focusing on objects that are far away.
- Eye exercises can help to reduce eye strain. Repeat these exercises often. If eye strain continues please consult a physician. Eye exercises: (1) Repeating look up and down (2) Slowly roll your eyes (3) Move your eyes diagonal.
- High energy blue light may lead to eye strain and AMD (Age-Related Macular Degeneration). Blue light Filter to reduce 70% (max.) harmful blue light to avoiding CVS (Computer Vision Syndrome).

3. ProArtPalette

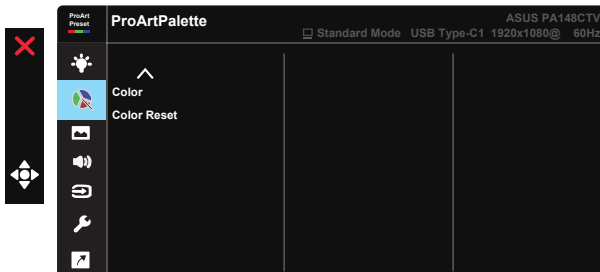
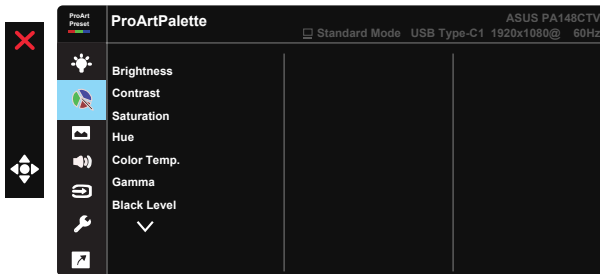

- **Brightness:** The adjusting range is from 0 to 100.
- **Contrast:** The adjusting range is from 0 to 100.

- **Saturation:** The adjusting range is from 0 to 100.
- **Hue:** Shifts the image color between green and purple
- **Color Temp.:** Contains five preset color modes 9300K, 6500K, 5500K, 5000K and P3-Theater.
- **Gamma:** Contains five gamma modes including 1.8, 2.0, 2.2, 2.4, 2.6.
- **Black Level:** To adjust the initialized 1st signal level of darkest gray level.
- **Color:**
 - * Six-axis Hue adjustment.
 - * Six-axis Saturation adjustment.
 - * Adjusts the gain levels for R, G, B.
 - * Adjusts the offset values for R, G, B.
- **Color Reset:**
 - * Current mode color reset:
Resets the color settings of current color mode to the factory default value.
 - * All modes color reset:
Resets the color settings of all color modes to the factory default value.



P3-Theater is only available when DCI-P3 Mode is selected.

4. Image

You can adjust Sharpness, Trace Free, Aspect Control, Input Range and ASCR from this main function.

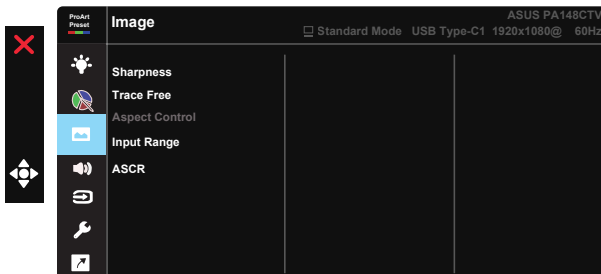

- **Sharpness:** Adjusts the picture sharpness. The adjusting range is from 0 to 100.
- **Trace Free:** Speeds up the response time by Over Drive technology. The adjusting range is from lower 0 to faster 100.
- **Aspect Control:** Adjusts the aspect ratio to Full, 4:3.



4:3 is only available when input source is in 4:3 format.

- **Input Range:** Adjust input range to Auto, Full and Limited 16-235.
- **ASCR:** Select ON or OFF to enable or disable dynamic contrast ratio function.

5. Sound

You can adjust Volume, and Mute from this main function.

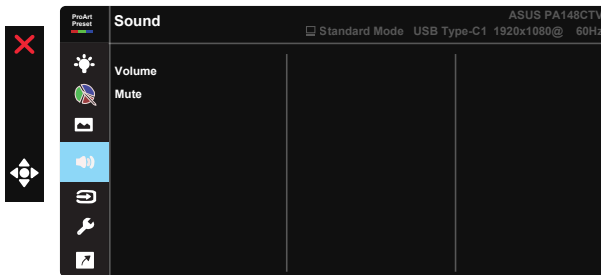

- **Volume :** Adjusts the output volume level.
- **Mute :** Select audio mute ON or OFF.

6. Input Select

Select the input source from HDMI, USB Type-C1, USB Type-C2.

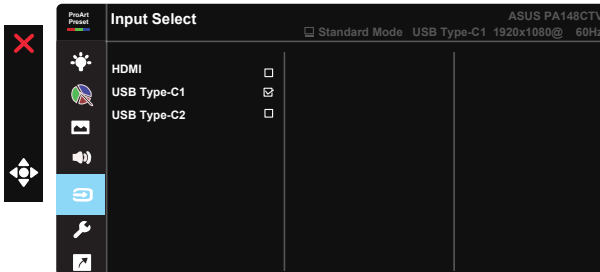

7. System Setup

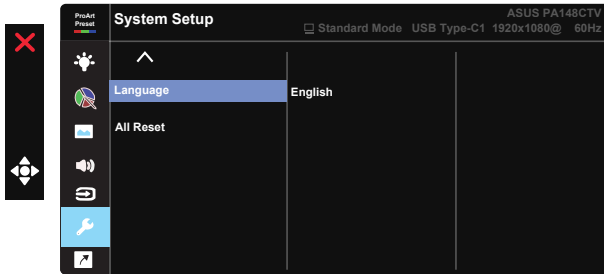
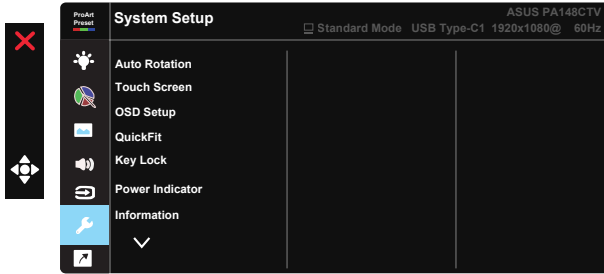

- **Auto Rotation:** To enable/disable rotate image automatically. Please be noted that Auto rotation function is only working under Windows OS by installing DisplayWidget software.
- **Touch Screen:** ProArt Display PA148CTV is a touch monitor which uses 10 point touch panel technology. Please use with latest OS like Windows 10. You can use either single finger touch, or multi-finger touch up to maximum simultaneous 10 touch points.

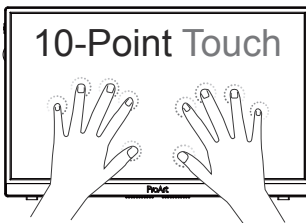

- **OSD Setup:** Adjusts the OSD Timeout, DDC/CI, and Transparency of the OSD screen.
- **QuickFit:** Allows users to have a preview of the document or photo layout directly on screen without printing test copies.
 - * **Ruler:** This pattern presents physical ruler on top and left side. You can press the ◀ Return button for longer than 3 seconds to switch the measurements between metric and imperial.



- * **Alignment:** Facilitates designers and users to organize content and layout on one page and achieve a consistent look and feel.

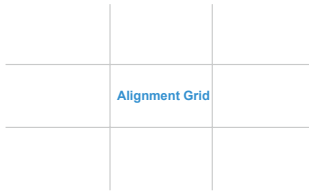

- * **Square:** Show a square in the center.

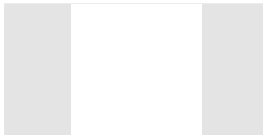

- **Key Lock:** Disable all key functions. Pressing the down button for more than five seconds to disable key lock function.
- **Power Indicator:** Turn the power LED indicator on/off.
- **Information:** Displays the monitor information.
- **language:** Select OSD language. The selections are: **English, French, German, Spanish, Italian, Dutch, , Russian, Poland, Czech, Croacia, Hungary, Romania, Portugal, Turkey, Simplified Chinese, Traditional Chinese, Japanese, Korean, Persian, Thai, Indonesian.**
- **All Reset:** Selects “Yes” to revert all settings to the factory default mode.

8. Shortcut

Selecting this option allows you to set three shortcut keys. User can select from Blue Light Filter, Brightness, Contrast, Input Select, Color Temp., Volume, sRGB Mode, Rec. 709 Mode, DCI-P3 Mode, User Mode 1, User Mode 2 and set as shortcut key.



3.2 Specifications

Model	PA148CTV
Panel Size	14''(16:9) Wide Screen
Resolution	1920 x 1080
Brightness (Typ.)	300 nites
Contrast (Typ.)	700:1
Display Colors	16.2M
Digital Input	DisplayPort™ Alt Mode for USB Type-C™ HDMI via Micro HDMI
Touch	Yes
Power Consumption	≤ 10 W
Operating Temp.	0°C ~ 40°C
Operating Humidity	20-90% RH
Speaker	1W x 2
Phys. Dimension (WxHxD)	326.1 x 13.08 x 204.4 mm
Box Dimension (WxHxD)	413 x 342 x 90 mm
Net Weight (Esti.)	0.74 kg
Gross Weight (Esti.)	2.5 kg
Regulation Approvals	UL/cUL, CB, CE, CCC, KCC, FCC, BSMI, EAC(CU), RCM, VCCI, J-Moss, UkrSEPRO, RoHS, WEEE, Windows 7 & 8.1 & 10 WHQL, Blue light filter, Flicker free, BIS, e-Standby, Energy Star 8.0, Vietnam MEPS
Voltage Rating	5 - 9V \equiv , 2.0A QC3.0 charging spec is supported
Adapter	ASUS/AD2068M20 100-240V~50/60Hz 0.5A 5V \equiv ,2A(Normal model) OR 9V \equiv , 2A(Quick charge model)

3.3 Troubleshooting (FAQ)

Problem	Possible Solution
Power LED is not ON	<ul style="list-style-type: none">• Press the  button to check if the monitor is in the ON mode.• Check if the power cord is properly connected to the monitor and the power outlet.• Check Power Indicator function in main menu OSD. Select "ON" to turn on power LED.
The power LED lights amber and there is no screen image	<ul style="list-style-type: none">• Check if the monitor and the computer are in the ON mode.• Make sure the signal cable is properly connected the monitor and the computer.• Inspect the signal cable and make sure none of the pins are bent.• Connect the computer with another available monitor to check if the computer is properly working.• Make sure Input Select setting is a valid signal.
Screen image is too light or dark	<ul style="list-style-type: none">• Adjust the Contrast and Brightness settings via OSD.
Screen image bounces or a wave pattern is present in the image	<ul style="list-style-type: none">• Make sure the signal cable is properly connected to the monitor and the computer.• Move electrical devices that may cause electrical interference.
Screen image has color defects (white does not look white)	<ul style="list-style-type: none">• Inspect the signal cable and make sure that none of the pins are bent.• Perform Reset via OSD.• Adjust the R/G/B color settings or select the Color Temperature via OSD.
No sound or sound is low	<ul style="list-style-type: none">• Adjust the volume settings of both your monitor and computer.• Make sure the computer sound card driver is properly installed and activated.

3.4 Supported Timing List

PC Supported Primary Timing

Resolution	Refresh Rate	Horizontal Frequency
640x480	60Hz	31.469kHz
800x600	60Hz	37.879kHz
1024x768	60Hz	48.363kHz
1280x960	60Hz	60kHz
1280x1024	60Hz	63.981kHz
1440x900	60Hz	55.935kHz
1680x1050	60Hz	65.29kHz
1920x1080	60Hz	67.5kHz

VESA Modes, User Available Timing

Resolution	Refresh Rate	Horizontal Frequency
848x480	60Hz	31.02kHz
1280x720	60Hz	44.772kHz
1280x800	60Hz	49.702kHz
1920x1080	60Hz	66.587kHz

* The modes not listed in the above tables may not be supported. For optimal resolution, we recommend that you choose a mode listed in the above tables.