



User's Manual

FlexScan® S2134

Color LCD Monitor

Important

Please read this "User's Manual", and "PRECAUTIONS" (separate volume) carefully to familiarize yourself with safe and effective usage.

- See the Setup Guide for monitor installation and connection.
- For the latest product information including the "User's Manual", refer to our web site:
www.eizoglobal.com

Location of Caution Statement

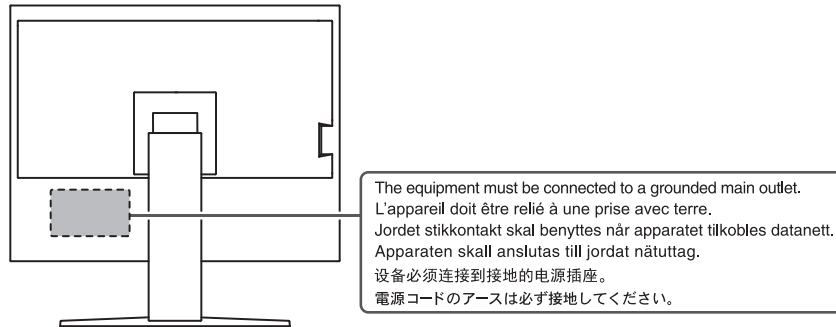

This product has been adjusted specifically for use in the region to which it was originally shipped.

If operated outside this region, the product may not perform as stated in the specifications.

No part of this manual may be reproduced, stored in a retrieval system, or transmitted, in any form or by any means, electronic, mechanical, or otherwise, without the prior written permission of EIZO Corporation.

EIZO Corporation is under no obligation to hold any submitted material or information confidential unless prior arrangements are made pursuant to EIZO Corporation's receipt of said information. Although every effort has been made to ensure that this manual provides up-to-date information, please note that EIZO product specifications are subject to change without notice.

About This Product

About the Usage of This Product

- This product is suited to general purposes like creating documents, viewing multimedia content (assuming usage of approximate 12 hours per day).
- If using this product for the following kinds of applications, where an extremely high degree of reliability and safety is required, then measures should be in place to maintain safety while using this product:
 - Transportation equipment (ships, aircraft, trains, and automobiles)
 - Safety devices (Disaster prevention systems, security control systems, etc.)
 - Life-critical devices (medical devices, such as life-support devices and operating room devices)
 - Nuclear energy control devices (Nuclear energy control systems, security control systems of nuclear facilities, etc.)
 - Major system communication devices (operation control systems of transportation systems, air traffic control systems, etc.)
- This product has been adjusted specifically for use in the region to which it was originally shipped. If the product is used outside the region, it may not operate as specified in the specifications.
- This product may not be covered by warranty for uses other than those described in this manual.
- The specifications noted in this manual are only applicable when the following are used:
 - Power cords provided with the product
 - Signal cables specified by us
- Only use optional products manufactured or specified by us with this product.

About the LCD Panel

- It takes about 30 minutes (under our measurement conditions) for the monitor display to stabilize. Please wait 30 minutes or more after the monitor power has been turned on, and then adjust the monitor.
- Monitors should be set to a lower brightness to prevent a loss in the screen quality caused by long-term use and to maintain stable use.
- When the screen image is changed after displaying the same image for extended periods of time, an afterimage may remain. Use the screensaver or power save function to avoid displaying the same image for extended periods of time. An afterimage may appear even after a short time period has elapsed depending on the displayed image. To remove such a phenomenon, change the image or keep the power turned off for several hours.
- If the monitor displays continuously over a long period of time, smudges or burn-in may appear. To maximize the life of the monitor, we recommend the monitor be turned off periodically.
- The LCD panel is manufactured using high-precision technology. Although, missing pixels or lit pixels may appear on the LCD panel, this is not a malfunction. Percentage of effective dots: 99.9994 % or higher.
- The backlight of the LCD panel has a fixed lifetime. Depending on the usage pattern, such as usage for long continuous periods, the lifespan of the backlight may run out sooner, requiring replacement. When the screen becomes dark or begins to flicker, please contact your local EIZO representative.

- Do not press hard on the surface or outer frame of the LCD panel, as this may result in display malfunctions, such as interference patterns, etc. If pressure is continuously applied to the LCD panel surface, the liquid crystal may deteriorate or the LCD panel may be damaged. (If the pressure marks remain on the LCD panel, leave the monitor with a black or white screen. The symptom may disappear.)
- Do not scratch or press on the LCD panel with any sharp objects, at this may result in damage to the LCD panel. Do not attempt to brush with tissues as this may scratch the panel.

About the Installation

- If you place this product on a lacquer-coated desk, the color may adhere to the bottom of the stand due to the composition of the rubber. Check the desk surface before use.
- Dew condensation may form on the surface or interior of this product when it is brought into a cold room, when the temperature suddenly rises, or when it is moved from a cold room to a warm room. In that case, do not turn the product on. Instead wait until the dew condensation disappears, otherwise it may cause some damage to the product.

Cleaning

- Periodic cleaning is recommended to keep the product looking new and to prolong its operation lifetime.
- Stains on the product can be removed by moistening part of a soft cloth with water or by using our ScreenCleaner and gently wiping.

Attention
<ul style="list-style-type: none">• Do not let liquids come into direct contact with the product. If it does, wipe it off immediately.• Do not allow liquids to get into gaps or inside the product.• When using chemicals for cleaning or disinfection, chemicals such as alcohol and disinfectant may cause gloss variation, tarnishing, and fading of the product, and also quality deterioration of the displayed image. Do not use chemicals on a frequent basis.• Never use a thinner, benzene, wax, or abrasive cleaner as they may damage the product.• For more information on cleaning and disinfection, please refer to our web site. How to check: Access www.eizoglobal.com and type "disinfect" in the site search box to search.

To Use the Monitor Comfortably

- An excessively dark or bright screen may affect your eyes. Adjust the brightness of the monitor according to the environmental conditions.
- Staring at the monitor for a long time tires your eyes. Take a 10-minute rest every hour.
- Look at the screen from a proper distance and from a proper angle.

CONTENTS

Location of Caution Statement	2
About This Product	3
About the Usage of This Product	3
About the LCD Panel	3
About the Installation.....	4
Cleaning	4
To Use the Monitor Comfortably	4
1 Introduction	7
1.1 Features	7
1.1.1 Reduction of Power Consumption	7
1.1.2 Supports 3 input signals.....	7
1.1.3 Equipped with an IPS panel.....	7
1.2 Controls and Functions	8
1.2.1 Front.....	8
1.2.2 Rear	9
1.3 Supported Resolutions	10
2 Basic Adjustment/Setting.....	11
2.1 Switch Operation Method.....	11
2.2 Switching Input Signals	11
2.3 Switching Display Modes (Color Modes)	11
2.3.1 Color Modes.....	12
2.4 Conserving Energy.....	12
2.5 Adjusting Brightness	13
3 Advanced Adjustments/Settings	15
3.1 Basic Operation of the Setting Menu	15
3.2 Setting Menu Functions	16
3.2.1 Color	16
3.2.2 Signal	18
3.2.3 Preferences.....	21
3.2.4 Languages	22
3.2.5 Information.....	22
4 Administrator Settings.....	24
4.1 Basic Operation of the "Administrator Settings" Menu.....	24
4.2 Functions of the "Administrator Settings" Menu.....	25
5 Troubleshooting	27
5.1 No Picture	27
5.2 Imaging Problems (or Both Digital and Analog).....	28

CONTENTS

5.3	Imaging Problems (Analog only)	29
5.4	Other Problems	29
6	Reference	31
6.1	Attaching an Optional Monitor Arm	31
6.2	Connecting Multiple PCs	33
6.3	Using the USB Hub Function	33
6.4	Specifications	35
6.4.1	LCD Panel.....	35
6.4.2	Video Signals	35
6.4.3	USB.....	35
6.4.4	Power	35
6.4.5	Physical Specifications	35
6.4.6	Operating Environmental Requirements.....	36
6.4.7	Transportation / Storage Environmental Requirements.....	36
6.4.8	Accessories.....	36
	Appendix	37
	Trademark.....	37
	License.....	37

1 Introduction

Thank you very much for choosing an EIZO color LCD monitor.

1.1 Features

1.1.1 Reduction of Power Consumption

This product provides a function that automatically adjusts the screen brightness to reduce power consumption ^{*1}. Power Reduction, CO₂ Reduction, and Eco Performance Level can be checked on the "EcoView Settings" menu (see [2.4 Conserving Energy \[▶ 12\]](#)).

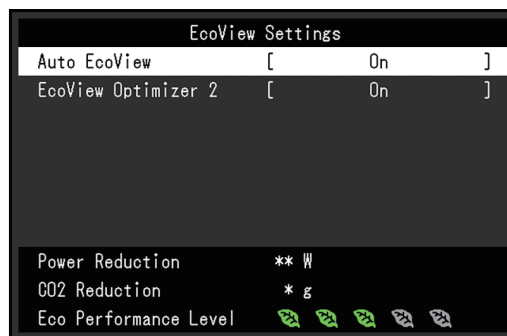

- Auto EcoView
The ambient light sensor on the front of the monitor detects the ambient brightness to automatically adjust the screen brightness to a comfortable level.
- EcoView Optimizer 2
The monitor automatically adjusts the screen brightness according to the white level of the input signal. This function can reduce power consumption while maintaining the brightness specified by the input signal.

^{*1} Reference values
Maximum power consumption: 42 W (when a USB device is connected), standard power consumption: 13 W (brightness 120 cd/m², when no USB device is connected, at default settings)

1.1.2 Supports 3 input signals

Equipped with three inputs (DisplayPort™, DVI-D, D-Sub mini 15-pin) that allow connection to various computers and external devices.

1.1.3 Equipped with an IPS panel

Equipped with an IPS panel that minimizes changes in hue and contrast even when the screen is viewed from an angle.

1.2 Controls and Functions

1.2.1 Front

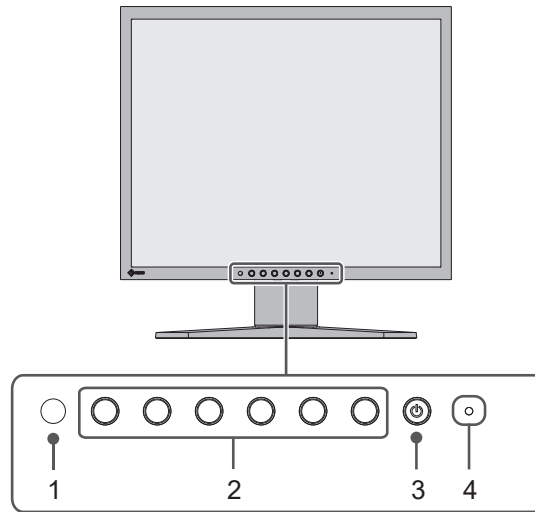

1. Ambient light sensor	Detects ambient brightness. If you use Auto EcoView, the screen brightness is automatically adjusted according to the ambient brightness (see Auto EcoView [▶ 13]).
2. Operation switches	Displays menus (see 2.1 Switch Operation Method [▶ 11]). Operate the switches according to the operation guide (see 3.1 Basic Operation of the Setting Menu [▶ 15]).
3. Power switch	Turns the power on or off.
4. Power indicator	Indicates the monitor's operation status. White: Normal operation mode Orange: Power saving mode OFF: Power off

1.2.2 Rear

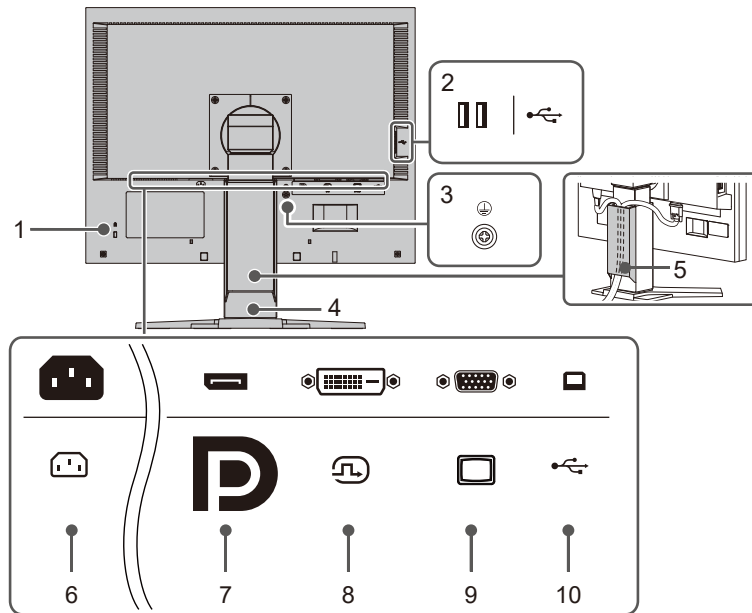

1. Security lock slot	Complies with Kensington's MicroSaver security system.
2. USB-A connector (downstream)	Connects to a peripheral USB device (see 6.3 Using the USB Hub Function [▶ 33]).
3. Protective earth terminal	This terminal is used to connect the earth wire. Use an earth wire with minimum conductor size of 0.75 mm, and with a terminal of suitable material.
4. Stand^{*1}	Adjusts the height and angle (tilt and swivel) of the monitor. The monitor can also be rotated vertically.
5. Cable holder	Holds the monitor cables.
6. Power connector	Connects the power cord.
7. DisplayPort connector	Connects to a PC with DisplayPort output.
8. DVI-D connector	Connects to a PC with DVI-D output.
9. D-Sub15 pin (mini) connector	Connects to a PC with D-Sub output.
10. USB-B connector (upstream)	Connect a USB cable when using the USB hub function (see 6.3 Using the USB Hub Function [▶ 33]).

^{*1} An optional arm (or optional stand) can be attached by removing the stand section.

1.3 Supported Resolutions

The monitor supports the following resolutions:

✓: Supported, -: Not supported

Resolution	Vertical scan frequency (Hz)	DisplayPort	DVI-D	D-Sub
640 x 480	59.940	✓	✓	✓
640 x 480	72.809	-	-	✓
640 x 480	75.000	-	-	✓
720 x 400	70.087	✓	✓	✓
800 x 600	56.250	-	-	✓
800 x 600	60.317	✓	✓	✓
800 x 600	72.188	-	-	✓
800 x 600	75.000	-	-	✓
1024 x 768	60.004	✓	✓	✓
1024 x 768	70.069	-	-	✓
1024 x 768	75.029	-	-	✓
1152 x 864	75.000	-	-	✓
1280 x 960	60.000	✓	✓	✓
1280 x 1024	60.020	✓	✓	✓
1280 x 1024	75.025	-	-	✓
1600 x 1200 ^{*1}	60.000	✓	✓	✓

*1 Recommended resolution

Note
<ul style="list-style-type: none"> • Only progressive is supported for the scan format.

2 Basic Adjustment/Setting

This product enables users to change the brightness according to personal preference or to suit the usage environment, and to reduce power consumption to conserve energy.





This chapter describes the basic functions that can be adjusted and set by pressing the switches on the front of the monitor.

For advanced adjustment and setting procedures using the Setting menu, see [3 Advanced Adjustments/Settings \[▶ 15\]](#).

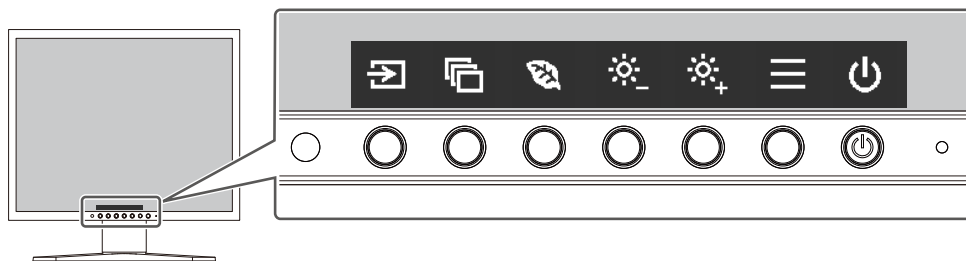
2.1 Switch Operation Method

1. Press any switch (except )
The operation guide appears on the screen.



2. Press a switch for adjustment/setting.
The Adjustment/Setting menu appears.
(A sub menu may also be displayed. In this case, select the item for adjustment/setting using   and select .)
3. Perform adjustment/setting with the switches and select  to accept the changes.
4. Select  to exit the menu.

2.2 Switching Input Signals

When a monitor has multiple signal inputs, the signal to display on-screen can be changed.

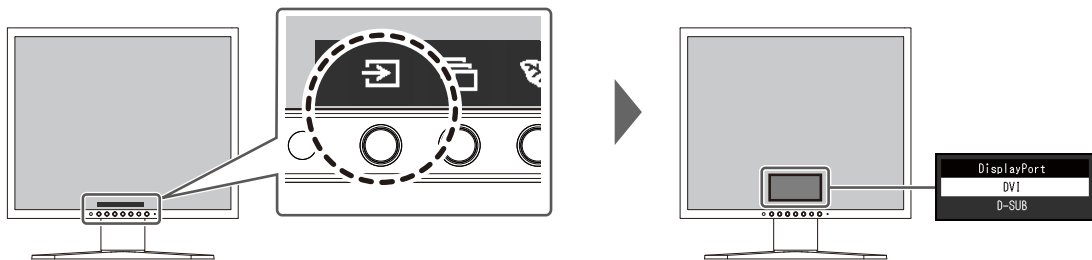

2.3 Switching Display Modes (Color Modes)

This product is preinstalled with color modes for various display purposes.

By switching the color mode according to the purpose and contents of the display, you can display images in an appropriate manner.

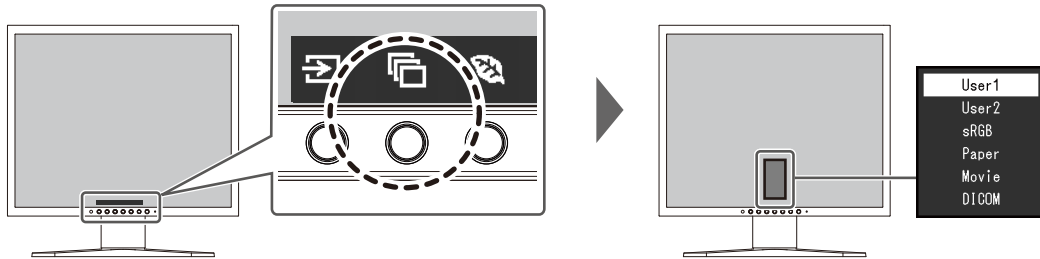

2.3.1 Color Modes

Color mode	Purpose
User 1 / User 2	Select either of these modes to set a user-defined display mode.
sRGB	This mode is suitable for matching color reproduction with peripheral devices that support sRGB, such as when printing photos taken using a digital camera.
Paper	This mode uses color tones and contrast similar to that of paper to produce a printed paper effect. It is suitable for displaying images from media such as books and documents.
Movie	This mode displays moving images brightly and with a clear-cut three-dimensional appearance. It is suitable for playing back video content.
DICOM	Select this mode to simply display digital imaging for medical based on DICOM® Part 14. "EcoView Settings" and "Color" become invalid, and cannot be adjusted or set. Note <ul style="list-style-type: none"> This is not intended to be used for diagnostic purposes.

Note
<ul style="list-style-type: none"> In Paper mode, the amount of blue light emitted from the screen is reduced by changing the color tone and controlling the brightness.

2.4 Conserving Energy

This monitor is equipped with EcoView functions to enable users to conserve energy.

If you use Auto EcoView, which is one of the EcoView functions, the screen brightness is automatically adjusted according to the ambient brightness.

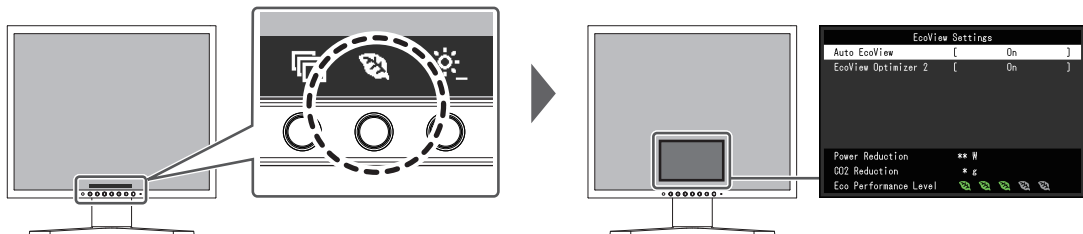

Note

- The power saving level (Power Reduction, CO₂ Reduction, and Eco Performance Level) can be checked on the "EcoView Settings" menu. The more indicators that light up representing the Eco Performance Level, the higher the power saving level attained.
 - Power Reduction: the reduction in the backlight's power consumption as a result of the adjusted brightness value.
 - CO₂ Reduction: converted from the "Power Reduction" value, this is an estimate of the quantity of CO₂ emissions reduced when using the monitor for one hour.
- The figures are calculated based on the Emission factors by electric power company (FY2022 results) - TEPCO Energy Partner "Menu J (residual)" published by the Ministry of the Environment of Japan.

Auto EcoView

Settings: "On" / "Off"

The ambient light sensor on the front of the monitor detects the ambient brightness to automatically adjust the screen brightness to a comfortable level using Auto EcoView.

The power consumption of the backlight can be curtailed by adjusting the brightness to an appropriate level.

This function can also mitigate eye strain and tiredness caused by a screen that is too bright or too dark.

Note

- Be careful not to block the ambient light sensor on the lower side of the monitor when using Auto EcoView.
- Even when Auto EcoView is set to "On", you can change the brightness of the monitor using the operation switches () on the front of the monitor or in the color adjustment settings. The manner in which Auto EcoView changes the brightness will also vary depending on the value you set.
- When "DICOM" is selected for the color mode, the Auto EcoView setting is turned "Off".

EcoView Optimizer 2

Settings: "On" / "Off"

The monitor automatically adjusts the screen brightness according to the white level of the input signal.

This function can reduce power consumption while maintaining the brightness specified by the input signal.

Note

- The EcoView Optimizer 2 setting becomes "Off" in the following cases:
 - When "Movie" or "DICOM" is selected for the color mode
- When set to "On", the appearance of pale colors may change. If this bothers you, set this function to "Off".

2.5 Adjusting Brightness

Settings: "0" to "100"

The brightness of the screen can be adjusted to suit the installation environment or personal preference.

The screen brightness is adjusted by changing the brightness of the backlight (light source from the LCD back panel).

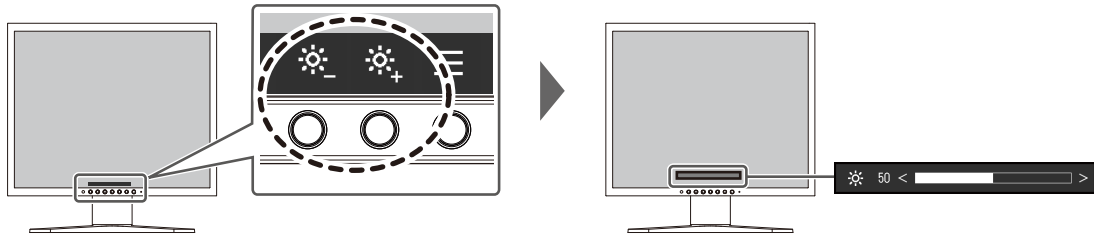



3 Advanced Adjustments/Settings



This chapter describes the advanced monitor adjustment and setting procedures using the Setting menu.

For basic functions, see [2 Basic Adjustment/Setting \[▶ 11\]](#).

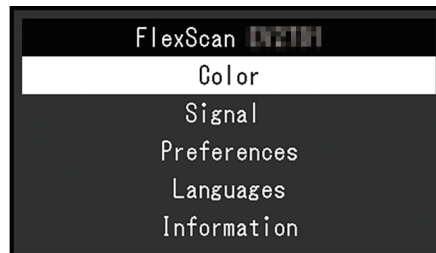

3.1 Basic Operation of the Setting Menu

1. Press any switch (except ).
The operation guide appears.
2. Select .
The Setting menu appears.



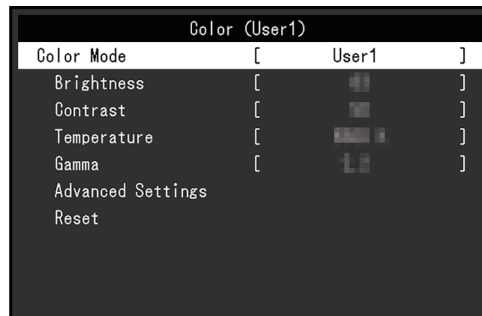





3. Select a menu to adjust/set with   and select .
The Sub menu appears.



4. Select a menu to adjust/set with   and select .
The Adjustment/Setting menu appears.



5. Perform adjustment/setting with   or   and select  to accept the changes.
The Sub menu appears.
Selecting  during adjustment/setting will cancel the adjustment/setting and restore the state prior to making changes.
6. Selecting  several times will terminate the Setting menu.

3.2 Setting Menu Functions

3.2.1 Color

The color mode settings can be adjusted according to personal preference. The adjusted settings are saved for each color mode.



Functions that can be adjusted differ depending on the color mode.

✓: Adjustable, -: Not adjustable

Function		Color Mode				
		User1 User2	sRGB	Paper	Movie	DICOM
Brightness		✓	✓	✓	✓	-
Contrast		✓	-	-	✓	-
Temperature		✓	-	✓	✓	-
Gamma		✓	-	-	-	-
Advanced Settings	Overdrive	✓	-	-	-	-
	Hue	✓	-	-	✓	-
	Saturation	✓	-	-	✓	-
	Gain	✓	-	-	-	-
Reset		✓	✓	✓	✓	-

Attention

- It takes about 30 minutes for the monitor display to stabilize. Please wait 30 minutes or more after power to the monitor has been turned on before adjusting the monitor.
- The same image may be observed in different colors on multiple monitors due to monitor-specific characteristics. Make fine color adjustments visually when matching colors across multiple monitors. Follow the procedure below to adjust and match colors across multiple monitors.
 1. Display a white screen on each monitor.
 2. Use one of the monitors as a visual reference point to make adjustments to "Brightness", "Temperature", and "Gain" on the other monitors.
- When Auto EcoView is set to "On", the same brightness setting is shared by all of the color modes and cannot be set individually for each color mode.

Color Mode

Settings: "User1" / "User2" / "sRGB" / "Paper" / "Movie" / "DICOM"

Select the desired mode according to the monitor application.

The color mode settings can also be adjusted according to personal preference. Select the color mode for adjustment and perform adjustment using the relevant functions.

Note

- For details on the adjustment status of each color mode, see [2.3 Switching Display Modes \(Color Modes\)](#) [▶ 11].

Brightness

Settings: "0" – "100"

The screen brightness is adjusted by changing the brightness of the backlight (light source from the LCD back panel).

Note

- If the image is too dark even when the brightness is set to 100, adjust the contrast.

Contrast

Settings: "0" – "100"

The brightness of the screen is adjusted by varying the video signal level.

Note

- A contrast of 50 displays every color gradation.
- When adjusting the monitor, it is recommended to perform brightness adjustment, which does not lose gradation characteristics, prior to contrast adjustment.
- Perform contrast adjustment in the following cases:
 - If the image is too dark even when the brightness is set to 100 (Set the contrast to higher than 50.)

Temperature

Settings: "Off" / "4000 K" – "10000 K" (in increments of 500 K. 9300 K is included.)

Adjusts the color temperature.

The color temperature is normally used to express the hue of "White" and/or "Black" with a numerical value. The value is expressed in degrees "K" (Kelvin).

The screen becomes reddish at low color temperatures and bluish at high color temperatures, similar to the temperatures of a flame. A gain preset value is set for each color temperature setting value.

Note

- The value shown in "K" is available only as a reference.
- "Gain" allows you to perform more advanced adjustment.
- If set to "Off", the image is displayed in the preset color of the LCD panel (Gain: 100 for each RGB channel).
- When the gain is changed, the color temperature setting changes to "Off".

Gamma

Settings: "1.8" / "2.0" / "2.2" / "2.4"

Adjusts the gamma.

While the brightness of the monitor varies depending on the video level of the input signal, the variation rate is not directly proportional to the input signal. Maintaining the balance between the input signal and brightness of the monitor is referred to as "Gamma correction".

Note

- If "sRGB" is selected for the color mode, "sRGB" is displayed for the gamma value.
- If "Paper" is selected for the color mode, "Paper" is displayed for the gamma value.
- If "DICOM" is selected for the color mode, "DICOM" is displayed for the gamma value.

Advanced Settings - Overdrive

Settings: "Enhanced" / "Standard" / "Off"

This function allows you to set the overdrive intensity based on the use of the monitor.

Image lag can be reduced by using the "Enhanced" setting when displaying moving images.

Note

- Depending on the display resolution and the setting of "[Picture Expansion \[▶ 19\]](#)", overdrive may be set to "Off".

Advanced Settings - Hue

Settings: "-50" – "50"

Adjusts the hue.

Note

- Using this function may prevent some color gradations from being able to be displayed.

Advanced Settings - Saturation

Settings: "-50" – "50"

Adjusts the color saturation.

Note

- Using this function may prevent some color gradations from being able to be displayed.
- The minimum value (-50) changes the screen to monochrome.

Advanced Settings - Gain

Settings: "0" – "100"

The brightness of each red, green, and blue color component is referred to as "Gain". The hue of "white" can be changed by adjusting the gain.

Note

- Using this function may prevent some color gradations from being able to be displayed.
- The gain value changes according to the color temperature.
- When the gain is changed, the color temperature setting changes to "Off".

Reset

Resets any color adjustments for the currently selected color mode back to the default settings.

3.2.2 Signal

Sets the details regarding the input signal, such as the screen size.

- For D-Sub input

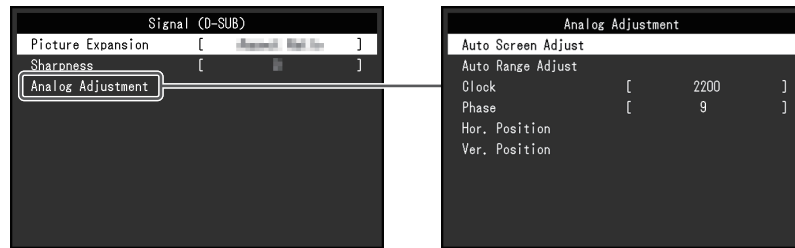

- For DisplayPort / DVI input



Functions that can be adjusted differ depending on the input signal.

✓: Adjustable, -: Not adjustable

Function	Input Signal		
	DisplayPort	DVI	D-Sub
Picture Expansion	✓	✓	✓
Sharpness	✓	✓	✓
Analog Adjustment	-	-	✓

Picture Expansion

Settings: "Full Screen" / "Aspect Ratio" / "Dot by Dot"

The screen size of the monitor display can be changed.

- "Full Screen"

Displays images in full screen. Since aspect ratios are not maintained, images may be distorted in some cases.
- "Aspect Ratio"

Images are enlarged to full screen without changing the aspect ratio. Since aspect ratios are maintained, blank horizontal or vertical borders may appear.
- "Dot by Dot"

Displays images at the set resolution or size specified by the input signal.

Note

- Setting example

Full-screen

Fixed aspect ratio

Actual size (input signal)

Sharpness

Settings: "-2" – "2"

When a low-resolution image is displayed using picture expansion mode ("Full Screen" or "Aspect Ratio"), the text and lines of the image may appear blurry. This blurriness can be reduced by configuring the settings for sharpness.

Note

- For some display resolutions, it is not necessary to configure the settings for sharpness. ("Sharpness" is not a value that can be selected.)

Analog Adjustment - Auto Screen Adjust

Screen flickering, display position, and size can be adjusted automatically. Selecting "Auto Screen Adjust" displays a message. Select "Yes" to enable this function.

Note

- The automatic screen adjustment function works correctly when an image is fully displayed over the entire displayable area of the screen. It does not work properly in the following cases:
 - When an image is only displayed on part of the screen (computer startup screen, etc.)
 - When a black background (wallpaper, etc.) is used
 Also, this function may not work properly with some graphic boards.
- When a signal is input into the monitor for the first time or when a resolution or vertical/horizontal scan frequency that has not been used before is set, the monitor will adjust automatically (only for signals with a resolution of 800 x 600 (SVGA) or higher).

Analog Adjustment - Auto Range Adjust

The signal output level can be automatically adjusted to enable display of all color gradations (0 to 255). When you select "Auto Range Adjust", a message will appear. Select "Yes".

Analog Adjustment - Clock

Flickering of vertical lines or part of the screen can be minimized.

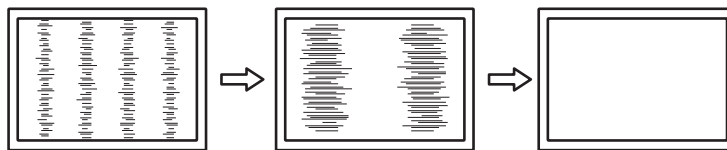

Note

- It is easy to overlook the point where the setting is suitable, so please finely adjust.

Analog Adjustment - Phase

Flickering or bleeding of the screen as a whole can be minimized.

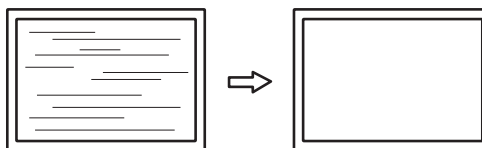

Note

- Flickering or bleeding may not fully disappear, depending on the PC and graphics board you are using.
- If vertical stripes appear on the screen after completing the setting, adjust "Clock" again.

Analog Adjustment - Hor. Position / Ver. Position

The display position (horizontal, vertical) of the screen can be adjusted.

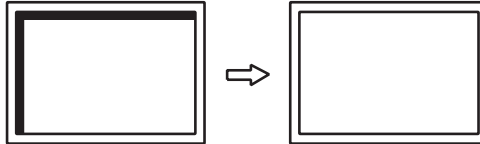
**Note**

- The number of pixels and the pixel positions of the LCD monitor are fixed, so there is one correct display position for images. Position adjustment is for adjusting an image to the correct position.

3.2.3 Preferences

The monitor's settings can be configured to suit the usage environment or personal preference.

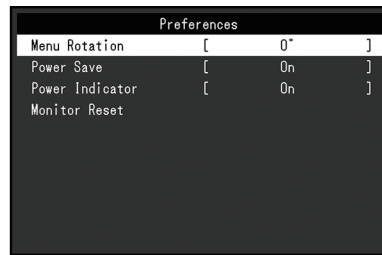
**Menu Rotation**

Settings: "0°" / "90°"

When the monitor is used in a portrait position, the direction of the Setting menu can also be changed.

Note

- Check whether the cables are connected properly.
- It is necessary to configure the settings of the PC to use the monitor in a portrait position. For details, refer to our web site (www.eizoglobal.com).

Power Save

Settings: "On" / "Off"

The monitor can be set to enter power saving mode according to the state of the PC.

The monitor changes to power saving mode about 15 seconds after signal input ceases to be detected.

When the monitor has shifted to power saving mode, images are not displayed on the screen.

- Exiting power saving mode
 - Press one of the operation switches (excluding ) on the front of the monitor
 - The monitor automatically exits power saving mode when the monitor receives input

Note

- At the time of shifting to power saving mode, a message that indicates the transition is displayed five seconds in advance.
- When not using the monitor, you can disconnect the power plug so that the power is cut completely.

Power Indicator

Settings: "On" / "Off"

The power indicator (white) can be turned off in normal operation mode.

Monitor Reset

Restores all settings to their default settings except for the following settings:

- Settings on the "Administrator Settings" menu

3.2.4 Languages

Settings: "English" / "German" / "French" / "Spanish" / "Italian" / "Swedish" / "Japanese" / "Simplified Chinese" / "Traditional Chinese"

The display language for menus and messages can be selected.



Attention

- The display language of the "Administrator Settings" menu (English) cannot be changed.

3.2.5 Information

You can check the monitor information (model name, serial number (S/N), firmware version, usage time) and the input signal information.

Example:

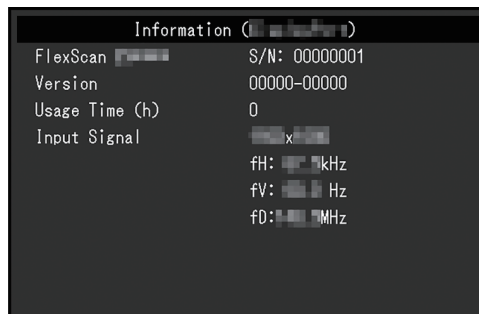

When  is selected, the certification standard logo appears on the screen.



4 Administrator Settings

This chapter describes how to configure monitor operation using the "Administrator Settings" menu.

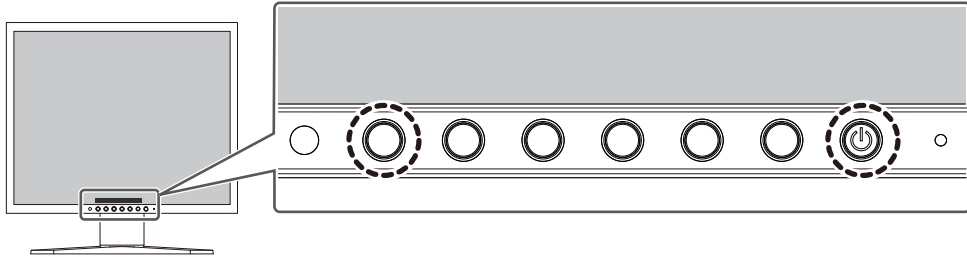

4.1 Basic Operation of the "Administrator Settings" Menu

1. Press  to turn off the monitor.
2. While pressing the leftmost switch, press  for more than 2 seconds to turn on the monitor.



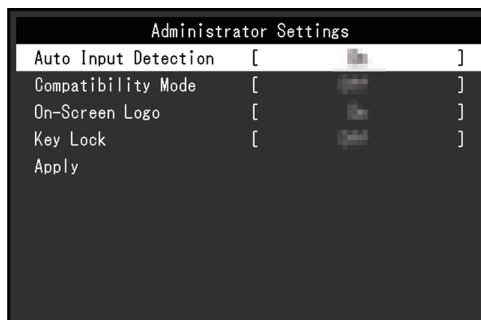



The "Administrator Settings" menu appears.

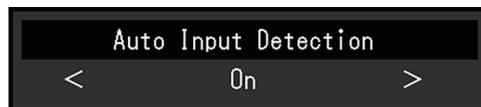

3. Select an item to set with   and select .
- The Adjustment/Setting menu appears.



4. Set with   and select .
 5. Select "Apply" and then .
- The settings are applied and the "Administrator Settings" menu exits.

Attention

- The language (English) of the "Administrator Settings" menu cannot be changed.

4.2 Functions of the "Administrator Settings" Menu

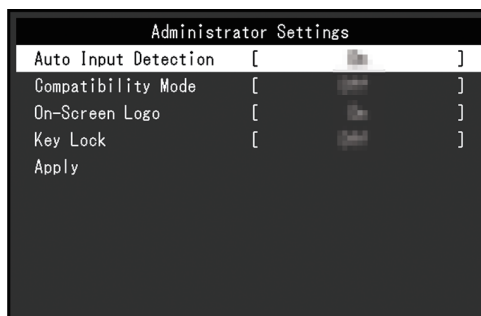

Auto Input Detection

Settings: "On" / "Off"

This function automatically recognizes the connector through which PC signals are input, and displays images on the screen accordingly.

- "On"

When the monitor is connected to multiple PCs, if a specific PC enters power saving mode or no signals are input to the monitor, the connector is automatically changed to another one to which signals are input.
- "Off"

To be set to this when manually selecting input signals. Select the input signal to display using the operation switch () on the front of the monitor. For details, see [2.2 Switching Input Signals \[▶ 11\]](#).

Note

- When this function is set to "On", the monitor only enters the power saving mode when signals are not input from any PC.

Compatibility Mode

Settings: "On" / "Off"

If you want to avoid the following phenomena, set this function to "On":

- The positions of windows and icons are shifted when the monitor is turned off/on or has returned from the power saving mode.
- Even when operating a mouse or keyboard connected to the USB downstream port of the monitor, the PC does not return from sleep.
- When the power to the monitor is turned off, a device connected to the USB downstream port does not work, or power is not supplied to the connected device.

On-Screen Logo

Settings: "On" / "Off"

When the monitor is turned on, the EIZO logo and certification standard logo appears on the screen.

When this function is set to "Off", the logos do not appear.

Key Lock

Settings: "Off" / "Menu" / "All"

In order to prevent changes to settings, the operation switches on the front of the monitor can be locked.

- "Off" (default setting)
Enables all switches.
- "Menu"
Locks the  switch.
- "All"
Locks all switches except the power switch.

5 Troubleshooting

5.1 No Picture

Power indicator does not light up.

- Check whether the power cord is connected properly.
- Press .

Power indicator is lighting white.

- Increase "Brightness", "Contrast", or "Gain" in the Setting menu (see [Color \[▶ 16\]](#)).

Power indicator is lighting orange.

- Switch the input signal.
- Turn the setting "On" for "Compatibility Mode" on the "Administrator Settings" menu (see [Compatibility Mode \[▶ 25\]](#)).
- Move the mouse or press any key on the keyboard.
- Check whether the PC is turned on.

The message "No Signal" appears on the screen.

Example:

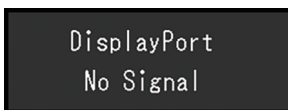

- The message shown above may appear as some PCs do not output the signal immediately after power-on.
- Check whether the PC is turned on.
- Check whether the signal cable is connected properly.
- Switch the input signal.
- Try setting "Auto Input Detection" in the "Administrator Settings" menu to "Off" and switching the input signal manually (see [Auto Input Detection \[▶ 25\]](#)).

The message "Signal Error" appears on the screen

Example:

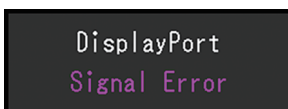

- Check whether the PC is configured to meet the resolution and vertical scan frequency requirements of the monitor (see [1.3 Supported Resolutions \[▶ 10\]](#)).
- Reboot the PC.
- Select an appropriate setting using the graphics board's utility. Refer to the User's Manual of the graphics board for details.

5.2 Imaging Problems (or Both Digital and Analog)

The screen is too bright or too dark.

- Use "Brightness" or "Contrast" in the Setting menu to adjust it (see [Color ▶ 16](#)). (The LCD monitor backlight has a limited life span. If the screen becomes dark or begins to flicker, contact your local EIZO representative.)
- If the screen is too bright, try changing the Auto EcoView setting to "On". The monitor detects the ambient brightness to adjust the screen brightness automatically (see [Auto EcoView ▶ 13](#)).

The brightness changes on its own.

- Try changing the Auto EcoView setting to "Off" (see [Auto EcoView ▶ 13](#)).
- Try changing the EcoView Optimizer 2 setting to "Off" (see [EcoView Optimizer 2 ▶ 13](#)).

Characters and images are blurred

- Check whether the PC is configured to meet the resolution and vertical scan frequency requirements of the monitor (see [1.3 Supported Resolutions ▶ 10](#)). For information on how to change your computer settings, refer to our web site (www.eizoglobal.com).
- When an image is displayed with a resolution other than recommended, the text and lines of the image may appear blurry. In this case, try adjusting "Sharpness" in the Setting menu (see [Sharpness ▶ 20](#)).
- Try setting the display magnification on the operating system to "100 %". When using multiple monitors, try setting the magnification of display to "100 %" on all monitors.

Afterimages appear.

- Afterimages are particular to LCD monitors. Avoid displaying the same image for a long time.
- Use the screen saver or power saving function to avoid displaying the same image for extended periods of time.
- An afterimage may appear even after a short time period has elapsed depending on the displayed image. To remove such a phenomenon, change the image or keep the power turned off for several hours.

Green / red / blue / white / dark dots remain on the screen.

- This is due to LCD panel characteristics and not a malfunction.

Interference patterns or pressure marks remain on the LCD panel.

- Leave the monitor with a white or black screen. The symptom may disappear.

Noise appears on the screen.

- In the Setting menu, set "Overdrive" to "Off" (see [Advanced Settings - Overdrive ▶ 18](#)).
- When inputting HDCP system signals, normal images may not be displayed immediately.

The positions of windows and icons are shifted when the monitor is turned off/on or when restored from power saving mode.

- Turn the setting "On" for "Compatibility Mode" on the "Administrator Settings" menu (see [Compatibility Mode \[▶ 25\]](#)).

Images are not displayed over the entire area of the screen.

- Try changing "Picture Expansion" in the Setting menu (see [Picture Expansion \[▶ 19\]](#)).
- Check whether the setting for the resolution of the PC matches the resolution of the monitor.

5.3 Imaging Problems (Analog only)

Screen is misaligned

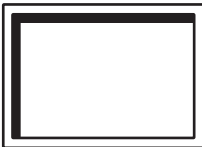

- Use "Hor. Position" or "Ver. Position" in the Setting menu to adjust the positioning of the screen (see [Analog Adjustment - Hor. Position / Ver. Position \[▶ 21\]](#)).
- If the graphics board's utility has a function to change the position of the image, use that function to adjust the position.

Vertical lines appear on the screen / Part of the screen is flickering



- Try adjusting "Clock" in the Setting menu (see [Analog Adjustment - Clock \[▶ 20\]](#)).

The whole screen appears to flicker or bleed



- Try adjusting "Phase" in the Setting menu (see [Analog Adjustment - Phase \[▶ 20\]](#)).

5.4 Other Problems

The Setting menu does not appear.

- Check whether the operation switch lock function is active (see [Key Lock \[▶ 25\]](#)).

Cannot select items in the Setting menu.

- Items that are displayed with gray text cannot be changed.
- "Color" items cannot be changed in some color modes. Setting the color mode to "User 1" or "User 2" will allow you to change all items (see [Color \[▶ 16\]](#)).

No audio output

- This product does not contain speakers.

USB peripheral devices connected to the monitor do not work.

- Check whether the USB cable is correctly connected between the PC and the USB upstream port on the monitor.
- Check whether the peripheral device is correctly connected to the USB downstream port on the monitor.
- Check whether the power consumption of peripheral devices is within 2.5 W (5 V / 500 mA).
- Try using a different USB downstream port on the monitor.
- Try using a different USB port on the PC.
- Check whether the device drivers of the peripheral devices are up-to-date.
- Reboot the PC.
- When "Compatibility Mode" is set to "Off" in the "Administrator Settings" menu and the power of the monitor is turned off, devices connected to the USB downstream port are not operational. Change the setting for "Compatibility Mode" to "On" (see [Compatibility Mode \[▶ 25\]](#)).
- If the peripheral devices work correctly when they are directly connected to the PC, contact your local EIZO representative.
- Check the PC's BIOS (UEFI) setting for USB when using Windows. (See the manual of the PC for details.)
- Check if the operating system of the PC is up-to-date.
- If you are using macOS Ventura (13), select "Allow" in the "Allow accessory to connect?" message window that appears when connecting via USB.

Power indicator is flashing orange

- This issue may occur when a PC is connected to the DisplayPort connector. Use a signal cable recommended by us for the connection. Turn the monitor off and on.

Even when operating a mouse or keyboard connected to the USB downstream port of the monitor, the PC does not return from sleep.

- Turn the setting "On" for "Compatibility Mode" on the "Administrator Settings" menu (see [Compatibility Mode \[▶ 25\]](#)).

6 Reference

6.1 Attaching an Optional Monitor Arm

An optional arm (or optional stand) can be attached by removing the stand section. Please refer to our web site for optional arms (or optional stands) that are supported.

(www.eizoglobal.com)

When attaching an arm or stand, the installable orientations and movement range (tilt angle) are as follows:

- Orientation

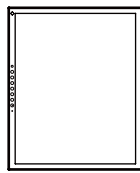

Portrait (Right 90°)

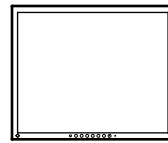

Landscape

- Movement range (tilt angle)

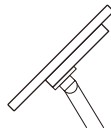

Up: 45°

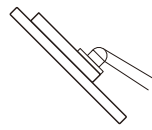

Down: 45°

Attention

- When attaching an arm or stand, follow the instructions of the respective User's Manual.
- When using an arm or stand by another manufacturer, confirm the following points in advance and select one that conforms to the VESA standard:
 - Clearance between screw holes: 100 mm x 100 mm
 - Plate thickness: 2.6 mm
 - Strong enough to support weight of the monitor unit (excluding the stand) and attachments such as cables
- Connect the cables after attaching an arm or stand.
- Do not move the removed stand up and down. Doing so may result in injury or device damage.
- The monitor, arm, and stand are heavy. Dropping them may result in injury or equipment damage.
- Check periodically that the screws are tight enough. If the screws are not tight enough, the monitor may come unattached. This may be the cause of injury or damage.

1. Lay the LCD monitor on a soft cloth spread over a stable and flat surface with the LCD panel surface facing down.
2. Remove the stand.
Prepare a screwdriver.
Use the screwdriver to remove the screws that secure the unit to the stand.

3. Attach the arm or stand to the monitor.

For installation, use commercially available screws that meet the following conditions:

- Nominal diameter: M4
- Length: Between 7.7 mm and 10.5 mm (if using washers, add the washer thickness)

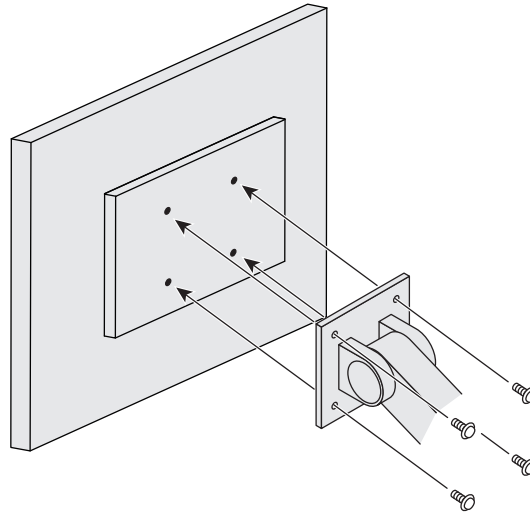

6.2 Connecting Multiple PCs

This product can be connected to multiple PCs and allows you to switch between the connections for display.

Connection Examples

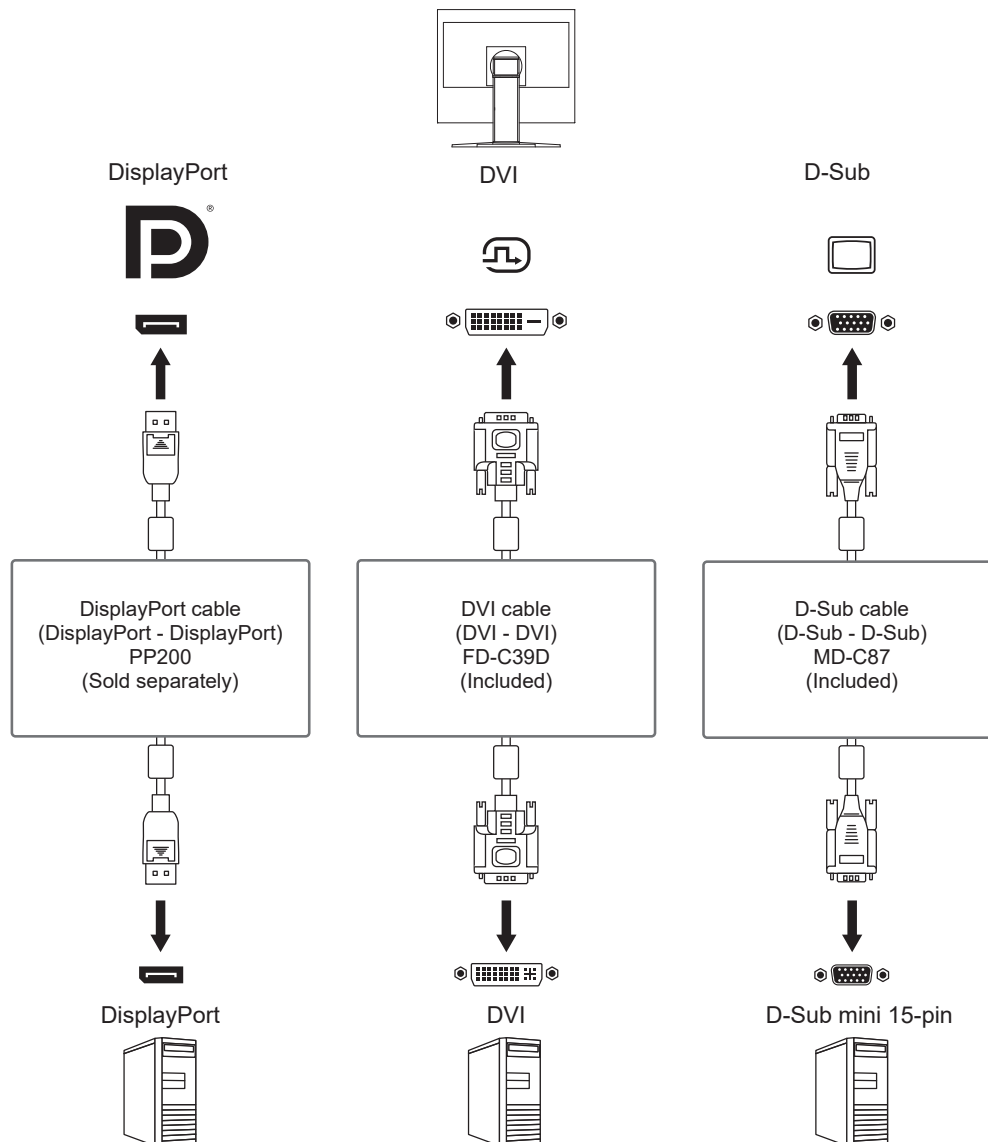

Note

- You can select the input signal to display using the operation switch () on the front of the monitor. For details, see [2.2 Switching Input Signals](#) [▶ 11].
- This product provides a function that automatically recognizes the connector through which PC signals are input, and displays images on the screen accordingly. For details, see [Auto Input Detection](#) [▶ 25].

6.3 Using the USB Hub Function

This monitor is equipped with a USB hub. It functions as a USB hub when connected to a USB-compatible PC, allowing the connection of peripheral USB devices.

1. Connect the USB cable.
2. If necessary, connect a mouse, keyboard, or other device to the USB downstream port.

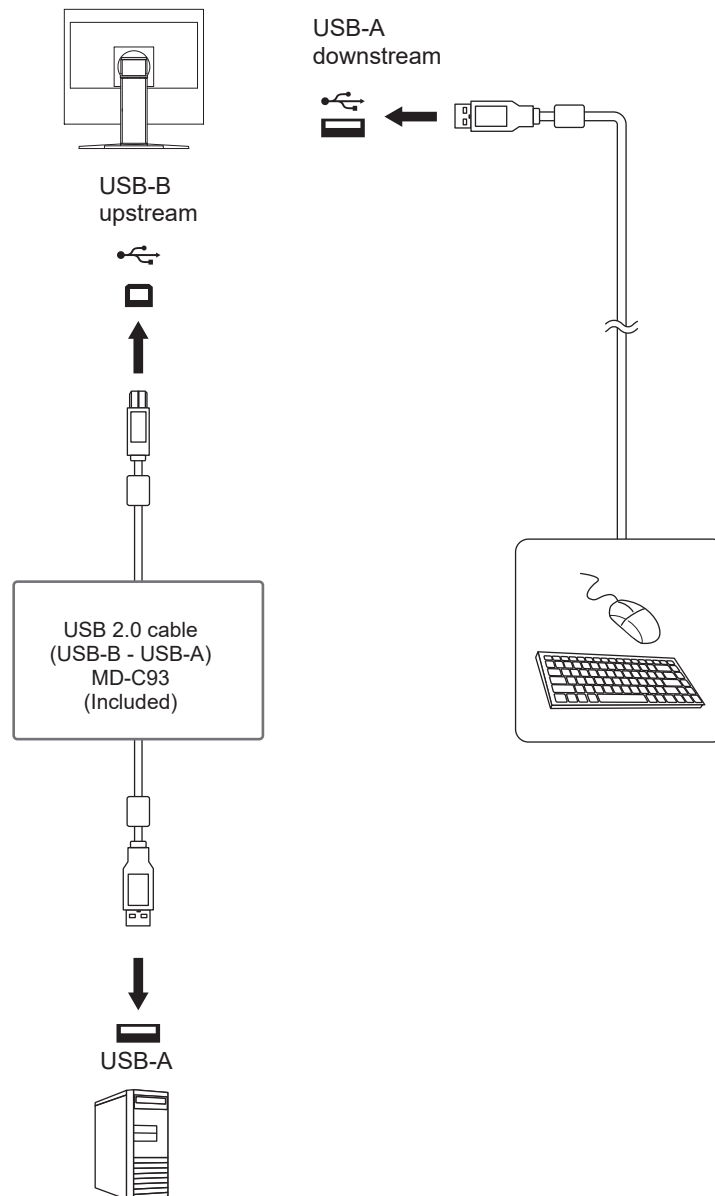
**Attention**

- This function may not work depending on the PC you are using, your OS, and your peripheral devices. Contact the manufacturer of each device for information about USB compatibility.
- Even when the monitor is in power saving mode, devices connected to the USB downstream port are operational. For this reason, the power consumption of the monitor varies depending on the connected devices, even in power saving mode.
- When [Compatibility Mode \[▶ 25\]](#) is set to "Off" and the power of the monitor is turned off, devices connected to the USB downstream port are not operational.

6.4 Specifications

6.4.1 LCD Panel

Type	IPS (Anti-Glare)	
Backlight	LED	
Size	21.3" (54.0 cm)	
Resolution	1600 dots x 1200 lines	
Display Size (H x V)	432.0 mm x 324.0 mm	
Pixel Pitch	0.270 mm x 0.270 mm	
Display Colors	8-bit colors	16.77 million colors
Viewing Angle (H / V, typical)	178° / 178°	
Response Time (typical)	Black -> White -> Black	20 ms
	Middle Tone Area	6 ms (overdrive setting: Enhanced)

6.4.2 Video Signals

Input Terminals	DisplayPort (HDCP 1.3 compatible) x 1, DVI-D (HDCP 1.4 compatible, Single Link) x 1, D-Sub mini 15-pin x 1	
Digital Scanning Frequency (H / V ^{*1})	DisplayPort	Horizontal: 31 kHz - 76 kHz / Vertical: 59 Hz - 61 Hz, 69 Hz - 71 Hz (at 720 x 400)
	DVI-D	
Analog Scanning Frequency (H / V ^{*1})	D-sub	Horizontal: 24 kHz - 80 kHz / Vertical: 49 Hz - 76 Hz
Frame Synchronization Mode	59 Hz – 61 Hz	
Max. Dot Clock	162 MHz	

*1 The vertical scan frequency supported varies according to the resolution. For more information, see [1.3 Supported Resolutions \[▶ 10\]](#).

6.4.3 USB

Port	Upstream	USB-B (USB 2.0) x 1
	Downstream	USB-A (USB 2.0) x 2
Standard	USB Specification Revision 2.0	
Communication Speed	480 Mbps, 12 Mbps, 1.5 Mbps	
Power supply	Downstream ^{*1}	USB-A (USB 2.0): Maximum of 500 mA per port

*1 Power will not be supplied if the PC and monitor are not connected via USB.

6.4.4 Power

Input	100 - 240 VAC ±10 %, 50 / 60 Hz, 0.75 - 0.40 A
Maximum Power Consumption	42 W or less
Power Save Mode	0.5 W or less (USB device not connected, external load not connected, only one video signal input)
Standby Mode (standard value)	0.3 W (external load not connected, only one video signal input)

6.4.5 Physical Specifications

Dimensions	465.0 mm x 453.0 mm – 535.0 mm x 208.5 mm (W x H x D) (Tilt: 0°)
------------	--

Dimensions (without stand)	465.0 mm x 361.0 mm x 64.0 mm (W x H x D)
Net Weight	Approx. 8.1 kg
Net Weight (without stand)	Approx. 5.1 kg
Height Adjustment Range	82.0 mm
Tilt	Up 40°, down 0°
Swivel	70°
Vertical Rotation	Right 90°

6.4.6 Operating Environmental Requirements

Temperature	5 °C – 35 °C
Humidity	20 % – 80 % R.H. (no dew condensation)
Air Pressure	540 hPa – 1060 hPa

6.4.7 Transportation / Storage Environmental Requirements

Temperature	-20 °C – 60 °C
Humidity	10 % – 90 % R.H. (no dew condensation)
Air Pressure	200 hPa – 1060 hPa

6.4.8 Accessories

For the latest information about accessories, refer to our web site.

(www.eizoglobal.com)

Appendix

Trademark

The terms HDMI, HDMI High-Definition Multimedia Interface, HDMI trade dress and the HDMI Logos are trademarks or registered trademarks of HDMI Licensing Administrator, Inc. DisplayPort, the DisplayPort Compliance Logo and VESA are trademarks of the Video Electronics Standards Association in the United States and other countries.

The SuperSpeed USB Trident Logo is a registered trademark of USB Implementers Forum, Inc.



The SuperSpeed USB Power Delivery Trident Logos are trademarks of USB Implementers Forum, Inc.



USB Type-C and USB-C are registered trademarks of USB Implementers Forum, Inc.

DICOM is the registered trademark of the National Electrical Manufacturers Association for its standards publications relating to digital communications of medical information.

Kensington and Microsaver are registered trademarks of ACCO Brands Corporation.

Thunderbolt is a trademark of Intel Corporation in the United States and/or other countries.

Microsoft and Windows are registered trademarks of Microsoft Corporation in the United States and other countries.

Adobe is a registered trademark of Adobe in the United States and other countries.

Apple, macOS, Mac OS, OS X, macOS Sierra, Macintosh and ColorSync are trademarks of Apple Inc.

ENERGY STAR is a registered trademark of the United States Environmental Protection Agency in the United States and other countries.

EIZO, the EIZO Logo, ColorEdge, CuratOR, DuraVision, FlexScan, FORIS, RadiCS, RadiForce, RadiNET, Raptor, and ScreenManager are registered trademarks of EIZO Corporation in Japan and other countries.

ColorEdge Tablet Controller, ColorNavigator, EcoView NET, EIZO EasyPIX, EIZO Monitor Configurator, EIZO ScreenSlicer, G-Ignition, i•Sound, Quick Color Match, RadiLight, Re/Vue, SafeGuard, Screen Administrator, Screen InStyle, ScreenCleaner, SwitchLink, and UniColor Pro are trademarks of EIZO Corporation.

All other company names, product names, and logos are trademarks or registered trademarks of their respective owners.

License

The bitmap font used for this product is designed by Ricoh Industrial Solutions Inc.

