

STREAMING VIDEO MIXER V-02HD MK II



PC app "V-02HD MK II Utility," "V-02HD MK II RCS"

You can use the "V-02HD MK II Utility" PC app to back up the settings of the V-02HD MK II to a USB-connected computer, and restore backed-up settings when needed.

Use the "V-02HD MK II RCS" PC app to remotely control the V-02HD MK II from a computer connected via USB.

- You can download "V-02HD MK II Utility" and "V-02HD MK II RCS" from the Roland website (<https://proav.roland.com/>) (* "V-02HD MK II RCS" will be released in winter 2021)

iPad app "V-02HD MK II Remote"

You can connect the V-02HD MK II to your iPad via USB, and remotely control the V-02HD MK II unit from the "V-02HD MK II Remote" iPad app.

- You can download the "V-02HD MK II Remote" from the App Store at no cost.
- The app is supported by the V-02HD MK II's system program version 1.03 and later.

Contents

Operating Guide (Panel Description)	2
Front Panel	2
Rear Panel	4
Connecting a Footswitch	6
Basic Operations	7
Turning the Power On/Off	7
Operating the Menu	7
Video Input/Output Settings	8
List of Compatible Video Formats	8
Setting the Output Format	8
Specifying the Input Format (EDID)	9
Adjusting Output Video	9
Adjusting the Input Video	10
Outputting the Program Video from the PREVIEW OUT Connector	10
Two Inputs Sharing One Video Input (Shared Input)	11
Inputting Copy-Protected (HDCP) Video	11
Video Operations	12
Using Mix/Wipe to Switch Video (MIX/WIPE)	12
Using Picture-In-Picture to Composite Video (PinP)	13
Using a Key to Composite Video (KEY)	14
Compositing a Logo or Image (Luminance Key)	14
Compositing a Subject and Background (Chroma Key)	16
Applying a Visual Effect to the Video (VFX)	18
Applying a Fade to the Program Output Video (Output Fade)	19
Using a Captured Still Image	20
Audio Operations	22
Adjusting the Input Gain (Sensitivity)	22
Adjusting the Volume Level	23
Applying Effects to Input Audio	24
Applying Reverb	26
Applying Effects to Output Audio	26
Silencing Only Specific Audio (Mute)	27
Checking a Specific Audio Input (Solo)	27
Interlinking Audio Output to Video Switching (Audio Follow)	28
Outputting AUX Bus Audio	29
Assigning the AUX bus	29
Sending Audio to the AUX bus	29

Live Streaming	30
Outputting Video/Audio to a Computer for Streaming	30
Other Features	31
Saving/Recalling Settings (Preset Memory)	31
Using a Footswitch	32
Using an Expression Pedal	34
Preventing Unintended Operation (Panel Lock)	36
Returning to the Factory Settings (Factory Reset)	36
Switching Video Automatically (Auto Switching)	37
Auto Switching Operation Modes	37
Specifying the Operation Mode	37
Menu List	38
1: VIDEO INPUT	38
2: VIDEO OUTPUT	39
3: TRANSITION TIME	40
4: MIX/WIPE	40
5: PinP	40
6: KEY	41
7: VFX	42
8: AUDIO INPUT	44
9: AUDIO OUTPUT	47
10: AUDIO FOLLOW	49
11: PRESET MEMORY	49
12: CTL/EXP	50
13: CAPTURE IMAGE	52
14: SYSTEM	52
Shortcut List	55
MIDI Implementation	56
Appendix	70
Block Diagram	70
Dimensions	72
Troubleshooting	73
Main Specifications	74

Operating Guide (Panel Description)

Front Panel

■ Fading video and audio in or out (p. 19)

■ Outputting a captured still image (p. 20)

Turn counterclockwise from the center

The program output video and audio fade in/out simultaneously. The video fades to a black screen.

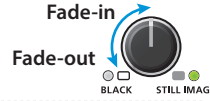

Turn clockwise from the center

If you turn the knob all the way clockwise, the captured still image is output to preview/program as a cut (instant switching).

Center

Normal output.

- The settings described above are the factory defaults. You can also assign other functions to the [OUTPUT FADE] knob.

[OUTPUT FADE] knob

The indicators located at the left and right of the [OUTPUT FADE] knob show the status.

Left indicator

Blinking red	Fading in/out
Lit red	Fade-out completed

Right indicator

Lit green	Unit contains still image
Lit red	Still image is being output
Dark	Unit contains no still image

■ Selecting a Video Effect [TYPE] button

You can select the effect that's applied to the video. The video effect is switched each time you press the button. The indicator of the selected video effect is lit.

Transition effects (p. 12)

MIX	The two videos are mixed as the transition occurs.
WIPE	The next video moves across to replace the original video.

Composition effects (p. 13, 14, 16)

Picture-in-picture (PinP)	The inset screen (a separate small screen) is shown on top of the background video.
KEY	A portion of the video is made transparent, and composited with the background video.



■ Switching video (p. 12)

[1] [2] buttons, Video fader

[1] [2] buttons

Switch between the videos being input to INPUT 1 and 2, and send them to the program output.

[1] [2] buttons	Status
Lit red	Program output video
Lit green	Preview output video (standby video)

Video fader

Manually switch between the videos being input to INPUT 1 and 2, and send them to the program output.

Transition indicators (both sides of the fader)

The lit indicator shows the video that is being output as the program.

■ Compositing video (p. 13, 14, 16)

[1] [2] buttons, Video fader

[1] button (Lit yellow)/

Transition indicators (both sides of the fader)

Selects the background video when compositing video. A transition indicator (left or right) is lit to indicate the selected background video.

[2] button/Video fader

Outputs the resulting composited video as the program. The inset screen of picture-in-picture or the key video or image for key compositing is revealed or removed.

[2] button	Status
Lit red	Outputting the composited result as the program
Dark	Outputting only the background video as the program

■ **Adjusting the video effect (p. 12–18)**

[CONTROL 1] [CONTROL 2] knobs

These adjust the video effect or visual effect (VFX).

- If the visual effect is on ([VFX] button lit), these knobs control the visual effect.
- Operate this while holding down the [VFX] button to target the audio effect.

■ **Applying a Visual Effect to the Video (p. 18)**

[VFX] button

Turns the visual effect on/off.

When on, the [VFX] button is lit.

- You can adjust the audio effect by holding down the button and operating the [CONTROL 1] and [CONTROL 2] knobs.



■ **Operating the Menu (p. 7)**

[MENU] button, [VALUE] knob

[MENU] button

Turning this button on (lit) makes a menu appear on the display that is connected to the PREVIEW OUT connector. If you've moved to a lower-level item of the menu, this button returns you to the next higher level. If the highest menu level is already shown, the button closes the menu.

[VALUE] knob

Turning: This selects a menu item or changes a setting value.
Pressing: This accepts the selected menu item or applies changes to a setting.

What is the program output?

This is the video output that reflects all processing such as video compositing and visual effects. It is output from the PROGRAM OUT connector.

This is the video that is seen by the people who are watching the live stream or presentation.

Tripod mounting socket (bottom panel)

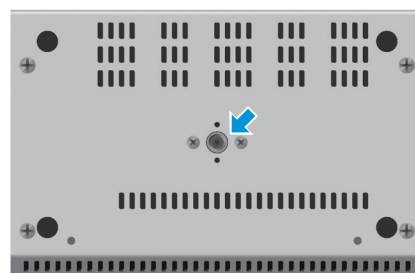

This is used when attaching the V-02HD MK II to a commercially available camera tripod. The socket is threaded for a 1/4" screw.

Rear Panel

* To prevent malfunction and equipment failure, always turn down the volume, and turn off all the units before making any connections.

DC IN jack

Connect the included AC adaptor to this jack.

* Use the cord hook to secure the cord of the AC adaptor as shown in the illustration.

For information on how to attach the cord hook, refer to "Attaching the Cord Hook" (p. 5).

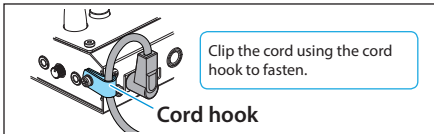

* Place the AC adaptor so the side with the indicator (see illustration) faces upwards and the side with textual information faces downwards. The indicator will light when you plug the AC adaptor into an AC outlet.

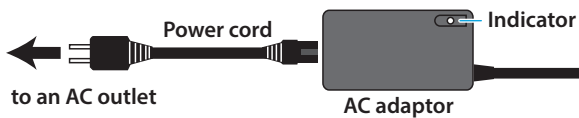

PROGRAM OUT connector

This outputs the resulting mixed video (the program video). Here you can connect a display, projector, or video recorder that is equipped with an HDMI input connector.



HDMI cable

Ground terminal

Connect this to an external earth or ground if necessary.

USB STREAM port (USB Type-C®)

Connect your computer here. This port outputs the resulting video/audio mix from the V-02HD MK II to your computer. Use this for live broadcasting of video/audio and for similar applications. This is also used to input audio played on your computer to the V-02HD MK II.

* If you are outputting HD video via USB, connect this to a USB port on your computer that supports USB 3.0.
 * If you connect via an extension cable or a USB hub, the computer might not recognize the V-02HD MK II. We recommend that you connect the V-02HD MK II directly to your computer.

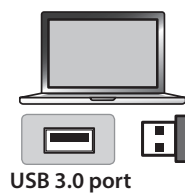

USB3.0 cable

HDMI cable

CTL/EXP jack (TRS phone)

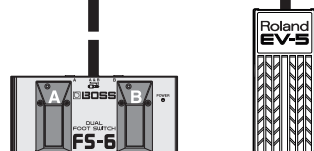

Connect an expression pedal (sold separately: EV-5, etc.) or footswitch (sold separately: BOSS FS-6, etc.). This is used when using your foot to control operations such as video switching. For details on connecting a footswitch, refer to "Connecting a Footswitch" (p. 6).

* Use only the specified expression pedal (EV-5, BOSS FV-500L, or FV-500H sold separately). By connecting any other expression pedals, you risk causing malfunction and/or damage to the unit.

PREVIEW OUT connector



HDMI input connector

This outputs the preview video (the standby video). Connect this to a display that is equipped with an HDMI input connector.

• The V-02HD MK II menu is shown on the display that's connected to the PREVIEW OUT connector.

* Do not block the ventilation openings (the slits located on the front and side panels, etc.). If the ventilation openings are blocked, the internal temperatures may rise, causing malfunctions due to excessive heat.

AUDIO IN 1, 2 jacks (stereo mini)

These input audio. Connect a mic, audio mixer, CD players, or other such audio equipment.

* Plug-in Power type mics are supported.

Audio output connectors

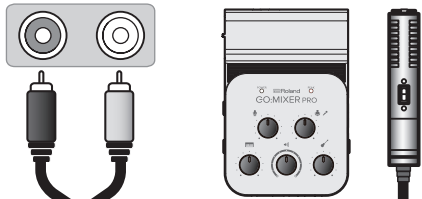

Plug-in Power settings

If you're using a Plug-in Power type mic, turn plug-in power on. Press the [SETUP] button to access the "AUDIO INPUT" → "AUDIO IN 1" or "AUDIO IN 2" settings, and set "PLUG-IN POWER" to "ON."

NOTE

When connecting a dynamic mic or a mic that does not support Plug-in Power, be sure to turn Plug-in Power off. If Plug-in Power is on when such a mic is connected, malfunctions will occur.

PHONES () jack (stereo mini)

Connect headphones here.



[PHONES] knob

Adjusts the volume of the headphones.

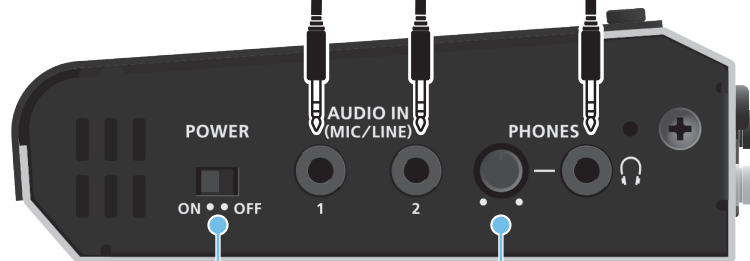

Turning the Power On/Off (p. 7)

[POWER] switch

This switch turns the power on/off.

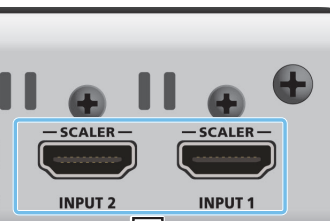

HDMI cable

INPUT 1, 2 connectors

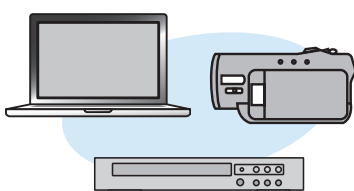

HDMI output connector

These input video. Connect these to a video camera, video device such as a BD player, or a computer that is equipped with an HDMI output connector.

Attaching the Cord Hook

Attach the included cord hook. The cord hook is used to secure the cord of the AC adaptor.

1. Remove the screw (one) indicated in the illustration.

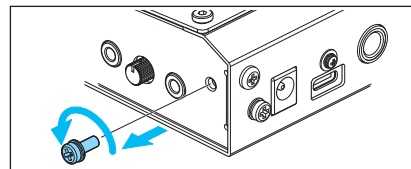

2. Using the screw that you removed in step 1, attach the cord hook as shown in the illustration.

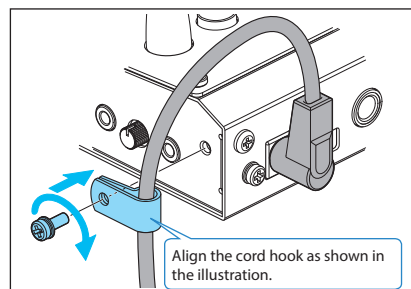

Align the cord hook as shown in the illustration.

Connecting a Footswitch

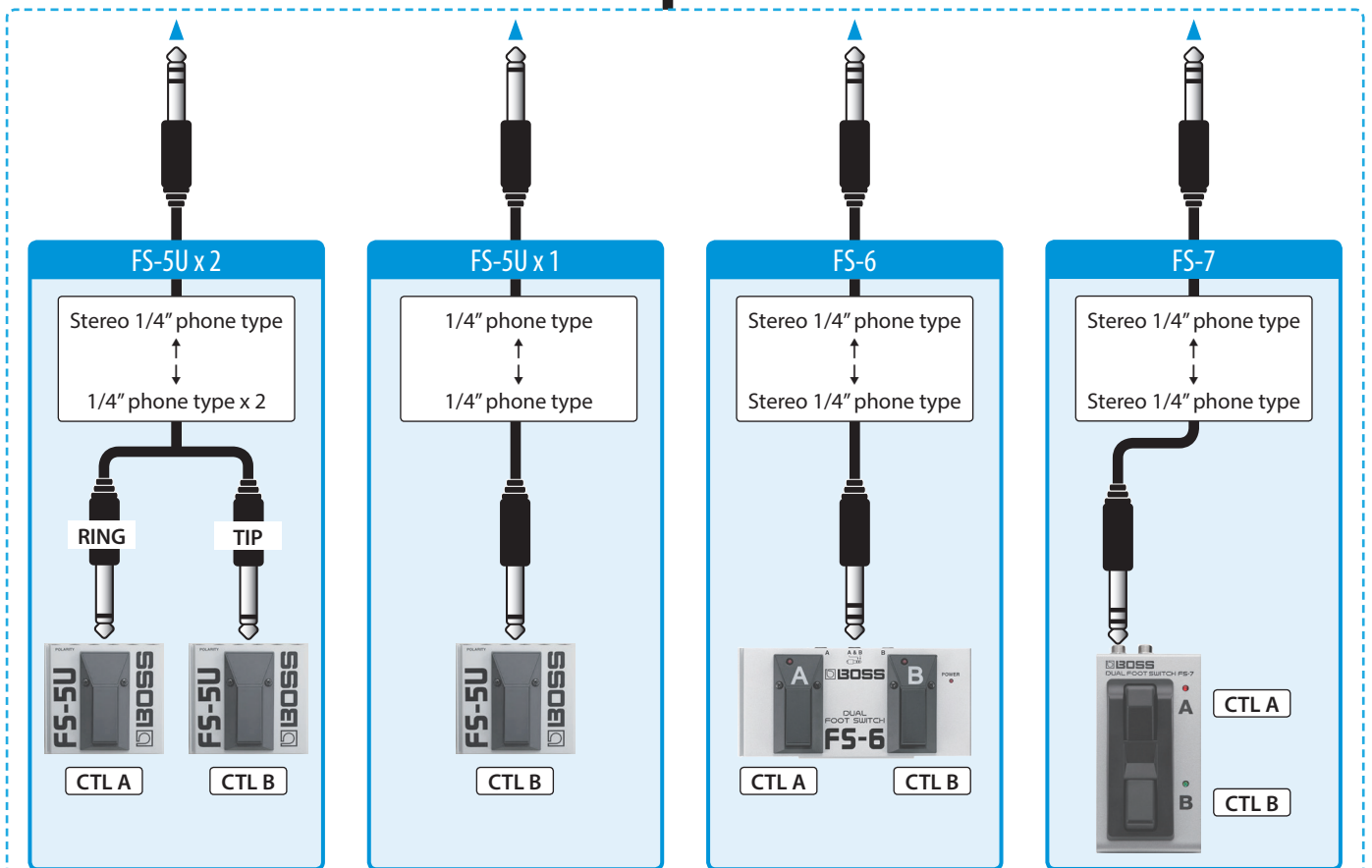
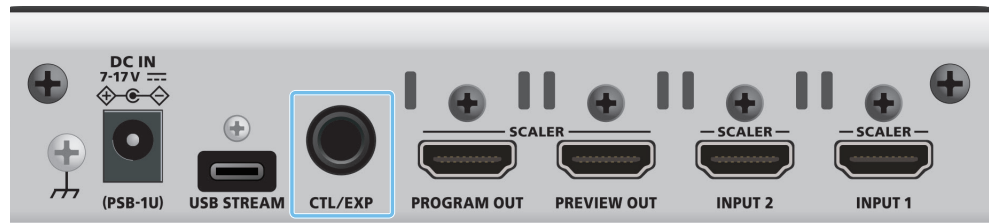

MODE/POLARITY switch

FS-5U

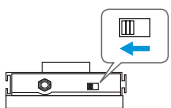

FS-6

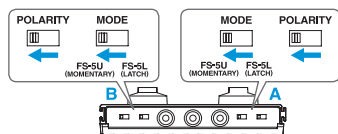

FS-7

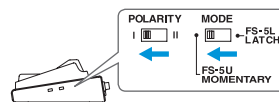

NOTE

The BOSS FS-6's A, B, and A&B jacks also act as the power switch. The power turns on when you insert a plug into the jack, and turns off when you remove the plug.

To prevent the batteries from running down, remove the plugs from the jacks when you're not using the BOSS FS-6.

Basic Operations

Turning the Power On/Off

* Before turning the unit on/off, always be sure to turn the volume down. Even with the volume turned down, you might hear some sound when switching the unit on/off. However, this is normal and does not indicate a malfunction.

Turning the power on

1. Make sure that all devices are powered-off.
2. Turn on the V-02HD MK II's [POWER] switch.

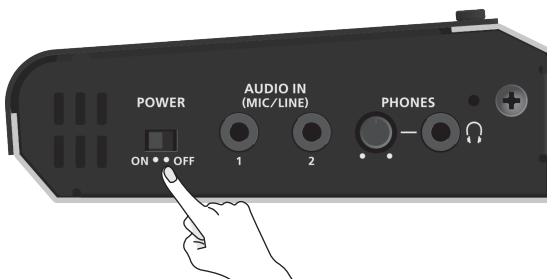

3. Turn on the power in the order of source devices → output devices.

Turning the power off

1. Turn off the power in the order of output devices → source devices.
2. Turn off the V-02HD MK II's [POWER] switch.

About the Auto Off function

The power to the V-02HD MK II turns off automatically when all of the following states persist for 240 minutes (Auto Off function).

- No operation performed on the V-02HD MK II
- No audio or video input
- No equipment is connected to the PROGRAM OUT/PREVIEW OUT connectors

If you do not want the power to be turned off automatically, disengage the Auto Off function. Press the [MENU] button → "SYSTEM" → set "AUTO OFF" to "OFF."

- * Unsaved data is lost when the power turns off. Before turning the power off, save the data that you want to keep.
- * To restore power, turn the power on again.

Operating the Menu

Here's how to access the menu, and make video/audio settings and settings for the V-02HD MK II itself. The menu is shown on the display that's connected to the PREVIEW OUT connector.

1. Press the [MENU] button to display the MENU screen.

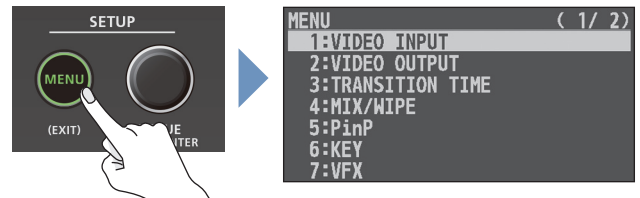

The menu is organized into functions.

2. Turn the [VALUE] knob to move the cursor to the menu item that you want to change, and then press the [VALUE] knob.

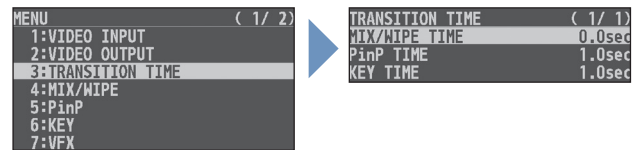
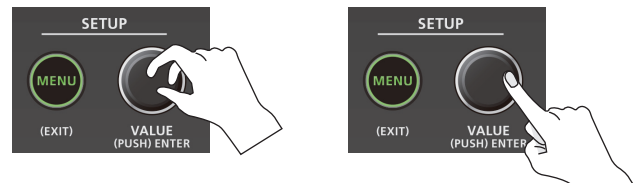

3. Repeat step 2 as needed.

Pressing the [MENU] button moves you back one level higher.

4. Turn the [VALUE] knob to change the setting value, and then press the [VALUE] knob.

MEMO

- By turning the [VALUE] knob while pressing it, you can change the value more greatly.
- Long-pressing the [VALUE] knob returns the current menu item you're setting to its default value.

5. Press the [MENU] button several times to close the menu.

Video Input/Output Settings

List of Compatible Video Formats

Input video formats

Frame rate	
When set to "59.94 Hz"	When set to "50 Hz"
480/59.94i	576/50i
480/59.94p	576/50p
720/59.94p	720/50p
1080/59.94i	1080/50i
1080/59.94p	1080/50p
1080/60p	1080/25p
1080/29.97p	1080/23.98p
1080/30.00p	1080/24p
1080/23.98p	1080/25p
1080/24p	VGA (640 x 480/60 Hz)
1080/29.97p	SVGA (800 x 600/60 Hz)
VGA (640 x 480/60 Hz)	XGA (1024 x 768/60 Hz)
SVGA (800 x 600/60 Hz)	WXGA (1280 x 800/60 Hz)
XGA (1024 x 768/60 Hz)	FWXGA (1366 x 768/60 Hz)
WXGA (1280 x 800/60 Hz)	SXGA (1280 x 1024/60 Hz)
FWXGA (1366 x 768/60 Hz)	SXGA+ (1400 x 1050/60 Hz)
SXGA (1280 x 1024/60 Hz)	UXGA (1600 x 1200/60 Hz)
SXGA+ (1400 x 1050/60 Hz)	WUXGA (1920 x 1200/60 Hz)
UXGA (1600 x 1200/60 Hz)	
WUXGA (1920 x 1200/60 Hz)	

Audio input format HDMI: Linear PCM, 24 bits/48 kHz, 2 ch

Output video formats

Frame rate	
When set to "59.94 Hz"	When set to "50 Hz"
480/59.94p	576/50p
720/59.94p	720/50p
1080/29.97p	1080/25p
1080/59.94i	1080/50i
1080/59.94p	1080/50p
SVGA (800 x 600/60 Hz)	SVGA (800 x 600/75 Hz)
XGA (1024 x 768/60 Hz)	XGA (1024 x 768/75 Hz)
WXGA (1280 x 800/60 Hz)	WXGA (1280 x 800/75 Hz)
FWXGA (1366 x 768/60 Hz)	FWXGA (1366 x 768/75 Hz)
SXGA (1280 x 1024/60 Hz)	SXGA (1280 x 1024/75 Hz)
SXGA+ (1400 x 1050/60 Hz)	SXGA+ (1400 x 1050/75 Hz)
UXGA (1600 x 1200/60 Hz)	UXGA (1600 x 1200/60 Hz)
WUXGA (1920 x 1200/60 Hz)	WUXGA (1920 x 1200/60 Hz)
HD (1280 x 720/60 Hz)	HD (1280 x 720/60 Hz)
FHD (1920 x 1080/60 Hz)	FHD (1920 x 1080/60 Hz)

Audio input format HDMI: Linear PCM, 24 bits/48 kHz, 2 ch

Setting the Output Format

Here's how to specify the output format as appropriate for the device that's connected.

NOTE

If the display does not support the V-02HD MK II's output format, the image might not be shown correctly.

What should you do if you accidentally specify an output format that the connected display doesn't support?

While holding down the [1] and [2] buttons, turn on the power. This initializes the output format settings.

1. [MENU] button → "VIDEO OUTPUT" → select "SCALING," and press the [VALUE] knob.

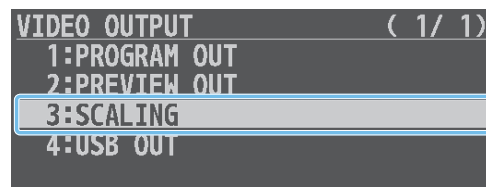

2. Use the [VALUE] knob to select "FORMAT," and press the [VALUE] knob.

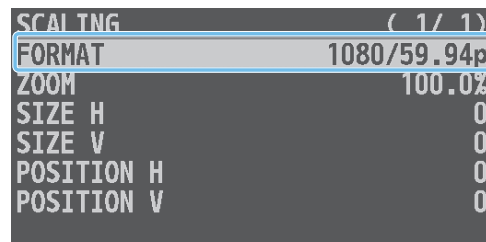

3. Use the [VALUE] knob to set the output format.
4. Press the [VALUE] knob.
The output format switches.
5. Press the [MENU] button several times to close the menu.

Specifying the Input Format (EDID)

With the factory settings, EDID is set to "INTERNAL" (the unit transmits EDID information for all formats that it is able to input).

Change this setting if you want EDID information for a specific input format to be sent to a source device.

What is EDID?

EDID is data that is transmitted from the V-02HD MK II to the source device when the V-02HD MK II is connected to a source device. EDID contains data such as the formats that can be input to the V-02HD MK II (resolution, color space, color depth) and audio information.

Based on the EDID information that the source device receives, it will output the most appropriate video format to the V-02HD MK II.

1. [MENU] button → "VIDEO INPUT" → select "INPUT 1" or "INPUT 2," and press the [VALUE] knob.

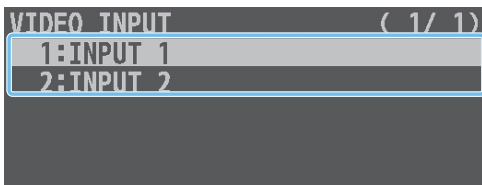

2. Use the [VALUE] knob to select "EDID," and press the [VALUE] knob.

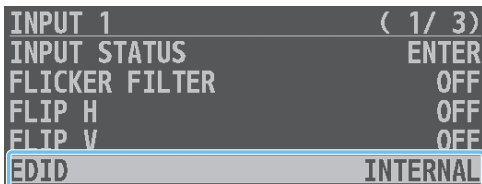

3. Use the [VALUE] knob to set the input format (EDID), and press the [VALUE] knob.

The input format (EDID) switches.

4. Press the [MENU] button several times to close the menu.

Adjusting Output Video

Here's how to adjust the output image appropriately for the device that's receiving the V-02HD MK II's output.

1. [MENU] button → "VIDEO OUTPUT" → select "PROGRAM OUT" or "PREVIEW OUT," and press the [VALUE] knob.

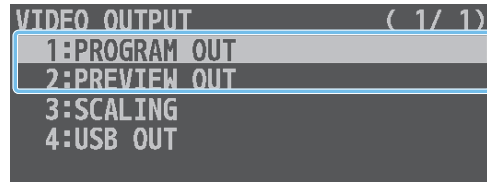

2. Use the [VALUE] knob to select a menu item and press the [VALUE] knob.



Menu item	Explanation
COLOR SPACE	Specifies the color space (system for representing colors in video).
DVI-D/HDMI SIGNAL	Specifies the output mode for HDMI output.
BRIGHTNESS	Adjusts the brightness.
CONTRAST	Adjusts the contrast.
SATURATION	Adjusts the saturation.
RED	Adjusts the red level.
GREEN	Adjusts the green level.
BLUE	Adjusts the blue level.

3. Use the [VALUE] knob to change the value, and press the [VALUE] knob.

4. Repeat steps 2–3 as necessary.

5. Press the [MENU] button several times to close the menu.

MEMO

You can output a test pattern, useful for adjusting the image quality of a display. Use the SYSTEM menu item "TEST PATTERN" to specify the test pattern that is output.

Adjusting the Input Video

Here's how to adjust the character and scaling of the video that's input to INPUT 1 and 2.

1. [MENU] button → "VIDEO INPUT" → select "INPUT 1" or "INPUT 2," and press the [VALUE] knob.



2. Use the [VALUE] knob to select a menu item and press the [VALUE] knob.

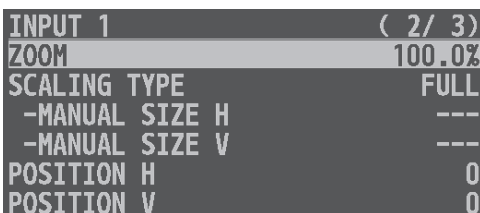

Menu item	Explanation
FLICKER FILTER	If this is "ON," flickering is reduced.
FLIP H	If this is "ON," the video is input with left and right flipped.
FLIP V	If this is "ON," the video is input with top and bottom flipped.
ZOOM	Adjusts the zoom ratio.
SCALING TYPE	Specifies the scaling type.
MANUAL SIZE H (*1)	Adjusts the horizontal size.
MANUAL SIZE V (*1)	Adjusts the vertical size.
POSITION H	Adjusts the display position in the horizontal direction.
POSITION V	Adjusts the display position in the vertical direction.
BRIGHTNESS	Adjusts the brightness.
CONTRAST	Adjusts the contrast.
SATURATION	Adjusts the saturation.
RED	Adjusts the red level.
GREEN	Adjusts the green level.
BLUE	Adjusts the blue level.

(*1) This is valid when "SCALING TYPE" is set to "MANUAL."

3. Use the [VALUE] knob to change the value, and press the [VALUE] knob.
4. Repeat steps 2–3 as necessary.
5. Press the [MENU] button several times to close the menu.

Outputting the Program Video from the PREVIEW OUT Connector

Here's how you can output the program video to the display that's connected to the PREVIEW OUT connector.

This can be useful in situations such as live distribution, since the same video as seen by the viewers can be shown on a different display that is used by the performers to monitor themselves.

1. [MENU] button → "VIDEO OUTPUT" → select "PREVIEW OUT," and press the [VALUE] knob.

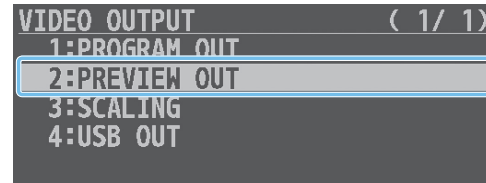

2. Use the [VALUE] knob to select "OUTPUT ASSIGN," and press the [VALUE] knob.

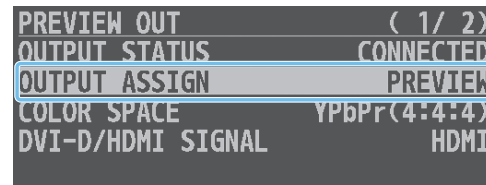

3. Use the [VALUE] knob to set it to "PROGRAM" and press the [VALUE] knob.

Menu item	Explanation
PROGRAM	Output the program video.
PREVIEW	Output the preview video (standby video).

4. Press the [MENU] button several times to close the menu.

Two Inputs Sharing One Video Input (Shared Input)

You can share the video input of INPUT 1 so that its video is input to INPUT 2.

For example, even in a situation where there is only one camera, this function lets you

- Specify zoom out for INPUT 1
- Specify a zoom setting for INPUT 2 that is sharing the video from INPUT 1

So that you can use a single camera to produce a result similar to a two-camera setup.

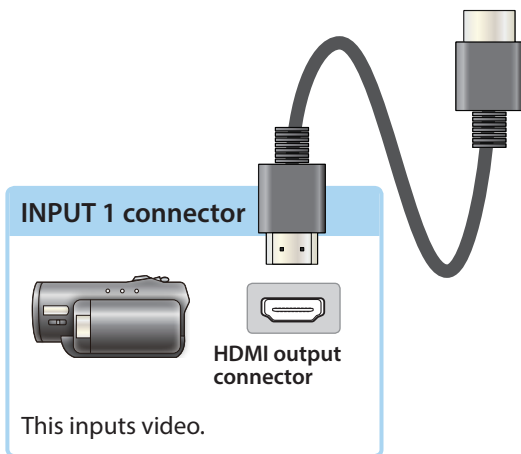
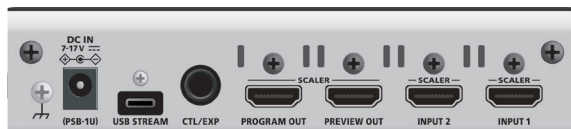

1. [MENU] button → “VIDEO INPUT” → select “INPUT 2,” and press the [VALUE] knob.
2. Use the [VALUE] knob to select “SHARED INPUT,” and press the [VALUE] knob.

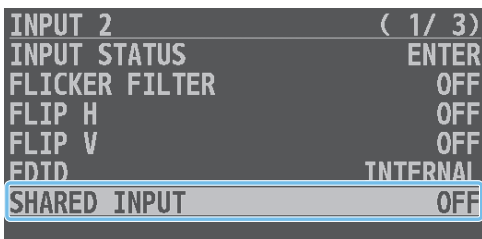

3. Use the [VALUE] knob to set it to “ON,” and press the [VALUE] knob.

Value	Explanation
ON	The video input of the INPUT 1 connector is input to INPUT 1 and INPUT 2. * The video input of the INPUT 2 connector is ignored.
OFF	The video input of the INPUT 1 connector is input to INPUT 1, and the video input of INPUT 2 is input to INPUT 2.

4. Press the [MENU] button several times to close the menu.

Inputting Copy-Protected (HDCP) Video

If you want to input HDCP-protected video from a BD player or other device, you can enable HDCP input.

- * If you want to output HDCP-protected video, connect an HDCP-capable display.

What's HDCP?

HDCP is copyright-protection technology that prevents unlawful copying of content by encoding the path when sending digital signals from a video playback device to a display monitor or other display equipment.

1. [MENU] button → “SYSTEM” → select “HDCP,” and press the [VALUE] knob.

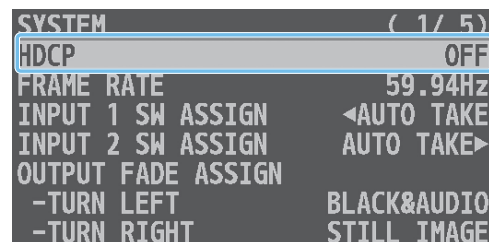

2. Use the [VALUE] knob to set it to “ON,” and press the [VALUE] knob.

Value	Explanation
ON	HDCP-protected video can be input. HDCP is applied to the output video.
OFF	HDCP-protected video cannot be input.

3. Press the [MENU] button several times to close the menu.

Video Operations



Using Mix/Wipe to Switch Video (MIX/WIPE)

Here's how to switch between input video while applying an effect, and output the program.

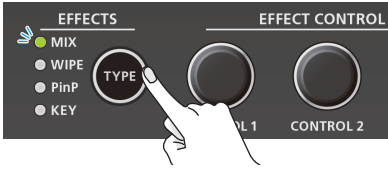
1. Press the [TYPE] button several times to select the transition effect (MIX, WIPE).



The MIX or WIPE indicator is lit.

Transition effects	Explanation
MIX	The two videos are mixed as the transition occurs. 
WIPE	The next video moves across to replace the original video. 

<Using the buttons to switch>

2. Press the button [1] or [2] that is lit green.

Lit red: Program output video
 Lit green: Preview output video (standby video)



The button you press blinks red, and the video switches.
 When the video has switched completely, the lit state (red, green) of buttons [1] [2] is exchanged.

MEMO

- **Functions of the [1] [2] buttons**
 You can assign auto take switching or other operations to the [1] and [2] buttons. Configure this in "INPUT 1 SW ASSIGN" and "INPUT 2 SW ASSIGN" in the SYSTEM menu.
 This setting is enabled only when mix/wipe is selected for the video effect.
- **Video transition time**
 If you use the buttons to switch video, the transition occurs over a pre-specified time. To specify the video transition time, set the TRANSITION menu item "MIX/WIPE TIME."

<Using the fader to switch>

2. Slide the video fader to the far left or far right.

The transition indicator for the video that is the program output is lit. Slide the fader toward the side that is not lit.



The video is switched according to the movement of the video fader.
 When the video has switched completely, the lit state (red, green) of buttons [1] [2] is exchanged.

MEMO

Depending on the timing at which you switch the video effect, the position of the video fader might differ from the actual output. If you operate the video fader in this state, the output does not change until the position of the video fader matches the actual output.

Changing the mix/wipe pattern

You can use the MIX/WIPE menu to specify the pattern by which the mix/wipe occurs and the direction of the wipe.

Menu item	Explanation
MIX TYPE	Transition pattern for mix
WIPE TYPE	Transition pattern for wipe
WIPE DIRECTION	Direction of wipe.
WIPE BORDER COLOR	Color of the border added to the edge of the wipe area
WIPE BORDER WIDTH	Width of the border added to the edge of the wipe area

Using Picture-In-Picture to Composite Video (PinP)

Here's how to composite an inset screen (a small separate screen) onto the background video.



1. Press the [TYPE] button several times to select PinP.

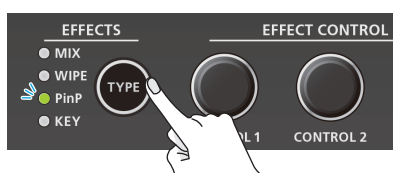

The PinP indicator is lit green, and the inset screen is shown in the preview output video (standby video).

You can check the position and size of the inset screen that will be composited before outputting the program.

2. Press the [1] button (lit yellow) to select the background video and the inset screen.

The transition indicator (left or right) of the selected background video is lit.

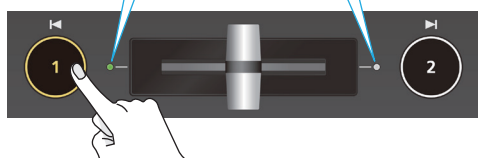

Each time you press the [1] button, the background video and the inset screen video that are output as the preview will alternate.

3. Use the [CONTROL 1] [CONTROL 2] knobs to adjust the inset screen.



[CONTROL 1] knob

Turn: Horizontal display position of the inset screen
Turn while pressing: Size of the inset screen (zoom)

[CONTROL 2] knob

Turn: Vertical display position of the inset screen
Turn while pressing: Zoom ratio of the inset screen

4. Press the [2] button.



The inset screen is composited with the background video, and output as the program. The [2] button is lit red.

When you press the [2] button once again, the [2] button goes dark and the inset screen disappears.

MEMO

- The fade time over which the inset screen appears or disappears when you press the [2] button is specified by the setting of the TRANSITION menu item "PinP TIME."
- You can also use the video fader to show or hide the inset screen.
- If a video composited by PinP is being output as the program, the PinP indicator is lit red.

Making detailed settings for the inset screen

You can use the PinP menu to specify the shape and size of the inset screen, and the color of the border that is added to the inset screen.

Menu item	Explanation
WINDOW	Use the following items to adjust the inset screen.
POSITION H	Horizontal display position
POSITION V	Vertical display position
SIZE	Size (zoom ratio)
CROPPING H	Horizontal frame size.
CROPPING V	Vertical frame size.
SHAPE	Shape (rectangle, circle, diamond)
BORDER COLOR	Color of the border.
BORDER WIDTH	Width of the border
VIEW	Use the following items to adjust the video that is shown in the inset screen.
POSITION H	Horizontal display position
POSITION V	Vertical display position
ZOOM	Zoom ratio

Using a Key to Composite Video (KEY)

Here's how you can turn a portion of the video transparent and composite it with the background video. You can use luminance key with either a black or a white background, or a chroma key with either a blue or green background.

Compositing a Logo or Image (Luminance Key)

You can cut out a logo or image by turning its black or white portion transparent, and then superimpose it on the background video.



Specifying the source and key type for the logo or image

Specify the source of the logo or image that you want to superimpose, and specify the key type used for compositing.

1. [MENU] button → "KEY" → select "KEY SOURCE" or "KEY TYPE."

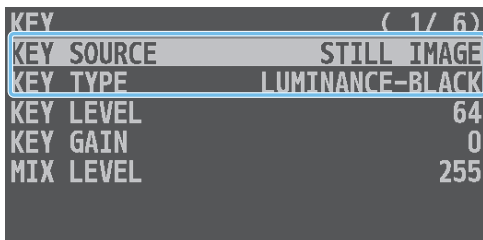

2. Use the [VALUE] knob to change the value, and press the [VALUE] knob.

●KEY SOURCE

Select the source of the logo or image that you want to superimpose.

Value	Explanation
INPUT 1, 2	The video of INPUT 1 or 2
STILL IMAGE	A captured still image (p. 20)

●KEY TYPE

Choose "LUMINANCE-WHITE" or "LUMINANCE-BLACK."

Value	Explanation
LUMINANCE-WHITE	Composite using luminance key. Makes white portions transparent according to brightness.
LUMINANCE-BLACK	Composite using luminance key. Makes black portions transparent according to brightness.
CHROMA	Composite using chroma key. Makes the specified key color transparent according to hue.

3. Press the [MENU] button several times to close the menu.

Compositing using luminance key

1. Press the [TYPE] button several times to select KEY.

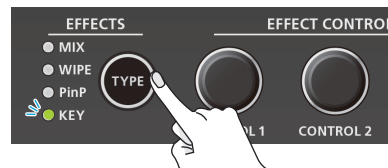

The KEY indicator is lit green, and the composition results is shown in the preview output video (standby video). You can check the key-composited logo or image before you output to program.

2. Press the [1] button to select the video of either INPUT 1 or 2 as the background.

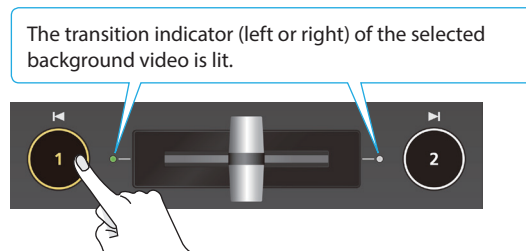

Each time you press the [1] button, the background video being output as the preview will switch.

3. Use the [CONTROL 1] [CONTROL 2] knobs to adjust the depth of the effect that is applied.



[CONTROL 1] knob

Adjusts the degree of extraction for the key.

[CONTROL 2] knob

Adjusts the degree of edge blur for the key.

4. Press the [2] button.



The composited result is output as the program. While it is output as the program, the [2] button and the KEY indicator are lit red. When you press the [2] button once again, the [2] button goes dark and the logo or image disappears.

MEMO

- The fade time over which the logo appears or disappears when you press the [2] button is specified by the setting of the TRANSITION menu item "KEY TIME."
- You can also use the video fader to show or hide the logo.
- The KEY indicator lights up red if a key composited video is being output as a program.

Modifying the logo or image

When using key compositing, you can fill-in the superimposed logo or image, or add an edge to it. Make these settings in the following KEY menu.

* These settings are shared with chroma key.

Menu item	Explanation
FILL TYPE	If this is set to "MATTE," the superimposed logo or image is filled-in with the specified color. The fill-in color is specified by "MATTE COLOR."
MATTE COLOR	
EDGE TYPE	Specifies the type of edge.
EDGE COLOR	Specifies the color of the edge.
EDGE WIDTH	Specifies the width of the edge.

Adjusting the logo or image position

When compositing the key, you can adjust the position and size as well as crop and zoom the superimposed logo or image, among other operations. These settings are in the KEY menu.

* These settings are shared with chroma key.

* This is valid when "KEY SOURCE" is set to "INPUT 1" or "INPUT 2."

Menu item	Explanation
WINDOW	Use the following parameters to adjust the superimposed screen.
POSITION H	Adjusts horizontal display position.
POSITION V	Adjusts vertical display position.
SIZE	Adjusts the size (zoom).
CROPPING H	Adjusts the horizontal frame size.
CROPPING V	Adjusts the vertical frame size.

Menu item	Explanation
VIEW	Use the following parameters to adjust the video that is shown in the superimposed screen.
POSITION H	Adjusts horizontal display position.
POSITION V	Adjusts vertical display position.
ZOOM	Adjusts the zoom.

Compositing a Subject and Background (Chroma Key)

You can cut out a video by turning its blue or green portion transparent, and then superimpose it on the background video. This lets you composite a subject that's photographed against a blue background or green background.

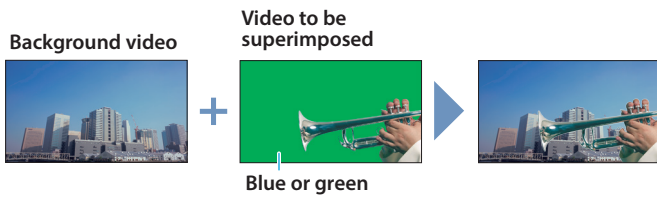

Specifying the source and key type for the video

Specify the source and key type for the video that you want to superimpose.

1. [MENU] button → "KEY" → select "KEY SOURCE," "KEY TYPE," or "COLOR," and press the [VALUE] knob.

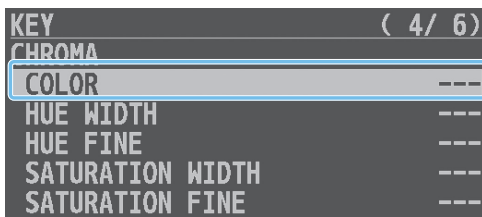
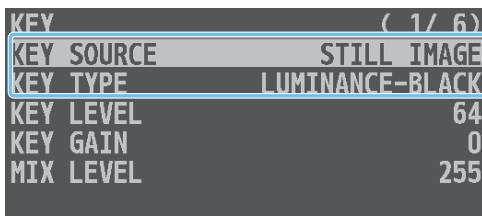

2. Use the [VALUE] knob to change the value, and press the [VALUE] knob.

●KEY SOURCE

Select the source of the video that you want to superimpose.

Value	Explanation
INPUT 1, 2	The video of INPUT 1 or 2
STILL IMAGE	A captured still image (p. 20)

●KEY TYPE

Set to "CHROMA."

Value	Explanation
LUMINANCE-WHITE	Composite using luminance key. Makes white portions transparent according to brightness.
LUMINANCE-BLACK	Composite using luminance key. Makes black portions transparent according to brightness.
CHROMA	Composite using chroma key. Makes the specified key color transparent according to hue.

●COLOR

Specify either "GREEN" or "BLUE" as the key color for chroma key (the color to be removed).

3. Press the [MENU] button several times to close the menu.

Compositing using chroma key

1. Press the [TYPE] button several times to select KEY.

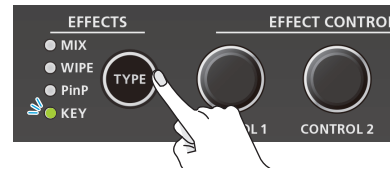

The KEY indicator is lit green, and the composition results is shown in the preview output video (standby video). You can check the key-composited video before you output to program.

2. Press the [1] button to select the video of either INPUT 1 or 2 as the background.

The transition indicator (left or right) of the selected background video is lit.

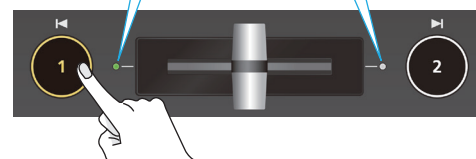

Each time you press the [1] button, the background video being output as the preview will switch.

3. Use the [CONTROL 1] [CONTROL 2] knobs to adjust the depth of the effect that is applied.



[CONTROL 1] knob

Adjusts the degree of extraction for the key.

[CONTROL 2] knob

Adjusts the degree of edge blur for the key.

4. Press the [2] button.



The composited result is output as the program. While it is output as the program, the [2] button and the KEY indicator are lit red. When you press the [2] button once again, the [2] button goes dark and the superimposed video disappears.

MEMO

- The fade time with which the video superimposed by the [2] button appears or disappears is specified by the TRANSITION menu item "KEY TIME."
- You can also reveal or hide the superimposed video by operating the video fader.
- The KEY indicator lights up red if a key composited video is being output as a program.

Finely adjusting the key color (removed color)

You can use the following KEY menu to make fine adjustments to the key color (the color that is removed).

Menu item	Explanation
CHROMA	Use the following items to make fine adjustments to the key color.
HUE WIDTH	Adjusts the hue width.
HUE FINE	Adjusts the center position of the hue.
SATURATION WIDTH	Adjusts the saturation width.
SATURATION FINE	This adjusts the center position of saturation.

Modifying the superimposed video

When using key compositing, you can fill-in the superimposed video, or add an edge to it. Make these settings in the following KEY menu.

- * These settings are shared with luminance key.

Menu item	Explanation
FILL TYPE	If this is set to "MATTE," the superimposed video is filled-in with the specified color.
MATTE COLOR	The fill-in color is specified by "MATTE COLOR."
EDGE TYPE	Specifies the type of edge.
EDGE COLOR	Specifies the color of the edge.
EDGE WIDTH	Specifies the width of the edge.

Adjusting the video position

When compositing the key, you can adjust the position and size as well as crop and zoom the superimposed video, among other operations. These settings are in the KEY menu.

- * These settings are shared with luminance key.
- * This is valid when "KEY SOURCE" is set to "INPUT 1" or "INPUT 2."

Menu item	Explanation
WINDOW	Use the following parameters to adjust the superimposed screen.
POSITION H	Adjusts horizontal display position.
POSITION V	Adjusts vertical display position.
SIZE	Adjusts the size (zoom).
CROPPING H	Adjusts the horizontal frame size.
CROPPING V	Adjusts the vertical frame size.

Menu item	Explanation
VIEW	Use the following parameters to adjust the video that is shown in the superimposed screen.
POSITION H	Adjusts horizontal display position.
POSITION V	Adjusts vertical display position.
ZOOM	Adjusts the zoom.

To specify a desired color as the key color (sampling marker)

You can specify the key color to be made transparent simply by sampling (detecting) a color from the video. (This is called the sampling marker function.) You can also specify a key color other than green or blue.

To use the sampling marker function, set the KEY menu item "KEY TYPE" to "CHROMA," and use the [TYPE] button to select "KEY."

1. [MENU] button → "KEY" → select "SAMPLING MARKER," and press the [VALUE] knob.

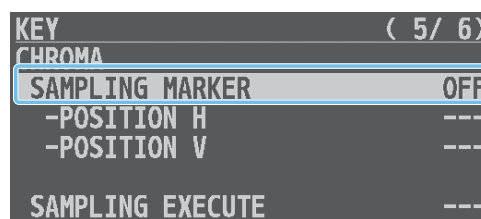

2. Use the [VALUE] knob to set it to "ON," and press the [VALUE] knob.

The sampling marker () for sampling (detecting) the key color appears in the preview output video.

3. Use the [CONTROL 1] [CONTROL 2] knobs to adjust the position of the sampling marker.

[CONTROL 1] knob

Adjusts the horizontal position.

[CONTROL 2] knob

Adjusts the vertical position.

4. Use the [VALUE] knob to select "SAMPLING EXECUTE."

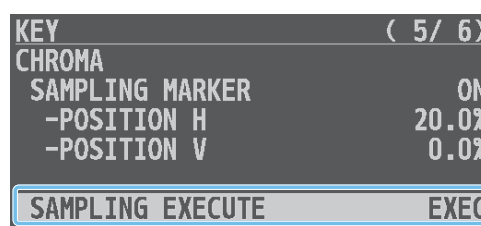

A recognition message appears.

If you want to cancel the operation, press the [MENU] button.

5. Use the [VALUE] knob to select "YES," and press the [VALUE] knob.

The key color is sampled.

The "HUE WIDTH," "HUE FINE," "SATURATION WIDTH," and "SATURATION FINE" settings are adjusted automatically.

6. Press the [MENU] button several times to close the menu.

Applying a Visual Effect to the Video (VFX)

Here's how you can apply an effect to the entire video, such as varying the video's color or shape. You can apply a visual effect even while using picture-in-picture (p. 13) or key (p. 14, 16) to composite the video.

Selecting a visual effect

1. [MENU] button → "VFX" → select "VFX TYPE," and press the [VALUE] knob.

VFX	(1 / 1)
VFX	ON
VFX TYPE	COLOR PASS
CONTROL 1 TYPE	42
CONTROL 2 N/A	---
MIX LEVEL	255

2. Use the [VALUE] knob to select the visual effect, and press the [VALUE] knob.

Value	Explanation
PART MOSAIC	Applies a mosaic to the selected region.
BACKGROUND MOSAIC	Applies a mosaic to the portion outside the selected region.
FULL MOSAIC	Applies a mosaic to the entire screen.
WAVE	Makes the video wavy.
RGB REPLACE	Exchanges the colors.
COLORPASS	Turns the video black and white while preserving a specific color.
NEGATIVE	Inverts the brightness and colors.
COLORIZE	Adds color to the video.
POSTERIZE	Changes the gradations in brightness.
SILHOUETTE	Separates the video into light and dark areas, and makes the dark areas black and adds a different color to the light areas.
EMBOSS	Adds a bas-relief effect to the video.
FIND EDGES	Extracts contours.
MONOCOLOR	Turns the video monochrome.
HUE OFFSET	Changes the visual character by controlling the hue.
SATURATION OFFSET	Changes the visual character by controlling the saturation.
VALUE OFFSET	Changes the visual character by controlling the brightness.

3. Press the [MENU] button several times to close the menu.

Applying visual effects

1. Send the video on which you want to apply an effect to the program output.
2. Press the [VFX] button to turn on the visual effect (making the button light up).



The visual effect is applied to the program output video.

3. Use the [CONTROL 1] or [CONTROL 2] knob to adjust the degree of effect applied.

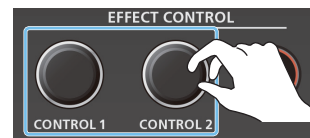

MEMO

- For "PART MOSAIC" and "BACKGROUND MOSAIC," you can adjust the following settings by turning the [CONTROL 1] or [CONTROL 2] knobs while pressing them.
 - [CONTROL 1] knob
Size of the selected region
 - [CONTROL 2] knob
Mosaic detail (block size)
- Settings for the effect that is controlled by the [CONTROL 1] [CONTROL 2] knobs can be checked in the VFX menu.

4. To turn off a visual effect, press the [VFX] button once again.

Applying a Fade to the Program Output Video (Output Fade)

Here's how to perform a fade-out from the program output video to a black screen, or a fade-in from a black screen to the program output video.

You can insert a black screen into the program output video at times where you don't want to output a picture, such as at intervals in presentations or band performances.

* The fade-in/out effect is applied only to the program output.

Applying a Fade-out

1. Turn the [OUTPUT FADE] knob fully counterclockwise.



The program output video fades to a black screen.

When fade is applied, the [OUTPUT FADE] knob indicator blinks red. When the fade-out is complete, the indicator is lit red.

Applying a Fade-in

1. Return the [OUTPUT FADE] knob to the center.

The [OUTPUT FADE] knob indicator goes dark, and program output begins.

MEMO

By changing the function that's assigned to the [OUTPUT FADE] knob, you can fade-in/out using a white screen. Make these settings in the SYSTEM menu items OUTPUT FADE ASSIGN "TURN LEFT" and "TURN RIGHT."

Using a Captured Still Image

A still image captured from the input video can be output in the same way as the video. You can also use it as a source for key compositing (p. 14, 16).

Specifying how the still image is saved

The captured still image can be saved in either of two ways: saved in the unit or temporarily saved in the unit (and deleted when the power turns off). The captured resolution differs depending on the method of saving.

The method of saving the still image is specified by the CAPTURE IMAGE menu settings "SAVE TO INTERNAL STORAGE." Choose the save method as appropriate for the still image that you want to use.

Value	Explanation
DISABLE	The still image is captured at the actual resolution and temporarily saved in the unit. When you turn off the power, the captured still image is deleted. This allows the image to be captured without impairing the image quality. It is suitable for still images that include a logo or small characters.
ENABLE	The still image is captured at a reduced resolution of 640 x 360 and saved in the unit. Since the still image is expanded when it is output, the image quality might be impaired.

MEMO

- The unit can only save one still image (including temporary saving). If a still image is already saved, it is overwritten when you execute a new capture.
- If the still image output function is assigned to the [OUTPUT FADE] knob, the [OUTPUT FADE] knob indicator shows whether a still image exists.



Lit green/red	Unit contains still image When lit red, the still image is being output
Dark	Unit contains no still image

The function of the [OUTPUT FADE] knob is specified by the SYSTEM menu settings OUTPUT FADE ASSIGN "TURN LEFT" and "TURN RIGHT."

- Regarding copy-protected (HDCP) video**
If you capture a still image from copy-protected (HDCP) video, the resulting still image is treated in the same way as HDCP video. The still image is shown or not shown depending on whether HDCP is on or off (p. 11).

Capturing a still image

Here's how to capture a still image from the input video.

NOTE

- If the CAPTURE IMAGE menu item "SAVE TO INTERNAL STORAGE" is set to "ENABLE" (save still image to unit), it will take approximately 30 seconds for capture to be completed.
- Input stops for the video being captured.

< To capture by operating a button >

NOTE

You can't capture images unless you set "SHORTCUT(INPUT SW)" in the CAPTURE IMAGE menu to "ENABLE" (this is "DISABLE" by default).

- Press the [TYPE] button several times to select the transition effect (MIX, WIPE).

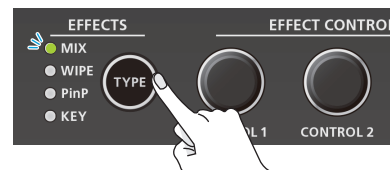

- * You can capture by operating a button only if mix or wipe is selected as the video effect.

- According to the still image that you want to capture, long-press the [1] or [2] button (three seconds or longer).

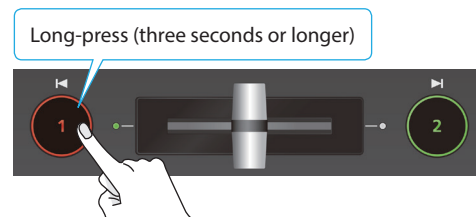

The capture is executed. Input stops for the video that is being captured. When the normal output returns, capture is complete.

MEMO

If you've made settings in the SYSTEM menu to assign the operation of the [1][2] buttons as follows, you can't capture by operating a button.

- INPUT 1 SW ASSIGN: ◀ TRANSFORM
- INPUT 2 SW ASSIGN: TRANSFORM ▶

< To capture by operating the menu >

1. [MENU] button → “CAPTURE IMAGE” → select “CAPTURE SOURCE,” and press the [VALUE] knob.



2. Use the [VALUE] knob to select either “INPUT 1” or “INPUT 2” according to the still image that you want to capture, and press the [VALUE] knob.

3. Use the [VALUE] knob to select “CAPTURE EXECUTE.”

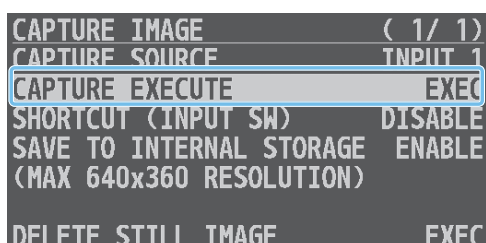

A recognition message appears.

If you want to cancel the operation, press the [MENU] button.

4. Use the [VALUE] knob to select “YES,” and press the [VALUE] knob.

The capture is executed. Input stops for the video that is being captured.

When capture is complete, the message “COMPLETE” appears, and normal output returns.

5. Press the [MENU] button to close the message.
6. Press the [MENU] button several times to close the menu.

Outputting a Still Image

1. Turn the [OUTPUT FADE] knob fully clockwise.

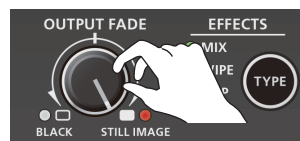

The [OUTPUT FADE] knob indicator is lit red, and the still image is output from preview/program.

- * When outputting the still image, the transition occurs by a cut regardless of the transition effect that is selected.

2. To return to normal video output, return the [OUTPUT FADE] knob to the center.

MEMO

You can also assign other functions to the [OUTPUT FADE] knob. Make settings for the SYSTEM menu items OUTPUT FADE ASSIGN “TURN LEFT” or “TURN RIGHT.”

Deleting a Still Image

Here's how to delete the still image that's saved in the unit.

1. [MENU] button → “CAPTURE IMAGE” → select “DELETE STILL IMAGE.”

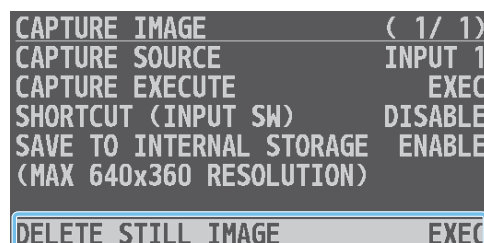

A recognition message appears.

If you want to cancel the operation, press the [MENU] button.

2. Use the [VALUE] knob to select “YES,” and press the [VALUE] knob.

The still image is deleted. When the operation is finished, the message “COMPLETE” appears.

3. Press the [MENU] button to close the message.
4. Press the [MENU] button several times to close the menu.

Audio Operations

Adjusting the Input Gain (Sensitivity)

Adjust the input gain of AUDIO IN 1 and AUDIO IN 2 so that the input audio is at an appropriate level.

1. [MENU] button → “AUDIO INPUT” → select “AUDIO IN 1” or “AUDIO IN 2,” and press the [VALUE] knob.

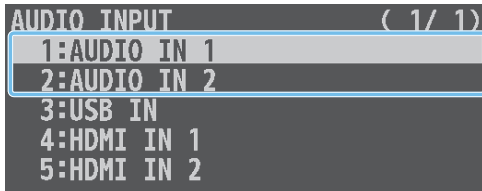

2. Use the [VALUE] knob to select “INPUT LEVEL,” and press the [VALUE] knob.
3. Use the [VALUE] knob to select “0.0dB,” and press the [VALUE] knob.

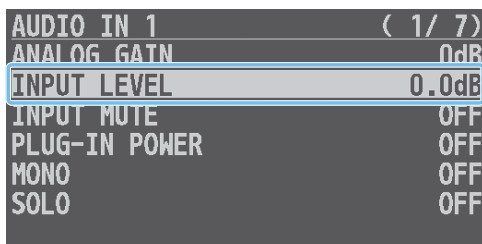

4. Use the [VALUE] knob to select “ANALOG GAIN,” and press the [VALUE] knob.

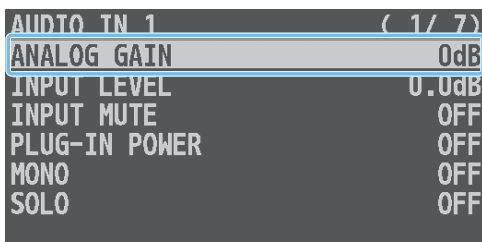

5. Turn the [VALUE] knob fully counter-clockwise, minimizing (0 dB) the input gain.
6. While producing the sound that will actually be input, slowly turn the [VALUE] knob clockwise to adjust the input gain.
Raise the input gain as high as possible without allowing the level meter to light red when the loudest sound level occurs.

* The level meter is displayed in the multi-view.

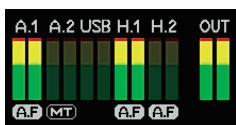

7. Press the [MENU] button several times to close the menu.

Adjusting the Volume Level

Here's how to adjust the volume of the audio input and audio output.

1. [MENU] button → "AUDIO INPUT" → select "AUDIO IN 1"–"HDMI IN 2," and press the [VALUE] knob.

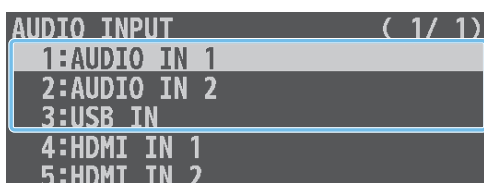

2. Use the [VALUE] knob to select "INPUT LEVEL," and press the [VALUE] knob.

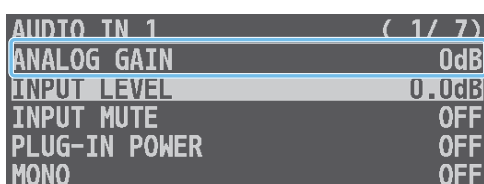

3. Use the [VALUE] knob to adjust the input volume, and press the [VALUE] knob.

Raise the volume level of audio you want to make more prominent, for example, an emcee microphone, and lower the volume level for other audio.

When no audio is input, and for audio that is unused, lower the volume level to minimum (-INF).

4. Press the [MENU] button twice to return to the MENU screen.

5. Use the [VALUE] knob to select "AUDIO OUTPUT" → "MASTER OUTPUT," and press the [VALUE] knob.

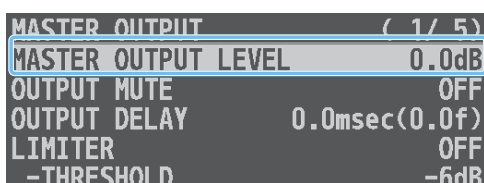

6. Use the [VALUE] knob to select "MASTER OUTPUT LEVEL," and press the [VALUE] knob.

7. Use the [VALUE] knob to adjust the output volume.

8. Press the [MENU] button several times to close the menu.

Level meter indication

An audio level meter is shown at the lower right of the preview display. The level meter illumination lets you check whether the volume is adjusted appropriately.

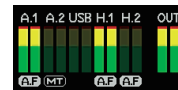

Indicator	Status
Red	Lights up at 0 dB or higher. It indicates an excessive volume level.
Yellow	Lights up at -20 to -1 dB. It indicates an appropriate volume level.
Green	Lights up at -50 to -21 dB. It indicates a too-low volume level.

- * If the volume level of speaker output is unsuitable even when the volume level on the V-02HD MK II has been adjusted so that level meter light up in yellow, adjust the volume for the speakers and amplifiers. Using "OUTPUT LEVEL" to make adjustments can sometimes result in distortion or poorer sound quality.

MEMO

- If you use the [OUTPUT FADE] knob to fade-in/out the program output video (p. 19), the output audio also fades-in/out simultaneously.
- You can change the function that's assigned to the [OUTPUT FADE] knob so that it adjusts only the output volume. Set the SYSTEM menu item OUTPUT FADE ASSIGN "TURN LEFT" or "TURN RIGHT" to "AUDIO."
- You can output a test tone that's convenient when adjusting the volume. In the SYSTEM menu item "TEST TONE," specify the test tone that will be output.
- You can adjust the respective volumes of AUDIO IN 1 and AUDIO IN 2 without entering the menu, by turning the [CONTROL 1] and [CONTROL 2] knobs while holding down the [VFX] button.
- From the menu, you can change the parameters that are adjustable using the [CONTROL 1] and [CONTROL 2] knobs.

Adjusting the AUX bus output volume

1. [MENU] button → "AUDIO OUTPUT" → "AUX" → select "AUX LEVEL," and press the [VALUE] knob.

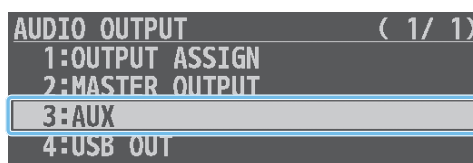

2. Use the [VALUE] knob to adjust the output volume, and press the [VALUE] knob.

3. Press the [MENU] button several times to close the menu.

Applying Effects to Input Audio

You can apply effects to the input audio to adjust the character of the sound. The following table shows the effects that are available.

Input audio	High-pass filter	Noise gate	De-esser	Compressor	Equalizer	Voice changer	Delay	Reverb
AUDIO IN 1, 2	✓	✓	✓	✓	✓	✓	✓	✓
USB IN, HDMI IN 1, 2	—	✓	—	✓	✓	—	✓	✓

1. [MENU] button → “AUDIO INPUT” → select “AUDIO IN 1”–“HDMI IN 2,” and press the [VALUE] knob.

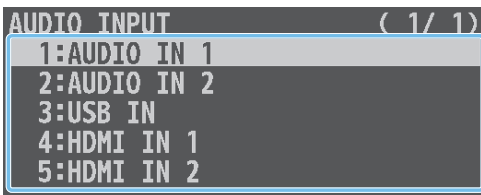

2. Using the [VALUE] knob, select the menu item of the effect you want to use, and press the [VALUE] knob.
3. Use the [VALUE] knob to change the value of the setting, and press the [VALUE] knob.
4. Press the [MENU] button several times to close the menu.

● High-pass filter

Cuts off unneeded low-band audio. The cutoff frequency is 80 Hz.

● Noise gate

Eliminates audio that is lower than the specified threshold level. This is effective when the noise that you want to remove is separate from the audio that you want to keep, and can be used to remove hiss or other noise that is heard during periods of silence.

● De-esser

Reduces sibilant noise (the sounds you hear when pronouncing “s” words and other hissing sounds).

● Compressor

Audio that exceeds the specified threshold level is compressed. This reduces the difference between the maximum volume and minimum volume, making the audio more comfortable for listening.

● Equalizer

This is a three-band equalizer. It lets you adjust the volume by boosting or cutting three frequency regions.

● Voice changer (p. 25)

Modify the pitch or character of the voice.

● Delay (p. 25)

This outputs audio with a delay.

● Reverb (p. 26)

Adds reverberation to the sound.

Using an effect preset

The V-02HD MK II provides effect presets that are appropriate for specific environments. Simply by selecting a preset you can easily apply the appropriate effect for your purpose.

Each preset consists of a combination of three effects (high-pass filter, compressor, equalizer).

MEMO

- If you want to make fine adjustments to a preset, use the AUDIO INPUT menu to edit the high-pass filter, compressor, and equalizer settings.
- You can't overwrite the effect presets. Use the preset memories to save the settings for presets you've edited (p. 31).
- When you load an effect preset, each effect setting is restored to its preset default setting (factory settings).

1. [MENU] button → “AUDIO INPUT” → select “AUDIO IN 1”–“HDMI IN 2,” and press the [VALUE] knob.

2. Use the [VALUE] knob to select “EFFECT PRESET,” and press the [VALUE] knob.



3. Use the [VALUE] knob to select an effect preset, and press the [VALUE] knob.

Value	Explanation
DEFAULT	For line input (default setting)
MEETING	For meetings
INTERVIEW	For interviews
AMBIENT MIC	For capturing ambient sound
WINDY FIELD	For capturing ambient sound in a windy area

A recognition message appears.

If you want to cancel the operation, press the [MENU] button.

4. Use the [VALUE] knob to select “OK,” and press the [VALUE] knob.

The preset is loaded. When the operation is finished, the message “COMPLETE” appears.

5. Press the [MENU] button several times to close the menu.

Changing the Character of a Voice (Voice Changer)

Here's how to modify the pitch or character of the voice that's input from a mic. You can create transformations such as "from a female to a male voice," "from a male to a female voice," or "robot voice."

* This only works on the input audio from the AUDIO IN 1, 2 jacks.

1. [MENU] button → "AUDIO INPUT" → "AUDIO IN 1" or "AUDIO IN 2" → select "VOICE CHANGER," and press the [VALUE] knob.

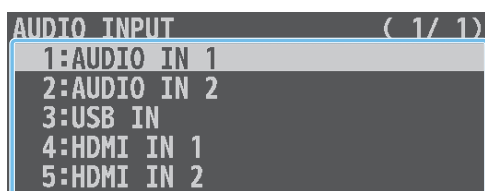

2. Use the [VALUE] knob to select "ON," and press the [VALUE] knob.

Voice changer turns on.

3. Use the [VALUE] knob to select a menu item and press the [VALUE] knob.

Menu item	Explanation
PITCH	Adjusts the pitch of the voice in semitone steps. A setting of "0" is the original pitch.
FORMANT	Adjusts the character (formant) of the voice. Settings in the negative (-) direction produce a more masculine vocal character, and settings in the positive (+) direction produce a more feminine vocal character. A setting of "0" is the original voice.
ROBOT	If this is "ON," the voice is held at a fixed pitch, creating a mechanical robot-like impression.
MIX	Adjusts the balance between the unprocessed voice (0) and the voice processed by the effect (100).

4. Use the [VALUE] knob to change the value of the setting, and press the [VALUE] knob.
5. Press the [MENU] button several times to close the menu.

Correcting a time difference between video and audio (delay)

Here's how you can correct a time difference between the video and audio by delaying the output of the input audio.

1. [MENU] button → "AUDIO INPUT" → select "AUDIO IN 1" – "HDMI IN 2," and press the [VALUE] knob.

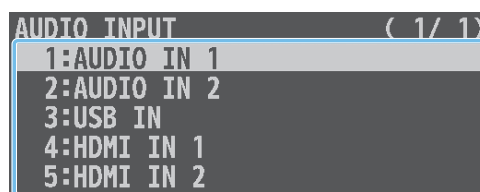

2. Use the [VALUE] knob to adjust the time by which the audio is delayed, and press the [VALUE] knob.
3. Press the [MENU] button several times to close the menu.

Applying Reverb

This adds reverberation to the sound.

* Reverb is not applied to the audio from the AUX bus.

Adjusting how much reverb to send

1. [MENU] button → “AUDIO INPUT” → select “AUDIO IN 1” – “HDMI IN 2,” and press the [VALUE] knob.
2. Use the [VALUE] knob to select “REVERB SEND,” and press the [VALUE] knob.



3. Use the [VALUE] knob to adjust the amount of sound that is sent to reverb (reverb depth), and press the [VALUE] knob.
4. Press the [MENU] button several times to close the menu.

Adjusting how much reverb is returned

1. [MENU] button → “AUDIO OUTPUT” → “MASTER OUTPUT” → select “REVERB,” and press the [VALUE] knob.

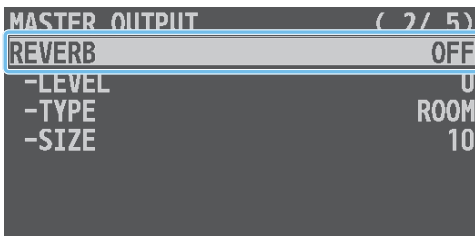

2. Use the [VALUE] knob to select “ON,” and press the [VALUE] knob.
Reverb turns on.
3. Using the [VALUE] knob, select the item , and press the [VALUE] knob.

Menu item	Explanation
LEVEL	Specifies the amount of sound that is returned from the reverb (return level). This adjusts the depth of the overall reverb.
TYPE	Specifies the reverb type. ROOM: Produces the natural-sounding reverberation of a room. HALL: Produces the reverberation that is typical of a performance in a concert hall.
SIZE	Specifies the size of the room. The larger the value, the longer the reverb time.

4. Use the [VALUE] knob to change the value of the setting, and press the [VALUE] knob.
5. Press the [MENU] button several times to close the menu.

Applying Effects to Output Audio

You can modify the tonal character by applying effects to the audio output. The following table shows the effects that are available.

Audio bus	Reverb	Equalizer	Delay	Multi band compressor	Limiter
MASTER OUTPUT	✓	✓	✓	✓	✓
AUX	—	—	✓	—	✓

1. [MENU] button → “AUDIO OUTPUT” → select “MASTER OUTPUT,” “AUX” or “USB OUT,” and press the [VALUE] knob.

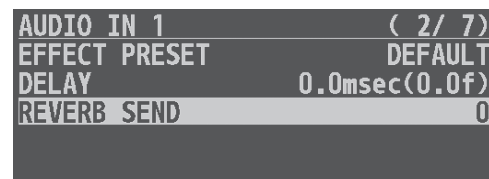

2. Using the [VALUE] knob, select the menu item of the effect you want to use, and press the [VALUE] knob.
3. Use the [VALUE] knob to change the value of the setting, and press the [VALUE] knob.
4. Press the [MENU] button several times to close the menu.

- **Reverb**
Adds reverberation to the sound.
- **Equalizer**
This is a three-band equalizer. It lets you adjust the volume by boosting or cutting three frequency regions.
- **Delay**
Delays the audio output. Delaying the output lets you correct timing problems in the audio signal that is input to the output destination device.
- **Compressor**
This applies separate compressors in individual frequency bands.
- **Limiter**
Limits the output volume so that it does not exceed the specified threshold level.
* Distortion will occur if audio that exceeds the allowable range of the limiter is input.

MEMO

Adjusting the equalizer/delay for the USB output audio

For USB output, you can also apply equalizer and delay effects to fine-tune the sound assigned to the bus.

Adjust the equalizer and delay parameters from the [MENU] button → “AUDIO OUTPUT” → “USB OUT.”

Silencing Only Specific Audio (Mute)

Here's how to temporarily silence specific input audio or output audio (the mute function).

Muting input audio

1. [MENU] button → "AUDIO INPUT" → select "AUDIO IN 1"–"HDMI IN 2," and press the [VALUE] knob.

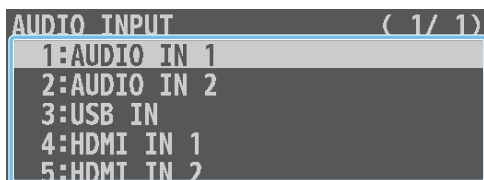

2. Use the [VALUE] knob to select "INPUT MUTE," and press the [VALUE] knob.

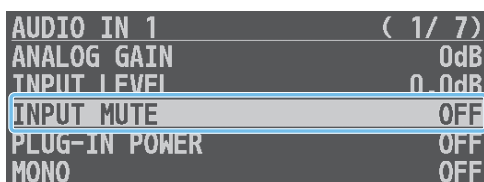

3. Use the [VALUE] knob to set it to "ON," and press the [VALUE] knob.

To cancel muting, specify "OFF."

4. Press the [MENU] button several times to close the menu.

Muting output audio

1. [MENU] button → "AUDIO OUTPUT" → select "MASTER OUTPUT," "AUX" or "USB OUT."

2. Use the [VALUE] knob to select "MUTE" for each output audio signal, and press the [VALUE] knob.

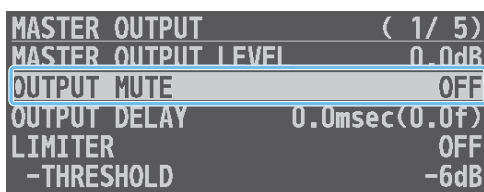

3. Use the [VALUE] knob to set it to "ON," and press the [VALUE] knob.

To cancel muting, specify "OFF."

4. Press the [MENU] button several times to close the menu.

MEMO

The level meter shown at the lower right of the preview display indicates the mute setting.

The "MT" symbol is shown to indicate audio for which muting is on.

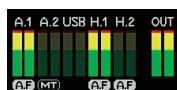

Checking a Specific Audio Input (Solo)

Here's how you can temporarily monitor a specific audio input via the headphones (solo function).

* The solo function applies to the headphone output. It does not affect output other than the headphones.

1. [MENU] button → "AUDIO INPUT" → select "AUDIO IN 1"–"HDMI IN 2," and press the [VALUE] knob.

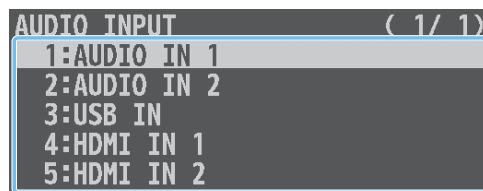

2. Use the [VALUE] knob to select "SOLO," and press the [VALUE] knob.

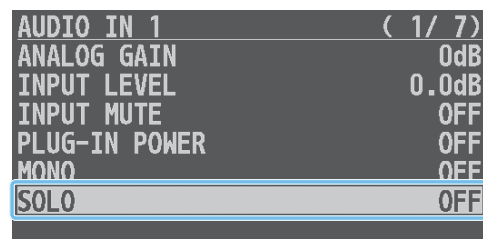

3. Use the [VALUE] knob to select "ON," and press the [VALUE] knob.

4. Press the [MENU] button several times to close the menu.

Interlinking Audio Output to Video Switching (Audio Follow)

Here's how the audio output can be automatically switched in tandem with video switching (the audio follow function). When you switch video, only the audio of the currently selected input video is output, and the audio of the other input video is automatically muted.

1. As described in "Adjusting the Input Gain (Sensitivity)" (p. 22), adjust the output volume as desired.

2. [MENU] button → "AUDIO FOLLOW" → select "HDMI IN 1" or "HDMI IN 2," and press the [VALUE] knob.

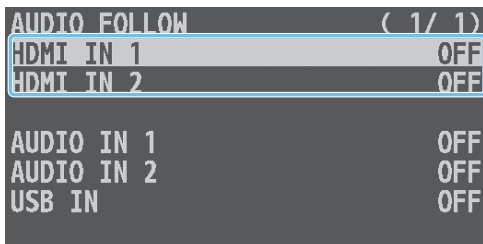

3. Use the [VALUE] knob to select "ON," and press the [VALUE] knob.

Value	Explanation
ON	Enables the Audio Follow feature. The audio of only the selected input video is output, and the audio of the other input video is automatically muted.
OFF	Disables the Audio Follow feature.

4. Press the [MENU] button several times to close the menu.

MEMO

The level meter shown at the lower right of the preview display indicates the audio follow setting.

The "A.F" symbol is shown to indicate audio for which audio follow is on.

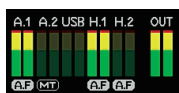

Applying audio follow to the audio from AUDIO IN

1. [MENU] button → "AUDIO FOLLOW" → select "AUDIO IN 1," "AUDIO IN 2" or "USB IN," and press the [VALUE] knob.

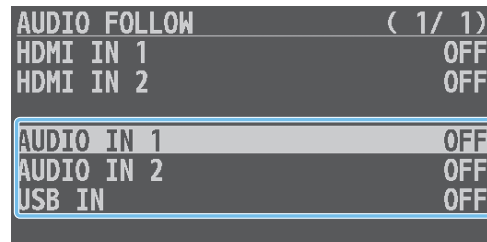

2. Use the [VALUE] knob to set the input video that uses audio follow, and press the [VALUE] knob.

Value	Explanation
INPUT 1, INPUT 2, STILL IMAGE	For the selected input audio (AUDIO IN 1, 2 or USB IN), specify the input video (INPUT 1, 2 or STILL IMAGE) that uses audio follow. The audio in question is output only when the specified input video is selected. For instance, when INPUT 2 is specified as the audio follow for AUDIO IN 1, the audio from AUDIO IN 1 is only outputted when the input video of INPUT 2 is selected.
OFF	The audio of AUDIO IN is always output regardless of the input video that's selected.

3. Press the [MENU] button several times to close the menu.

Outputting AUX Bus Audio

The V-02HD MK II has two buses: the “MASTER OUTPUT bus” and the “AUX bus.” You can assign a desired bus to each output connector.

MASTER OUTPUT	This mixes and outputs all input audio (master output).
AUX	This mixes and outputs only the input audio that is sent to the AUX bus. This allows you to output audio that is different than the master output. For example, in a live event, you might output a mix of all audio inputs, while separately outputting a mix of only specific audio inputs (the AUX bus) for recording or streaming.

Assigning the AUX Bus

PHONES jack, USB STREAM port

1. [MENU] button → “AUDIO OUTPUT” → “OUTPUT ASSIGN” → select the output jack, and press the [VALUE] knob.

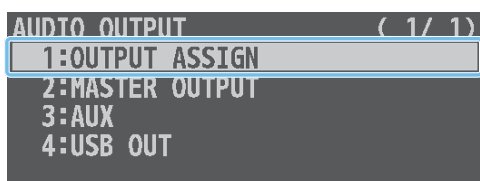

2. Use the [VALUE] knob to select “AUX,” and press the [VALUE] knob.

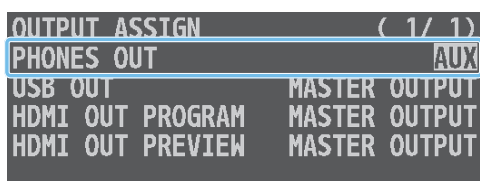

Value	Explanation
MASTER OUTPUT	Output the audio of the MASTER OUTPUT bus.
AUX	Output the audio of the AUX bus.

3. Press the [MENU] button several times to close the menu.

HDMI OUT PROGRAM, PREVIEW connector

1. [MENU] button → “AUDIO OUTPUT” → “OUTPUT ASSIGN” → select the output jack, and press the [VALUE] knob.
2. Use the [VALUE] knob to select “AUX,” and press the [VALUE] knob.

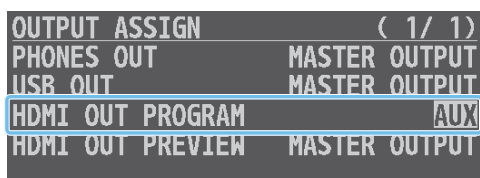

Value	Explanation
MASTER OUTPUT	Output the audio of the MASTER OUTPUT bus.
AUX	Output the audio of the AUX bus.

3. Press the [MENU] button several times to close the menu.

Sending Audio to the AUX Bus

You can send the input audio of the AUDIO IN 1–HDMI IN 2 jacks to the AUX bus.

1. [MENU] button → “AUDIO OUTPUT” → select “AUX,” and press the [VALUE] knob.

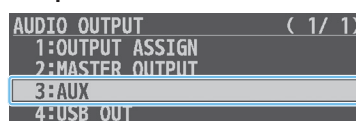

2. Using the [VALUE] knob, select the menu item of the “AUX SEND,” and press the [VALUE] knob.



3. Use the [VALUE] knob to select input audio, and press the [VALUE] knob.
4. Use the [VALUE] knob to adjust the amount that is sent to the AUX bus, and press the [VALUE] knob.
5. Press the [MENU] button several times to close the menu.

Adjusting the audio of the AUX bus

You can select whether to send either the original audio or the audio processed with effects to the AUX bus.

1. [MENU] button → “AUDIO OUTPUT” → “AUX” → select “AUX EFFECT,” and press the [VALUE] knob.
The AUX EFFECT menu screen appears.
2. Use the [VALUE] knob to select input audio, and press the [VALUE] knob.
3. Use the [VALUE] knob to select “DRY,” “PRE FADER” or “POST FADER,” and press the [VALUE] knob.

Value	Explanation
DRY	Sends the source audio with no effects applied.
PRE FADER	Sends the effect-applied audio. The send volume is constant, regardless of the volume (INPUT LEVEL).
POST FADER	Sends the effect-applied audio. The send volume can be changed by adjusting the volume (INPUT LEVEL).

4. Use the [VALUE] knob to adjust the amount that is sent, and press the [VALUE] knob.
5. Press the [MENU] button several times to close the menu.

Live Streaming

Outputting Video/Audio to a Computer for Streaming

Here's how the video and audio mixed by the V-02HD MK II can be output to a connected computer. You can also input audio that's played back by the computer.

By using an internet-connected computer with streaming app, you can distribute content as a live internet stream.

In order for the audio and video from the V-02HD MK II to be correctly viewed on the computer, app that supports the USB video class and USB audio class must be installed on the computer.

For the latest operating requirements, refer to the Roland website (<https://proav.roland.com/>).

Outputting video and audio to the computer

1. Using a USB 3.0 cable, connect a USB 3.0 port on the computer to the USB STREAM port on the V-02HD MK II.

2. Turn on the power to the V-02HD MK II.

3. Start the computer.

* When communication with the computer has been established, the computer recognizes the V-02HD MK II as a USB video device and USB audio device.

The first time that the V-02HD MK II is connected to the computer, the standard drivers of the operating system are installed automatically.

4. Operate the V-02HD MK II to prepare the video and audio that you want to output to the computer.

5. On your computer, verify the input from the V-02HD MK II.

Start app that supports the USB video class and audio class, and verify the video and audio that are being input from the V-02HD MK II.

MEMO

What to do when operations are unstable, such as when the video distorts

Press the [MENU] button to select "VIDEO OUTPUT" → "USB OUT" and execute "CONNECTION RESET," and then try reconnecting your computer to the V-02HD MK II.

Video formats

You can change the USB output video format and compression method from the livestreaming app or other app used at the output destination. The following video formats are supported.

USB OUT frame rate	video format		
60Hz	1080/60p	720/60p	640x480/60p
59.94Hz	1080/59.94p	720/59.94p	640x480/59.94p
29.97Hz	1080/29.97p	720/29.97p	640x480/29.97p
50Hz	1080/50p	720/50p	640x480/50p
25Hz	1080/25p	720/25p	640x480/25p

* You can't select a resolution that's equal to or greater than the format selected in "VIDEO OUTPUT" → "SCALING."

* Uncompressed (YUY2) and compressed (Motion JPEG) video are supported.

Using the loopback function

Audio from the computer can be input to the V-02HD MK II via USB, mixed with other audio, and returned to the computer (the loopback function).

You can add a narration to music that's played back from your computer and live-stream it, or record it using app on your computer.

Streaming video on the computer

Use the dedicated "Roland Live Streamer" app to stream the video and audio outputted via the USB port of the V-02HD MK II using your computer.

For details on operation, refer to the Owner's Manual included with "Roland Live Streamer."



You can download "Roland Live Streamer" from the Roland website. <https://proav.roland.com/>

* Compressed (Motion JPEG) video is not supported.

Capturing video on the computer

Using dedicated "Roland Live Recorder" software, the video and audio that are output from the V-02HD MK II via USB can be recorded on your computer.

For details on operation, refer to the Owner's Manual included with "Roland Live Recorder."



You can download "Roland Live Recorder" from the Roland website. <https://proav.roland.com/>

* Compressed (Motion JPEG) video is not supported.

What to do when an HD video (1920 x 1080) output via USB changes to SD video (640 x 480)

If you are using a USB cable that doesn't conform to USB 3.0 specs or later, the video output resolution is changed to SD (640 x 480). To output video for streaming to your computer in HD (1920 x 1080), be sure to use a cable that meets the USB 3.0 specs (or later).

* If you connect via an extension cable or a USB hub, the computer might not recognize the unit.

You can check the status of the connected USB cable by following these steps.

1. [MENU] button → "VIDEO OUTPUT" → select "USB OUT" → "OUTPUT STATUS," and press the [VALUE] knob.

This shows the status of the USB cable that's connected.

USB OUT	(1 / 1)
OUTPUT STATUS	CONNECTED(3.0)
CONNECTION RESET	EXEC

OUTPUT STATUS	STATUS
CONNECTED(3.0)	Connected using USB 3.0.
CONNECTED(2.0)	Connected using USB 2.0.
NOT CONNECTED	No connection.

Other Features

Saving/Recalling Settings (Preset Memory)

You can save the current settings, including the video/audio settings and the state of the operating panel, in preset memory and recall those settings for use when necessary. The V-02HD MK II is provided with eight preset memories.

About the last memory function

The V-02HD MK II has a built-in Last Memory feature. Last Memory is a feature that saves the state of the unit that is in effect immediately before power-down, and automatically restores the state at the next startup. The Last Memory feature is enabled by default. If you want the unit to recall a specific preset memory when it starts up, use the PRESET MEMORY menu item "START UP" to specify the preset memory number.

Saving to a preset memory

1. [MENU] button → "PRESET MEMORY" → select "SAVE," and press the [VALUE] knob.

PRESET MEMORY	(1 / 3)
LOAD	1: MEMORY1
SAVE	1: MEMORY1
INITIALIZE	1: MEMORY1
NAME EDIT	1: MEMORY1
START UP	LAST MEMORY

2. Use the [VALUE] knob to specify the save-destination preset memory number (1–8), and press the [VALUE] knob.

A recognition message appears.

SAVE MEMORY 5
ARE YOU SURE?
NO YES

If you want to cancel the operation, press the [MENU] button.

3. Use the [VALUE] knob to select "YES," and press the [VALUE] knob.
The current settings are saved. When the operation is finished, the message "COMPLETE" appears.
4. Press the [MENU] button to close the message.
5. Press the [MENU] button several times to close the menu.

MEMO

- In the PRESET MEMORY menu, set "MEMORY PROTECT" to "ON" if you want to prohibit the preset memories from being saved, initialized, having their names changed and so on.
- The state of the [PHONES] knob (headphone volume) is not saved in preset memory.
- The following settings are common to the unit (one set for the entire unit), and therefore are not saved in preset memory.
 - PRESET MEMORY menu
 - CTL/EXP menu
 - CAPTURE IMAGE menu
 - SYSTEM menu
- You can configure what is included in the preset memory for each menu when a preset memory is recalled. Set this in "LOAD PARAMETER" in the PRESET MEMORY menu.

Recalling a preset memory

1. [MENU] button → "PRESET MEMORY" → select "LOAD," and press the [VALUE] knob.

PRESET MEMORY	(1 / 3)
LOAD	1: MEMORY1
SAVE	1: MEMORY1
INITIALIZE	1: MEMORY1
NAME EDIT	1: MEMORY1
START UP	LAST MEMORY

2. Use the [VALUE] knob to select the preset memory number (1–8) that you want to recall, and press the [VALUE] knob.
A recognition message appears.
If you want to cancel the operation, press the [MENU] button.
3. Use the [VALUE] knob to select "YES," and press the [VALUE] knob.
The settings are recalled. When the operation is finished, the message "COMPLETE" appears.
4. Press the [MENU] button to close the message.
5. Press the [MENU] button several times to close the menu.

Initializing a preset memory

Here's how you can initialize the settings of a specific preset memory to the factory-set condition.

1. [MENU] button → "PRESET MEMORY" → select "INITIALIZE," and press the [VALUE] knob.

PRESET MEMORY	(1 / 3)
LOAD	1: MEMORY1
SAVE	1: MEMORY1
INITIALIZE	1: MEMORY1
NAME EDIT	1: MEMORY1
START UP	LAST MEMORY

2. Use the [VALUE] knob to select the preset memory number (1–8) that you want to initialize, and press the [VALUE] knob.
A recognition message appears.
If you want to cancel the operation, press the [MENU] button.
3. Use the [VALUE] knob to select "YES," and press the [VALUE] knob.
The preset memory is initialized. When the operation is finished, the message "COMPLETE" appears.
4. Press the [MENU] button to close the message.
5. Press the [MENU] button several times to close the menu.

Renaming a preset memory

Here's how to rename a preset memory. You can assign a name of up to 8 characters to each memory.

1. Press the [MENU] button → “PRESET MEMORY” → select “NAME EDIT,” and press the [VALUE] knob.

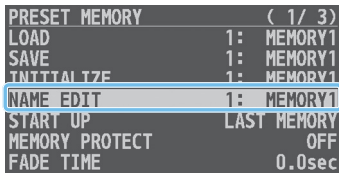

2. Turn the [VALUE] knob to select the preset memory (MEMORY 1–8) that you want to rename, and then press the [VALUE] knob.

The PRESET MEMORY NAME screen appears.

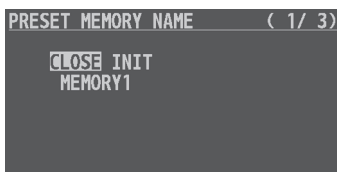

3. Use the [VALUE] knob to select the item that you want to execute, and then press the [VALUE] knob.

Item	Explanation
CLOSE	Saves the memory name and closes the PRESET MEMORY NAME screen.
INIT	Initializes the memory name.
(Memory name)	Edits the memory name (to step 4).

4. Input the memory name.

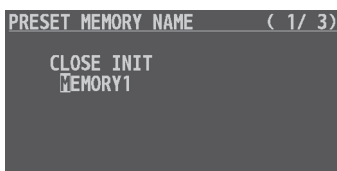

1. Use the [VALUE] knob to move the cursor.

If you move the cursor to a location where there is no character, the number of characters increases.

2. Press the [VALUE] knob to highlight the character at the cursor location.

3. Use the [VALUE] knob to change the character, and then press the [VALUE] knob.

- If you press the [EXIT] button, the character at the cursor location is deleted.
- You can input up to 8 characters.

5. When you have finished inputting the name, use the [VALUE] knob to select “CLOSE,” and then press the [VALUE] knob.

If you decide to cancel, press the [EXIT] button.

6. Press the [MENU] button several times to close the menu.

Using a Footswitch

You can use a footswitch connected to the V-02HD MK II to control the V-02HD MK II with your foot. You can assign various functions to the footswitch.

1. [MENU] button → “CTL/EXP” → select “CTL/EXP TYPE,” and press the [VALUE] knob.

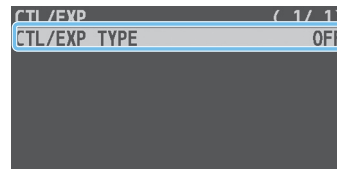

2. Use the [VALUE] knob to specify “CTL A & CTL B” (footswitch) as the device that's connected to the CTL/EXP jack, and press the [VALUE] knob.

The assignable functions are separated by category.

3. Use the [VALUE] knob to select “CTL A ASSIGN-CATEGORY” or “CTL B ASSIGN-CATEGORY,” and press the [VALUE] knob.

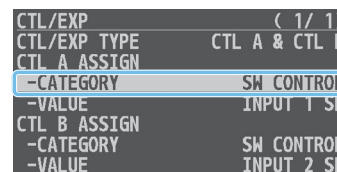

4. Use the [VALUE] knob to select the category of the function to assign to CTL A or CTL B for the footswitch” and press the [VALUE] knob.
5. Use the [VALUE] knob to select “CTL A ASSIGN-VALUE” or “CTL B ASSIGN-VALUE,” and press the [VALUE] knob.
6. Use the [VALUE] knob to select the function that you want to assign to CTL A or CTL B of the footswitch,” and press the [VALUE] knob.

Category/ Value	Explanation
N/A	No function is assigned.
SW CONTROL	-
INPUT 1 SW	Presses the [1] button.
INPUT 2 SW	Presses the [2] button.
EFFECT TYPE SW	Presses the [TYPE] button.
VFX SW	Turns the [VFX] button on/off.
TAKE	-
← AUTO TAKE →	Switches the video between INPUT 1 and 2.
← CUT →	Switches the video between INPUT 1 and 2 as a cut.
EFFECTS	-
MIX	Switches the video effect to mix (MIX).
WIPE	Switches the video effect to wipe (WIPE).
PinP	Switches the video effect to Picture in Picture (PinP).
KEY	Switches the video effect to key (KEY).
STILL IMAGE	Switches between still image output and normal output.
AUDIO INPUT MUTE	-

Category/ Value	Explanation
AUDIO IN 1	Turns the mute function on/off for AUDIO IN 1.
AUDIO IN 2	Turns the mute function on/off for AUDIO IN 2.
USB IN	Turns the mute function on/off for USB IN.
HDMI IN 1	Turns the mute function on/off for HDMI IN 1.
HDMI IN 2	Turns the mute function on/off for HDMI IN 2.
AUDIO OUTPUT MUTE	-
MASTER OUTPUT	Turns the mute function on/off for MASTER OUTPUT.
AUX	Turns the mute function on/off for AUX.
USB OUT	Turns the mute function on/off for USB OUT.
AUDIO INPUT SOLO	-
AUDIO IN 1	Turns the solo function on/off for AUDIO IN 1.
AUDIO IN 2	Turns the solo function on/off for AUDIO IN 2.
USB IN	Turns the solo function on/off for USB IN.
HDMI IN 1	Turns the solo function on/off for HDMI IN 1.
HDMI IN 2	Turns the solo function on/off for HDMI IN 2.
VOICE CHANGE SW	-
AUDIO IN 1	Turns the voice changer function on/off for AUDIO IN 1.
AUDIO IN 2	Turns the voice changer function on/off for AUDIO IN 2.
REVERB(MOMENTARY)	Reverb turns on only while you press the footswitch.
REVERB(ALTERNATE)	Turns the reverb function on/off.
OUTPUT FADE	-
LEFT	Switches the [OUTPUT FADE] knob position (center / turned fully counter-clockwise).
RIGHT	Switches the [OUTPUT FADE] knob position (center / turned fully clockwise).
LOAD MEMORY	-
MEMORY 1-8	Recalls MEMORY 1-8.
MEMORY SCAN	-
NORMAL	Consecutively switches the preset memory in the order of 1 → 8 each time you press.
REVERSE	Consecutively switches the preset memory in the order of 8 → 1 each time you press.

MEMO

If a single-pedal type footswitch such as the BOSS FS-5U is connected using a phone cable (mono), the function assigned by "CTL B ASSIGN" is enabled.

NOTE

The BOSS FS-6's jacks A, B, and A&B also act as the power switch. The power turns on when you insert a plug into the jack, and turns off when you remove the plug.

To prevent the batteries from running down, remove the plugs from the jacks when you're not using the BOSS FS-6.

7. Press the [MENU] button several times to close the menu.

Using an Expression Pedal

You can use an expression pedal connected to the V-02HD MK II to control the V-02HD MK II with your foot.

Adjusting the pedal (pedal calibration)

The first time you use an expression pedal, you must calibrate (adjust) the pedal so that it will operate optimally.

In some cases, an expression pedal might no longer operate optimally due to the passage of time or changes in the operating conditions. If you notice problems such as slight movements of the pedal causing a major change in volume, or if the video fails to switch when you press the pedal, you should execute calibration.

1. [MENU] button → “CTL/EXP” → select “CTL/EXP TYPE,” and then press the [VALUE] knob.



2. Use the [VALUE] knob to specify “EXP” (expression pedal) as the device that’s connected to the CTL/EXP jack, and then press the [VALUE] knob.

3. Use the [VALUE] knob to select “EXP CALIBRATE,” and then press the [VALUE] knob.

The EXP CALIBRATE screen appears.

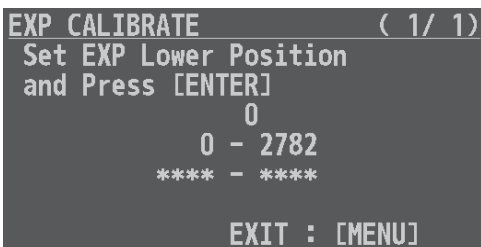

4. As directed by the screen, step on the pedal in the fully heel-down position, and press the [VALUE] knob.
5. As directed by the screen, step on the pedal in the fully toe-down position, and press the [VALUE] knob.

When the “Complete” indication appears, calibration is completed.

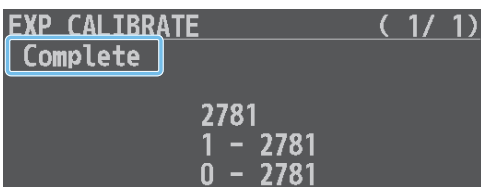

6. Press the [MENU] button several times to close the menu.

MEMO

You should normally use the EV-5 with its minimum volume knob left in the zero position.

* If you change the position of the minimum volume knob, you must execute pedal calibration.

Assigning a function to the pedal

You can assign various functions to the expression pedal.

1. [MENU] button → “CTL/EXP” → select “CTL/EXP TYPE,” and then press the [VALUE] knob.

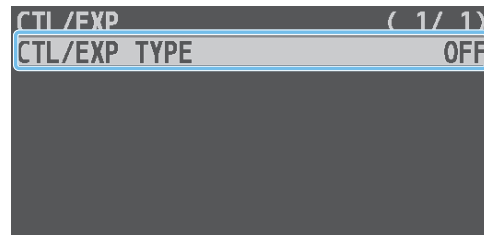

2. Use the [VALUE] knob to specify “EXP” (expression pedal) as the device that’s connected to the CTL/EXP jack, and then press the [VALUE] knob.

The assignable functions are separated by category.

3. Use the [VALUE] knob to select “EXP ASSIGN-CATEGORY,” and then press the [VALUE] knob.



4. Use the [VALUE] knob to select the category of the function to assign to the expression pedal, and then press the [VALUE] knob.
5. Use the [VALUE] knob to select “EXP ASSIGN-VALUE,” and then press the [VALUE] knob.
6. Use the [VALUE] knob to select the function that you want to assign to the expression pedal, and then press the [VALUE] knob.

Category/ Value	Explanation
N/A	No function is assigned.
VIDEO FADER	-
FADE	Slides the video fader to the left edge or right edge.
← CUT →	Switches (cuts) between the video being input to INPUT 1 and 2.
VFX MIX LEVEL	Adjusts the density (output level) of the video that is processed by the visual effect.
OUTPUT FADE	-
LEFT	Turns the [OUTPUT FADE] knob counterclockwise.
RIGHT	Turns the [OUTPUT FADE] knob clockwise.
STILL IMAGE	Switches between still image output and normal output.

Category/ Value	Explanation
AUDIO LEVEL	-
AUDIO IN 1	Adjusts the volume of AUDIO IN 1.
AUDIO IN 2	Adjusts the volume of AUDIO IN 2.
USB IN	Adjusts the volume of USB IN.
HDMI IN 1	Adjusts the volume of HDMI IN 1.
HDMI IN 2	Adjusts the volume of HDMI IN 2.
MASTER OUTPUT	Adjusts the MASTER OUTPUT volume.
AUX	Adjusts the AUX volume.
USB OUT	Adjusts the USB OUT volume.
VOICE CHANGER	-
AUDIO IN 1 PITCH	Adjusts the pitch of AUDIO IN 1.
AUDIO IN 1 FORMANT	Adjusts the formant of AUDIO IN 1.
AUDIO IN 1 MIX	Adjusts the mix of AUDIO IN 1.
AUDIO IN 2 PITCH	Adjusts the pitch of AUDIO IN 2.
AUDIO IN 2 FORMANT	Adjusts the formant of AUDIO IN 2.
AUDIO IN 2 MIX	Adjusts the mix of AUDIO IN 2.
REVERB LEVEL	Adjusts the reverb level.

7. Press the [MENU] button several times to close the menu.

Preventing Unintended Operation (Panel Lock)

Here's how you can lock the V-02HD MK II's buttons and knobs to prevent unintended operation.

1. [MENU] button → "SYSTEM" → select "PANEL LOCK," and press the [VALUE] knob.

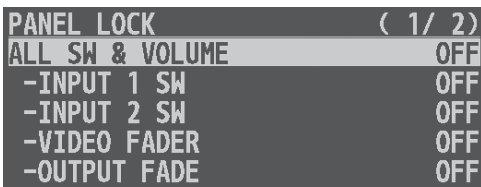
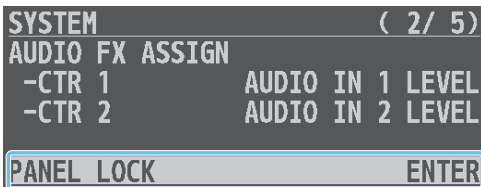

The PANEL LOCK menu appears.

2. Use the [VALUE] knob to select a target for panel lock, and press the [VALUE] knob.

Menu item	Explanation
ALL SW & VOLUME	The settings of the following buttons and knobs are turned on/off together.
INPUT 1 SW	[1] button
INPUT 2 SW	[2] button
VIDEO FADER	Video fader
OUTPUT FADE	[OUTPUT FADE] knob
VFX SW	[VFX] button
EFFECT TYPE SW	[TYPE] button
CONTROL 1 ENCODER	[CONTROL 1] knob
CONTROL 2 ENCODER	[CONTROL 2] knob

3. Use the [VALUE] knob to specify whether panel lock is applied (ON) or not applied (OFF), and press the [VALUE] knob.
4. Repeat steps 2–3 as necessary.
5. Press the [MENU] button several times to close the menu.

Returning to the Factory Settings (Factory Reset)

Here's how you can return the settings of the V-02HD MK II to their factory-set state. If following the procedures described in this manual does not cause the result you expect, try executing a factory reset.

NOTE

- When you execute factory reset, any previously specified content, any settings saved in preset memory (p. 31), and the still image (p. 20) saved in the unit will all be lost.
- It takes approximately 40 seconds for factory reset to be completed. Do not turn off the power while the "PLEASE WAIT" message is shown.

1. [MENU] button → "SYSTEM" → select "FACTORY RESET," and press the [VALUE] knob.

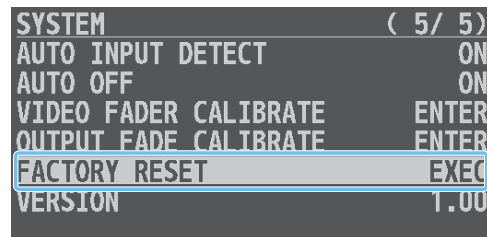

A recognition message appears.

If you want to cancel the operation, press the [MENU] button.

2. Use the [VALUE] knob to select "YES," and press the [VALUE] knob.
 Factory reset is executed. When the operation is finished, the message "COMPLETE" appears.
3. Press the [MENU] button to close the message.
4. Press the [MENU] button several times to close the menu.

MEMO

If the sample material was overwritten by still image capture (p. 20), the sample material returns to its original state when you execute factory reset.

Switching Video Automatically (Auto Switching)

This function automatically switches the INPUT video or PRESET MEMORY. You can simplify operation by making the video switch automatically.

Auto Switching Operation Modes

As appropriate for your situation, you can choose two auto switching operation modes: "input scan" or "preset memory scan."

- **Automatically switching the INPUT video (Input scan)**
The video of INPUT 1 and INPUT 2 is switched automatically.

- **Automatically switching the PRESET MEMORY (Preset memory scan)**

Preset memories 1–8 are switched automatically.

Specifying the Operation Mode

Input scan

1. [MENU] button → "VIDEO INPUT" → select "AUTO SWITCHING," and press the [VALUE] knob.



2. Use the [VALUE] knob to set "TYPE" to "INPUT SCAN," and then press the [VALUE] knob



3. Use the [VALUE] knob to select "TIME," and press the [VALUE] knob
4. Use the [VALUE] knob to select a menu item, and then press the [VALUE] knob.
5. Use the [VALUE] knob to edit the value of the setting, and then press the [VALUE] knob.

Menu item	Explanation
INPUT 1 TIME	Specifies the time during which the video is shown. If this is "OFF," video switching does not apply to this input.
INPUT 2 TIME	Specifies the time during which the video is shown. If this is "OFF," video switching does not apply to this input.
SCAN TRANSITION TIME	Specifies the scan transition time.

6. Use the [VALUE] knob to set "AUTO SWITCHING" to "ON," and then press the [VALUE] knob.
7. Press the [MENU] button several times to close the menu.

Preset memory scan

1. [MENU] button → "VIDEO INPUT" → select "AUTO SWITCHING."
2. Use the [VALUE] knob set "TYPE" to "PRESET MEMORY SCAN," and then press the [VALUE] knob.



3. Use the [VALUE] knob to select "TIME," and press the [VALUE] knob.
4. Use the [VALUE] knob to select a menu item, and then press the [VALUE] knob.
5. Turn the [VALUE] knob to edit the value of the setting, and then press the [VALUE] knob.

Menu item	Explanation
MEMORY 1–8 TIME	Specifies the time during which the memory is shown. If this is "OFF," video switching does not use this memory.

- Preset memories that do not have an "*" symbol are not used with video switching.
6. Use the [VALUE] knob to select "SEQUENCE," and press the [VALUE] knob.
 7. Turn the [VALUE] knob to edit the value of the setting, and then press the [VALUE] knob.

Menu item	Explanation
SEQUENCE	Specifies the scan sequence. NORMAL: Switch consecutively from MEMORY1. REVERSE: Switch in the opposite direction from NORMAL. RANDOM: Switch randomly.

8. Use the [VALUE] knob to set "AUTO SWITCHING" to "ON," and then press the [VALUE] knob.
9. Press the [MENU] button several times to close the menu.

Menu List

Pressing the [MENU] button makes the menu appear on the display connected to the PREVIEW OUT connector.



MEMO

- By turning the [VALUE] knob while pressing it, you can change the value more greatly.
- Long-pressing the [VALUE] knob returns the current menu item you're setting to its default value.

1: VIDEO INPUT

Menu item	Value (bold text: default value)	Explanation
INPUT 1, 2	Adjusts the image that is input from the INPUT 1 and 2 connectors.	
INPUT STATUS	(ENTER)	Displays information about the incoming video (format, size, etc.).
FLICKER FILTER	OFF , ON	If this is "ON," flickering is reduced.
FLIP H	OFF , ON	If this is "ON," the video is input with left and right flipped.
FLIP V	OFF , ON	If this is "ON," the video is input with top and bottom flipped.
EDID	INTERNAL SVGA (800 x 600) XGA (1024 x 768) WXGA (1280 x 800) FWXG (1366 x 768) SXGA (1280 x 1024) SXGA+ (1400 x 1050) UXGA (1600 x 1200) WUXGA (1920 x 1200) 720p 1080i 1080p	Specifies the input format (EDID). If this is "INTERNAL," EDID information for all formats that can be input to the V-02HD MK II will be transmitted. What is EDID? EDID is data that is transmitted from the V-02HD MK II to the source device when the V-02HD MK II is connected to a source device. EDID contains data such as the formats that can be input to the V-02HDMKII (resolution, color space, color depth) and audio information. Based on the EDID information that the source device receives, it will output the most appropriate video format to the V-02HD MK II.
SHARED INPUT (INPUT 2 only)	OFF , ON	This is the video source sharing setting. If this is "ON," the INPUT 1 input video is assigned.
ZOOM	10.0– 100.0 –1000.0% (*1)	Adjusts the zoom ratio.
SCALING TYPE	Specifies the scaling type.	
	FULL	Always displays the picture expanded to full screen, irrespective of the aspect ratio of the input video.
	LETTERBOX	Enlarges or reduces the incoming video to a full-screen view while keeping the aspect ratio unchanged.
	CROP	Enlarges or reduces the incoming video so that the output picture has no blank margins while keeping the aspect ratio unchanged. Video extending beyond the borders is cut off.
	DOT BY DOT	Performs no scaling.
MANUAL SIZE H (*2)	-2000– 0 –2000 (*1)	Adjusts the horizontal size.
MANUAL SIZE V (*2)	-2000– 0 –2000 (*1)	Adjusts the vertical size.
POSITION H	-1920– 0 –1920	Adjusts the display position in the horizontal direction.
POSITION V	-1200– 0 –1200	Adjusts the display position in the vertical direction.
BRIGHTNESS	-64– 0 –63	Adjusts the brightness.
CONTRAST	-64– 0 –63	Adjusts the contrast.
SATURATION	-64– 0 –63	Adjusts the saturation.
RED	-64– 0 –63	Adjusts the red level.
GREEN	-64– 0 –63	Adjusts the green level.
BLUE	-64– 0 –63	Adjusts the blue level.

(*1) The valid range of setting values depends on conditions such as the input/output format.

(*2) This is valid when "SCALING TYPE" is set to "MANUAL."

2: VIDEO OUTPUT









Menu item	Value (bold text: default value)	Explanation	
PROGRAM OUT	Adjusts the program output video (the video that is output from the PROGRAM OUT connector).		
OUTPUT STATUS	—	Displays information about the output video (format and presence or absence of an HDCP signal). When no connection is in effect, "NOT CONNECTED" is displayed.	
COLOR SPACE	YPbPr(4:4:4) , YPbPr(4:2:2), RGB(0–255), RGB(16–235)	Specifies the color space (system for representing colors in video).	
DVI-D/HDMI SIGNAL	HDMI , DVI-D	Specifies the output mode for HDMI output.	
BRIGHTNESS	-64– 0 –63	Adjusts the brightness.	
CONTRAST	-64– 0 –63	Adjusts the contrast.	
SATURATION	-64– 0 –63	Adjusts the saturation.	
RED	-64– 0 –63	Adjusts the red level.	
GREEN	-64– 0 –63	Adjusts the green level.	
BLUE	-64– 0 –63	Adjusts the blue level.	
PREVIEW OUT	Adjusts the preview output video (the video that is output from the PREVIEW OUT connector).		
OUTPUT STATUS	—	Displays information about the output video (format and presence or absence of an HDCP signal).	
OUTPUT ASSIGN	Specifies the video that is output from the PREVIEW OUT connector.		
	PROGRAM	Output the program video.	
	PREVIEW	Output the preview video (standby video).	
COLOR SPACE	YPbPr(4:4:4) , YPbPr(4:2:2), RGB(0–255), RGB(16–235)	Specifies the color space (system for representing colors in video).	
DVI-D/HDMI SIGNAL	HDMI , DVI-D	Specifies the output mode for HDMI output.	
BRIGHTNESS	-64– 0 –63	Adjusts the brightness.	
CONTRAST	-64– 0 –63	Adjusts the contrast.	
SATURATION	-64– 0 –63	Adjusts the saturation.	
RED	-64– 0 –63	Adjusts the red level.	
GREEN	-64– 0 –63	Adjusts the green level.	
BLUE	-64– 0 –63	Adjusts the blue level.	
SCALING	Adjusts the output format settings, and the position and size of the output video.		
FORMAT	480p (*3) 576p (*4) 720p 1080i 1080p SVGA (800 x 600) XGA (1024 x 768) WXGA (1280 x 800) FWXG (1366 x 768) SXGA (1280 x 1024) SXGA+ (1400 x 1050) UXGA (1600 x 1200) WUXGA (1920 x 1200) HD (1280 x 720) FHD (1920 x 1080)	Specifies the output format. * A change in the setting is not applied until you press the [VALUE] knob to confirm. * Reconnects the computer when the video is garbled or when operation is otherwise unstable. (*3) This is valid when "FRAME RATE" is set to "59.94 Hz." (*4) This is valid when "FRAME RATE" is set to "50 Hz."	
	ZOOM	10.0– 100.0 –1000%	Adjusts the zoom ratio.
	SIZE H	-2000– 0 –2000 (*5)	Adjusts the horizontal size.
	SIZE V	-2000– 0 –2000 (*5)	Adjusts the vertical size.
	POSITION H	-1920– 0 –1920	Adjusts the display position in the horizontal direction.
	POSITION V	-1200– 0 –1200	Adjusts the display position in the vertical direction.
	USB OUT	Adjusts the video that is output from the USB STREAM port.	
	OUTPUT STATUS	—	Displays information about the output video (format and presence or absence of an HDCP signal).
	OUTPUT ASSIGN	Specifies the video that is output from the USB STREAM port.	
		PROGRAM	Output the program video.
		PREVIEW	Output the preview video (standby video).
	CONNECTION RESET	(ENTER)	Reconnects the computer when the video is garbled or when operation is otherwise unstable.
OUTPUT FORMAT	YUY2 & MJPEG, YUY2	Sets the output destination formats that can be selected from the livestreaming app. YUY2 & MJPEG : YUY2 and MJPEG are selectable. YUY2 : Only YUY2 is selectable.	

(*5) The valid range of setting values depends on conditions such as the input/output format.

3: TRANSITION TIME

Menu item	Value (bold text: default value)	Explanation
MIX/WIPE TIME	0.0– 1.0 –4.0sec	Specifies the video transition time.
PinP TIME	0.0– 1.0 –4.0sec	Specifies the fade time with which the inset screen appears or disappears when using Picture in Picture (PinP) compositing.
KEY TIME	0.0– 1.0 –4.0sec	Specifies the fade time with which the superimposed logo or video appears or disappears when using luminance key or chroma key compositing.



4: MIX/WIPE

Menu item	Value (bold text: default value)	Explanation			
MIX TYPE	Specifies the transition pattern for mix.				
	MIX	The two videos are mixed as the transition occurs.			
	FAM	Video transitions are made with the luminance levels of the two video streams maintained unchanged. This is an abbreviation of "full additive mix."			
	NAM	The two video streams are compared, and transitions are made with display during transition starting with levels of high luminance. This is an abbreviation of "non-additive mix."			
WIPE TYPE	Specifies the transition pattern for wipe.				
	HORIZONTAL	VERTICAL	UPPER LEFT	UPPER RIGHT	LOWER LEFT
					
	LOWER RIGHT	H-CENTER	V-CENTER	BOX	
					
	WIPE DIRECTION	NORMAL , REVERSE, ROUND TRIP	Specifies the direction of wipe.		
	WIPE BORDER COLOR	WHITE , YELLOW, CYAN, GREEN, MAGENTA, RED, BLUE, BLACK, SOFTEDGE	Specifies the color of the border added to the edge of the wipe area. If this is set to "SOFTEDGE," the wipe border is blurred.		
WIPE BORDER WIDTH	0– 2 –15	Specifies the width of the border added to the edge of the wipe area.			

5: PinP

Menu item	Value (bold text: default value)	Explanation
WINDOW	Adjusts the inset screen.	
POSITION H	-100.0– -40.0 –100.0%	Adjusts the horizontal display position of the inset screen.
POSITION V	-100.0– -40.0 –100.0%	Adjusts the vertical display position of the inset screen.
SIZE	10.0– 35.0 –100.0%	Adjusts the size (zoom) of the inset screen.
CROPPING H	0.0– 100.0%	Adjusts the horizontal size of the inset screen.
CROPPING V	0.0– 100.0%	Adjusts the vertical size of the inset screen.
SHAPE	RECTANGLE , CIRCLE, DIAMOND	Specifies the shape of the inset screen.
BORDER COLOR	WHITE , YELLOW, CYAN, GREEN, MAGENTA, RED, BLUE, BLACK, SOFTEDGE	Specifies the color of the border for the inset screen. If this is set to "SOFTEDGE," the edge of the inset screen is blurred.
BORDER WIDTH	0– 1 –15	Adjusts the width of the border for the inset screen.
VIEW	Adjusts the video that is shown in the inset screen.	
POSITION H	-50.0– 0.0 –50.0%	Adjusts the horizontal position at which the inset screen is shown.
POSITION V	-50.0– 0.0 –50.0%	Adjusts the vertical position at which the inset screen is shown.
ZOOM	100.0 –1000.0%	Adjusts the zoom of the inset screen.
PinP PROGRAM OUT MODE	Specifies how the unit operates immediately after the [TYPE] button selects "PinP" (Picture in Picture).	
	MANUAL	The composited result is sent to preview output. This lets you check the position and size of the inset screen before sending it to program output.
	AUTO	The composited result is sent to program output.

6: KEY

Menu item	Value (bold text: default value)	Explanation
KEY SOURCE	Specifies the source of the logo or video that is overlaid when using key compositing.	
	INPUT 1, 2	The video of INPUT 1 or 2
	STILL IMAGE	A captured still image
KEY TYPE	Specifies the key type used during key composition.	
	LUMINANCE-WHITE	Makes white portions transparent according to brightness.
	LUMINANCE-BLACK	Makes black portions transparent according to brightness.
	CHROMA	Makes the specified key color transparent according to hue.
KEY LEVEL	0– 64 –255	Adjusts the degree of extraction (transparency) for the key.
KEY GAIN	0 –255	Adjusts the degree of edge blur (semi-transmissive region) for the key.
MIX LEVEL	0– 255	Adjusts the key's overall density (output level).
WINDOW (*6)	These parameters adjust the border of the composite screen.	
POSITION H	-100.0–40.0–100.0%	Adjusts the horizontal display position.
POSITION V	-100.0–40.0–100.0%	Adjusts the vertical display position.
SIZE	10.0–100.0%	Adjusts the size (zoom).
CROPPING H	0.0–100.0%	Adjusts the horizontal size.
CROPPING V	0.0–100.0%	Adjusts the vertical size.
VIEW (*6)	These parameters adjust the video that is shown in the composite screen.	
POSITION H	-50.0–0.0–50.0%	Adjusts the horizontal display position.
POSITION V	-50.0–0.0–50.0%	Adjusts the vertical display position.
ZOOM	100.0–1000.0%	Adjusts the zoom.
CHROMA	Make detailed settings for chroma key.	
COLOR (*7)	GREEN, BLUE	Specifies green or blue as the key color (the color to be removed). If you want a color other than green or blue to turn transparent, use "SAMPLING MARKER" to specify the key color.
HUE WIDTH (*7)	-30– 0 –30	Adjusts the hue width for the key color.
HUE FINE (*7)	0– 120 –360	Adjusts the center position of the hue for the key color.
SATURATION WIDTH (*7)	-30– 0 –30	Adjusts the saturation width for the key color.
SATURATION FINE (*7)	0 –255	Adjusts the center position of saturation for the key color.
SAMPLING MARKER (*8)	OFF , ON	If this is "ON," a sampling marker () is shown on the preview output video for you to sample (detect) the key color. When you execute sampling, the setting automatically turns "OFF."
POSITION H (*9)	-100.0– -25.0 –100.0%	Adjusts the horizontal position of the sampling marker (). You can use the [CONTROL 1] knob to adjust this.
POSITION V (*9)	-100.0– -25.0 –100.0%	Adjusts the vertical position of the sampling marker (). You can use the [CONTROL 2] knob to adjust this.
SAMPLING EXECUTE (*9)	(EXEC)	Executes key color sampling. The "HUE WIDTH," "HUE FINE," "SATURATION WIDTH," and "SATURATION FINE" settings are adjusted automatically.
FILL TYPE	BUS , MATTE	If this is "MATTE," the superimposed logo or video is filled-in with the specified color when using key compositing. The fill-in color is specified by "MATTE COLOR" below.
MATTE COLOR (*10)	WHITE, YELLOW, CYAN, GREEN, MAGENTA, RED , BLUE, BLACK	Specifies the color used when filling-in the superimposed logo or video.
EDGE TYPE	OFF , BORDER, DROP, SHADOW, OUTLINE	Specifies the type of edge applied to the superimposed logo or video.
EDGE COLOR	WHITE, YELLOW, CYAN, GREEN, MAGENTA, RED, BLUE, BLACK	Specifies the color of the edge applied to the superimposed logo or video.
EDGE WIDTH	0– 4 –15	Specifies the width of the edge applied to the superimposed logo or video.
KEY PROGRAM OUT MODE	Specifies how the unit operates immediately after the [TYPE] button selects "KEY."	
	MANUAL	The composited result is sent to preview output. This lets you check the superimposed logo or video before sending it to the program output.
	AUTO	The composited result is sent to program output.

(*6) This is valid when "KEY SOURCE" is set to "INPUT 1" or "INPUT 2."

(*7) This is valid when "KEY TYPE" is set to "CHROMA."

(*8) This is valid when "KEY TYPE" is set to "CHROMA" and the [TYPE] button has selected "KEY."

(*9) This is valid when "SAMPLING MARKER" is set to "ON."

(*10) This is valid when "FILL TYPE" is set to "MATTE."

7: VFX

The menu items named “CONTROL 1–” and “CONTROL 2–” for each visual effect can be controlled by the [CONTROL 1] and [CONTROL 2] knobs when the visual effect is on.

Menu item	Value (bold text: default value)	Explanation
VFX	OFF , ON	Turns the visual effect on/off. You can also use the [VFX] button to turn this on/off.
VFX TYPE	PART MOSAIC , BACKGROUND MOSAIC, FULL MOSAIC, WAVE, RGB REPLACE, COLORPASS, NEGATIVE, COLORIZE, POSTERIZE, SILHOUETTE, EMBOSS, FIND EDGES, MONOCOLOR, HUE OFFSET, SATURATION OFFSET, VALUE OFFSET	Specifies the visual effect. * The menu items are different for each visual effect.

VFX TYPE = PART MOSAIC (Applies a mosaic to the selected region.)

Menu item	Value (bold text: default value)	Explanation
CONTROL 1 POSITION H	-100.0– 0.0 –100.0%	Adjusts the horizontal position of the selected area.
CONTROL 2 POSITION V	-100.0– 0.0 –100.0%	Adjusts the vertical position of the selected area.
MIX LEVEL	0–255	Adjusts the intensity (output level) of the video with the visual effect applied.
AREA SIZE	10.0– 40.0 –100.0%	Adjusts the size (zoom) of the selected area. When the visual effect is on, you can adjust this by turning the [CONTROL 1] knob while pressing it.
CORRECTION H (*11)	-2000– 0 –2000	Adjusts the horizontal size of the selected area.
CORRECTION V (*11)	-2000– 0 –2000	Adjusts the vertical size of the selected area.
BLOCK SIZE	OFF (1x1), 4 x 4, 8 x 8, 16 x 16, 32 x 32, 64 x 64 , 128 x 128, 256 x 256	Specifies the fineness (block size) of the mosaic. When the visual effect is on, you can adjust this by turning the [CONTROL 2] knob while pressing it.

(*11) The valid range of setting values depends on conditions such as the input/output format.

VFX TYPE = BACKGROUND MOSAIC (Applies a mosaic to the portion outside the selected region.)

Menu item	Value (bold text: default value)	Explanation
CONTROL 1 POSITION H	-100.0– 0.0 –100.0%	Adjusts the horizontal position of the selected area.
CONTROL 2 POSITION V	-100.0– 0.0 –100.0%	Adjusts the vertical position of the selected area.
MIX LEVEL	0–255	Adjusts the intensity (output level) of the video with the visual effect applied.
AREA SIZE	10.0– 40.0 –100.0%	Adjusts the size (zoom) of the selected area. When the visual effect is on, you can adjust this by turning the [CONTROL 1] knob while pressing it.
CORRECTION H (*12)	-2000– 0 –2000	Adjusts the horizontal size of the selected area.
CORRECTION V (*12)	-2000– 0 –2000	Adjusts the vertical size of the selected area.
BLOCK SIZE	OFF (1x1), 4 x 4, 8 x 8, 16 x 16, 32 x 32, 64 x 64 , 128 x 128, 256 x 256	Specifies the fineness (block size) of the mosaic. When the visual effect is on, you can adjust this by turning the [CONTROL 2] knob while pressing it.

(*12) The valid range of setting values depends on conditions such as the input/output format.

VFX TYPE = FULL MOSAIC (Applies a mosaic to the entire screen.)

Menu item	Value (bold text: default value)	Explanation
CONTROL 1 BLOCK SIZE	OFF (1x1), 4 x 4, 8 x 8, 16 x 16, 32 x 32, 64 x 64 , 128 x 128, 256 x 256	Specifies the fineness (block size) of the mosaic.
CONTROL 2 N/A	- - - (no settings)	—
MIX LEVEL	0–255	Adjusts the intensity (output level) of the video with the visual effect applied.

VFX TYPE = WAVE (Makes the video wavy.)

Menu item	Value (bold text: default value)	Explanation
CONTROL 1 GAIN	0–127 –255	Adjust the height of the waves.
CONTROL 2 TYPE	1– 4 –7	Specifies the number of waves.
MIX LEVEL	0–255	Adjusts the intensity (output level) of the video with the visual effect applied.

VFX TYPE = RGB REPLACE (Exchanges the colors.)

Menu item	Value (bold text: default value)	Explanation
CONTROL 1 TYPE	OFF (R.G.B), B.R.G , G.B.R, R.B.G, G.R.B, B.G.R	Specifies the type of RGB replace.
CONTROL 2 N/A	--- (no settings)	—
MIX LEVEL	0-255	Adjusts the intensity (output level) of the video with the visual effect applied.

VFX TYPE = COLOR PASS (Turns the video black and white while preserving a specific color.)

Menu item	Value (bold text: default value)	Explanation
CONTROL 1 TYPE	1- 42 -63	Specifies the type of color pass.
CONTROL 2 N/A	--- (no settings)	—
MIX LEVEL	0-255	Adjusts the intensity (output level) of the video with the visual effect applied.

VFX TYPE = NEGATIVE (Inverts the brightness and colors.)

Menu item	Value (bold text: default value)	Explanation
CONTROL 1 TYPE	Cr, Cb, CbCr, Y , YCr, YCb, YCbCr	Specifies the type of negative.
CONTROL 2 N/A	--- (no settings)	—
MIX LEVEL	0-255	Adjusts the intensity (output level) of the video with the visual effect applied.

VFX TYPE = COLORIZE (Adds color to the video.)

Menu item	Value (bold text: default value)	Explanation
CONTROL 1 TYPE	1 -8	Specifies the type of colorize.
CONTROL 2 N/A	--- (no settings)	—
MIX LEVEL	0-255	Adjusts the intensity (output level) of the video with the visual effect applied.

VFX TYPE = POSTERIZE (Changes the gradations in brightness.)

Menu item	Value (bold text: default value)	Explanation
CONTROL 1 LEVEL	1- 3 -4	Specifies the gradation level for brightness.
CONTROL 2 N/A	--- (no settings)	—
MIX LEVEL	0-255	Adjusts the intensity (output level) of the video with the visual effect applied.

VFX TYPE = SILHOUETTE (Separates the video into light and dark areas, and makes the dark areas black and adds a different color to the light areas.)

Menu item	Value (bold text: default value)	Explanation
CONTROL 1 TYPE	1 -128	Specifies the hue to be colorized.
CONTROL 2 N/A	--- (no settings)	—
MIX LEVEL	0-255	Adjusts the intensity (output level) of the video with the visual effect applied.

VFX TYPE = EMBOSS (Adds a bas-relief effect to the video.)

Menu item	Value (bold text: default value)	Explanation
CONTROL 1 TYPE	1 -128	Specifies the type of emboss.
CONTROL 2 CONTRAST	0 -15	Adjusts the contrast.
MIX LEVEL	0-255	Adjusts the intensity (output level) of the video with the visual effect applied.

VFX TYPE = FIND EDGES (Extracts contours.)

Menu item	Value (bold text: default value)	Explanation
CONTROL 1 FG COLOR	0 -15	Specifies the color of the edge.
CONTROL 2 BG COLOR	0-3 -15	Specifies the color of the background.
MIX LEVEL	0-255	Adjusts the intensity (output level) of the video with the visual effect applied.

VFX TYPE = MONOCOLOR (Turns the video monochrome.)

Menu item	Value (bold text: default value)	Explanation
CONTROL 1 Pb COLOR	0 -63	Adjusts the blue component.
CONTROL 2 Pr COLOR	0 -63	Adjusts the red component.
MIX LEVEL	0-255	Adjusts the intensity (output level) of the video with the visual effect applied.

VFX TYPE = HUE OFFSET (Changes the visual character by controlling the hue.)

Menu item	Value (bold text: default value)	Explanation
CONTROL 1 VALUE	0– 180 –359	Specifies the reference value for hue.
CONTROL 2 N/A	--- (no settings)	—
MIX LEVEL	0– 255	Adjusts the intensity (output level) of the video with the visual effect applied.

VFX TYPE = SATURATION OFFSET (Changes the visual character by controlling the saturation.)

Menu item	Value (bold text: default value)	Explanation
CONTROL 1 VALUE	-255– 0 –255	Specifies the reference value for saturation.
CONTROL 2 N/A	--- (no settings)	—
MIX LEVEL	0– 255	Adjusts the intensity (output level) of the video with the visual effect applied.

VFX TYPE = VALUE OFFSET (Changes the visual character by controlling the brightness.)

Menu item	Value (bold text: default value)	Explanation
CONTROL 1 VALUE	-255– 0 –255	Specifies the reference value for brightness.
CONTROL 2 N/A	--- (no settings)	—
MIX LEVEL	0– 255	Adjusts the intensity (output level) of the video with the visual effect applied.

8: AUDIO INPUT

Menu item	Value (bold text: default value)	Explanation	
AUDIO IN 1, 2	Adjusts the audio that is input from the AUDIO IN 1 and 2 connectors.		
ANALOG GAIN	0–55dB	Adjusts the input gain.	
INPUT LEVEL	-INF– 0.0 –10.0dB	Adjusts the input volume.	
INPUT MUTE	OFF , ON	Turns the mute function on/off. If this is “ON,” the input audio is temporarily silenced.	
PLUG-IN POWER	OFF , ON	Turns the plug-in power on/off. If this is “ON,” plug-in power is supplied via the AUDIO IN jack.	
MONO	OFF	Sends the stereo input audio without change.	
	L ONLY	The audio of the L channel is sent to both L and R.	
	R ONLY	The audio of the R channel is sent to both L and R.	
	LR MIX	The audio of the L channel and R channel is mixed, and sent to both L and R.	
SOLO	OFF , ON	Turns the solo function on/off. Only the audio for which this is “ON” is heard in the headphones. * The solo function applies to the headphone output. It does not affect output other than the headphones.	
EFFECT PRESET	Specifies an effect preset (high-pass filter, compressor, equalizer). * When you change a preset, the settings of each effect are overwritten.		
	DEFAULT	For line input (default setting)	
	MEETING	For meetings	
	INTERVIEW	For interviews	
	AMBIENT MIC	For capturing ambient sound	
	WINDY FIELD	For capturing ambient sound in a windy area	
DELAY	0.0 –500.0msec (0 –29.9f/25.0f)	Adjusts the delay time of the audio. Effect Outputs audio with a delay.	
REVERB SEND	0 –127	Adjusts the amount of audio sent to reverb. Effect This adds reverberation to the sound.	
HIGH PASS FILTER 80Hz	OFF , ON	Turns the high-pass filter on/off. Effect Cuts off unneeded low-band audio. The cutoff frequency is 80 Hz.	
NOISE GATE	OFF , ON	Turns the noise gate on/off. Effect Mutes audio that is below a specified level.	
	THRESHOLD	-80– -48 –0dB	Specifies the level used as the threshold for removing audio. Audio below the level set here is removed.
	RELEASE	30– 500 –5000ms	Adjusts the length of time until the audio is fully attenuated after audio falls below the threshold.
DE-ESSER	OFF , ON	Turns the de-esser on/off. Effect Reduces sibilant noise (the sounds you hear when pronouncing “s” words and other hissing sounds).	
	SENS	0– 80 –100	Adjusts the sensitivity with which sibilants are detected.

Menu item	Value (bold text: default value)	Explanation
DEPTH	0- 64 -100	Adjusts the intensity of the effect.
COMPRESSOR	OFF , ON	Turns the compressor on/off. Effect This compresses audio that exceeds a specified level.
THRESHOLD	-80-- 8 -0dB	Specifies the level used as the threshold at which the compressor is applied. Compression is applied to audio that exceeds the threshold.
RATIO	1.00 : 1, 1.12 : 1, 1.25 : 1, 1.40 : 1, 1.60 : 1, 1.80 : 1, 2.00 : 1, 2.50 : 1 , 3.20 : 1, 4.00 : 1, 5.60 : 1, 8.00 : 1, 16.0 : 1, INF : 1	Specifies the degree of compression applied to the audio. The state in which no compression is applied is defined as "1."
ATTACK	0.0- 30 -100msec	Specifies the time until compression starts when audio exceeding the threshold is input.
RELEASE	30- 250 -5000msec	Adjusts the length of time until compression ends after audio falls below the threshold.
MAKEUP GAIN	-40- 0 -40dB	Adjusts the final output volume level after applying the compressor.
EQUALIZER	OFF , ON	Turns the equalizer on/off. Effect Adjusts the sound quality for each frequency band.
Hi GAIN	-12.0- 0.0 -12.0dB	Boosts or attenuates the high band.
Hi FREQUENCY	1.0- 10.0 -20.0kHz	Adjusts the center frequency when changing the tone quality in the high band.
Mid GAIN	-12.0- 0.0 -12.0dB	Boosts or attenuates the middle band.
Mid FREQUENCY	20.0Hz- 2.00kHz -20.0kHz	Adjusts the center frequency when changing the tone quality in the middle band.
Mid Q	0.5- 1.0 -16.0	Adjusts the width of the frequency band when boosting or attenuating the middle band.
Lo GAIN	-12.0- 0.0 -12.0dB	Boosts or attenuates the low band.
Lo FREQUENCY	20.0Hz- 100Hz -2.00kHz	Adjusts the center frequency when changing the tone quality in the low band.
VOICE CHANGER	OFF , ON	Turns the voice changer on/off. Effect Modify the pitch or character of the voice that's input from a mic.
PITCH	-12- +12	Adjusts the pitch of the voice in semitone steps. A setting of "0" is the original pitch.
FORMANT	-10- +4 +10	Adjusts the character (formant) of the voice. Settings in the negative (-) direction produce a more masculine vocal character, and settings in the positive (+) direction produce a more feminine vocal character. A setting of "0" is the original voice.
ROBOT	OFF , ON	If this is "ON," the voice is held at a fixed pitch, creating a mechanical robot-like impression.
MIX	0- 100	Adjusts the balance between the unprocessed voice (0) and the voice processed by the effect (100).
USB IN	Adjusts the audio that is input from the USB IN.	
INPUT LEVEL	-INF- 0.0 -10.0dB	Adjusts the input volume.
INPUT MUTE	OFF , ON	Turns the mute function on/off. If this is "ON," the input audio is temporarily silenced.
MONO	OFF	Sends the stereo input audio without change.
	L ONLY	The audio of the L channel is sent to both L and R.
	R ONLY	The audio of the R channel is sent to both L and R.
	LR MIX	The audio of the L channel and R channel is mixed, and sent to both L and R.
SOLO	OFF , ON	Turns the solo function on/off. Only the audio for which this is "ON" is heard in the headphones. * The solo function applies to the headphone output. It does not affect output other than the headphones.
EFFECT PRESET	Specifies an effect preset (high-pass filter, compressor, equalizer). * When you change a preset, the settings of each effect are overwritten.	
	DEFAULT	For line input (default setting)
	MEETING	For meetings
	INTERVIEW	For interviews
	WINDY FIELD	For capturing ambient sound in a windy area
DELAY	0.0 -500.0msec (0 -29.9f/25.0f)	Adjusts the delay time of the audio. Effect Outputs audio with a delay.
REVERB SEND	0 -127	Adjusts the amount of audio sent to reverb. Effect This adds reverberation to the sound.
HIGH PASS FILTER 80Hz	OFF , ON	Turns the high-pass filter on/off. Effect Cuts off unneeded low-band audio. The cutoff frequency is 80 Hz.
NOISE GATE	OFF , ON	Turns the noise gate on/off. Effect Mutes audio that is below a specified level.
THRESHOLD	-80-- 48 -0dB	Specifies the level used as the threshold for removing audio. Audio below the level set here is removed.

Menu item	Value (bold text: default value)	Explanation
RELEASE	30– 500 –5000ms	Adjusts the length of time until the audio is fully attenuated after audio falls below the threshold.
COMPRESSOR	OFF , ON	Turns the compressor on/off. Effect This compresses audio that exceeds a specified level.
THRESHOLD	-80– -8 -0dB	Specifies the level used as the threshold at which the compressor is applied. Compression is applied to audio that exceeds the threshold.
RATIO	1.00 : 1, 1.12 : 1, 1.25 : 1, 1.40 : 1, 1.60 : 1, 1.80 : 1, 2.00 : 1, 2.50 : 1 , 3.20 : 1, 4.00 : 1, 5.60 : 1, 8.00 : 1, 16.0 : 1, INF : 1	Specifies the degree of compression applied to the audio. The state in which no compression is applied is defined as "1."
ATTACK	0.0– 30 –100msec	Specifies the time until compression starts when audio exceeding the threshold is input.
RELEASE	30– 250 –5000msec	Adjusts the length of time until compression ends after audio falls below the threshold.
MAKEUP GAIN	-40– 0 –40dB	Adjusts the final output volume level after applying the compressor.
EQUALIZER	OFF , ON	Turns the equalizer on/off. Effect Adjusts the sound quality for each frequency band.
Hi GAIN	-12.0– 0.0 –12.0dB	Boosts or attenuates the high band.
Hi FREQUENCY	1.0– 10.0 –20.0kHz	Adjusts the center frequency when changing the tone quality in the high band.
Mid GAIN	-12.0– 0.0 –12.0dB	Boosts or attenuates the middle band.
Mid FREQUENCY	20.0Hz– 2.00kHz –20.0kHz	Adjusts the center frequency when changing the tone quality in the middle band.
Mid Q	0.5– 1.0 –16.0	Adjusts the width of the frequency band when boosting or attenuating the middle band.
Lo GAIN	-12.0– 0.0 –12.0dB	Boosts or attenuates the low band.
Lo FREQUENCY	20.0Hz– 100Hz –2.00kHz	Adjusts the center frequency when changing the tone quality in the low band.
HDMI IN 1, 2	Adjusts the audio that is input from the HDMI IN 1, 2 connector.	
INPUT LEVEL	-INF– 0.0 –10.0dB	Adjusts the input volume.
INPUT MUTE	OFF , ON	Turns the mute function on/off. If this is "ON," the input audio is temporarily silenced.
MONO	OFF	Sends the stereo input audio without change.
	L ONLY	The audio of the L channel is sent to both L and R.
	R ONLY	The audio of the R channel is sent to both L and R.
	LR MIX	The audio of the L channel and R channel is mixed, and sent to both L and R.
SOLO	OFF , ON	Turns the solo function on/off. Only the audio for which this is "ON" is heard in the headphones. * The solo function applies to the headphone output. It does not affect output other than the headphones.
EFFECT PRESET	Specifies an effect preset (high-pass filter, compressor, equalizer). * When you change a preset, the settings of each effect are overwritten.	
	DEFAULT	For line input (default setting)
	MEETING	For meetings
	INTERVIEW	For interviews
	WINDY FIELD	For capturing ambient sound in a windy area
DELAY	0.0 –500.0msec (0 –29.9f/25.0f)	Adjusts the delay time of the audio. Effect Outputs audio with a delay.
REVERB SEND	0 –127	Adjusts the amount of audio sent to reverb. Effect This adds reverberation to the sound.
HIGH PASS FILTER 80Hz	OFF , ON	Turns the high-pass filter on/off. Effect Cuts off unneeded low-band audio. The cutoff frequency is 80 Hz.
NOISE GATE	OFF , ON	Turns the noise gate on/off. Effect Mutes audio that is below a specified level.
THRESHOLD	-80– -48 -0dB	Specifies the level used as the threshold for removing audio. Audio below the level set here is removed.
RELEASE	30– 500 –5000ms	Adjusts the length of time until the audio is fully attenuated after audio falls below the threshold.
COMPRESSOR	OFF , ON	Turns the compressor on/off. Effect This compresses audio that exceeds a specified level.
THRESHOLD	-80– -8 -0dB	Specifies the level used as the threshold at which the compressor is applied. Compression is applied to audio that exceeds the threshold.
RATIO	1.00 : 1, 1.12 : 1, 1.25 : 1, 1.40 : 1, 1.60 : 1, 1.80 : 1, 2.00 : 1, 2.50 : 1 , 3.20 : 1, 4.00 : 1, 5.60 : 1, 8.00 : 1, 16.0 : 1, INF : 1	Specifies the degree of compression applied to the audio. The state in which no compression is applied is defined as "1."

Menu item	Value (bold text: default value)	Explanation
ATTACK	0.0– 30 –100msec	Specifies the time until compression starts when audio exceeding the threshold is input.
RELEASE	30– 250 –5000msec	Adjusts the length of time until compression ends after audio falls below the threshold.
MAKEUP GAIN	-40– 0 –40dB	Adjusts the final output volume level after applying the compressor.
EQUALIZER	OFF , ON	Turns the equalizer on/off. Effect Adjusts the sound quality for each frequency band.
Hi GAIN	-12.0– 0.0 –12.0dB	Boosts or attenuates the high band.
Hi FREQUENCY	1.0– 10.0 –20.0kHz	Adjusts the center frequency when changing the tone quality in the high band.
Mid GAIN	-12.0– 0.0 –12.0dB	Boosts or attenuates the middle band.
Mid FREQUENCY	20.0Hz– 2.00kHz –20.0kHz	Adjusts the center frequency when changing the tone quality in the middle band.
Mid Q	0.5– 1.0 –16.0	Adjusts the width of the frequency band when boosting or attenuating the middle band.
Lo GAIN	-12.0– 0.0 –12.0dB	Boosts or attenuates the low band.
Lo FREQUENCY	20.0Hz– 100Hz –2.00kHz	Adjusts the center frequency when changing the tone quality in the low band.

9: AUDIO OUTPUT

Menu item	Value (bold text: default value)	Explanation
OUTPUT ASSIGN	These parameters switch the audio output from each jack.	
PHONES OUT	MASTER OUTPUT	Output the audio of the MAIN bus.
	AUX	Output the audio of the AUX bus.
USB OUT	MASTER OUTPUT	Output the audio of the MAIN bus.
	AUX	Output the audio of the AUX bus.
HDMI OUT PROGRAM	MASTER OUTPUT	Output the audio of the MAIN bus.
	AUX	Output the audio of the AUX bus.
HDMI OUT PREVIEW	MASTER OUTPUT	Output the audio of the MAIN bus.
	AUX	Output the audio of the AUX bus.
MASTER OUTPUT	Specifies the main bus.	
MASTER OUTPUT LEVEL	-INF– 0.0 –10.0dB	Adjusts the output volume.
OUTPUT MUTE	OFF , ON	Turns the mute function on/off. If this is “ON,” the output audio is temporarily silenced.
OUTPUT DELAY	0.0 –500.0msec (0 –29.9f/25.0f)	Adjusts the delay time of the audio. Effect Outputs audio with a delay.
LIMITER	OFF , ON	Turns the limiter on/off. Effect Limits the output volume so that it does not exceed the set level.
THRESHOLD	-40– -6 –0dB	Adjusts the level that becomes the threshold at which the limiter is applied. Compression is applied to audio that exceeds the threshold. The volume level of audio that is output is limited so as to stay to below the threshold.
REVERB	OFF , ON	Turns the reverb on/off. Effect This adds reverberation to the sound.
LEVEL	0 –127	Specifies the amount of sound that is returned from the reverb (return level). This adjusts the depth of the overall reverb.
TYPE	ROOM , HALL	Specifies the reverb type. ROOM: Produces the natural-sounding reverberation of a room. HALL: Produces the reverberation that is typical of a performance in a concert hall.
SIZE	1– 10 –20	Specifies the size of the room. The larger the value, the longer the reverb time.
EQUALIZER	OFF , ON	Turns the equalizer on/off. Effect Adjusts the sound quality for each frequency band.
Hi GAIN	-12.0– 0.0 –12.0dB	Boosts or attenuates the high band.
Hi FREQUENCY	1.0– 10.0 –20.0kHz	Adjusts the center frequency when changing the tone quality in the high band.
Mid GAIN	-12.0– 0.0 –12.0dB	Boosts or attenuates the middle band.
Mid FREQUENCY	20.0Hz– 2.00kHz –20.0kHz	Adjusts the center frequency when changing the tone quality in the middle band.
Mid Q	0.5– 1.0 –16.0	Adjusts the width of the frequency band when boosting or attenuating the middle band.
Lo GAIN	-12.0– 0.0 –12.0dB	Boosts or attenuates the low band.
Lo FREQUENCY	20.0Hz– 100Hz –2.00kHz	Adjusts the center frequency when changing the tone quality in the low band.
MULTI BAND COMPRESSOR	OFF , ON	Turns the multi-band compressor on/off. Effect Applies separate compressors in individual frequency band
Hi THRESHOLD	-40– -20 –0dB	Specifies the threshold level at which the compressor is applied to the high band. Compression is applied to audio that exceeds the threshold.

Menu item	Value (bold text: default value)	Explanation
Hi RATIO	1.00 : 1, 1.12 : 1, 1.25 : 1, 1.40 : 1, 1.60 : 1, 1.80 : 1, 2.00 : 1, 2.50 : 1 , 3.20 : 1, 4.00 : 1, 5.60 : 1, 8.00 : 1, 16.0 : 1, INF : 1	Specifies the amount of compression applied in the high band. The state in which no compression is applied is defined as "1."
Mid THRESHOLD	-40-- 16 -0dB	Specifies the threshold level at which the compressor is applied to the middle band. Compression is applied to audio that exceeds the threshold.
Mid RATIO	1.00 : 1, 1.12 : 1, 1.25 : 1, 1.40 : 1, 1.60 : 1, 1.80 : 1, 2.00 : 1, 2.50 : 1 , 3.20 : 1, 4.00 : 1, 5.60 : 1, 8.00 : 1, 16.0 : 1, INF : 1	Specifies the amount of compression applied in the middle band. The state in which no compression is applied is defined as "1."
Lo THRESHOLD	-40-- 20 -0dB	Specifies the threshold level at which the compressor is applied to the low band. Compression is applied to audio that exceeds the threshold.
Lo RATIO	1.00 : 1, 1.12 : 1, 1.25 : 1, 1.40 : 1, 1.60 : 1, 1.80 : 1, 2.00 : 1, 2.50 : 1, 3.20 : 1 , 4.00 : 1, 5.60 : 1, 8.00 : 1, 16.0 : 1, INF : 1	Specifies the amount of compression applied in the low band. The state in which no compression is applied is defined as "1."
AUX	Specifies the AUX bus.	
AUX LEVEL	-INF- 0.0 -10.0dB	Adjusts the output volume.
AUX MUTE	OFF , ON	Turns the mute function on/off. If this is "ON," the output audio is temporarily silenced.
AUX DELAY	0.0 -500.0msec (0 -29.9f/25.0f)	Adjusts the delay time of the audio. Effect Outputs audio with a delay.
LIMITER	OFF , ON	Turns the limiter on/off. Effect Limits the output volume so that it does not exceed the set level.
THRESHOLD	-40-- 6 -0dB	Adjusts the level that becomes the threshold at which the limiter is applied. Compression is applied to audio that exceeds the threshold. The volume level of audio that is output is limited so as to stay to below the threshold.
AUX SEND	(ENTER)	Specifies the type of audio that is sent to the AUX bus.
AUDIO IN 1	-INF , -80-0dB	Sets the amount of input audio signal from the AUDIO IN 1 jack that's sent to the AUX bus.
AUDIO IN 2		Sets the amount of input audio signal from the AUDIO IN 2 jack that's sent to the AUX bus.
USB IN		Sets the amount of input audio signal from the USB IN that's sent to the AUX bus.
HDMI IN 1		Sets the amount of input audio signal from the HDMI IN 1 jack that's sent to the AUX bus.
HDMI IN 2		Sets the amount of input audio signal from the HDMI IN 2 jack that's sent to the AUX bus.
AUX EFFECT	(ENTER)	Specifies the type of audio to send to the AUX bus.
AUDIO IN 1	DRY, PRE FADER , POST FADER	Specifies whether to send the effect-applied audio from each input to the AUX bus. DRY: Sends the source audio with no effects applied. PRE FADER: Sends the effect-applied audio. POST FADER: Sends the effect-applied audio.
AUDIO IN 2		
USB IN		
HDMI IN 1		
HDMI IN 2		
USB OUT	Specifies the USB OUT bus.	
USB OUT LEVEL	-INF- 0.0 -10.0dB	Adjusts the output volume.
USB OUT MUTE	OFF , ON	Turns the mute function on/off. If this is "ON," the output audio is temporarily silenced.
USB OUT DELAY	0.0 -500.0msec (0 -29.9f/25.0f)	Adjusts the delay time of the audio. Effect Outputs audio with a delay.
EQUALIZER	OFF , ON	Turns the equalizer on/off. Effect Adjusts the sound quality for each frequency band.
Hi GAIN	-12.0- 0.0 -12.0dB	Boosts or attenuates the high band.
Hi FREQUENCY	1.0- 10.0 -20.0kHz	Adjusts the center frequency when changing the tone quality in the high band.
Mid GAIN	-12.0- 0.0 -12.0dB	Boosts or attenuates the middle band.
Mid FREQUENCY	20.0Hz- 2.00kHz -20.0kHz	Adjusts the center frequency when changing the tone quality in the middle band.
Mid Q	0.5- 1.0 -16.0	Adjusts the width of the frequency band when boosting or attenuating the middle band.
Lo GAIN	-12.0- 0.0 -12.0dB	Boosts or attenuates the low band.
Lo FREQUENCY	20.0Hz- 100Hz -2.00kHz	Adjusts the center frequency when changing the tone quality in the low band.

10: AUDIO FOLLOW

Menu item	Value (bold text: default value)	Explanation
HDMI IN 1	OFF, ON	Turns the audio follow function on/off. Audio follow is a function that automatically switches the audio output in tandem with video switching.
HDMI IN 2	OFF, ON	If this is "ON," only the audio of the selected input video is output, and audio of the other input video is automatically muted.
AUDIO IN 1	OFF , INPUT 1, INPUT 2, STILL IMAGE	For the audio of AUDIO IN 1, specify the input video (INPUT 1, 2 or STILL IMAGE) that uses audio follow. The audio from AUDIO IN 1 is output only when the specified input video is selected. Turn this off to always output audio from AUDIO IN 1, regardless of the input video selected.
AUDIO IN 2	OFF , INPUT 1, INPUT 2, STILL IMAGE	For the audio of AUDIO IN 2, specify the input video (INPUT 1, 2 or STILL IMAGE) that uses audio follow. The audio from AUDIO IN 2 is output only when the specified input video is selected. Turn this off to always output audio from AUDIO IN 2, regardless of the input video selected.
USB IN	OFF , INPUT 1, INPUT 2, STILL IMAGE	For the audio of USB IN, specify the input video (INPUT 1, 2 or STILL IMAGE) that uses audio follow. The audio from USB IN is output only when the specified input video is selected. Turn this off to always output audio from USB IN, regardless of the input video selected.

11: PRESET MEMORY

Menu item	Value (bold text: default value)	Explanation
LOAD	MEMORY 1–8	Selects the preset memory to load. Pressing the [VALUE] knob lets you load the preset memory.
SAVE	MEMORY 1–8	Selects a preset memory for saving settings. Pressing the [VALUE] knob lets you save the settings to the preset memory. * The state of the [PHONES] knob (headphone volume) is not saved in preset memory. * The following settings are common to the unit (one set for the entire unit), and therefore are not saved in preset memory. <ul style="list-style-type: none"> • PRESET MEMORY menu • CTL/EXP menu • CAPTURE IMAGE menu • SYSTEM menu
INITIALIZE	MEMORY 1–8	Selects the preset memory to be initialized. Press the [VALUE] knob to initialize the preset memory.
NAME EDIT	MEMORY 1–8 * MEMORY 1–8 shows the name that you specify in NAME EDIT.	Selects the preset memory to be renamed. Press the [VALUE] knob to edit the name.
START UP	Specifies the settings loaded at startup.	
	LAST MEMORY	Restores the state that was in effect immediately before the power was turned off (Last Memory feature). The current settings (Last Memory values) are saved every 4 seconds, and when you exit a menu.
	MEMORY 1–8	Recall the settings at the selected memory number.
MEMORY PROTECT	OFF , ON	If this is "ON," the preset memories are protected, and settings cannot be saved to them.
FADE TIME	0.0 –4.0sec	Specifies the fade-in time for the inset screen when recalling a memory that includes a PinP composite.
LOAD PARAMETER	Specifies whether to recall the following items when recalling a preset memory. Items that are turned off are excluded from the preset memories that are recalled.	
VIDEO INPUT	OFF, ON	VIDEO INPUT menu
VIDEO OUTPUT	OFF, ON	VIDEO OUTPUT menu
TRANSITION TIME	OFF, ON	TRANSITION TIME menu
MIX/WIPE/PinP/KEY	OFF, ON	MIX/WIPE/PinP/KEY menu
VIDEO FADER (*13)	INITIALIZE, ON	Video fader position When set to "INITIALIZE," the video fader position is recalled when the video fader is pushed all the way up or pulled all the way down.
VFX	OFF, ON	VFX menu
AUDIO INPUT	OFF, ON	AUDIO INPUT menu
AUDIO OUTPUT	OFF, ON	AUDIO OUTPUT menu
AUDIO FOLLOW	OFF, ON	AUDIO FOLLOW menu

(*13) This is valid when "MIX/WIPE/PinP/KEY" is set to "ON."

12: CTL/EXP

Menu item	Value (bold text: default value)	Explanation
CTL/EXP TYPE	Specifies the device (footswitch, expression pedal) that is connected to the CTL/EXP jack.	
	OFF	Disables the CTL/EXP jack.
	CTL A & CTL B	Choose this if a footswitch is connected.
	EXP	Choose this if an expression pedal is connected.
CTL A ASSIGN CATEGORY (*14) CTL A ASSIGN VALUE (*14) CTL B ASSIGN CATEGORY (*14) CTL B ASSIGN VALUE (*14)	Specifies the functions that are assigned to CTL A and CTL B of the footswitch.	
	N/A	No function is assigned.
	SW CONTROL	-
	INPUT 1 SW	Presses the [1] button.
	INPUT 2 SW	Presses the [2] button.
	EFFECT TYPE SW	Presses the [TYPE] button.
	VFX SW	Turns the [VFX] button on/off.
	TAKE	-
	← AUTO TAKE →	Switches the video between INPUT 1 and 2.
	← CUT →	Switches the video between INPUT 1 and 2 as a cut.
	EFFECTS	
	MIX	Switches the video effect to mix (MIX).
	WIPE	Switches the video effect to wipe (WIPE).
	PinP	Switches the video effect to Picture in Picture (PinP).
	KEY	Switches the video effect to key (KEY).
	STILL IMAGE	Switches between still image output and normal output.
	AUDIO INPUT MUTE	-
	AUDIO IN 1	Turns the mute function on/off for AUDIO IN 1.
	AUDIO IN 2	Turns the mute function on/off for AUDIO IN 2.
	USB IN	Turns the mute function on/off for USB IN.
	HDMI IN 1	Turns the mute function on/off for HDMI IN 1.
	HDMI IN 2	Turns the mute function on/off for HDMI IN 2.
	AUDIO OUTPUT MUTE	-
	MASTER OUTPUT	Turns the mute function on/off for MASTER OUTPUT.
	AUX	Turns the mute function on/off for AUX.
	USB OUT	Turns the mute function on/off for USB OUT.
	AUDIO INPUT SOLO	-
	AUDIO IN 1	Turns the solo function on/off for AUDIO IN 1.
	AUDIO IN 2	Turns the solo function on/off for AUDIO IN 2.
	USB IN	Turns the solo function on/off for USB IN.
	HDMI IN 1	Turns the solo function on/off for HDMI IN 1.
	HDMI IN 2	Turns the solo function on/off for HDMI IN 2.
	VOICE CHANGER SW	-
	AUDIO IN 1	Turns the voice changer function on/off for AUDIO IN 1.
	AUDIO IN 2	Turns the voice changer function on/off for AUDIO IN 2.
	REVERB(MOMENTARY)	Reverb turns on only while you press the footswitch.
	REVERB(ALTERNATE)	Turns the reverb function on/off.
	OUTPUT FADE	-
	LEFT	Switches the [OUTPUT FADE] knob position (center / turned fully counter-clockwise).
	RIGHT	Switches the [OUTPUT FADE] knob position (center / turned fully clockwise).
	LOAD MEMORY	-
	MEMORY 1-8	Recalls MEMORY 1-8.
	MEMORY SCAN	-
	NORMAL	Consecutively switches the preset memory in the order of 1 → 8 each time you press.
	REVERSE	Consecutively switches the preset memory in the order of 8 → 1 each time you press.

Menu item	Value (bold text: default value)	Explanation
EXP ASSIGN CATEGORY (*15) EXP ASSIGN VALUE (*15)		Specifies the function that is assigned to the expression pedal.
	N/A	No function is assigned.
	VIDEO FADER	-
	FADE	Slides the video fader to the left edge or right edge.
	← CUT →	Switches (cuts) between the video being input to INPUT 1 and 2.
	VFX MIX LEVEL	Adjusts the density (output level) of the video that is processed by the visual effect.
	OUTPUT FADE	-
	LEFT	Turns the [OUTPUT FADE] knob counterclockwise.
	RIGHT	Turns the [OUTPUT FADE] knob clockwise.
	STILL IMAGE	Switches between still image output and normal output.
	AUDIO LEVEL	-
	AUDIO IN 1	Adjusts the volume of AUDIO IN 1.
	AUDIO IN 2	Adjusts the volume of AUDIO IN 2.
	USB IN	Adjusts the volume of USB IN.
	HDMI IN 1	Adjusts the volume of HDMI IN 1.
	HDMI IN 2	Adjusts the volume of HDMI IN 2.
	MASTER OUTPUT	Adjusts the MASTER OUTPUT volume.
	AUX	Adjusts the AUX volume.
	USB OUT	Adjusts the USB OUT volume.
	VOICE CHANGER	-
	AUDIO IN 1 PITCH	Adjusts the pitch of AUDIO IN 1.
	AUDIO IN 1 FORMANT	Adjusts the formant of AUDIO IN 1.
	AUDIO IN 1 MIX	Adjusts the mix of AUDIO IN 1.
AUDIO IN 2 PITCH	Adjusts the pitch of AUDIO IN 2.	
AUDIO IN 2 FORMANT	Adjusts the formant of AUDIO IN 2.	
AUDIO IN 2 MIX	Adjusts the mix of AUDIO IN 2.	
REVERB LEVEL	Adjusts the reverb level.	
EXP CALIBRATE (*15)	(ENTER)	Displays the EXP CALIBRATE screen. Following the direction on the screen, calibrate (adjust) the expression pedal. The first time you use the expression pedal, be sure to execute calibration so that the pedal will operate optimally. In some cases, the expression pedal might no longer be operating optimally because of the passage of time or the conditions of use. In such cases you should also execute expression pedal calibration.

(*14) This is valid when "CTL/EXP TYPE" is set to "CTL A & CTL B."

(*15) This is valid when "CTL/EXP TYPE" is set to "EXP."

13: CAPTURE IMAGE

Menu item	Value (bold text: default value)	Explanation
CAPTURE SOURCE	INPUT 1 , INPUT 2	Specifies the input video from which to capture the still image.
CAPTURE EXECUTE	(EXEC)	Capture a still image from the input video.
SHORTCUT (INPUT SW)	DISABLE , ENABLE (*16)	Specifies whether still image capture by operating a button (long-pressing the [1] or [2] button) is enabled (ENABLE) or disabled (DISABLE).
SAVE TO INTERNAL STORAGE	Specifies how the captured still image is saved. * The unit can only save one still image (including temporary saving). If a still image is already saved, it is overwritten when you execute a new capture.	
	DISABLE	The still image is captured at the actual resolution and temporarily saved in the unit. When you turn off the power, the captured still image is deleted. This allows the image to be captured without impairing the image quality. It is suitable for still images that include a logo or small characters.
	ENABLE	The still image is captured at a reduced resolution of 640 x 360 and saved in the unit. Since the still image is expanded when it is output, the image quality might be impaired.
DELETE STILL IMAGE	(EXEC)	Deletes the still image that is saved in the unit.
	---	Indicates that no still image is saved in the unit.

(*16) Even if this is set to "ENABLE," you cannot capture a still image by operating the [1] or [2] button if the SYSTEM menu item "INPUT 1 SW ASSIGN" is set to "← TRANSFORM" or if "INPUT 2 SW ASSIGN" is set to "TRANSFORM →."

14: SYSTEM

Menu item	Value (bold text: default value)	Explanation
HDCP	OFF , ON	Specifies whether HDCP is enabled (ON) or disabled (OFF). When set to "ON," copyright-protected (HDCP) video can be input. HDCP is also added to the video that is output. * A change in the setting is not applied until you press the [VALUE] knob to confirm.
FRAME RATE	59.94, 50Hz	Specifies the frame rate. * A change in the setting is not applied until you press the [VALUE] knob to confirm.
INPUT 1 SW ASSIGN (*17) INPUT 2 SW ASSIGN (*17)	Specify the functions that are assigned to the [1] [2] buttons.	
	← AUTO TAKE (INPUT 1 only) AUTO TAKE → (INPUT 2 only)	The video switches when you press the button to select the input image. The transition time is specified by the TRANSITION menu item "TRANSITION TIME."
	← AUTO TAKE →	The INPUT 1 and 2 video is switched each time you press the button. The transition time is specified by the TRANSITION menu item "TRANSITION TIME."
	← CUT (INPUT 1 only) CUT → (INPUT 2 only)	The video is switched as a cut when you press the button to select the input video.
	← CUT →	The video of INPUT 1 and 2 is switched as a cut each time you press the button.
	← TRANSFORM (INPUT 1 only) TRANSFORM → (INPUT 2 only)	The video is switched as a cut only while the button is held down to select the input video. When you release the button, you return to the program output video.
OUTPUT FADE ASSIGN	Specify the functions when turning the [OUTPUT FADE] knob counter-clockwise (TURN LEFT) or clockwise (TURN RIGHT).	
TURN LEFT TURN RIGHT	BLACK	The program output video is faded-in/out to a black screen.
	WHITE	The program output video is faded-in/out to a white screen.
	STILL IMAGE	When the [OUTPUT FADE] knob is turned all the way, the captured still image is output as a cut to program/preview output. This is the default setting for "TURN RIGHT."
	CONTRAST	Adjusts the contrast of the program output video.
	AUDIO	Adjusts the output volume.
	BLACK&AUDIO	Fades-in/out the program output video and audio simultaneously. The video fades to a black screen. This is the default setting for "TURN LEFT."
	WHITE&AUDIO	Fades-in/out the program output video and audio simultaneously. The video fades to a white screen.
STILL IMAGE&AUDIO	Adjusts the output volume. When the [OUTPUT FADE] knob is turned all the way, the captured still image is output as a cut to preview/program output.	

(*17) This is valid when mix/wipe is selected as the video effect.

Menu item	Value (bold text: default value)	Explanation	
AUDIO FX ASSIGN	You can configure the parameters to adjust by turning the [CONTROL 1] and [CONTROL 2] knobs while holding down the [VFX] button.		
CTR 1 CTR 2	AUDIO IN 1 ANALOG GAIN	Adjusts the analog gain of AUDIO IN 1.	
	AUDIO IN 1 LEVEL	Adjusts the input level of AUDIO IN 1.	
	AUDIO IN 1 DELAY	Adjusts the delay time of AUDIO IN 1.	
	AUDIO IN 1 REVERB SEND	Adjusts the reverb send of AUDIO IN 1.	
	AUDIO IN 1 VOICE PITCH	Adjusts the voice changer pitch of AUDIO IN 1.	
	AUDIO IN 1 VOICE FORMANT	Adjusts the voice changer formant of AUDIO IN 1.	
	AUDIO IN 1 VOICE MIX	Adjusts the voice changer mix of AUDIO IN 1.	
	AUDIO IN 2 ANALOG GAIN	Adjusts the analog gain of AUDIO IN 2.	
	AUDIO IN 2 LEVEL	Adjusts the input level of AUDIO IN 2.	
	AUDIO IN 2 DELAY	Adjusts the delay time of AUDIO IN 2.	
	AUDIO IN 2 REVERB SEND	Adjusts the reverb send of AUDIO IN 2.	
	AUDIO IN 2 VOICE PITCH	Adjusts the voice changer pitch of AUDIO IN 2.	
	AUDIO IN 2 VOICE FORMANT	Adjusts the voice changer formant of AUDIO IN 2.	
	AUDIO IN 2 VOICE MIX	Adjusts the voice changer mix of AUDIO IN 2.	
	USB IN LEVEL	Adjusts the input level of USB IN.	
	USB IN DELAY	Adjusts the delay time of USB IN.	
	USB IN REVERB SEND	Adjusts the reverb send of USB IN.	
	HDMI IN 1 LEVEL	Adjusts the input level of HDMI IN 1.	
	HDMI IN 1 DELAY	Adjusts the delay time of HDMI IN 1.	
	HDMI IN 1 REVERB SEND	Adjusts the reverb send of HDMI IN 1.	
	HDMI IN 2 LEVEL	Adjusts the input level of HDMI IN 2.	
	HDMI IN 2 DELAY	Adjusts the delay time of HDMI IN 2.	
	HDMI IN 2 REVERB SEND	Adjusts the reverb send of HDMI IN 2.	
	MASTER OUTPUT LEVEL	Adjusts the output volume of Main bus.	
AUX OUT LEVEL	Adjusts the output volume of AUX bus.		
USB OUT LEVEL	Adjusts the output volume of USB OUT bus.		
USB OUT DELAY	Adjusts the delay time of USB OUT.		
REVERB LEVEL	Adjusts the reverb level.		
(ENTER)	Displays the following PANEL LOCK menu.		
PANEL LOCK	Enable (ON) or disable (OFF) the panel lock.		
	Menu item	Value (bold text: default value)	Explanation
	ALL SW & VOLUME	OFF , ON	The settings of the following buttons and knobs are turned on/off together.
	INPUT 1 SW	OFF , ON	[1] button
	INPUT 2 SW	OFF , ON	[2] button
	VIDEO FADER	OFF , ON	Video fader
	OUTPUT FADE	OFF , ON	[OUTPUT FADE] knob
	VFX SW	OFF , ON	[VFX] button
	EFFECT TYPE SW	OFF , ON	[TYPE] button
	CONTROL 1 ENCODER	OFF , ON	[CONTROL 1] knob
CONTROL 2 ENCODER	OFF , ON	[CONTROL 2] knob	

Menu item	Value (bold text: default value)	Explanation	
LED ASSIGN	(ENTER)	Displays the following LED ASSIGN menu.	
	Specify the button illumination color, and the lit/unlit state of the buttons and indicators.		
	Menu item	Value (bold text: default value)	Explanation
	Specify the illumination color of the [1] [2] buttons.		
	PROGRAM LED COLOR		During program output (default: RED)
	PREVIEW LED COLOR	RED, GREEN, YELLOW, BLUE, MAGENTA, CYAN, WHITE, OFF	During preview output (default: GREEN)
	BG SELECT COLOR		When selected as the background video for video compositing (default: YELLOW)
	Specify the lit (ON) or unlit (OFF) status of the buttons and indicators.		
	ALL LED	OFF, ON	The settings of the following buttons and knobs are turned on/off together.
	INPUT 1 LED	OFF, ON	[1] button
	INPUT 2 LED	OFF, ON	[2] button
	VIDEO FADER LED	OFF, ON	Transition indicators
	MENU LED	OFF, ON	[MENU] button
	VFX LED	OFF, ON	[VFX] button
	EFFECTS LED	OFF, ON	MIX/WIPE/PinP/KEY indicators
OUTPUT FADE LEFT LED	OFF, ON	Indicator at the left side of the [OUTPUT FADE] knob	
OUTPUT FADE RIGHT LED	OFF, ON	Indicator at the right side of the [OUTPUT FADE] knob	
EFFECT TYPE SW ASSIGN	(ENTER)	Displays the following EFFECT TYPE SW ASSIGN menu.	
	Enables (ENABLE) or disables (DISABLE) the video effect. If this is set to "DISABLE," the effect cannot be selected by the [TYPE] button.		
	Menu item	Value (bold text: default value)	Explanation
	MIX	DISABLE, ENABLE	Switching effect: mix
	WIPE	DISABLE, ENABLE	Switching effect: wipe
	PinP	DISABLE, ENABLE	Compositing effect: picture in picture
KEY	DISABLE, ENABLE	Compositing effect: key	
PREVIEW LABEL	OFF, ON	If this is "ON," a PREVIEW label is shown on the preview display.	
AUDIO LEVEL METER	OFF, ON	If this is "ON," an audio level meter is shown on the preview display.	
AUTO SWITCHING	OFF , ON	Turns on/off the function that automatically switches the input video.	
TYPE	INPUT SCAN , PRESET MEMORY SCAN	Specifies the AUTO SWITCHING type.	
TIME	(ENTER)	Specifies the time (seconds) at which the video is automatically switched.	
	When TYPE is "INPUT SCAN"		
	Menu item	Value (bold text: default value)	Explanation
	INPUT 1 TIME	OFF, 5 –120sec	Specifies the time during which the video is shown. If this is "OFF," video switching does not apply to this input.
	INPUT 2 TIME		
	SCAN TRANSITION TIME	0.0– 1.0 –4.0sec	Specifies the scan transition time.
	When TYPE is "PRESET MEMORY SCAN"		
	Menu item	Value (bold text: default value)	Explanation
	MEMORY 1–8 TIME	OFF, 1– 5 –120sec	Specifies the time during which the memory is shown. If this is "OFF," video switching does not use this memory.
	SEQUENCE	NORMAL , REVERSE, RANDOM	Specifies the scan sequence (only when TYPE is PRESET MEMORY SCAN).
TEST PATTERN	Specifies the test pattern.		
PATTERN	OFF , 75% COLOR BAR, 100% COLOR BAR, RAMP, STEP, HATCH	Selects the type of test pattern.	
MOTION	DISABLE , SLOW, FAST	Sets the scroll speed of the test pattern.	
TEST TONE	Specifies the test tone.		
LEVEL	OFF , -20dB, -10dB, 0dB	Specifies the volume level of the test tone.	
FREQUENCY L	500Hz, 1kHz , 2kHz	Specifies the frequency of the test tone for the L-channel.	
FREQUENCY R	500Hz, 1kHz , 2kHz	Specifies the frequency of the test tone for the R-channel.	
AUTO INPUT DETECT	OFF, ON	Turns the auto input detect function on/off. If this is "ON," and the video that is being output as the program disappears, the program automatically switches to the other input video.	
AUTO OFF	OFF, ON	Turns the Auto Off function on/off. If this is "ON," the power to the V-02HD MK II turns off automatically when all of the following states persist for 240 minutes. <ul style="list-style-type: none"> No operation performed on the V-02HD MK II No audio or video input No equipment is connected to the PROGRAM OUT/PREVIEW OUT connectors 	

Menu item	Value (bold text: default value)	Explanation
VIDEO FADER CALIBRATE	(ENTER)	Displays the VIDEO FADER SET screen. Following the instructions on the screen, calibrate (adjust) the video fader. In some cases, because of continued use or transport, the video output might not reach 100% even if you slide the video fader all the way to the left or right. Execute video fader calibration in this case as well.
OUTPUT FADE CALIBRATE	(ENTER)	Displays the OUTPUT FADER SET screen. Following the instructions on the screen, calibrate (adjust) the output fader.
FACTORY RESET	(EXEC)	Returns the unit to its factory defaults.
VERSION	—	Displays the version of the system program.

Shortcut List

You can set the following items without entering a menu.

Menu item	Operation
WINDOW POSITION H	Turn the [CONTROL 1] knob (EFFECT = PinP)
WINDOW SIZE	Turn the [CONTROL 1] knob while pressing it (EFFECT = PinP)
WINDOW POSITION V	Turn the [CONTROL 2] knob (EFFECT = PinP)
VIEW ZOOM	Turn the [CONTROL 2] knob while pressing it (EFFECT = PinP)
KEY LEVEL	Turn the [CONTROL 1] knob (EFFECT = KEY)
KEY GAIN	Turn the [CONTROL 2] knob (EFFECT = KEY)

MIDI Implementation

Model: V-02HD MKII
Date: June 17, 2021
Version: 1.00

Symbol	Item	Setting Range
n	MIDI Channel	Fixed at 00H

1. MIDI Messages Received at MIDI IN

Channel Voice Messages

Control Change

General Purpose Controllers 1 (Controller Number 10)

This control the position of video fader.

Status	2nd Byte	3rd Byte
BnH	0AH	vvH

vv = 00H–7FH (00H: far left, 7FH: far right)

General Purpose Controllers 2 (Controller Number 11)

This control the value of EFFECTS TYPE.

Status	2nd Byte	3rd Byte
BnH	0BH	vvH

vv = 00H–03H (MIX, WIPE, PinP, KEY)

General Purpose Controllers 3 (Controller Number 12)

This control the value of MIX/WIPE TIME.

Status	2nd Byte	3rd Byte
BnH	0CH	vvH

vv = 00H–28H (0.0–4.0sec)

General Purpose Controllers 4 (Controller Number 13)

This control the value of PinP TIME.

Status	2nd Byte	3rd Byte
BnH	0DH	vvH

vv = 00H–28H (0.0–4.0sec)

Undefined (Controller Number 14)

This control the value of KEY TIME.

Status	2nd Byte	3rd Byte
BnH	0EH	vvH

vv = 00H–28H (0.0–4.0sec)

Undefined (Controller Number 15)

This control the value of PinP POSITION H.

Status	2nd Byte	3rd Byte
BnH	0FH	vvH

vv = 00H–64H (-50–50%)

General Purpose Controllers 1 (Controller Number 16)

This control the value of PinP POSITION V.

Status	2nd Byte	3rd Byte
BnH	10H	vvH

vv = 00H–64H (-50–50%)

General Purpose Controllers 2 (Controller Number 17)

This control the value of PinP SIZE.

Status	2nd Byte	3rd Byte
BnH	11H	vvH

vv = 0AH–64H (10–100%)

General Purpose Controllers 3 (Controller Number 18)

This control the value of PinP VIEW ZOOM.

Status	2nd Byte	3rd Byte
BnH	12H	vvH

vv = 0AH–64H (100–1000%)

General Purpose Controllers 4 (Controller Number 19)

This control the value of KEY SOURCE.

Status	2nd Byte	3rd Byte
BnH	13H	vvH

vv = 00H–02H (INPUT 1, INPUT 2, STILL IMAGE)

Undefined (Controller Number 20)

This control the value of KEY LEVEL.

Status	2nd Byte	3rd Byte
BnH	14H	vvH

vv = 00H–7FH (0–255)

Undefined (Controller Number 21)

This control the value of KEY GAIN.

Status	2nd Byte	3rd Byte
BnH	15H	vvH

vv = 00H–7FH (0–255)

Undefined (Controller Number 22)

This control the value of KEY MIX LEVEL.

Status	2nd Byte	3rd Byte
BnH	16H	vvH

vv = 00H–7FH (0–255)

Undefined (Controller Number 23)

This control the value of VFX SW.

Status	2nd Byte	3rd Byte
BnH	17H	vvH

vv = 00H, 01H (OFF, ON)

○ Undefined (Controller Number 24)

This control the value of VFX TYPE.

Status	2nd Byte	3rd Byte
BnH	18H	vvH

vv = 00H–0FH (PART MOSAIC, BACKGROUND MOSAIC, FULL MOSAIC, WAVE, RGB REPLACE, COLORPASS, NEGATIVE, COLORIZE, POSTERIZE, SILHOUETTE, EMOSS, FIND EDGES, MONOCOLOR, HUE OFFSET, SATURATION OFFSET, VALUE OFFSET)

○ Undefined (Controller Number 25)

This control the value of VFX MIX LEVEL.

Status	2nd Byte	3rd Byte
BnH	19H	vvH

vv = 00H–7FH (0–255)

○ Undefined (Controller Number 26)

This control the [OUTPUT FADE] knob position (counter-clockwise)

Status	2nd Byte	3rd Byte
BnH	1AH	vvH

vv = 00H–3FH

○ Undefined (Controller Number 27)

This control the [OUTPUT FADE] knob position (clockwise)

Status	2nd Byte	3rd Byte
BnH	1BH	vvH

vv = 00H–3FH

○ Undefined (Controller Number 28)

This control the value of AUDIO INPUT LEVEL (INPUT 1).

Status	2nd Byte	3rd Byte
BnH	1CH	vvH

vv = 00H–7FH (0–127)

* For details, refer to the “Input/output level correspondence chart” (p. 58).

○ Undefined (Controller Number 29)

This control the value of AUDIO INPUT LEVEL (INPUT 2).

Status	2nd Byte	3rd Byte
BnH	1DH	vvH

vv = 00H–7FH (0–127)

* For details, refer to the “Input/output level correspondence chart” (p. 58).

○ Undefined (Controller Number 30)

This control the value of AUDIO INPUT LEVEL (AUDIO IN).

Status	2nd Byte	3rd Byte
BnH	1EH	vvH

vv = 00H–7FH (0–127)

* For details, refer to the “Input/output level correspondence chart” (p. 58).

○ Undefined (Controller Number 31)

This control the value of AUDIO OUTPUT LEVEL.

Status	2nd Byte	3rd Byte
BnH	1FH	vvH

vv = 00H–7FH (0–127)

* For details, refer to the “Input/output level correspondence chart” (p. 58).

○ Undefined (Controller Number 52)

Presses the [1] button.

Status	2nd Byte	3rd Byte
BnH	34H	vvH

vv = any (00H–7FH)

○ Undefined (Controller Number 53)

Presses the [2] button.

Status	2nd Byte	3rd Byte
BnH	35H	vvH

vv = any (00H–7FH)

○ Undefined (Controller Number 54)

Switches the video as “◀ AUTO TAKE ▶”.

Status	2nd Byte	3rd Byte
BnH	36H	vvH

vv = any (00H–7FH)

○ Undefined (Controller Number 55)

Switches the video as “◀ CUT ▶”.

Status	2nd Byte	3rd Byte
BnH	37H	vvH

vv = any (00H–7FH)

○ Undefined (Controller Number 56)

Enable still image output.

Status	2nd Byte	3rd Byte
BnH	38H	vvH

vv = 00H, 01H (OFF, ON)

○ Undefined (Controller Number 57)

This control the value of AUDIO INPUT 1 MUTE.

Status	2nd Byte	3rd Byte
BnH	39H	vvH

vv = 00H, 01H (OFF, ON)

○ Undefined (Controller Number 58)

This control the value of AUDIO INPUT 2 MUTE.

Status	2nd Byte	3rd Byte
BnH	3AH	vvH

vv = 00H, 01H (OFF, ON)

○ Undefined (Controller Number 59)

This control the value of AUDIO IN MUTE.

Status	2nd Byte	3rd Byte
BnH	3BH	vvH

vv = 00H, 01H (OFF, ON)

○ Undefined (Controller Number 60)

This control the value of AUDIO OUTPUT MUTE.

Status	2nd Byte	3rd Byte
BnH	3CH	vvH

vv = 00H, 01H (OFF, ON)

Input/output level correspondence chart (unit: dB)

0	-Inf	32	-33.1	64	-11.3	96	-0.3
1	-80.0	33	-32.3	65	-10.7	97	0.0
2	-76.7	34	-31.5	66	-10.3	98	0.3
3	-73.3	35	-30.8	67	-10.0	99	0.7
4	-70.0	36	-30.0	68	-9.7	100	1.0
5	-66.7	37	-29.3	69	-9.3	101	1.3
6	-63.3	38	-28.7	70	-9.0	102	1.7
7	-60.0	39	-28.0	71	-8.7	103	2.0
8	-58.6	40	-27.3	72	-8.3	104	2.3
9	-57.1	41	-26.7	73	-8.0	105	2.7
10	-55.7	42	-26.0	74	-7.7	106	3.0
11	-54.3	43	-25.3	75	-7.3	107	3.3
12	-52.9	44	-24.7	76	-7.0	108	3.7
13	-51.4	45	-24.0	77	-6.7	109	4.0
14	-50.0	46	-23.3	78	-6.3	110	4.3
15	-48.9	47	-22.7	79	-6.0	111	4.7
16	-47.8	48	-22.0	80	-5.7	112	5.0
17	-46.7	49	-21.3	81	-5.3	113	5.3
18	-45.6	50	-20.7	82	-5.0	114	5.7
19	-44.4	51	-20.0	83	-4.7	115	6.0
20	-43.3	52	-19.3	84	-4.3	116	6.3
21	-42.2	53	-18.7	85	-4.0	117	6.7
22	-41.1	54	-18.0	86	-3.7	118	7.0
23	-40.0	55	-17.3	87	-3.3	119	7.3
24	-39.2	56	-16.7	88	-3.0	120	7.7
25	-38.5	57	-16.0	89	-2.7	121	8.0
26	-37.7	58	-15.3	90	-2.3	122	8.3
27	-36.9	59	-14.7	91	-2.0	123	8.7
28	-36.2	60	-14.0	92	-1.7	124	9.0
29	-35.4	61	-13.3	93	-1.3	125	9.3
30	-34.6	62	-12.7	94	-1.0	126	9.7
31	-33.8	63	-12.0	95	-0.7	127	10.0

Program Change

This message recalls a preset memory.

Status	2nd Byte
CnH	ppH

pp = Memory number: 00H–07H (MEMORY 1–MEMORY 8)

System Exclusive Messages

Status	Data Byte	Status
F0H	iiH, ddH, ..., eeH	F7H

F0H: Status of system exclusive message
 ii= ID number: This is the ID to recognize manufacturer of the exclusive message (manufacturer ID). The manufacturer ID of Roland is 41H. The ID numbers of 7EH and 7FH are expansion of MIDI standards and used as universal non-realtime message (7EH) of universal realtime message (7FH).
 dd, ..., ee= data: 00H–7FH (0–127)
 F7H: EOX (end of exclusive)

Data Request 1 (RQ1)

This is the message to request of "send data" to the connected device. Specify data type and amount using address and size. When this is received, the unit sends the requested data as "Data Set 1 (DT1)" message in case the unit is in status where the sending of data is possible and requested address and size are appropriate. If not, the unit sends nothing.

Status	Data Byte	Status
F0H	41H, 10H, 00H, 00H, 54H, 11H, aaH, bbH, ccH, ssH, ttH, uuH, sum	F7H

Byte	Explanation
F0H	Exclusive Status
41H	Manufacturer ID (Roland)
10H	Device ID
00H	1st byte of model ID (V-02HD MKII)
00H	2nd byte of model ID (V-02HD MKII)
00H	3rd byte of model ID (V-02HD MKII)
00H	4th byte of model ID (V-02HD MKII)
0AH	5th byte of model ID (V-02HD MKII)
11H	Command ID (RQ1)
aaH	Address upper byte
bbH	Address middle byte
ccH	Address lower byte
ssH	Size upper byte
ttH	Size middle byte
uuH	Size lower byte
sum	Checksum
F7H	EOX (end of exclusive)

* Depending on the data type, the amount of single-time transmission is specified. It is necessary to execute data request according to the specified first address and size. Refer to the "2. Parameter Address Map" (p. 59) for address and size.

* See "Example of an Exclusive Message and Calculating a Checksum" (p. 68) for checksum.

Data Set 1 (DT1)

This is the message of actual data transmission. Use this when you want to set data to the unit.

Status	Data Byte	Status
F0H	41H, 10H, 00H, 00H, 54H, 12H, aaH, bbH, ccH, ddH, ..., eeH, sum	F7H

Byte	Explanation
F0H	Exclusive Status
41H	Manufacturer ID (Roland)
10H	Device ID
00H	1st byte of model ID (V-02HD MKII)
00H	2nd byte of model ID (V-02HD MKII)
00H	3rd byte of model ID (V-02HD MKII)
00H	4th byte of model ID (V-02HD MKII)
0AH	5th byte of model ID (V-02HD MKII)
12H	Command ID (DT1)
aaH	Address upper byte
bbH	Address middle byte
ccH	Address lower byte
ddH	Data: actual data to transmit. Multiple byte data is sent in address order.
:	:
eeH	Data
sum	Checksum
F7H	EOX (end of exclusive)

* Depending on the data type, the amount of single-time transmission is specified. It is necessary to execute data request according to the specified first address and size. Refer to the "2. Parameter Address Map" (p. 59) for address and size.

* See "Example of an Exclusive Message and Calculating a Checksum" (p. 68) for checksum.

* Data exceeding 256 bytes should be divided into packets of 256 bytes or smaller. If you send data set 1 successively, set interval of 20 ms or longer between packets.

2. Parameter Address Map

Start Address	Description
00H 00H 00H	Video Parameter Area
01H 00H 00H	Audio Parameter Area
02H 00H 00H	System Parameter Area
0AH 00H 00H	Other Parameter Area
10H 00H 00H	Preset Memory Area

● Video Parameter Area

○ Video Input

* "xxH" corresponds to the respective channels as indicated below.

xxH = 00H, 01H (INPUT 1, INPUT 2)

Address	Parameter Name	Sys.Ex.Value	Meaning of Value
00H xxH 00H	FLICKER FILTER	00H-01H	OFF, ON
00H xxH 01H	FLIP H	00H-01H	OFF, ON
00H xxH 02H	FLIP V	00H-01H	OFF, ON
00H xxH 03H	EDID	00H-0BH	INTERNAL, SVGA (800 x 600), XGA (1024 x 768), WXGA (1280 x 800), FWXGA (1366 x 768), SXGA (1280 x 1024), SXGA+ (1400 x 1050), UXGA (1600 x 1200), WUXGA (1920 x 1200), 720p, 1080i, 1080p
00H xxH 04H 05H	ZOOM	00H 64H-4EH 10H	10.0-1000.0%
00H xxH 06H	SCALING TYPE	00H-04H	FULL, LETTERBOX, CROP, DOT BY DOT, MANUAL
00H xxH 07H 08H	MANUAL SIZE H	70H 30H-00H 00H-0FH 50H	-2000-0-2000
00H xxH 09H 0AH	MANUAL SIZE V	70H 30H-00H 00H-0FH 50H	-2000-0-2000
00H xxH 0BH 0CH	POSITION H	71H 00H-00H 00H-0FH 00H	-1920-0-1920
00H xxH 0DH 0EH	POSITION V	76H 50H-00H 00H-09H 30H	-1200-0-1200
00H xxH 0FH	BRIGHTNESS	00H-7FH	-64-63
00H xxH 10H	CONTRAST	00H-7FH	-64-63
00H xxH 11H	SATURATION	00H-7FH	-64-63
00H xxH 12H	RED	00H-7FH	-64-63
00H xxH 13H	GREEN	00H-7FH	-64-63
00H xxH 14H	BLUE	00H-7FH	-64-63
00H xxH 15H	SHARED INPUT (*)	00H-01H	OFF, ON

(*) INPUT 2 only

○ Video Output

* "xxH" corresponds to the respective channels as indicated below.

xxH = 10H, 11H (PROGRAM OUT, PREVIEW OUT)

Address	Parameter Name	Sys.Ex.Value	Meaning of Value
00H xxH 00H	OUTPUT ASSIGN (*1)	00H-01H	PROGRAM, PREVIEW
00H xxH 01H	COLOR SPACE	00H-03H	YCC, RGB (0-255), RGB (16-235)
00H xxH 02H	DVI-D/HDMI SIGNAL	00H-01H	HDMI, DVI-D
00H xxH 03H	BRIGHTNESS	00H-7FH	-64-63
00H xxH 04H	CONTRAST	00H-7FH	-64-63
00H xxH 05H	SATURATION	00H-7FH	-64-63
00H xxH 06H	RED	00H-7FH	-64-63
00H xxH 07H	GREEN	00H-7FH	-64-63
00H xxH 08H	BLUE	00H-7FH	-64-63

(*1) PREVIEW OUT only

○ Scaling

Address	Parameter Name	Sys.Ex.Value	Meaning of Value
00H 12H 00H	OUTPUT FORMAT	00H-0DH	480p/576p, 720p, 1080i, 1080p, SVGA (800 x 600), XGA (1024 x 768), WXGA (1280 x 800), FWXGA (1366 x 768), SXGA (1280 x 1024), SXGA+ (1400 x 1050), UXGA (1600 x 1200), WUXGA (1920 x 1200), HD (1280 x 720), FHD (1920 x 1080)
00H 12H 01H 02H	ZOOM	00H 64H-4EH 10H	10.0-1000.0%
00H 12H 03H 04H	SIZE H	70H 30H-00H 00H-0FH 50H	-2000-0-2000
00H 12H 05H 06H	SIZE V	70H 30H-00H 00H-0FH 50H	-2000-0-2000
00H 12H 07H 08H	POSITION H	71H 00H-00H 00H-0FH 00H	-1920-0-1920
00H 12H 09H 0AH	POSITION V	76H 50H-00H 00H-09H 30H	-1200-0-1200

○ USB OUT

Address	Parameter Name	Sys.Ex.Value	Meaning of Value
00H 13H 00H	USB OUTPUT ASSIGN	00H-01H	PROGRAM, PREVIEW
00H 13H 01H	USB OUTPUT FORMAT	00H-01H	YUY2 & MJPEG, YUY2

○ Transition Time

Address	Parameter Name	Sys.Ex.Value	Meaning of Value
00H 20H 00H	MIX/WIPE TIME	00H-28H	0.0-4.0sec
00H 20H 01H	PinP TIME	00H-28H	0.0-4.0sec
00H 20H 02H	KEY TIME	00H-28H	0.0-4.0sec

○ MIX/WIPE

Address	Parameter Name	Sys.Ex.Value	Meaning of Value
00H 21H 00H	MIX TYPE	00H-02H	MIX, FAM, NAM
00H 21H 01H	WIPE TYPE	00H-08H	HORIZONTAL, VERTICAL, UPPER LEFT, UPPER RIGHT, LOWER LEFT, LOWER RIGHT, H-CENTER, V-CENTER, BOX
00H 21H 02H	WIPE DIRECTION	00H-02H	NORMAL, REVERSE, ROUND TRIP
00H 21H 03H	WIPE BORDER COLOR	00H-08H	WHITE, YELLOW, CYAN, GREEN, MAGENTA, RED, BLUE, BLACK, SOFT EDGE
00H 21H 04H	WIPE BORDER WIDTH	00H-0FH	0-15

○ PinP

Address	Parameter Name	Sys.Ex.Value	Meaning of Value
00H 22H 00H 01H	POSITION H	78H 18H-00H 00H-07H 68H	-100.0-0.0-100.0%
00H 22H 02H 03H	POSITION V	78H 18H-00H 00H-07H 68H	-100.0-0.0-100.0%
00H 22H 04H 05H	SIZE	00H 64H-07H 68H	10.0-100.0%
00H 22H 06H 07H	CROPPING H	00H 00H-07H 68H	0.0-100.0%
00H 22H 08H 09H	CROPPING V	00H 00H-07H 68H	0.0-100.0%
00H 22H 0AH	BORDER COLOR	00H-08H	WHITE, YELLOW, CYAN, GREEN, MAGENTA, RED, BLUE, BLACK, SOFT EDGE
00H 22H 0BH	BORDER WIDTH	00H-0FH	0-15
00H 22H 0CH	SHAPE	00H-02H	RECTANGLE, CIRCLE, DIAMOND
00H 22H 0DH 0EH	VIEW POSITION H	7CH 0CH-00H 00H-03H 74H	-50.0-0.0-50.0%
00H 22H 0FH 10H	VIEW POSITION V	7CH 0CH-00H 00H-03H 74H	-50.0-0.0-50.0%
00H 22H 11H 12H	VIEW ZOOM	00H 64H-4EH 10H	100-1000%
00H 22H 13H	PROGRAM OUT MODE	00H-01H	OFF, ON

○ KEY

Address	Parameter Name	Sys.Ex.Value	Meaning of Value
00H 23H 00H	KEY SOURCE	00H-02H	INPUT 1, INPUT 2, STILL IMAGE
00H 23H 01H	KEY TYPE	00H-02H	LUMINANCE-WHITE, LUMINANCE-BLACK, CHROMA
00H 23H 02H 03H	KEY LEVEL	00H 00H-01H 7FH	0-255
00H 23H 04H 05H	KEY GAIN	00H 00H-01H 7FH	0-255
00H 23H 06H 07H	MIX LEVEL	00H 00H-01H 7FH	0-255
00H 23H 08H 09H	POSITION H	78H 18H-00H 00H-07H 68H	-100.0-0.0-100.0%
00H 23H 0AH 0BH	POSITION V	78H 18H-00H 00H-07H 68H	-100.0-0.0-100.0%
00H 23H 0CH 0DH	SIZE	00H 64H-07H 68H	10.0-100.0%
00H 23H 0EH 0FH	CROPPING H	00H 00H-07H 68H	0.0-100.0%
00H 23H 10H 11H	CROPPING V	00H 00H-07H 68H	0.0-100.0%
00H 23H 12H 13H	VIEW POSITION H	7CH 0CH-00H 00H-03H 74H	-50.0-0.0-50.0%
00H 23H 14H 15H	VIEW POSITION V	7CH 0CH-00H 00H-03H 74H	-50.0-0.0-50.0%
00H 23H 16H 17H	VIEW ZOOM	00H 64H-4EH 10H	100-1000%
00H 23H 18H	CHROMA COLOR	00H-01H	GREEN, BLUE * Even if this is rewritten by DT1, the HUE and SATURATION settings are not changed.
00H 23H 19H	HUE WIDTH	62H-00H-1EH	-30-0-30
00H 23H 1AH 1BH	HUE FINE	00H 00H-02H 68H	0-360
00H 23H 1CH 1DH	SATURATION WIDTH	7FH 00H-00H 00H-00H 7FH	-128-0-127
00H 23H 1EH 1FH	SATURATION FINE	00H 00H-01H 7FH	0-255
00H 23H 20H	FILL TYPE	00H-01H	BUS, MATTE
00H 23H 21H	MATTE COLOR	00H-07H	WHITE, YELLOW, CYAN, GREEN, MAGENTA, RED, BLUE, BLACK
00H 23H 22H	EDGE TYPE	00H-04H	OFF, BORDER, DROP, SHADOW, OUTLINE
00H 23H 23H	EDGE COLOR	00H-07H	WHITE, YELLOW, CYAN, GREEN, MAGENTA, RED, BLUE, BLACK
00H 23H 24H	EDGE WIDTH	00H-0FH	0-15
00H 23H 25H	PROGRAM OUT MODE	00H-01H	OFF, ON
00H 23H 26H	reserved		

○ VFX

Address	Parameter Name	Sys.Ex.Value	Meaning of Value
00H 24H 00H	VFX SW	00H-01H	OFF, ON
00H 24H 01H	VFX TYPE	00H-0FH	PART MOSAIC, BACKGROUND MOSAIC, FULL MOSAIC, WAVE, RGB REPLACE, COLOR PASS, NEGATIVE, COLORIZE, POSTERIZE, SILHOUETTE, EMBOSS, FIND EDGES, MONOCOLOR, HUE OFFSET, SATURATION OFFSET, VALUE OFFSET
00H 24H 02H 03H	MIX LEVEL	00H 00H-01H 7FH	0-255
00H 24H 04H	PART MOSAIC BLOCK SIZE	00H-07H	OFF (1x1), 4 x 4, 8 x 8, 16 x 16, 32 x 32, 64 x 64, 128 x 128, 256 x 256
00H 24H 05H 06H	PART MOSAIC POSITION H	78H 18H-00H 00H-07H 68H	-100.0-0-100.0%
00H 24H 07H 08H	PART MOSAIC POSITION V	78H 18H-00H 00H-07H 68H	-100.0-0-100.0%
00H 24H 09H 0AH	PART MOSAIC AREA SIZE	00H 64H-07H 68H	10.0-100.0%
00H 24H 0BH 0CH	PART MOSAIC AREA CORRECTION H	70H 30H-00H 00H-0FH 50H	-2000-0-2000
00H 24H 0DH 0EH	PART MOSAIC AREA CORRECTION V	70H 30H-00H 00H-0FH 50H	-2000-0-2000
00H 24H 0FH	BG MOSAIC BLOCK SIZE	00H-07H	OFF (1x1), 4 x 4, 8 x 8, 16 x 16, 32 x 32, 64 x 64, 128 x 128, 256 x 256
00H 24H 10H 11H	BG MOSAIC POSITION H	78H 18H-00H 00H-07H 68H	-100.0-0-100.0%

Address	Parameter Name	Sys.Ex.Value	Meaning of Value
00H 24H 12H 13H	BG MOSAIC POSITION V	78H 18H-00H 00H-07H 68H	-100.0-0-100.0%
00H 24H 14H 15H	BG MOSAIC AREA SIZE	00H 64H-07H 68H	10.0-100.0%
00H 24H 16H 17H	BG MOSAIC AREA CORRECTION H	70H 30H-00H 00H-0FH 50H	-2000-0-2000
00H 24H 18H 19H	BG MOSAIC AREA CORRECTION V	70H 30H-00H 00H-0FH 50H	-2000-0-2000
00H 24H 1AH	FULL MOSAIC BLOCK SIZE	00H-07H	OFF (1x1), 4 x 4, 8 x 8, 16 x 16, 32 x 32, 64 x 64, 128 x 128, 256 x 256
00H 24H 1BH 1CH	WAVE GAIN	00H 00H-01H 7FH	0-255
00H 24H 1DH	WAVE TYPE	00H-07H	0-7
00H 24H 1EH	RGB REPLACE TYPE	00H-05H	OFF (R.G.B), B.R.G, G.B.R, R.B.G, G.R.B, B.G.R
00H 24H 1FH	COLOR PASS TYPE	01H-3FH	1-63
00H 24H 20H	NEGATIVE TYPE	01H-07H	Cr, Cb, CbCr, Y, YCr, YCb, YCbCr
00H 24H 21H	COLORIZE TYPE	00H-07H	1-8
00H 24H 22H	POSTERIZE LEVEL	00H-03H	1-4
00H 24H 23H	SILHOUETTE TYPE	00H-7FH	1-128
00H 24H 24H	EMBOSS TYPE	00H-7FH	1-128
00H 24H 25H	EMBOSS CONTRAST	00H-0FH	0-15
00H 24H 26H	FIND EDGES FG COLOR	00H-0FH	0-15
00H 24H 27H	FIND EDGES BG COLOR	00H-0FH	0-15
00H 24H 28H	MONOCOLOR Pb COLOR	00H-3FH	0-63
00H 24H 29H	MONOCOLOR Pr COLOR	00H-3FH	0-63
00H 24H 2AH 2BH	HUE OFFSET VALUE	00H 00H-02H 67H	0-359
00H 24H 2CH 2DH	SATURATION OFFSET VALUE	7EH 00H-00H 00H-01H 7FH	-256-0-255
00H 24H 2EH 2FH	VALUE OFFSET VALUE	7EH 00H-00H 00H-01H 7FH	-256-0-255

○ Panel

Address	Parameter Name	Sys.Ex.Value	Meaning of Value
00H 25H 00H	Background Channel	00H-01H	INPUT 1, 2
00H 25H 01H 02H	Video Fader Position	00H 00H-03H 7FH	0-511
00H 25H 03H	Output Fade Level	00H-7FH	0-127
00H 25H 04H	Effects Type	00H-03H	MIX, WIPE, PinP, KEY

● Audio Parameter Area

○ Audio Input

* "xxH" corresponds to the respective channels as indicated below.

xxH =0H-04H (AUDIO IN 1, AUDIO IN 2, USB IN, HDMI IN 1, HDMI IN 2)

Address	Parameter Name	Sys.Ex.Value	Meaning of Value
01H xxH 00H	ANALOG GAIN	00H-37H	0-55dB * AUDIO IN 1/2 only
01H xxH 01H 02H 03H	INPUT LEVEL	7EH 00H 00H, 7FH 79H 60H- 00H 00H 00H-00H 00H 64H	-INFdB, -80.0-0.0-10.0dB
01H xxH 04H	INPUT MUTE	00H-01H	OFF, ON
01H xxH 05H	PLUG IN POWER	00H-01H	OFF, ON * AUDIO IN 1/2 only
01H xxH 06H	MONO	00H-01H	OFF, ON
01H xxH 07H	SOLO	00H-01H	OFF, ON
01H xxH 08H	EFFECT PRESET	00H-04H	DEFAULT, MEETING, INTERVIEW, AMBIENT MIC, WINDY FIELD * Even if this is rewritten by DT1, the effect settings are not changed.
01H xxH 09H 0AH	DELAY	00H 00H-27H 08H	0.0-500.0msec
01H xxH 0BH	REVERB SEND	00H-7FH	0-127
01H xxH 0CH	HIGH PASS FILTER 80Hz	00H-01H	OFF, ON
01H xxH 0DH	NOISE GATE SW	00H-01H	OFF, ON
01H xxH 0EH	NOISE GATE THRESHOLD	30H-00H	-80-0dB
01H xxH 0FH	NOISE GATE RELEASE	00H-7FH	30-5000ms

Address	Parameter Name	Sys.Ex.Value	Meaning of Value
01H xxH 10H	DE-ESSOR SW	00H-01H	OFF, ON
01H xxH 11H	DE-ESSOR SENS	00H-64H	0-100
01H xxH 12H	DE-ESSOR DEPTH	00H-64H	0-100
01H xxH 13H	COMPRESSOR SW	00H-01H	OFF, ON
01H xxH 14H	COMPRESSOR THRESHOLD	4EH-00H	-50-0dB
01H xxH 15H	COMPRESSOR RATIO	00H-0DH	1.00 : 1, 1.12 : 1, 1.25 : 1, 1.40 : 1, 1.60 : 1, 1.80 : 1, 2.00 : 1, 2.50 : 1, 3.20 : 1, 4.00 : 1, 5.60 : 1, 8.00 : 1, 16.0 : 1, INF : 1
01H xxH 16H	COMPRESSOR ATTACK	00H-73H	0.0-100msec
01H xxH 17H	COMPRESSOR RELEASE	00H-7FH	30-5000ms
01H xxH 18H	COMPRESSOR MAKEUP GAIN	58H-00H-28H	-40-40dB
01H xxH 19H	EQUALIZER SW	00H-01H	OFF, ON
01H xxH 1AH	EQUALIZER Hi GAIN	04H-7CH	-12.0-12.0dB
01H xxH 1BH	EQUALIZER Hi FREQUENCY	24H-3EH	1.00-20.0kHz
01H xxH 1CH	EQUALIZER Mid GAIN	04H-7CH	-12.0-12.0dB
01H xxH 1DH	EQUALIZER Mid FREQUENCY	02H-3EH	20Hz-20.0kHz
01H xxH 1EH	EQUALIZER Mid Q	00H-05H	0.5-16.0
01H xxH 1FH	EQUALIZER Lo GAIN	04H-7CH	-12.0-12.0dB
01H xxH 20H	EQUALIZER Lo FREQUENCY	02H-2AH	20-2.00kHz
01H xxH 21H	VOICE CHANGER SW	00H-01H	OFF, ON
01H xxH 22H	VOICE CHANGER PITCH	74H-00H-0CH	-12-+12
01H xxH 23H	VOICE CHANGER FORMANT	76H-00H-0AH	-10-+10
01H xxH 24H	VOICE CHANGER ROBOT	00H-01H	OFF, ON
01H xxH 25H	VOICE CHANGER MIX	00H-64H	0-100

○ Audio Output Assign

Address	Parameter Name	Sys.Ex.Value	Meaning of Value
01H 10H 00H	PHONES OUT	00H-01H	MASTER OUTPUT, AUX
01H 10H 01H	USB OUT	00H-01H	MASTER OUTPUT, AUX
01H 10H 02H	HDMI OUT PROGRAM	00H-02H	AUTO, MASTER OUTPUT, AUX
01H 10H 03H	HDMI OUT PREVIEW	00H-02H	AUTO, MASTER OUTPUT, AUX

○ Audio Output

Address	Parameter Name	Sys.Ex.Value	Meaning of Value
01H 11H 00H 01H 02H	OUTPUT LEVEL	7EH 00H 00H, 7FH 79H 60H- 00H 00H 00H-00H 00H 64H	-INFdB, -80.0-0.0-10.0dB
01H 11H 03H	OUTPUT DELAY	00H 00H-27H 08H	0.0-500.0msec
01H 11H 04H 05H	OUTPUT MUTE	00H-01H	OFF, ON
01H 11H 06H	LIMITER SW	00H-01H	OFF, ON
01H 11H 07H	LIMITER THRESHOLD	58H-00H	-40-0.0dB
01H 11H 08H	REVERB SW	00H-01H	OFF, ON
01H 11H 09H	REVERB LEVEL	00H-7FH	0-127
01H 11H 0AH	REVERB TYPE	00H-01H	ROOM, HALL
01H 11H 0BH	REVERB SIZE	01H-14H	1-20
01H 11H 0CH	EQUALIZER SW	00H-01H	OFF, ON
01H 11H 0DH	EQUALIZER Hi GAIN	04H-7CH	-12.0-12.0dB
01H 11H 0EH	EQUALIZER Hi FREQUENCY	24H-3EH	1.00-20.0kHz
01H 11H 0FH	EQUALIZER Mid GAIN	04H-7CH	-12.0-12.0dB
01H 11H 10H	EQUALIZER Mid FREQUENCY	02H-3EH	20Hz-20.0kHz
01H 11H 11H	EQUALIZER Mid Q	00H-05H	0.5-16.0
01H 11H 12H	EQUALIZER Lo GAIN	04H-7CH	-12.0-12.0dB
01H 11H 13H	EQUALIZER Lo FREQUENCY	02H-2AH	20-2.00kHz
01H 11H 14H	MULTI BAND COMPRESSOR SW	00H-01H	OFF, ON
01H 11H 15H	MB COMP Hi THRESHOLD	58H-00H	-40-0.0dB
01H 11H 16H	MB COMP Hi RATIO	00H-0DH	1.00 : 1, 1.12 : 1, 1.25 : 1, 1.40 : 1, 1.60 : 1, 1.80 : 1, 2.00 : 1, 2.50 : 1, 3.20 : 1, 4.00 : 1, 5.60 : 1, 8.00 : 1, 16.0 : 1, INF : 1
01H 11H 17H	MB COMP Mid THRESHOLD	7CH 70H-00H 00H	-40.0-0.0dB
01H 11H 18H	MB COMP Mid RATIO	00H-0DH	1.00 : 1, 1.12 : 1, 1.25 : 1, 1.40 : 1, 1.60 : 1, 1.80 : 1, 2.00 : 1, 2.50 : 1, 3.20 : 1, 4.00 : 1, 5.60 : 1, 8.00 : 1, 16.0 : 1, INF : 1
01H 11H 19H	MB COMP Lo THRESHOLD	7CH 70H-00H 00H	-40.0-0.0dB
01H 11H 1AH	MB COMP Lo RATIO	00H-0DH	1.00 : 1, 1.12 : 1, 1.25 : 1, 1.40 : 1, 1.60 : 1, 1.80 : 1, 2.00 : 1, 2.50 : 1, 3.20 : 1, 4.00 : 1, 5.60 : 1, 8.00 : 1, 16.0 : 1, INF : 1

○ Audio AUX Output

Address	Parameter Name	Sys.Ex.Value	Meaning of Value
01H 12H 00H 01H 02H	AUX LEVEL	7EH 00H 00H, 7FH 79H 60H-00H 00H 00H-00H 00H 64H	-INFdB, -80.0-0.0-10.0dB
01H 12H 03H	AUX MUTE	00H-01H	OFF, ON
01H 12H 04H 05H	AUX DELAY	00H 00H-27H 08H	0.0-500.0msec
01H 12H 06H	LIMITER SW	00H-01H	OFF, ON
01H 12H 07H	LIMITER THRESHOLD	7CH 70H-00H 00H	-40.0-0.0dB
01H 12H 08H	AUX SEND AUDIO IN 1	2FH-00H	-INFdB, -80-0dB
01H 12H 09H	AUX SEND AUDIO IN 2	2FH-00H	-INFdB, -80-0dB
01H 12H 0AH	AUX SEND USB IN	2FH-00H	-INFdB, -80-0dB
01H 12H 0BH	AUX SEND HDMI IN 1	2FH-00H	-INFdB, -80-0dB
01H 12H 0CH	AUX SEND HDMI IN 2	2FH-00H	-INFdB, -80-0dB
01H 12H 0DH	AUX EFFECT AUDIO IN 1	00H-02H	DRY, PRE FADER, POST FADER
01H 12H 0EH	AUX EFFECT AUDIO IN 2	00H-02H	DRY, PRE FADER, POST FADER
01H 12H 0FH	AUX EFFECT USB IN	00H-02H	DRY, PRE FADER, POST FADER
01H 12H 10H	AUX EFFECT HDMI IN 1	00H-02H	DRY, PRE FADER, POST FADER
01H 12H 11H	AUX EFFECT HDMI IN 2	00H-02H	DRY, PRE FADER, POST FADER

○ Audio USB Output

Address	Parameter Name	Sys.Ex.Value	Meaning of Value
01H 13H 00H 01H 02H	USB OUT LEVEL	7EH 00H 00H, 7FH 79H 60H-00H 00H 00H-00H 00H 64H	-INFdB, -80.0-0.0-10.0dB
01H 13H 03H	USB OUT MUTE	00H-01H	OFF, ON
01H 13H 04H 05H	USB OUT DELAY	00H 00H-27H 08H	0.0-500.0msec
01H 13H 06H	EQUALIZER SW	00H-01H	OFF, ON
01H 13H 07H	EQUALIZER Hi GAIN	04H-7CH	-12.0-12.0dB
01H 13H 08H	EQUALIZER Hi FREQUENCY	24H-3EH	1.00-20.0kHz
01H 13H 09H	EQUALIZER Mid GAIN	04H-7CH	-12.0-12.0dB
01H 13H 0AH	EQUALIZER Mid FREQUENCY	02H-3EH	20Hz-20.0kHz
01H 13H 0BH	EQUALIZER Mid Q	00H-05H	0.5-16.0
01H 13H 0CH	EQUALIZER Lo GAIN	04H-7CH	-12.0-12.0dB
01H 13H 0DH	EQUALIZER Lo FREQUENCY	02H-2AH	20-2.00kHz

○ Audio Follow

Address	Parameter Name	Sys.Ex.Value	Meaning of Value
01H 20H 00H	HDMI IN 1	00H-01H	OFF, ON
01H 20H 01H	HDMI IN 2	00H-01H	OFF, ON
01H 20H 02H	AUDIO IN 1	00H-02H	OFF, INPUT 1, INPUT 2
01H 20H 03H	AUDIO IN 2	00H-02H	OFF, INPUT 1, INPUT 2
01H 20H 04H	USB IN	00H-02H	OFF, INPUT 1, INPUT 2

● System Parameter Area

○ Version Parameter

Address	Parameter Name	Sys.Ex.Value	Meaning of Value
02H 00H 00H	System Version Major	00H-09H	Version Number (Read Only)
02H 00H 01H	System Version Minor (1)	00H-09H	Version Number (Read Only)
02H 00H 02H	System Version Minor (2)	00H-09H	Version Number (Read Only)
02H 00H 03H	System Version Build (1)	00H-09H	Version Number (Read Only)
02H 00H 04H	System Version Build (2)	00H-09H	Version Number (Read Only)
02H 00H 05H	System Version Build (3)	00H-09H	Version Number (Read Only)

○ System

Address	Parameter Name	Sys.Ex.Value	Meaning of Value
02H 01H 00H	HDCP	00H-01H	OFF, ON
02H 01H 01H	FRAME RATE	00H-01H	59.94Hz, 50Hz
02H 01H 02H	INPUT 1 SW ASSIGN	00H-04H	← AUTO TAKE, ← AUTO TAKE →, ← CUT, ← CUT →, ← TRANSFORM
02H 01H 03H	INPUT 2 SW ASSIGN	00H-04H	AUTO TAKE →, ← AUTO TAKE →, CUT →, ← CUT →, TRANSFORM →
02H 01H 04H	OUTPUT FADE LEFT ASSIGN	00H-07H	BLACK, WHITE, STILL IMAGE, CONTRAST, AUDIO, BLACK&AUDIO, WHITE&AUDIO, STILL IMAGE&AUDIO
02H 01H 05H	OUTPUT FADE RIGHT ASSIGN	00H-07H	BLACK, WHITE, STILL IMAGE, CONTRAST, AUDIO, BLACK&AUDIO, WHITE&AUDIO, STILL IMAGE&AUDIO
02H 01H 06H	AUDIO FX ASSIGN CTR1	00H-1BH	AUDIO IN 1 ANALOG GAIN, AUDIO IN 2 ANALOG GAIN, AUDIO IN 1 LEVEL, AUDIO IN 2 LEVEL, USB IN LEVEL, HDMI IN 1 LEVEL, HDMI IN 2 LEVEL, MASTER OUTPUT LEVEL, AUX OUTPUT LEVEL, USB OUTPUT LEVEL, AUDIO IN 1 DELAY, AUDIO IN 2 DELAY, USB IN DELAY, HDMI IN 1 DELAY, HDMI IN 2 DELAY, USB OUT DELAY, AUDIO IN 1 REVERB SEND, AUDIO IN 2 REVERB SEND, USB IN REVERB SEND, HDMI IN 1 REVERB SEND, HDMI IN 2 REVERB SEND, REVERB LEVEL, AUDIO IN 1 VOICE PITCH, AUDIO IN 2 VOICE PITCH, AUDIO IN 1 VOICE FORMANT, AUDIO IN 2 VOICE FORMANT, AUDIO IN 1 VOICE MIX, AUDIO IN 2 VOICE MIX
02H 01H 07H	AUDIO FX ASSIGN CTR2	00H-1BH	AUDIO IN 1 ANALOG GAIN, AUDIO IN 2 ANALOG GAIN, AUDIO IN 1 LEVEL, AUDIO IN 2 LEVEL, USB IN LEVEL, HDMI IN 1 LEVEL, HDMI IN 2 LEVEL, MASTER OUTPUT LEVEL, AUX OUTPUT LEVEL, USB OUTPUT LEVEL, AUDIO IN 1 DELAY, AUDIO IN 2 DELAY, USB IN DELAY, HDMI IN 1 DELAY, HDMI IN 2 DELAY, USB OUT DELAY, AUDIO IN 1 REVERB SEND, AUDIO IN 2 REVERB SEND, USB IN REVERB SEND, HDMI IN 1 REVERB SEND, HDMI IN 2 REVERB SEND, REVERB LEVEL, AUDIO IN 1 VOICE PITCH, AUDIO IN 2 VOICE PITCH, AUDIO IN 1 VOICE FORMANT, AUDIO IN 2 VOICE FORMANT, AUDIO IN 1 VOICE MIX, AUDIO IN 2 VOICE MIX
02H 01H 08H	PREVIEW LABEL	00H-01H	OFF, ON
02H 01H 09H	AUDIO LEVEL METER	00H-01H	OFF, ON
02H 01H 0AH	AUTO INPUT DETECT	00H-01H	OFF, ON
02H 01H 0BH	AUTO OFF	00H-01H	OFF, ON
02H 01H 0CH	TEST PATTERN	00H-05H	OFF, 75% COLOR BAR, 100% COLOR BAR, RAMP, STEP, HATCH
02H 01H 0DH	TEST TONE LEVEL	00H-03H	OFF, -20dB, -10dB, 0dB
02H 01H 0EH	TEST TONE FREQUENCY L	00H-02H	500Hz, 1kHz, 2kHz
02H 01H 0FH	TEST TONE FREQUENCY R	00H-02H	500Hz, 1kHz, 2kHz

○ Panel Lock

Address	Parameter Name	Sys.Ex.Value	Meaning of Value
02H 02H 00H	INPUT 1 SW	00H-01H	OFF, ON
02H 02H 01H	INPUT 2 SW	00H-01H	OFF, ON
02H 02H 02H	VIDEO FADER	00H-01H	OFF, ON
02H 02H 03H	OUTPUT FADE	00H-01H	OFF, ON
02H 02H 04H	VFX SW	00H-01H	OFF, ON
02H 02H 05H	EFFECT TYPE SW	00H-01H	OFF, ON
02H 02H 06H	CONTROL 1 ENCODER	00H-01H	OFF, ON
02H 02H 07H	CONTROL 2 ENCODER	00H-01H	OFF, ON

○ LED Assign

Address	Parameter Name	Sys.Ex.Value	Meaning of Value
02H 03H 00H	PROGRAM LED COLOR	00H-07H	RED, GREEN, YELLOW, BLUE, PURPLE, L.BLUE, WHITE, OFF
02H 03H 01H	PREVIEW LED COLOR	00H-07H	RED, GREEN, YELLOW, BLUE, PURPLE, L.BLUE, WHITE, OFF
02H 03H 02H	BG SELECT LED COLOR	00H-07H	RED, GREEN, YELLOW, BLUE, PURPLE, L.BLUE, WHITE, OFF
02H 03H 03H	INPUT 1 LED	00H-01H	OFF, ON
02H 03H 04H	INPUT 2 LED	00H-01H	OFF, ON
02H 03H 05H	VIDEO FADER LED	00H-01H	OFF, ON
02H 03H 06H	MENU LED	00H-01H	OFF, ON
02H 03H 07H	VFX LED	00H-01H	OFF, ON
02H 03H 08H	EFFECTS LED	00H-01H	OFF, ON
02H 03H 09H	OUTPUT FADE LEFT LED	00H-01H	OFF, ON
02H 03H 0AH	OUTPUT FADE RIGHT LED	00H-01H	OFF, ON

○ Effect Type SW Assign

Address	Parameter Name	Sys.Ex.Value	Meaning of Value
02H 04H 00H	MIX	00H-01H	DISABLE, ENABLE
02H 04H 01H	WIPE	00H-01H	DISABLE, ENABLE
02H 04H 02H	PinP	00H-01H	DISABLE, ENABLE
02H 04H 03H	KEY	00H-01H	DISABLE, ENABLE

○ Preset Memory

Address	Parameter Name	Sys.Ex.Value	Meaning of Value
02H 05H 00H	START UP	00H-08H	LAST MEMORY, MEMORY 1-8
02H 05H 01H	MEMORY PROTECT	00H-01H	OFF, ON
02H 05H 02H	FADE TIME	00H-28H	0.0-4.0sec
02H 05H 03H	FADE SW MIX/WIPE	00H-01H	OFF, ON
02H 05H 04H	FADE SW PinP	00H-01H	OFF, ON
02H 05H 05H	FADE SW KEY	00H-01H	OFF, ON
02H 05H 06H	LOAD PARAMETER VIDEO INPUT	00H-01H	OFF, ON
02H 05H 07H	LOAD PARAMETER VIDEO OUTPUT	00H-01H	OFF, ON
02H 05H 08H	LOAD PARAMETER TRANS TIME	00H-01H	OFF, ON
02H 05H 09H	LOAD PARAMETER MIX/WIPE	00H-01H	OFF, ON
02H 05H 0AH	LOAD PARAMETER PinP	00H-01H	OFF, ON
02H 05H 0BH	LOAD PARAMETER KEY	00H-01H	OFF, ON
02H 05H 0CH	LOAD PARAMETER VFX	00H-01H	OFF, ON
02H 05H 0DH	LOAD PARAMETER VIDEO CROSSPOINT	00H-01H	OFF, ON
02H 05H 0EH	LOAD PARAMETER VIDEO FADER	00H-01H	OFF, ON
02H 05H 0FH	LOAD PARAMETER AUDIO INPUT	00H-01H	OFF, ON
02H 05H 10H	LOAD PARAMETER AUDIO OUTPUT	00H-01H	OFF, ON
02H 05H 11H	LOAD PARAMETER AUDIO FOLLOW	00H-01H	OFF, ON

○ CTL/EXP

Address	Parameter Name	Sys.Ex.Value	Meaning of Value
02H 06H 00H	CTL/EXP TYPE	00H-02H	OFF, CTL A & CTL B, EXP
02H 06H 01H	CTL A ASSIGN	00H-19H	N/A, EFFECT TYPE SW, EFFECT MIX, EFFECT WIPE, EFFECT PinP, EFFECT KEY, VFX SW, INPUT 1 SW, INPUT 2 SW, ← AUTO TAKE →, ← CUT →, STILL IMAGE, INPUT 1 AUDIO MUTE, INPUT 2 AUDIO MUTE, AUDIO IN AUDIO MUTE, AUDIO OUTPUT MUTE, OUTPUT FADE LEFT, OUTPUT FADE RIGHT, LOAD MEMORY 1-8
02H 06H 02H	CTL B ASSIGN	00H-19H	N/A, EFFECT TYPE SW, EFFECT MIX, EFFECT WIPE, EFFECT PinP, EFFECT KEY, VFX SW, INPUT 1 SW, INPUT 2 SW, ← AUTO TAKE →, ← CUT →, STILL IMAGE, INPUT 1 AUDIO MUTE, INPUT 2 AUDIO MUTE, AUDIO IN AUDIO MUTE, AUDIO OUTPUT MUTE, OUTPUT FADE LEFT, OUTPUT FADE RIGHT, LOAD MEMORY 1-8
02H 06H 03H	EXP ASSIGN	00H-0AH	N/A, VIDEO FADER, ← CUT →, VFX MIX LEVEL, OUTPUT FADE LEFT, OUTPUT FADE RIGHT, STILL IMAGE, INPUT 1 AUDIO LEVEL, INPUT 2 AUDIO LEVEL, AUDIO IN AUDIO LEVEL, AUDIO OUTPUT LEVEL

○ CAPTURE IMAGE

Address	Parameter Name	Sys.Ex.Value	Meaning of Value
02H 07H 00H	CAPTURE SHORTCUT	00H-01H	DISABLE, ENABLE
02H 07H 01H	SAVE TO INTERNAL STORAGE	00H-01H	DISABLE, ENABLE

○ AUTO SWITCHING

Address	Parameter Name	Sys.Ex.Value	Meaning of Value
02H 08H 00H	AUTO SWITCHING SW	00H-01H	OFF, ON
02H 08H 01H	AUTO SWITCHING TYPE	00H-01H	INPUT SCAN, PRESET MEMORY SCAN
02H 08H 02H	INPUT SCAN TIME INPUT 1	00H-78H	OFF, 1-120 sec
02H 08H 03H	INPUT SCAN TIME INPUT 2	00H-78H	OFF, 1-120 sec
02H 08H 04H	INPUT SCAN TRANS TIME	00H-28H	0.0 sec-4.0 sec
02H 08H 05H	MEMORY SCAN SEQUENCE	00H-02H	NORMAL, REVERSE, RANDOM
02H 08H 06H	MEMORY SCAN MEMORY 1 TIME	00H-78H	OFF, 1-120 sec
02H 08H 07H	MEMORY SCAN MEMORY 2 TIME	00H-78H	OFF, 1-120 sec
02H 08H 08H	MEMORY SCAN MEMORY 3 TIME	00H-78H	OFF, 1-120 sec
02H 08H 09H	MEMORY SCAN MEMORY 4 TIME	00H-78H	OFF, 1-120 sec
02H 08H 0AH	MEMORY SCAN MEMORY 5 TIME	00H-78H	OFF, 1-120 sec
02H 08H 0BH	MEMORY SCAN MEMORY 6 TIME	00H-78H	OFF, 1-120 sec

Address	Parameter Name	Sys.Ex.Value	Meaning of Value
02H 08H 0CH	MEMORY SCAN MEMORY 7 TIME	00H-78H	OFF, 1-120 sec
02H 08H 0DH	MEMORY SCAN MEMORY 8 TIME	00H-78H	OFF, 1-120 sec

● Other Parameter Area

○ Preset Memory

Address	Parameter Name	Sys.Ex.Value	Meaning of Value
0AH 00H 00H	Memory Load Trigger	00H-07H	Memory 1-8 (Write Only)
0AH 00H 01H	Memory Save Trigger	00H-07H	Memory 1-8 (Write Only)
0AH 00H 02H	Memory Initialize Trigger	00H-07H	Memory 1-8 (Write Only)
0AH 00H 03H	Loaded Memory Number	00H-07H, 7FH	Memory 1-8, Last Memory (Read only)

● Preset Memory Area

You can load or rewrite the stored contents of the preset memories.

* The 2nd byte and 3rd byte of a Preset Memory Area address, and the value range, are in common with the Video Parameter Area (00H 00H 00H) and the Audio Parameter Area (01H 00H 00H).

Address	Parameter Name
10H 00H 00H	Video Parameter (Memory 1)
11H 00H 00H	Audio Parameter (Memory 1)
12H 00H 00H	Video Parameter (Memory 2)
13H 00H 00H	Audio Parameter (Memory 2)
14H 00H 00H	Video Parameter (Memory 3)
15H 00H 00H	Audio Parameter (Memory 3)
16H 00H 00H	Video Parameter (Memory 4)
17H 00H 00H	Audio Parameter (Memory 4)
18H 00H 00H	Video Parameter (Memory 5)
19H 00H 00H	Audio Parameter (Memory 5)
1AH 00H 00H	Video Parameter (Memory 6)
1BH 00H 00H	Audio Parameter (Memory 6)
1CH 00H 00H	Video Parameter (Memory 7)
1DH 00H 00H	Audio Parameter (Memory 7)
1EH 00H 00H	Video Parameter (Memory 8)
1FH 00H 00H	Audio Parameter (Memory 8)

3. Supplementary Material

● Decimal and Hexadecimal Table

(Hexadecimal Numbers are Indicated by "H")

In MIDI documentation, data values and addresses/sizes of exclusive messages etc. are expressed as hexadecimal values for each 7 bits.

The following table shows how these correspond to decimal numbers.

D	H	D	H	D	H	D	H
0	00H	32	20H	64	40H	96	60H
1	01H	33	21H	65	41H	97	61H
2	02H	34	22H	66	42H	98	62H
3	03H	35	23H	67	43H	99	63H
4	04H	36	24H	68	44H	100	64H
5	05H	37	25H	69	45H	101	65H
6	06H	38	26H	70	46H	102	66H
7	07H	39	27H	71	47H	103	67H
8	08H	40	28H	72	48H	104	68H
9	09H	41	29H	73	49H	105	69H
10	0AH	42	2AH	74	4AH	106	6AH
11	0BH	43	2BH	75	4BH	107	6BH
12	0CH	44	2CH	76	4CH	108	6CH
13	0DH	45	2DH	77	4DH	109	6DH
14	0EH	46	2EH	78	4EH	110	6EH
15	0FH	47	2FH	79	4FH	111	6FH
16	10H	48	30H	80	50H	112	70H
17	11H	49	31H	81	51H	113	71H
18	12H	50	32H	82	52H	114	72H
19	13H	51	33H	83	53H	115	73H
20	14H	52	34H	84	54H	116	74H
21	15H	53	35H	85	55H	117	75H
22	16H	54	36H	86	56H	118	76H
23	17H	55	37H	87	57H	119	77H
24	18H	56	38H	88	58H	120	78H
25	19H	57	39H	89	59H	121	79H
26	1AH	58	3AH	90	5AH	122	7AH
27	1BH	59	3BH	91	5BH	123	7BH
28	1CH	60	3CH	92	5CH	124	7CH
29	1DH	61	3DH	93	5DH	125	7DH
30	1EH	62	3EH	94	5EH	126	7EH
31	1FH	63	3FH	95	5FH	127	7FH

D: decimal

H: hexadecimal

- * Decimal expressions used for MIDI channel, bank select, and program change are 1 greater than the decimal value shown in the above table.
- * Hexadecimal values in 7-bit units can express a maximum of 128 levels in one byte of data. If the data requires greater resolution, two or more bytes are used. For example, a value indicated by a hexadecimal expression in two 7-bit bytes aa bbH would be aa x 128 + bb.
- * Data marked "nibbled" is expressed in hexadecimal in 4-bit units. A value expressed as a 2-byte nibble 0a 0bH has the value of a x 16 + b.

<Example1>

What is the decimal expression of 5AH?

From the preceding table, 5AH = 90

<Example2>

What is the decimal expression of the value 12 34H given as hexadecimal for each 7 bits?

From the preceding table, since 12H = 18 and 34H = 52

$$18 \times 128 + 52 = 2356$$

<Example3>

What is the decimal expression of the nibbled value 0A 03 09 0D?

From the preceding table, since 0AH = 10, 03H = 3, 09H = 9, 0DH = 13

$$((10 \times 16 + 3) \times 16 + 9) \times 16 + 13 = 41885$$

<Example4>

What is the nibbled expression of the decimal value 1258?

$$16) \underline{1258}$$

$$16) \underline{78} \dots 10$$

$$16) \underline{4} \dots 14$$

$$0 \dots 4$$

Since from the preceding table, 0 = 00H, 4 = 04H, 14 = 0EH, 10 = 0AH, the answer is 00 04 0E 0AH.

● MIDI Message Examples

<Example 1> 92H 3EH 5FH

9n is a note on status and n is the MIDI channel number.

As 2H = 2, 3EH = 62 and 5FH = 95, this is a note on message of MIDI CH = 3, note number 62 (D4) and velocity 95.

<Example 2> CEH 49H

CnH is program change status, and n is the MIDI channel number.

As EH = 14 and 49H = 73, this is a program change message of MIDI CH = 15 and program number 74 (in the GS sound map, Flute).

● Example of an Exclusive Message and Calculating a Checksum

Roland Exclusive messages are transmitted with a checksum at the end (before F7) to make sure that the message was correctly received. The value of the checksum is determined by the address and data (or size) of the transmitted exclusive message.

○ How to Calculate the Checksum

(Hexadecimal Numbers are Indicated by "H")

The checksum is a value that produces a lower 7 bits of zero when the address, size, and checksum itself are summed. If the exclusive message to be transmitted has an address of aa bb ccH and the data is dd ee ffH, the actual calculation would be as follows:

$$aa + bb + cc + dd + ee + ff = \text{sum}$$

$$\text{sum} / 128 = \text{quotient} \dots \text{remainder}$$

$$128 - \text{remainder} = \text{checksum}$$

(However, the checksum will be 0 if the remainder is 0.)

<Example>

Setting Dissolve Time Ctrl Assign in MIDI Visual Control to Modulation for Control Changes

From the "Parameter Address Map," the start address of the Dissolve Time Ctrl Assign in MIDI Visual Control is 10H 10H 02H and the Modulation parameter in Control Change is 00H 01H. Therefore ...

F0H	7EH	00H	0CH 01H	10H 10H 02H	00H 01H	??H	F7H
(1)	(2)	(3)	(4)	(5)	(6)	(7)	(8)

- (1) Exclusive Status
- (2) ID Number (Universal SysEx Non Realtime)
- (3) Device ID (0)
- (4) Sub ID (MIDI Visual Control Version 1.0)
- (5) Address
- (6) Data
- (7) Checksum
- (8) EOx

Next calculate the checksum. Add (5) to (6).

$$10H + 10H + 02H + 00H + 01H = 16 + 16 + 2 + 0 + 1 = 35 \text{ (sum)}$$

$$35 \text{ (sum)} / 128 = 0 \text{ (quotient)} \dots 35 \text{ (remainder)}$$

$$\text{Checksum} = 128 - 35 \text{ (remainder)} = 93 = 5DH$$

Thus, the message to transmit is :

F0H 7EH 00H 0CH 01H 10H 10H 02H 00H 01H 5DH F7H

MIDI Implementation Chart

Function		Transmitted	Recognized	Remarks
Basic Channel	Default	1	1	
	Changed	1	1	
Mode	Default	×	×	
	Messages	×	×	
	Altered	*****	*****	
Note Number	True Voice	×	×	
Velocity	Note On	×	×	
	Note Off	×	×	
After Touch	Key's	×	×	
	Channel's	×	×	
Pitch Bend		×	×	
Control Change	0-9	×	×	Controls various parameters
	10-31	×	0	
	32-51	×	0	
	52-60	×	×	
	61-119	×	0	
Program Change	: True Number	×	×	
System Exclusive		0	0	
System Common	: Song Position	×	×	
	: Song Select	×	×	
	: Tune Request	×	×	
System Real Time	: Clock	×	×	
	: Commands	×	×	
Aux Messages	: All Sound Off	×	×	
	: Reset All Controllers	×	×	
	: Local On/Off	×	×	
	: All Notes Off	×	×	
	: Active Sensing	×	×	
	: System Reset	×	×	
Notes				

Appendix

Block Diagram

Video block

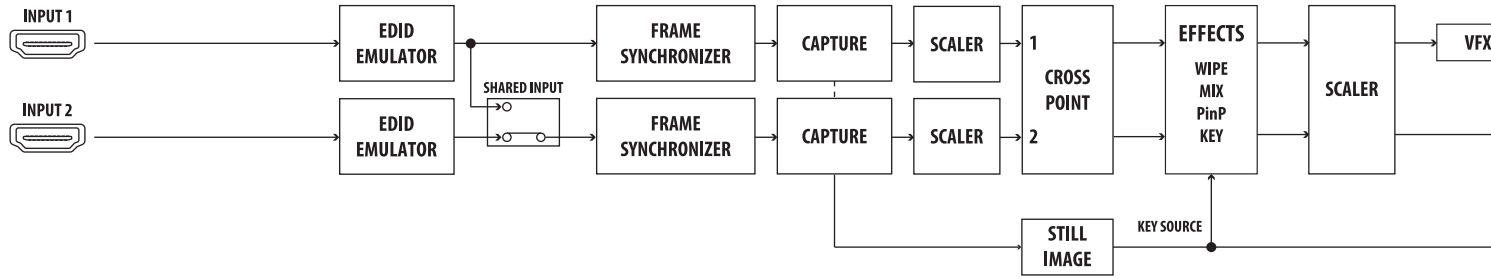

Audio block

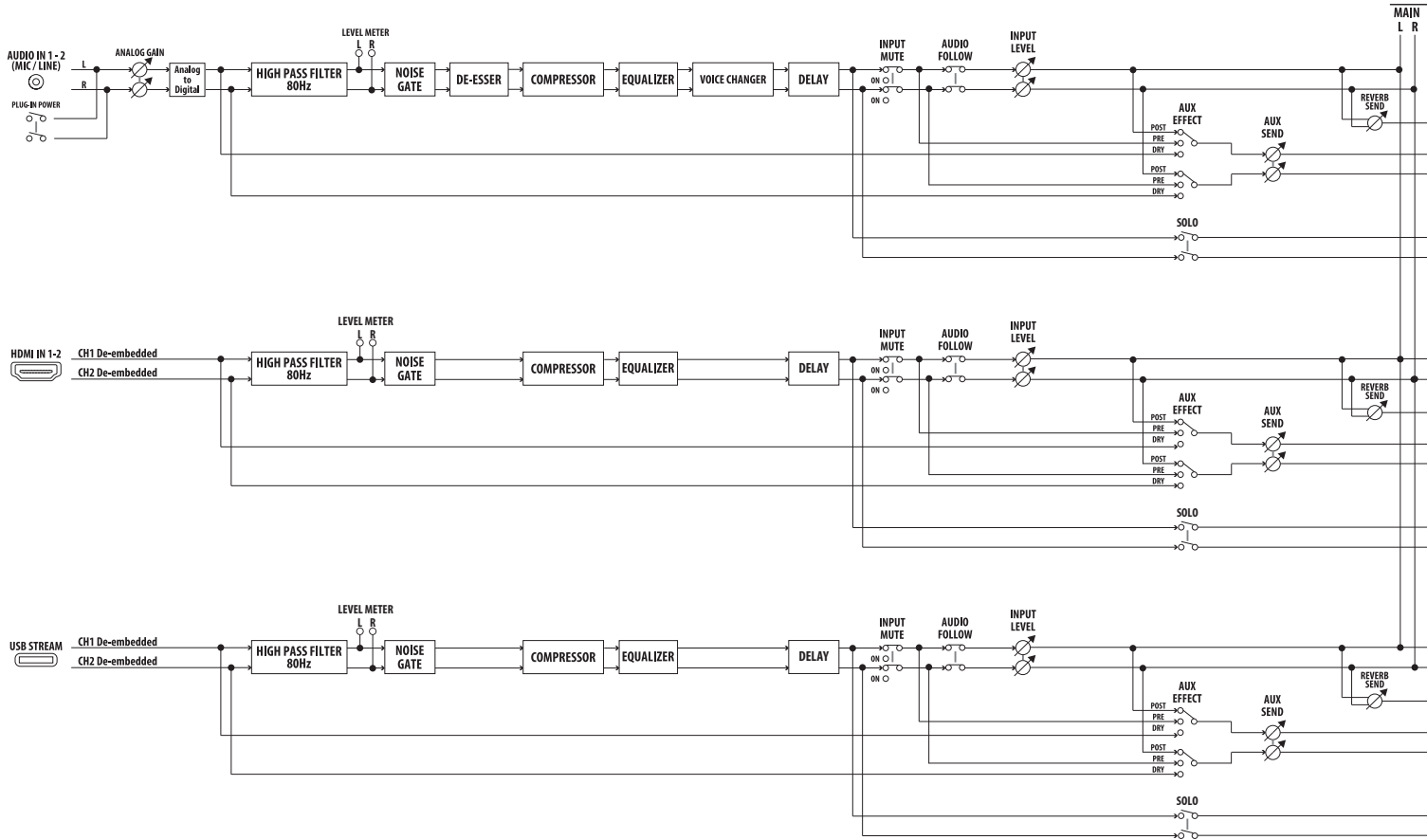

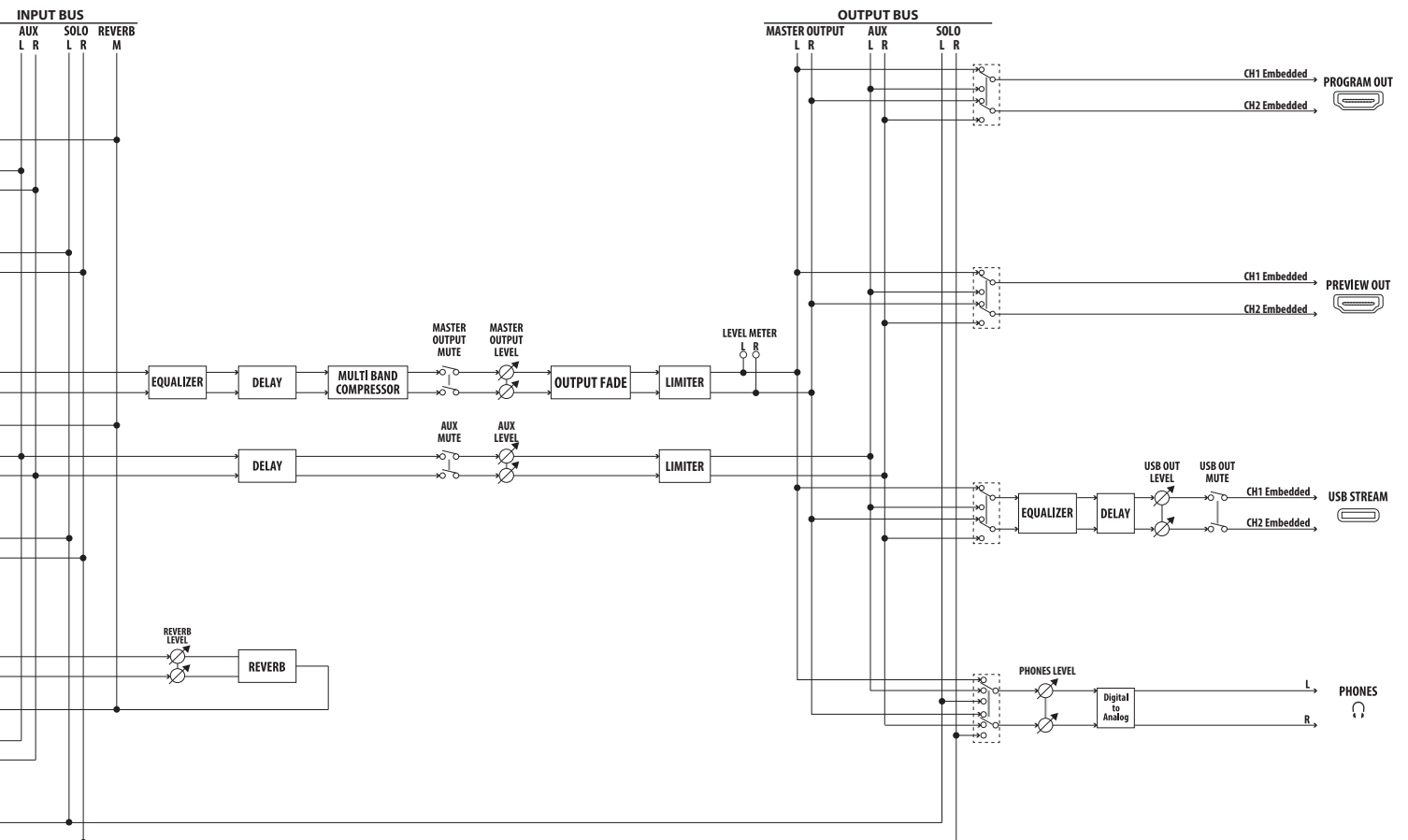
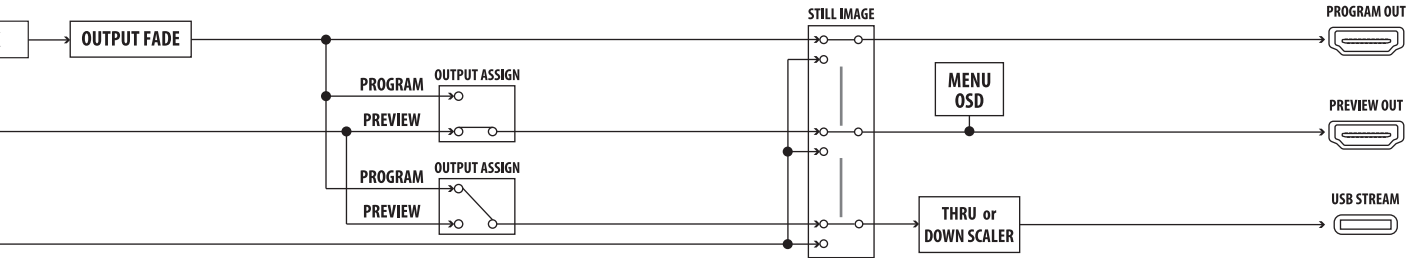

Dimensions

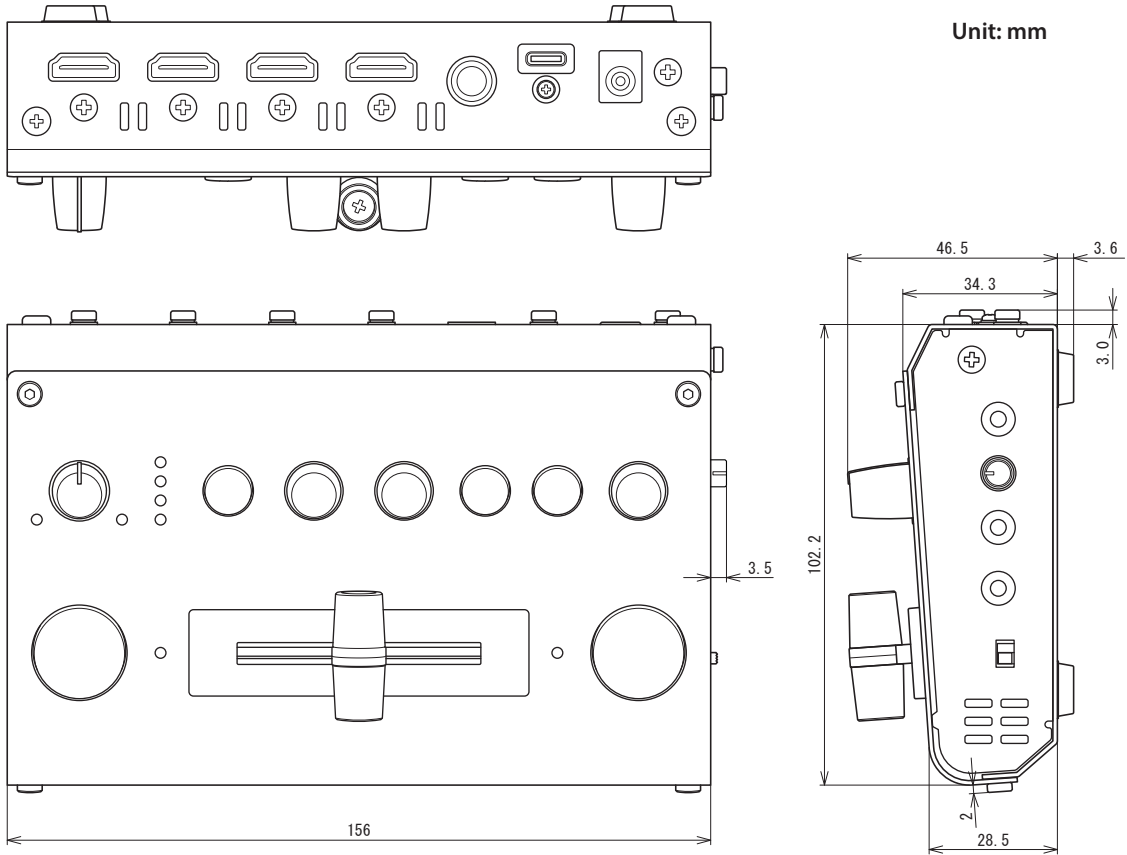

Troubleshooting

If you suspect a malfunction, please check the following points. If this does not resolve the problem, contact a nearby Roland Service Center.

Problem	Items to check	Action	Page
Video-related problems			
No picture is input.	Could you be inputting copy-protected (HDCP) video?	If you want to input copy-protected (HDCP) video, set the System menu "HDCP" setting to "ON."	p. 11
Video input from a computer is distorted.	If video is being input from a computer, the image can sometimes be skewed, flickering, or otherwise distorted.	This is a phenomenon called "tearing," and is not a malfunction.	—
No video appears	Has the [OUTPUT FADE] knob been turned clockwise or counterclockwise?	With the factory settings, the program output video is faded if the [OUTPUT FADE] knob is turned counter-clockwise. If the knob is turned all the way clockwise, a still image is output. To output video, set the [OUTPUT FADE] knob to the center.	p. 19 p. 21
	Does the output destination display support copy protection (HDCP)?	If you are outputting copy-protected (HDCP) video, and a display that does not support HDCP is connected, the video might not be shown or might be incorrect. Connect a display that supports HDCP.	p. 11
	Does the output destination display support the output format that is specified on the V-02HD?	If the display does not support the V-02HD's output format, the video might not be shown correctly. Change the output format in VIDEO OUTPUT menu → "SCALING" → "FORMAT." If the menu is no longer shown... If the menu is no longer shown in the display, use the following procedure to restart the V-02HD. This returns the output format to "1080p" (default value). 1. Turn off the power. 2. While holding down the [1] button and the [2] button, turn on the power.	p. 8
"Snowy"-noise video is shown.	It might be that the HDMI signal is not being correctly transmitted or received.	Reconnect the HDMI cable.	—
Color is wrong.	Do the color space settings of the output-destination device and the V-02HD match?	Change the color space in VIDEO OUTPUT menu → "PROGRAM OUT," "PREVIEW OUT" → "COLOR SPACE."	p. 9
		Depending on the device, the color space might be linked with the DVI/HDMI selection or the selection of format. If so, changing the color space of the output-destination device might solve the problem.	—
An edge of the video shown on a display is cut off.	Are the display's settings correct?	Depending on the display, it might overscan automatically. Change the settings of the device.	—
Compositing a logo or video is not possible.	When using key compositing, is the key type (luminance key, chroma key) selected correctly?	Use the KEY menu setting "KEY TYPE" to select either luminance key (black, white) or chroma key. If chroma key is selected, use the KEY menu setting "COLOR" or "SAMPLING MARKER" to specify the color that is removed.	p. 14 p. 16
		Use the [CONTROL 1] [CONTROL 2] knobs to adjust the right amount of cutout for the logo or video.	
The video does not switch completely when you operate the video fader.	Depending on how long the V-02HD has been used, or on how it has been transported, the video might no longer switch completely.	Select the SYSTEM menu item "VIDEO FADER CALIBRATE," and follow the on-screen directions to calibrate (adjust) the video fader.	—
Audio-related Problems			
No audio is output. Audio volume is low.	Is the volume turned down on the V-02HD?	Adjust each input to the appropriate volume. Also raise the output volume. • Use AUDIO INPUT menu → "AUDIO IN 1"-"HDMI IN 2" → "INPUT LEVEL" to adjust each input volume. • Use AUDIO OUTPUT menu → "MASTER OUTPUT" → "MASTER OUTPUT LEVEL" to adjust the output volume.	p. 22
	Could the audio be muted?	Defeat mute (silence) for the input/output audio. • In AUDIO INPUT menu → "AUDIO IN 1"-"HDMI IN 2" → "set INPUT MUTE" to "OFF." • In AUDIO OUTPUT menu → "MASTER OUTPUT" → set "OUTPUT MUTE" to "OFF."	p. 27
Other Problems			
Buttons and knobs cannot be operated.	Could panel lock be enabled?	If the panel lock function which temporarily locks panel operations is enabled, the buttons and knobs will be inoperable. In SYSTEM menu → "PANEL LOCK" → PANEL LOCK menu, turn the button or knob lock "OFF" (disabled).	p. 36

Main Specifications

Video		
Video Processing	4:4:4 (Y/Pb/Pr), 10-bit	
Input Connectors	INPUT 1-2	HDMI type A x 2 * HDCP Supported * Multi-format Supported
Output Connectors	PROGRAM OUT	HDMI type A * HDCP Supported
	PREVIEW OUT	* Multi-format Supported
	USB STREAM	USB Type-C®
Input Formats	PROGRAM OUT	480/59.94i, 480/59.94p, 720/59.94p, 1080/59.94i, 1080/59.94p, 1080/60p, 1080/29.97p, 1080/30p *1 576/50i, 576/50p, 720/50p, 1080/50i, 1080/50p, 1080/25p *2 1080/23.98p, 1080/24p VGA (640 x 480/60 Hz), SVGA (800 x 600/60 Hz), XGA (1024 x 768/60 Hz) WXGA (1280 x 800/60 Hz), SXGA (1280 x 1024/60 Hz) FWXGA (1366 x 768/60 Hz), SXGA+ (1400 x 1050/60 Hz) UXGA (1600 x 1200/60 Hz), WUXGA (1920 x 1200/60 Hz)
	PREVIEW OUT	* The refresh rate is the maximum value of each resolution. * Conforms to CEA-861-E, VESA DMT Version 1.0 Revision 11. * 1920 x 1200/60 Hz: Reduced blanking * The input interlaced video signal is converted to progressive video signal by internal processing. * 1 FRAME RATE = 59.94 Hz * 2 FRAME RATE = 50 Hz
Output Formats	PROGRAM OUT	480/59.94p, 720/59.94p, 1080/59.94i, 1080/59.94p, 1080/29.97p *1 576/50p, 720/50p, 1080/50i, 1080/50p, 1080/25p *2 SVGA (800 x 600/60 Hz), XGA (1024 x 768/60 Hz) WXGA (1280 x 800/60 Hz), FWXGA (1366 x 768/60 Hz) SXGA (1280 x 1024/60 Hz), SXGA+ (1400 x 1050/60 Hz) UXGA (1600 x 1200/60 Hz), WUXGA (1920 x 1200/60 Hz) HD (1280 x 720/60 Hz), FHD (1920 x 1080/60 Hz)
	PREVIEW OUT	* Conforms to VESA DMT Version 1.0 Revision 11. * The output refresh rates of 800 x 600-1400 x 1050 are 75 Hz when the unit's frame rate setting is 50 Hz. * 1920 x 1200/60 Hz: Reduced blanking * 1 FRAME RATE = 59.94 Hz * 2 FRAME RATE = 50 Hz
	USB STREAM	1080/60p, 720/60p, 640 x 480/60p *1 1080/59.94p, 720/59.94p, 640 x 480/59.94p *2 1080/29.97p, 720/29.97p, 640 x 480/29.97p *3 1080/50p, 720/50p, 640 x 480/50p *4 1080/25p, 720/25p, 640 x 480/25p *5 * Uncompressed format (YUY2) and Compressed format (Motion JPEG) supported. * 1 FRAME RATE (USB OUT) = 60 Hz * 2 FRAME RATE (USB OUT) = 59.94 Hz * 3 FRAME RATE (USB OUT) = 29.97 Hz * 4 FRAME RATE (USB OUT) = 50 Hz * 5 FRAME RATE (USB OUT) = 25 Hz
Video Effects	Transition	CUT, MIX (DISSOLVE), WIPE (9 types)
	Composition	PinP (SQUARE, CIRCLE, DIAMOND), KEY (Luminance Key, Chroma Key)
	Visual Effects (14 types)	MOSAIC, WAVE, RGB REPLACE, COLORPASS, NEGATIVE, COLORIZE, POSTERIZE, SILHOUETTE, EMOSS FIND EDGES, MONOCOLOR, HUE OFFSET, SATURATION OFFSET, VALUE OFFSET
	Others	Flip horizontal, Flip vertical, Still Image Capture, Still Image Playback Output fade (Audio, Video: WHITE or BLACK), Test pattern output

■ Audio		
Audio Processing	Sample rate	24 bits/48 kHz
Audio Formats	Linear PCM, 24 bits/48 kHz, 2 ch	
Input Connectors (Analog)	AUDIO IN 1–2	Stereo miniature type x 2, plug-in power supported
Input Connectors (Digital)	USB STREAM	USB Type-C®
	INPUT 1–2	HDMI Type A x 2
Output Connectors (Analog)	PHONES	Stereo miniature type
Output Connectors (Digital)	PROGRAM OUT	HDMI type A
	PREVIEW OUT	
Input Level	AUDIO IN	-15 dBu (Maximum: +3 dBu)
Input Impedance	AUDIO IN	45 kΩ
Output Level	PHONES	92 mW + 92 mW (32 Ω)
Output Impedance	PHONES	10 Ω
Audio Effects	Delay, Reverb, High pass filter, Noise gate, De-esser, Compressor, Equalizer, Voice changer, Multi-band compressor, Limiter, Test tone output	
■ Others		
External Connectors	USB STREAM	USB Type-C® (for backup from PC, for remote control from PC and iPad)
	CTL/EXP	1/4-inch TRS phone type
Functions	Preset Memory (8 types), Panel lock function, EDID Emulator, Auto Switching, Auto Input Detect	
Power Supply	AC Adaptor	
Current Draw	1.4 A	
Power Consumption	12.6 W	
Operation Temperature	+0 to +40 degrees Celsius +32 to +104 degrees Fahrenheit	
Dimensions	160 (W) x 108 (D) x 51 (H) mm 6-5/16 (W) x 4-1/4 (D) x 2-1/16 (H) inches	
Weight (excluding AC adaptor)	0.6 kg 1 lbs 6 oz	
Accessories	Startup Guide, Leaflet "USING THE UNIT SAFELY", AC adaptor, Power cord, Cord hook	
Options (sold separately)	Footswitch	BOSS FS-5U, FS-6, FS-7
	Expression Pedal	EV-5, BOSS FV-500L, FV-500H

* 0 dBu=0.775 Vrms

* This document explains the specifications of the product at the time that the document was issued. For the latest information, refer to the Roland website.



- Roland is an either registered trademark or trademark of Roland Corporation in the United States and/or other countries.
- Company names and product names appearing in this document are registered trademarks or trademarks of their respective owners.