

# User installation guide

English | Nederlands | Deutsch | Français | Español | Italiano | 繁體中文 | 简体中文 | 日本語

## 2985-SX / 2995-SX Banknote Counter



# Introduction

---

Thank you for purchasing a Safescan 2985-SX / 2995-SX banknote counter. For proper use and maintenance we advise you to read this user manual carefully.

## Please note

---

Should the equipment be altered in any way or used in a manner for which it was not intended at the time of delivery, the supplier of the equipment accepts no responsibility for injury or damage to personnel or equipment. If the conditions for use of the equipment are changed, the supplier must be contacted or the declaration of conformity will be invalidated.

## Safety instructions

---

- Place the machine on a flat and stable surface.
- Do not place the machine in dusty or dirty environments.
- Use the supplied dust cover when the machine is not in use.
- Do not place the machine in direct sunlight or near heat sources or air conditioners.
- Always connect the device to a grounded power outlet.
- Use only the supplied power cord.
- Operation temperature 15-35 °C / 59-95 °F.
- Operation humidity 30-80% R.H.
- Do not use the machine outdoors.
- Do not expose the machine to liquids.
- This machine contains rotating parts. Never touch the moving parts when the machine is switched ON.
- Please ensure that no foreign objects (coins, paper clips, staples,) fall into the machine, these may block the mechanical parts and the sensors of the machine and damage or break them and will void your warranty.
- Keep jewellery, long hair, ties and other protruding parts away while operating the machine.
- Never disassemble the machine.
- To prevent shock hazard, do not touch the power cable with wet hands.
- Unplug the device if you want to move it to another position.
- Hold the plug when disconnecting the unit from the power outlet, never pull the cord.

## Product overview and box contents

### Front

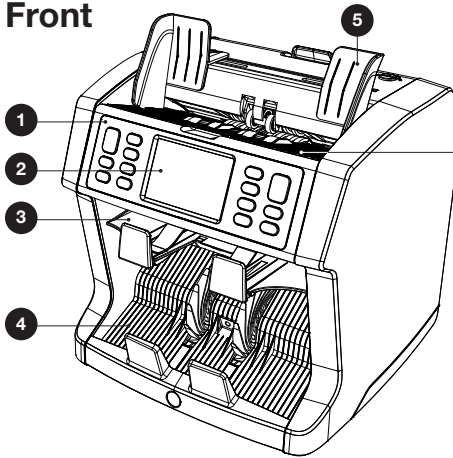

### Back

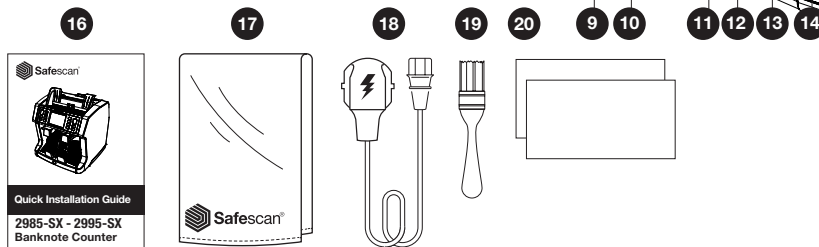
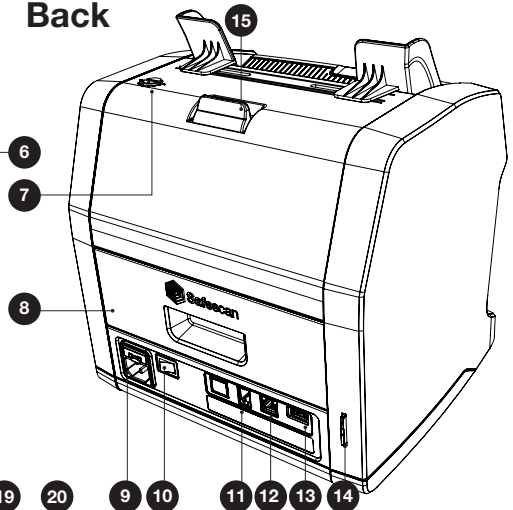

- |  |   |
|--|---|
| <ol style="list-style-type: none"> <li>1. Control panel</li> <li>2. LCD touch screen</li> <li>3. Reject pocket</li> <li>4. Stacker</li> <li>5. Banknote guides</li> <li>6. Hopper</li> <li>7. Feeding gap adjusting knob</li> <li>8. Back panel</li> <li>9. Power connector</li> <li>10. Power switch</li> </ol> | <ol style="list-style-type: none"> <li>11. Printer connector / MCS software cable connector</li> <li>12. External display connector (RJ-12)</li> <li>13. Update port (USB-A)</li> <li>14. SD-card slot</li> <li>15. Lever for opening top panel</li> <li>16. Manual</li> <li>17. Dust cover</li> <li>18. Mains cable</li> <li>19. Cleaning brush</li> <li>20. 2x Cleaning sheets</li> </ol> |
|--|---|

## Setting up your machine

1. Remove the protective foil from the LCD screen.
2. Connect the power cable to the power outlet.
3. Power on the device with the power switch.
4. The banknote counter will start. Select a language by pressing the touch screen and confirm the language selection in the next screen.
5. The device will perform a self test, during which its software version and product number will be displayed. After a successful self-test, the machine will open the count screen and is ready to use.

# Buttons & touch display

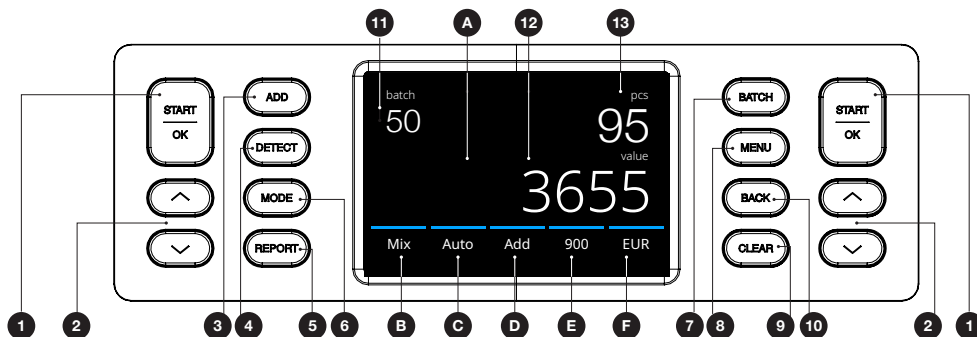

Nr.	Button	Description
1.	[START/OK]	Start counting / Confirm selection. In Menu: Open/confirm selection.
2.	[UP/DOWN]	(In Menu) Go to next/previous menu item. Long press: Go to next menu page.
3.	[ADD]	Add function On/Off (ADD count results of multiple counts to the total.)
4.	[DETECT]	Open detection menu. (Select currency/detection type)
5.	[REPORT]	Open counting results report and print interface.
6.	[MODE]	Open Count mode menu.
7.	[BATCH]	Open Batch menu. (In BATCH menu: Loop: 100 - 50 - 25 - 20 - 10 - Off)
8.	[MENU]	Open the settings menu.
9.	[CLEAR]	Clear counting results.
10.	[BACK]	(In Menu) Back to count screen.

## Touch buttons

A.	Open Quick menu
B.	Open Count mode menu
C.	Automatic start counting On/Off
D.	Add function On/Off
E.	Open counting speed menu
F.	Open detection type menu

## Screen elements

11.	batch	Selected batch number
12.	value	Total value of counted banknotes
13.	pcs	Number of counted notes

# First operation

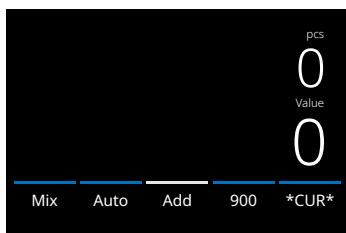

## 2985-SX

- The device starts by default with the following settings:
  - Detection type: **\*CUR\*** (Automatic currency recognition)
  - Counting mode: **Mix**
  - Auto start: **ON**
  - Add mode: **Off**
  - Counting speed: 900

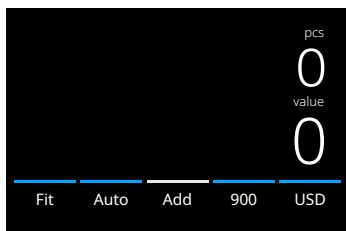

## 2995-SX

- The device starts by default with the following settings:
  - Detection type: **USD\***
  - Counting mode: **Fit**
  - Auto start: **ON**
  - Add mode: **Off**
  - Counting speed: **900**

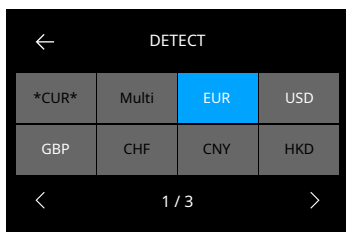

- \* If you would like to count another currency, press the **DETECT** button or press USD on the screen to open the **DETECT** menu.

**Note:** Only currencies displayed in white text are available for fitness counting.

Selecting a currency which is not available for fitness counting (black text) will change the counting mode from Fitness to Mix counting.

Please visit [www.safescan.com](http://www.safescan.com) to check for currency updates.

- Prevent unnecessary counting errors. Set the banknote hopper guide so that the sides of the banknotes are enclosed and therefore the banknotes are centered. Organise your banknotes in a neat stack, make sure the back of the stack is aligned straight and the notes are centered.

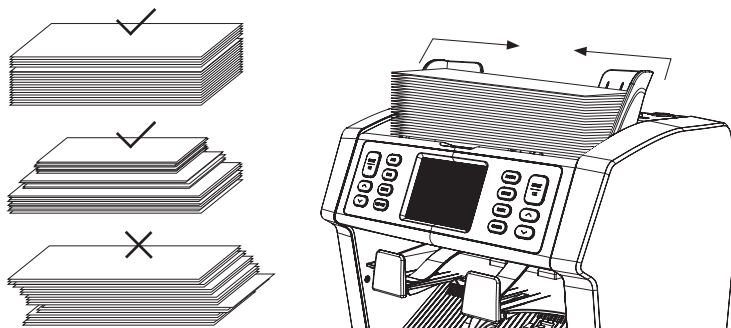

- When the banknotes are placed on the hopper the machine will automatically start counting. Press **[AUTO]** on the screen to switch Off this function. If **AUTO** is switched off, press **[START/OK]** to start counting.

4. When the device detects a suspect banknote during counting, it will transport this note to the reject pocket. The device will sound an alarm and the blue coloured lines in the display will turn red.

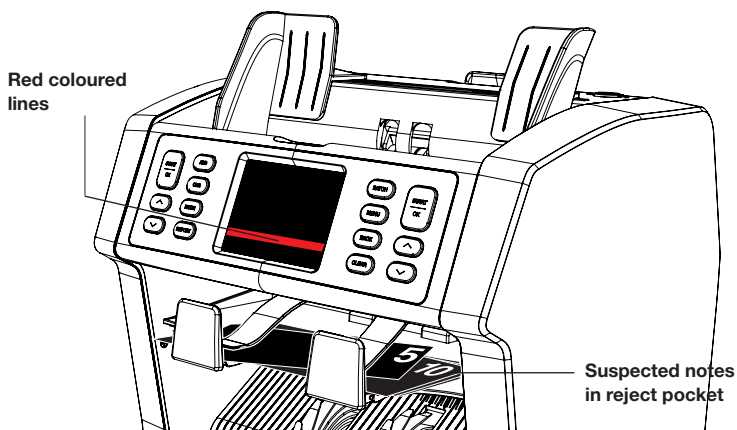

5. After the count has finished, the results are shown on the screen.

#### 2985-SX

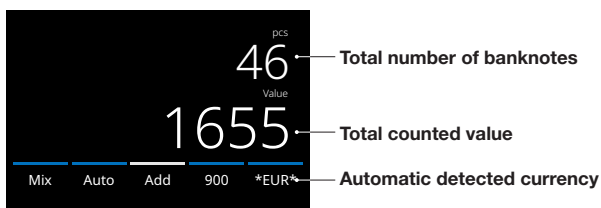

#### 2995-SX

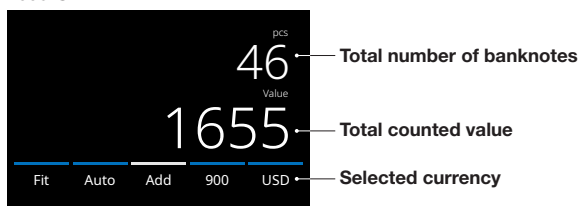

6. Press the **[REPORT]** button to view the detailed counting results specified per denomination. Press **[PRINT]** on the screen to print the counting results\*.

Den	Pcs	Value
5	23	115
10	16	160
20	21	420
50	17	850
<b>Total</b>	<b>93</b>	<b>1.545</b>

Press to print\*

\* Safescan TP-230 printer separately available

## Selecting a currency/detection type

- To select or change the current detection type press the button in the bottom right corner of the touch screen or press the **[DETECT]** button on the control panel. The detection menu opens.

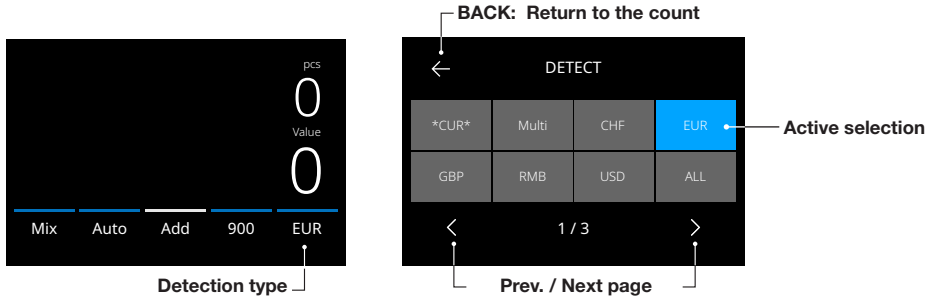

- The detect menu contains multiple selection tiles. The active detection type has a blue coloured tile. Use **[LEFT]** & **[RIGHT]** buttons to toggle between the detect menu pages. Simply press the tile corresponding to the currency or the detection manner you require for your count.

**Note:** Selecting a detection type will determine the available count modes.

## Explanation of the available detection types

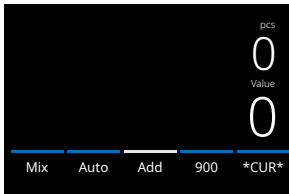
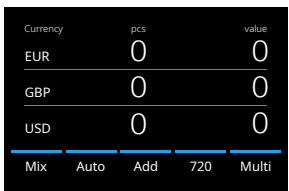
Detection	Description	Explanation of usage
<p><b>*CUR*</b></p> 	Counting banknotes with automatic recognition of currencies.	<p>With <b>*CUR*</b> selected there is no need to manually select the currency before counting. Simply place currencies on the machine. The first detected currency will automatically be selected as the active currency of the count.</p> <p>* Not available for fitness count mode (Fit).</p>
<p><b>Multi</b></p> 	Mix counting the amount and value of 3 preselected currencies simultaneously.	<p>Counting the amount and value of 3 mixed currencies during the same count. Place banknotes of the preselected currencies on the device. The results will be shown on the screen.</p> <p>Preselections of currencies can be done in the device settings menu.</p>

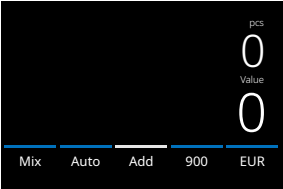
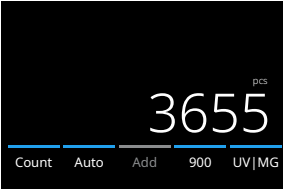

Detection	Description	Explanation of usage
EUR, USD, GBP and other currencies that are available on the device.	Counting only banknotes of one specific currency.	Select currencies in the DETECT menu. Banknotes of other currencies will be considered as suspect and transported to the reject pocket.
		
ALL	Sheet counting without any counterfeit detection.	Select ALL, UV, MG, UV+MG to sheet count currencies which are not available on the machine.
UV	Sheet counting with UV detection.	Only the number of counted notes will be shown on the screen.
MG	Sheet counting with MG detection.	
UV   MG	Sheet counting with both UV + MG detection.	
		



# Selecting a counting mode

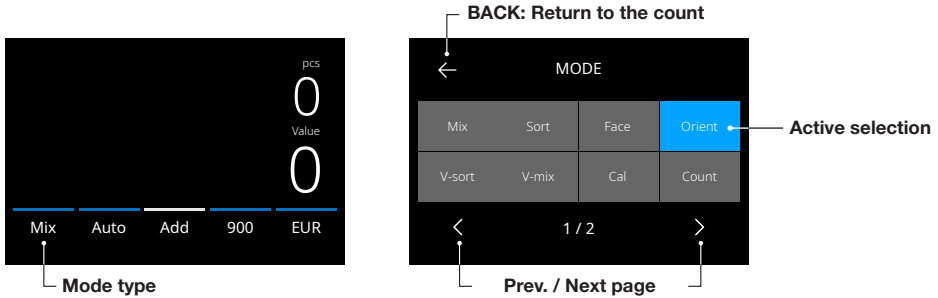



1. Press the mode type in the bottom left corner of the screen or press the **[MODE]** button on the control panel. The mode menu opens.

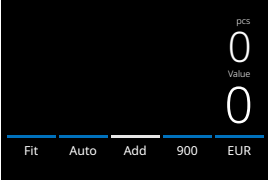
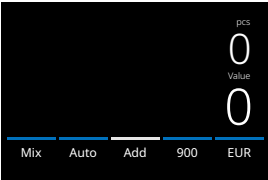

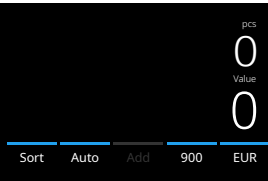
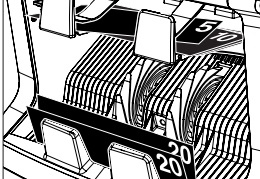
2. The mode menu contains multiple selection tiles. The active mode type has a blue coloured tile. The available mode types are determined by the active detection type. Simply press the mode type you require for your count.

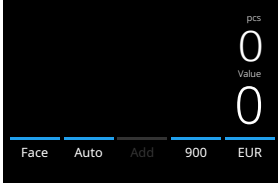
## Explanation of the available count modes

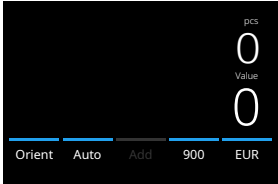
Mode	Main feature	Explanation of mode
<b>Fit</b> 	Fitness counting of unsorted banknotes.	Value counting of banknotes while performing a fitness check. "Un-fit" banknotes will be transported to the reject pocket. The reason of rejection can be viewed in the Report menu. Note: Fitness checking is not available for all currencies on the device. Please visit <a href="http://www.safescan.com">www.safescan.com</a> for currency updates.
<b>Mix</b>  	Value counting of unsorted banknotes.	Counting the value and number of both sorted and unsorted denominations of the selected currency. If detection "MULTI" is selected, 3 currencies can be mixed counted simultaneously.
<b>Sort</b>  	Sort banknotes per denomination.	Counting the number and value of banknotes sorted per denomination. Denominations different than the first counted banknote denominations are rejected.

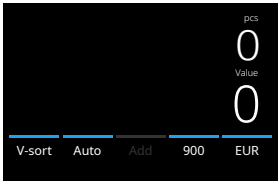
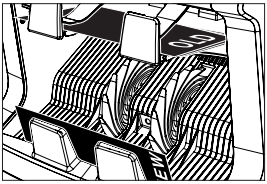
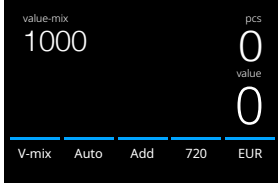
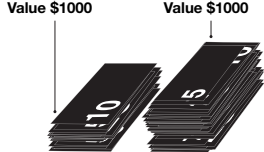
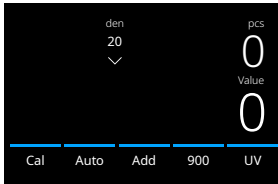
Mode	Main feature	Explanation of mode
<b>Face</b> 	Sort banknotes per face side. 	Counting the value and quantity of banknotes sorted per face side and denomination. Banknotes with a different face side or denomination than the first counted banknote are transported to the reject pocket.
<b>Orient</b> 	Sort banknotes per orientation. 	Counting the value and quantity of banknotes sorted per orientation and denomination. Banknotes with a different orientation or denomination than the first counted banknote are transported to the reject pocket.
<b>V-sort (version sort)</b> 	Sort banknotes per denomination version (Old / New) 	Counting the value and quantity of banknotes sorted per denomination version (divide old and new versions). Banknotes with a different denomination version than the first counted banknote are transported to the reject pocket.
<b>V-mix (value mix)</b> 	Count banknotes in batches of a preset value. 	Manually set a desired value. The machine counts banknotes until the desired value is reached. Banknotes not useful in reaching the desired value will be transported to the reject pocket.  <b>Note:</b> This function is only available after selecting 1 currency form the detect menu.
<b>CAL</b> 	Counting the value and number of currencies which are not available on the device.	Select the value of the denomination you are planning to count. The device will automatically multiply this piece-value to the number of counted sheets to determine the value.  <b>Note:</b> The device will not filter out different denominations.

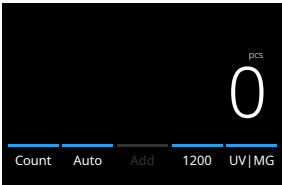
Mode	Main feature	Explanation of mode
<b>Count</b> 	Counting the number of banknotes.	Counting the number of banknotes without checking banknote dimensions or value.

## Add function

Use the add function to add the results of multiple counts to the total. Press **[ADD]** in the bottom-middle of the count screen, or press the **[ADD]** button on the control panel. The bar above ADD will light up blue when activated.

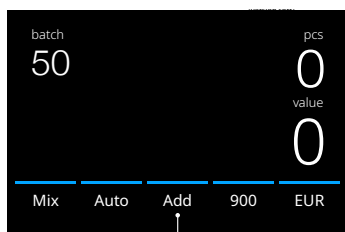

Press to activate ADD

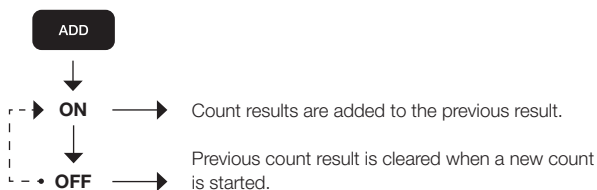

## Batch counting

The batch function is used to create stacks of an equal number of banknotes.

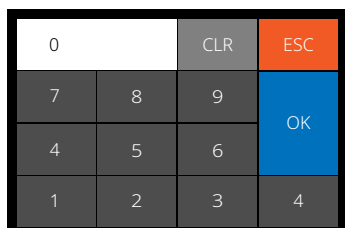

Press **[BATCH]** to open the Batch entry screen. By default the batch number is set to 100.

1. Type the desired batch number on the touch screen and press **[OK]** to confirm. Or repeatedly press the **[BATCH]** button to toggle between the presetted batch numbers.
  - Press **[CLR]** to clear the entry.
  - Press **[ESC]** on the touch screen to exit the batch entry screen.

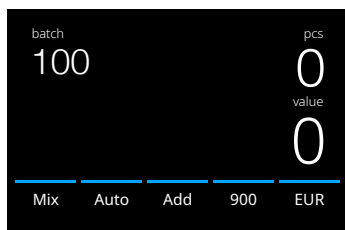

2. In the count screen, the batch number is shown.  
Note: The batch function is not available in "Value-Mix" mode.
3. Place a stack of banknotes on the hopper. The device will now stop counting when the batch number has been reached.

**Note:** When the batch number is not reached the device will sound one audio signal.

## Select counting speed

Press the count speed indication on the touch-screen to open the Speed menu. The speed menu will show the count speeds available within the selected counting mode and detection setting.

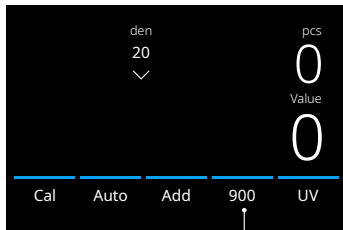

Press to open The Speed menu

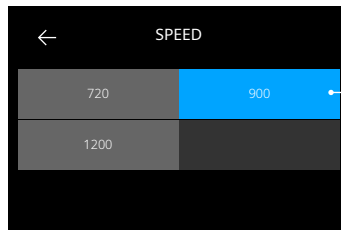

Current count speed

## Automatic count start

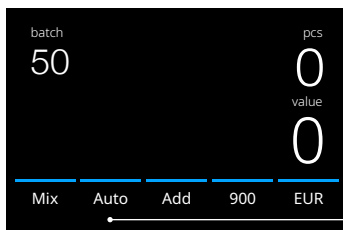

With setting 'Auto' is activated the machine will automatically start count when banknotes are placed on the hopper. With Auto deactivated, the **[START/OK]** button must be pressed to start counting.

Press to activate 'Auto'matic count start

## Counting report

Use the report screen to show the counting results of currency counting. If counting mode 'Multi' is selected count mode the results of 3 currencies will be separately displayed in the count report.

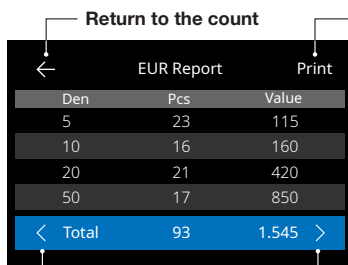

1. After finishing a count, press **[REPORT]** to view the counting results.
2. The report screen shows the amount and value per denomination and the total value.
3. Press **->** to scroll through the next result page(s)
4. Press **'Print' \*** to send the count results to a printer.
5. Press **<-** to exit the report screen and return to the count screen.

\* Printing can be done with the optional Safescan TP-230 printer.

## Detecting suspect banknotes

All detected suspect banknotes are transported to the reject pocket. If a suspect banknote is detected, the blue coloured lines in the screen will become red.

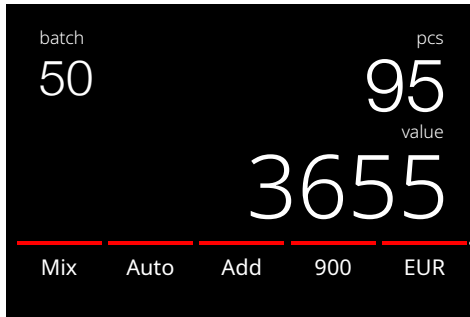

Lines change from blue to red after detecting a suspect banknote

After finishing the count (when the hopper is empty), the device will repeatedly make 3 beep tones and the lines remain red. After removing all the banknotes from the reject pocket, the red line will return to the colour blue.

To inspect the reason for rejecting the banknote, press **[REPORT]** and toggle with **[< >]** to the Reject list. Alternatively use the **[UP DOWN]** buttons to scroll through the list. Inspect the suspect banknote and count it again to verify its authenticity.

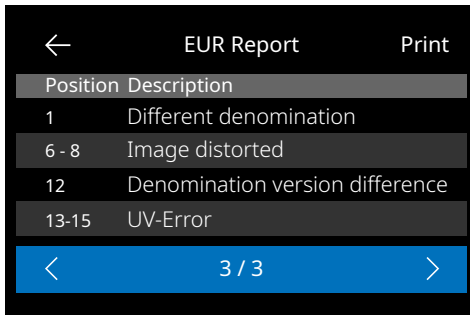

1. The number on the left-hand side of the screen indicates the location of the banknotes: Number 1 is the first banknote that has been transported to the reject pocket.
2. If multiple banknotes are transported to the reject pocket, the number 1 banknote is located at the bottom of the stack.
3. The reason for rejection is shown on the right hand side.

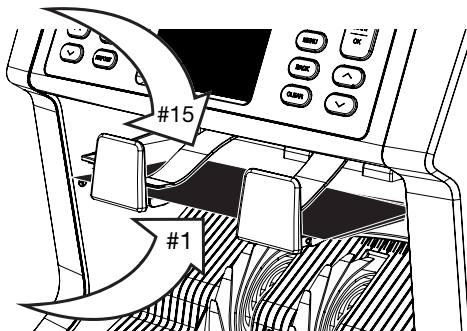

## Error messages

When the device detects an issue with a banknote during counting, it will stop, sound an alarm and display an error message. Read the message and follow the instructions to solve the problem.

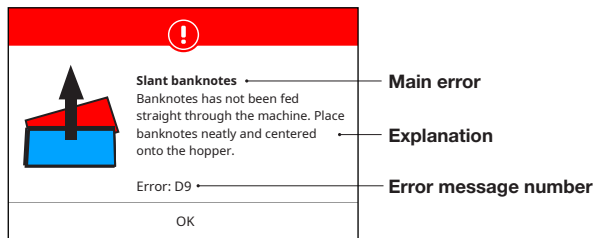

A variety of messages can be displayed. These messages can occur during start up or during counting. The error message screen shows the main error, the explanation and solution and the error message number.

## List of rejection and error messages

Error	Cause	Solution(s)
<b>UV, MG, IR, IMAGE INCOMPLETE, IMAGE DISTORTION, NOT RECOGNIZED</b>	<ul style="list-style-type: none"> <li>- Banknote is suspect.</li> <li>- The sensors may be dirty or blocked by dust.</li> <li>- The image or integrated UV &amp; IR features of banknotes may become weaker when a banknote is old, heavily used or when it has accidentally been washed.</li> </ul>	<ul style="list-style-type: none"> <li>- Count the banknote again to make sure if a suspected banknote is detected.</li> <li>- Follow the cleaning procedure.</li> <li>- Check if the banknotes are dirty, damaged or worn out.</li> <li>- Make sure that the device is not in the vicinity of any magnetic fields or devices transmitting any signal since this may disrupt the integrated sensors.</li> </ul>
<b>DIFFERENT DENOMINATION</b>	<ul style="list-style-type: none"> <li>- A banknote of a different denomination than the first counted banknote has been detected.</li> </ul>	<ul style="list-style-type: none"> <li>- Check the rejected stack for a different denomination.</li> </ul>
<b>SLANT</b>	<ul style="list-style-type: none"> <li>- The banknotes are not being fed straight through the machine.</li> </ul>	<ul style="list-style-type: none"> <li>- Ensure the banknotes are placed neatly and are inserted centred on the hopper.</li> <li>- Use the hopper guides to center the banknotes and when counting a large stack of banknotes, guide the notes also with your hands during counting. Please refer to first operation.</li> <li>- The hopper may be set too loose. Adjust the hopper knob in clockwise direction. See chapter maintenance and servicing.</li> </ul>
<b>CHAINED, DOUBLE</b>	<ul style="list-style-type: none"> <li>- More than one banknote is being fed through the machine at the same time.</li> </ul>	<ul style="list-style-type: none"> <li>- Ensure that there are no banknotes stuck, folded or glued together.</li> <li>- Check the banknote quality. If no obvious visible issues are found, count the banknote again and check if the problem persists.</li> <li>- The hopper may be set too loose. Adjust the hopper knob in clockwise direction. See chapter maintenance and servicing.</li> </ul>

## Error messages

---

<b>HALF BANKNOTE</b>	- An incomplete, torn or half-size banknote has been detected.	- Check the banknote quality. If no obvious visible issues are found, count the banknote again and check if the problem persists.
<b>WIDTH, LENGTH</b>	- A banknote with a non-conforming size has been detected.	- Check the banknote quality. If no obvious visible issues are found, count the banknote again and check if the problem persists.
<b>JAM</b>	- Banknotes are jammed.	- Remove jammed banknotes. Open top or back panel when needed to solve the jam.

## MACHINE ERROR MESSAGES

---

<b>Error message displayed</b>	<b>Solution displayed</b>
Machine error	Please restart the device
Machine service error	Contact Safescan support: <a href="https://support.safescan.com">support.safescan.com</a>
The stacker is full	Remove all banknotes from the stacker
Top panel is open	Close the top panel
The back panel is open	Close the back panel
Hopper sensor blocked	Remove banknotes and clear dust from the hopper sensor.
Stacker sensors are blocked	Remove all banknotes from the stacker and clear dust from the stacker.



## Quick menu

The quick menu is a helpful tool that offers several features which are used regularly.

Open the quick menu by simply pressing the middle of the touch screen once. With the quick menu opened, press a feature on the screen or press **[ESC]** to exit the quick menu.

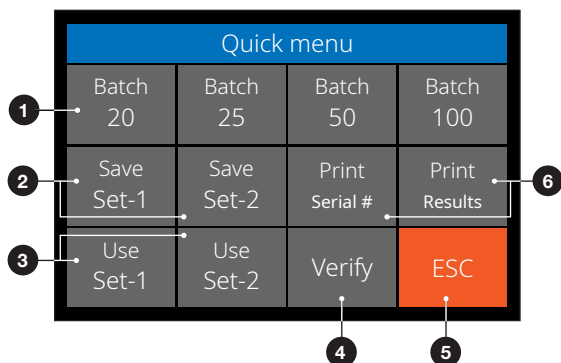

Nr.	On the screen	Description	Usage
1.	Batch 20/25/50/100	Batch presets.	<p>Instruction</p> <ol style="list-style-type: none"> <li>1. Press the touch screen once to open the quick menu.</li> <li>2. Press a batch setting.</li> <li>3. The machine will return to the count screen with the selected batch settings activated.</li> </ol> <p><b>Note:</b> Batch presets can be adjusted in counting preferences in the menu.</p>
2.	Save Set-1 & Set-2	Save counting settings as currently indicated on the machine.	<p>If certain specific counting settings are often used, it can be useful to save them on the machine. With this option, the currency, batch number, counting mode and add feature state, can be saved under Set-1 or Set-2.</p> <p>Instruction</p> <ol style="list-style-type: none"> <li>1. Set the machine to the preferred settings.</li> <li>2. Press the touch screen once to open the quick menu.</li> <li>3. Press [Save Set-1 or Set-2].</li> <li>4. The machine saves the current settings and returns to the quick menu.</li> <li>5. Press <b>[ESC]</b> to exit the quick menu.</li> </ol> <p><b>Note:</b> Settings can always be saved. Every time the [Save Set-1 or Set-2] is pressed, the current settings will overwrite previous saved settings.</p>

# Quick menu

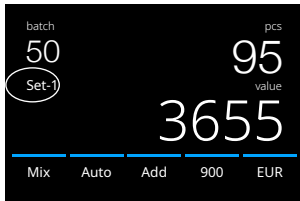
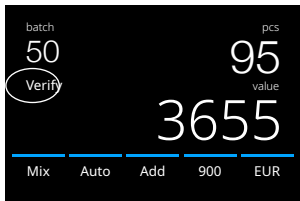
Nr.	On the screen	Description	Usage
3.	Use Set-1 & Set-2	Use saved counting settings.	<p>Instruction</p> <ol style="list-style-type: none"> <li>1. Press the touch screen once to open the quick menu.</li> <li>2. Press [Use Set-1 or Set-2].</li> <li>3. The count menu opens using the saved settings. On the screen, the active indication Set-1 or /Set-2 icon appears.</li> </ol> <p><b>Note:</b> Changing the settings will directly disable the Use Set-1 or Set-2. The indication icon will disappear from the screen.</p>
			
4.	Verify	Open verify count function.	<p>This function can be used to recount and check any count suspected of being wrong without adding to current batch or day totals.</p> <ol style="list-style-type: none"> <li>1. Press the touchscreen once to open the quick menu.</li> <li>2. Press [<b>Verify</b>].</li> <li>3. The count menu opens with the current used settings. All totals of the previous count are stored in memory. On the screen, the 'Verify' indication appears.</li> <li>4. Perform 1 or more verify counts.</li> <li>5. To exit the verify mode, press the touchscreen once and press [<b>Verify</b>].</li> <li>6. The machine will return to the saved count results of your previous counts.</li> </ol>
			
5.	ESC	Exit Quick Menu.	<p>Instruction</p> <ol style="list-style-type: none"> <li>1. Press [<b>ESC</b>].</li> <li>2. The machine will return to the count screen.</li> </ol>
6.	Print  (Print Serial# if available)	<p>Print current count results.</p> <p>Export count results to the Money Counting Software</p>	<p><b>Note:</b> For printing the count results you'll need the optional Safescan TP-230 printer.</p> <p><b>Note:</b> Safescan Money Counting Software requires the use of the Safescan MCS cable.</p>

# Menu

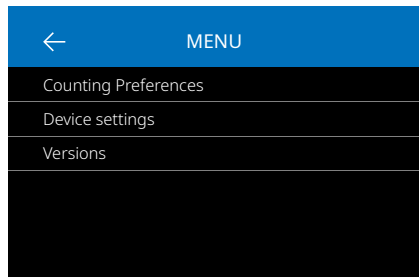

1. Press the **[MENU]** button to open the menu.
2. The menu is divided in 3 sub menu's.
  - Counting preferences
  - Device settings
  - Versions
3. Press on a sub menu item to open or Press [**<-**] to return to the count menu.

## Working with the menu

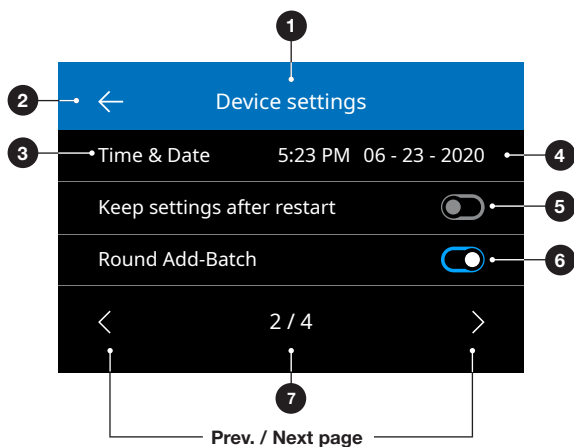

1. Current Menu/Sub menu
2. Go one level back
3. Menu item
4. Item settings
5. Function switch OFF: Switch is grey
6. Function switch ON: Switch is bright white and blue.
7. Page number indication

# Menu items

Counting preference	Setting description
Serial number scanning	Enable or disable serialnumber scanning. Serialnumbers can be printed*.
Button sound	Enable or disable beep sounds when a button is pressed using the On/Off switch.
Alarm sound	Enable or disable alarm sounds when an error occurs using the On/Off switch.
Batch quantities	Change preset batch numbers in quick menu.
Currency status	Activate and deactivate currencies. Deactivated currencies will not appear during usage.
Device settings	Setting description
Language	Select language of user interface.
Multi mix currency selection	Select 3 currencies to use in the multi-currency mode.
Fitness currency selection	Select 3 currencies to use for fitness counting.
Time format	Select 12 or 24 hour format.
Time and Date	Menu to manually enter the time and date. The current time and date is shown.
Keep setting after restart	Enabled (On): The current user settings will be used after restarting. Disabled (Off): The device will start with automatic currency detection, count mode Mix and Batch Off.
Round Add-Batch	With both this function and ADD mode activated (On), the device will only add the count result of completed batches to the total. When the batch number isn't reached, the machine will 'correct' the total to the first multiple of the set batch amount.
CAL denominations	Select range for calculator mode: 1 - 1000 or 500 - 100.000
Reject pocket capacity	Select the maximum capacity of: 20, 30, 40 or 50 banknotes
Default factory settings	Start reset procedure. After resetting, the device is set to default factory settings. All user settings are cleared.
Versions	Setting description
Firmware version	Shows which firmware version is installed.
Currency version	Shows which currency software version is installed.

\* Printing can be done on the optional Safescan TP-230 printer. Serialnumber scanning may not be available for all currencies.

## Maintenance & servicing

---

To ensure continuous reliable operation, regular cleaning of the device's internal parts and sensors is required. Dust or dirt can rub off banknotes and disturb the proper functioning of the sensors. Also in case of jam errors, it might be necessary to open the top panel to remove jammed banknotes.

**Remark:** Always power OFF the machine and pull out the power cable from the device before servicing.

### Opening the top panel and back panel

---

To ensure continuous reliable operation, regular cleaning of the device's internal parts and sensors is required. Dust or dirt can rub off banknotes and disturb the proper functioning of the sensors. Also in case of jam errors, it might be necessary to open the top panel to remove jammed banknotes.

**Remark:** Always power OFF the machine and pull out the power cable from the machine before opening the top panel and back panel.

**Note:** The back panel can only be removed or placed back when the top panel is opened first!

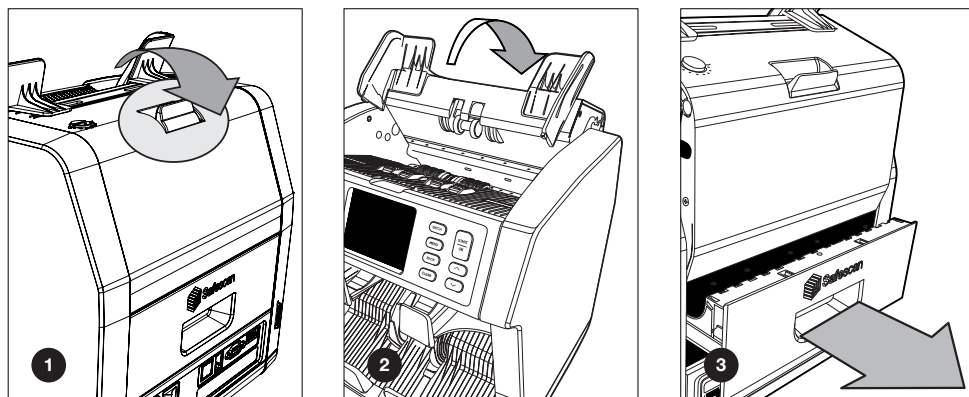

### Cleaning program

---

Weekly/monthly remove all dust from the sensors with a dry brush (included) or cloth. During cleaning the use of an airduster or vacuum cleaner is recommended. When using a vacuum cleaner make sure to put a soft brush attachment onto the hose.

The device will automatically give maintenance advise. Please make sure to clean the device as advised.

## Maintenance & servicing

### Cleaning the device and sensors

1. Use the enclosed cleaning aids (brush and cleaning sheets) for servicing the 2985-SX.
  - A. Start with brushing the top and bottom surface until all visible dust is removed.
  - B. Use the soft side of a cleaning sheet to wipe all further dust from the top and bottom surface, the sensors and rotation wheels.

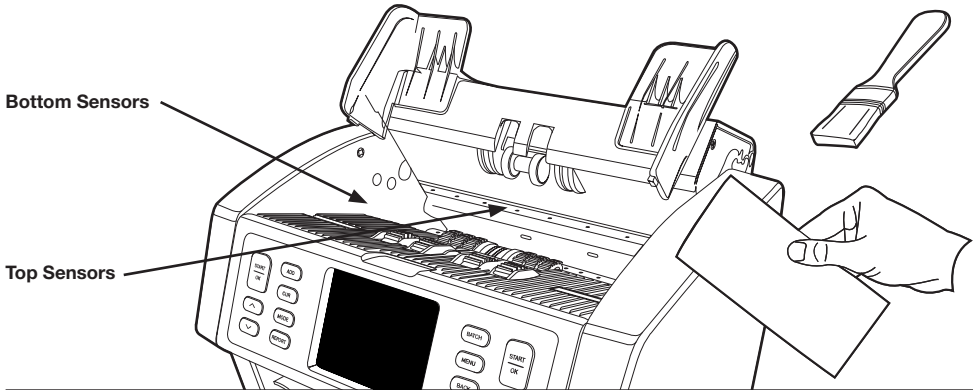

2. Pull out the back panel completely and clean as instructed. Clean the inside of the machine as well. When done, you must close the panels in reverse order: Back panel > Top panel.

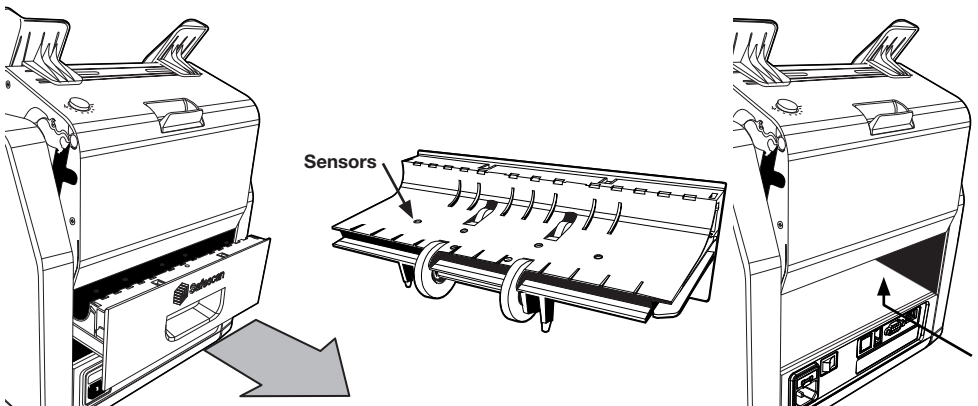

## Adjusting the feeding gap

When counting errors such as double notes, chained or slant notes occur frequently, or when banknotes are not being fed smoothly through the machine, it may be necessary to adjust the hopper adjusting knob. In the factory, the position of the hopper adjusting knob is set optimal. However, due to the nature of some banknotes, an adjustment may be required to ensure optimal feeding.

- When the banknotes are not being counted smoothly: increase the note thickness distance by turning the adjusting knob clockwise (+).
- When counting errors such as 'double notes' or 'chained notes/double notes' occur often, decrease the note thickness distance by turning the adjusting knob anti-clockwise (-).

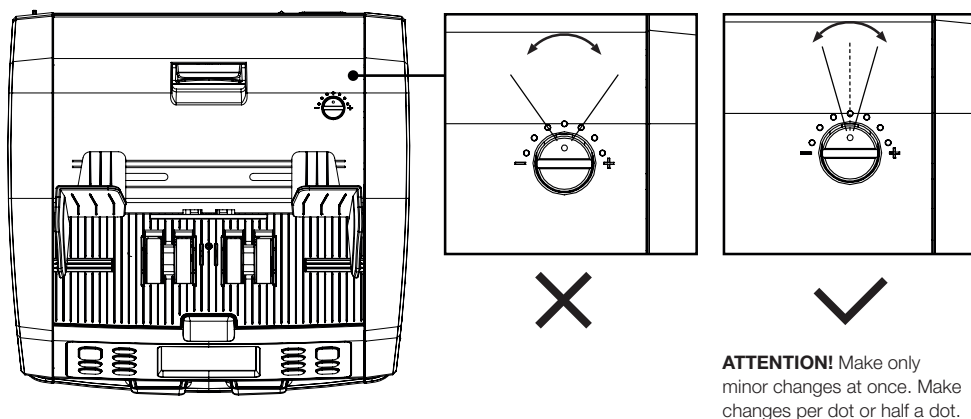

## Use in combination with safescan money counting software

The Safescan 2985-SX series can be used in combination with the Safescan Money Counting Software. Visit: [www.safescan.com/downloads](http://www.safescan.com/downloads). This enables you to export your counting results and serial number information to the PC for further processing.

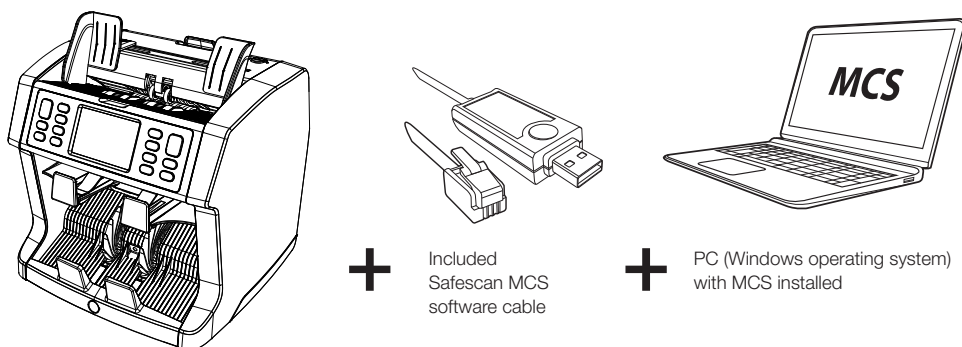

## Software updates

---

Central banks are constantly updating their banknotes to incorporate the newest security features and make it even harder for counterfeiters to succeed. Safescan's dedicated currency management team will make sure your Safescan 2985-SX banknote counter can keep pace with these changes.

All Safescan devices are tested yearly at the Central Banks. To make sure your machine is up to date, please check our website regularly to see if there are updates available and needed for your device.

## Updating the device

---

1. Check the currency software version on your machine. The soft/firmware versions are displayed in the Menu. Press **[MENU]** and then press 'Versions' to see the current versions.
2. Go to [www.safescan.com/downloads](http://www.safescan.com/downloads).
3. Fill in the category, product and part number. The latest software updates version will be shown.
4. Compare the version numbers and details to see if a software update is necessary.
5. If a software update is required: Download the software package and follow the included update procedure instructions.



## Technical Specifications

<b>Supported currencies:</b>	Regional currency packs (European, Asian, American and Middle Eastern available online. Please visit <a href="http://www.safescan.com">www.safescan.com</a> for up to date availability.
<b>Counting modes:</b>	<p><b>Fit</b> (Value counting with banknote fitness function)</p> <p><b>Mix</b> (Value counting for sorted &amp; unsorted currencies)</p> <p><b>Sort</b> (Value counting with denomination sorting or sheets counting with size-sorting and detection (None, UV, MG or UV + MG))</p> <p><b>Face</b> (Sort banknotes per face side.)</p> <p><b>Orient</b> (Sort banknotes per orientation.)</p> <p><b>V-sort</b> (Sort banknotes per denomination version (Old / New))</p> <p><b>V-mix</b> (Count banknotes in batches of a preset value.)</p> <p><b>Count</b> (Sheet count, with detection settings : Off, UV, MG or UV + MG)</p>
<b>Serial number scanning</b>	Yes
<b>Fitness sorting function</b>	2985-SX: No, 2995-SX: Yes
<b>Counting speed:</b>	720, 900 and 1.200 banknotes/minute
<b>Banknote feature detection:</b>	UV, MG, MT, IR, Image, 3D-size, Thickness, Paper Quality
<b>Banknote size range:</b>	50 x 110 mm ~ 90 x 180 mm
<b>Hopper capacity:</b>	500 banknotes
<b>Stacker capacity:</b>	220 banknotes
<b>Power:</b>	AC 100-240V / 50-60Hz.
<b>Power consumption:</b>	60W maximum
<b>Dimensions:</b>	(W x D x H) 259 x 254 x 255 mm
<b>Weight:</b>	9.2 kg
<b>Operating Temperature:</b>	15-35 °C / 59-95 °F.

## Technical Support

Please visit our online support center first - go to [support.safescan.com](http://support.safescan.com) and select 'Banknote Counters'.

If you need any further assistance: our support team is available by phone during office hours (GMT +1 timezone) or by e-mail to answer any question you may have regarding the usage of your Safescan device. Visit [www.safescan.com](http://www.safescan.com) for details.

When calling or e-mailing our support center, always make sure you have the following information at hand: model number, serial number (see product sticker at the bottom of the device), software version number (shown at startup of the device) and date of purchase.

Serial number



Software version number

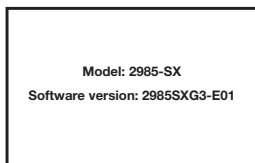

## 3 year warranty

Warranty procedure: [www.safescan.com](http://www.safescan.com)



This product is in compliance with the essential requirements and other relevant provisions of the applicable European directives. The Declaration of Conformity (DoC) is available at [www.safescan.com](http://www.safescan.com)



Take the device to a recycling centre if you want to dispose of it. Never dispose of any electronic devices with household waste.

**Safescan**<sup>®</sup>

---

**Safescan B.V.**  
PO Box 7067, 2701AB Zoetermeer, NL  
Designed in Europe - Made in China  
[www.safescan.com](http://www.safescan.com)  
© 2021 Safescan. All rights reserved  
SAFESCAN® is a registered trademark

---

[www.safescan.com](http://www.safescan.com)

21.2