

Quick Start Guide

Smart Wire-Free Security Camera

01 / Charge the Battery

The battery comes partially charged. We recommend that you fully charge the battery before use. This will take about **five and a half** hours with the included charger.

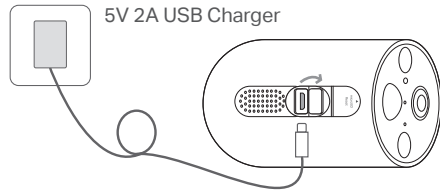

Note:

1. Peel off film from the camera before use.
2. Warning: Do not tear off the silicone part by force as it may affect the waterproof performance.
3. When you plug in the USB charger, the LED should blink amber quickly for 3 seconds. If not, make sure the power is running and check your connection.
4. Charge the battery using the USB cable and charger included in the package. Inappropriate cables may result in slow charging or failure to charge.
5. Keep the ports firmly covered when not in use to ensure waterproof performance.
6. Check the battery status in the Tapo app after setup.

*Images may differ from actual products.
©2023 TP-Link 7106510442 REV1.2.0

02 / Set Up the Camera

1. Get the **Tapo** app from the App Store or Google Play.



2. Press and hold **⏻** on your camera for about 3 seconds to turn it on. Then follow the instructions in the Tapo app to set up your camera.

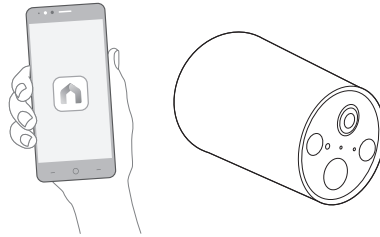

03 / Mounting Tips

1. Avoid placing behind glass. Glass will obstruct the motion sensor of your camera.
2. Choose a proper location to mount your camera, or it will be triggered too often by false alarms.
 - Avoid pointing the camera directly at swaying trees.
 - Avoid pointing the camera directly at vehicles and pedestrians on the road.
 - Avoid pointing the camera directly at street lamps and sunlight.
3. Mount your camera to the side so that movement goes across the lens's field of view to better trigger motion detection.

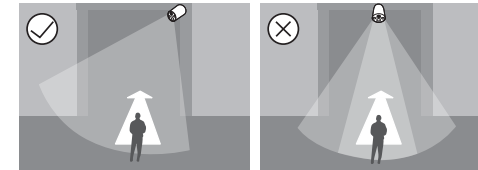

*Do not mount facing the direction of movement.

4. Tilt the camera downwards at an angle of about 20°.

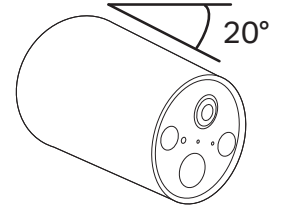

5. Do not place the camera upside down.
6. Keep the motion sensor level for best results.

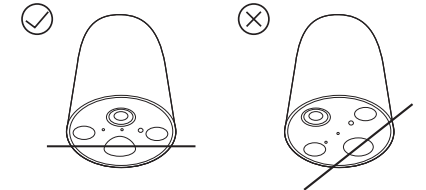

04 / Mount the Camera (Get detailed mounting instructions in the Tapo app.)

Option 1: Mount to metallic surfaces

The camera has a magnet in its base, allowing magnetic attachment to metallic surfaces.

CAUTION
Strong Magnet. Crushing Hazard.

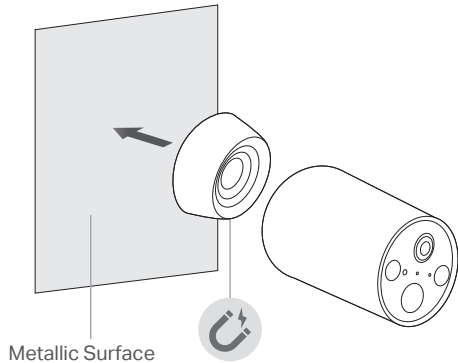

Option 2: Stick to a clean wall

1. Attach the included adhesive to the back of the metal plate properly.
Note: The adhesive is for one-time use. Avoid re-using the adhesive to ensure its adhesion.

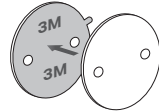

2. Wipe off the dust from the surface, stick the metal plate with the adhesive to the clean wall, and press it down for 15 seconds to ensure the plate is firmly attached. Then attach the camera to the plate.

Note: This is applicable with tile, glass, marble, metal, stainless steel, and hard wall surfaces. Sticking to other surfaces may result in damage from falling off.

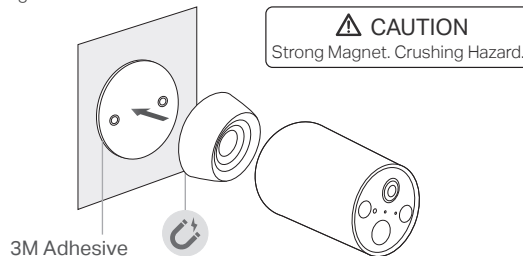

CAUTION
Strong Magnet. Crushing Hazard.

Option 3. Mount to a wall

1. Stick the mounting template to a desired mounting place. Drill two holes according to the template.

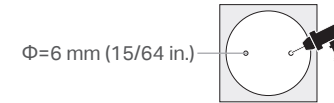

2. Insert two anchors into the holes and use the screws to affix the metal plate over the anchors. Then attach the camera to the plate.

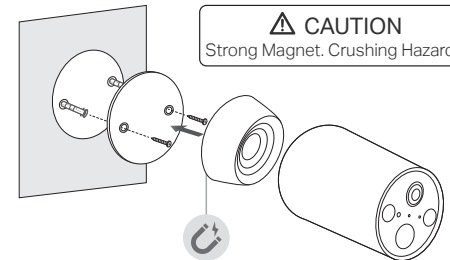

CAUTION
Strong Magnet. Crushing Hazard.

Note:
At 2 meters (6.5 feet) or higher,* we recommend using the Wall Mount Bracket (not included).

*Recommended Installation Height:
2 ~ 3 m (7 ~ 10 ft) above the ground

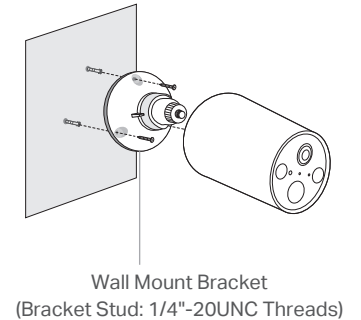

Wall Mount Bracket
(Bracket Stud: 1/4"-20UNC Threads)

Have a Tapo Solar Panel?

The Tapo Solar Panel charges your Smart Wire-Free Security Camera continuously.

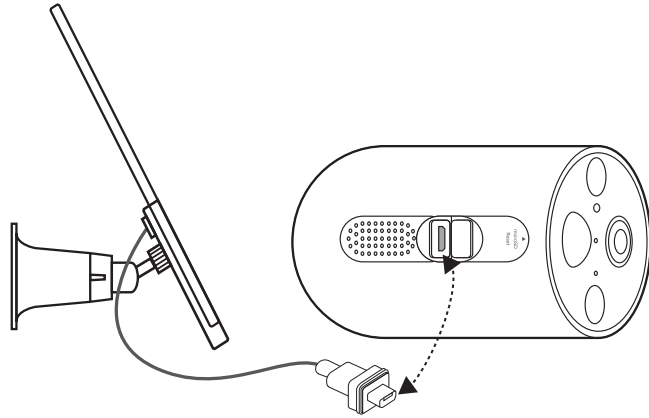

If you don't yet have a Tapo Solar Panel, charge the rechargeable battery with a **standard and high-quality DC 5V/2A battery charger**. Keep the charging port firmly covered when fully charged.

Note: If you use a third-party solar panel to charge this camera, we cannot guarantee the waterproof performance.

Status LED Indication

Blinking amber quickly for 3 seconds	Plugging in USB charger
Solid red	Starting up
Blinking red and green	Ready for setup
Blinking red slowly	Connecting to Wi-Fi
Solid amber	Connected to Wi-Fi
Solid green	Connected to the cloud
Blinking red quickly	Camera resetting
Blinking green quickly	Camera updating

Appearance

Front

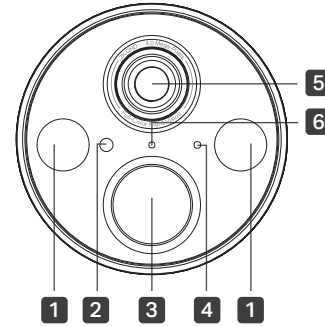

- 1** Spotlights
- 2** Light Sensor
- 3** Motion Sensor
- 4** Microphone
- 5** Lens
- 6** Status LED

Side

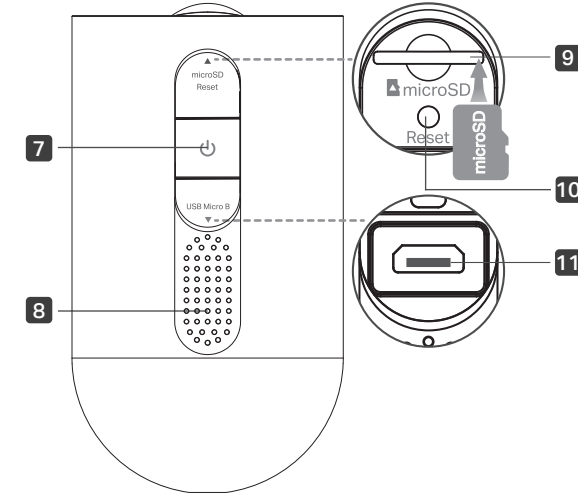

- 7** **Power Button** Press and hold for about 3 seconds to turn on/off the camera.
- 8** **Speaker**
- 9** **microSD Card Slot**
Open the cover. Insert a microSD card* and initialize it on the Tapo app for local recording.
*microSD card not included.
- 10** **Reset Button**
Open the cover. Use a pin to press and hold for at least 5 seconds to reset the camera to factory default settings.
- 11** **USB Micro B Charging Port**
Open the cover for USB charging.

Safety Information

- Do not use damaged charger or USB cable to charge the device.
- Do not use any other chargers than those recommended.
- Do not use the device where wireless devices are not allowed.
- Adapter shall be easily accessible.
- Use only power supplies which are provided by manufacturer and in the original packing of this product. If you have any questions, please don't hesitate to contact us.
- Keep the device away from fire or hot environments. DO NOT immerse in water or any other liquid.
- Do not disassemble, repair or modify the product.
- Do not place near automatically controlled devices such as fire alarms. Radio waves emitted from this product may cause such devices to malfunction resulting in an accident.
- Observe restrictions on using wireless products in fuel depots, chemical plants or when blasting operations are in progress.
- Do not use liquid to clean the product. Only use a dry cloth.
- Never put metal objects inside the product. If a metal object enters the product turn off the circuit breaker and contact an authorised electrician.
- This product is not intended to be used when providing medical care. Consult the manufacturer of any personal medical devices, such as pacemakers or hearing aids to determine if they are adequately shielded from external RF (radio frequency) energy.
- Do not use this product in health care facilities. Hospitals or health care facilities may be using equipment that could be sensitive to external RF energy.
- Do not place heavy objects on top of the product.
- When you leave the product unused for a long time unplug the product from the power outlet.
- This product may interfere with other electronic products such as TV, radios, personal computers, phones or other wireless devices.

- Operating Temperature: -20°C ~ 45°C (-4°F ~ 113°F)
- When mounting the camera with the magnetic base, we recommend installing it no higher than 2 meters.

CAUTION!

Avoid replacement of a battery with an incorrect type that can defeat a safeguard.

Avoid disposal of a battery into fire or a hot oven, or mechanically crushing or cutting of a battery, that can result in an explosion. Do not leave a battery in an extremely high temperature surrounding environment that can result in an explosion or the leakage of flammable liquid or gas; Do not leave a battery subjected to extremely low air pressure that may result in an explosion or the leakage of flammable liquid or gas.

Please read and follow the above safety information when operating the device. We cannot guarantee that no accidents or damage will occur due to improper use of the device. Please use this product with care and operate at your own risk.

TP-Link hereby declares that the device is in compliance with the essential requirements and other relevant provisions of directives 2014/53/EU, 2009/125/EC, 2011/65/EU and (EU)2015/863.

The original EU declaration of conformity may be found at <https://www.tapo.com/support/ce>

TP-Link hereby declares that the device is in compliance with the essential requirements and other relevant provisions of the Radio Equipment Regulations 2017.

The original UK declaration of conformity may be found at <https://www.tapo.com/support/ukca/>



Visit www.tapo.com/support for technical support, user guides, and more information

