

# VC-A51P/ VC-A51PN

## HD Camera

(PTZ Video Camera)

### User Manual - English

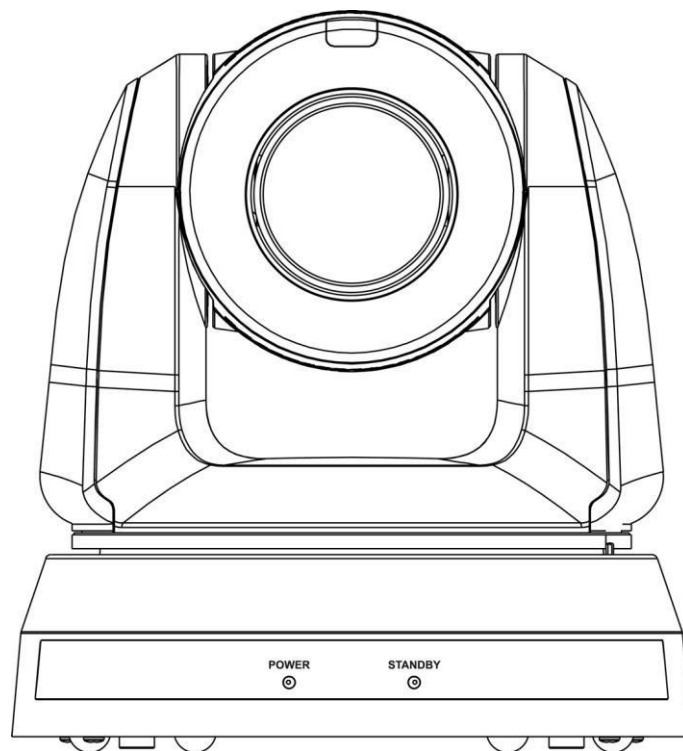

**[Important]**

To download the latest version of Quick Start Guide, multilingual user manual, software, or driver, etc., please visit Lumens <https://www.MyLumens.com/support>

# Table of Contents

<b>Chapter 1</b>	<b>Package Contents .....</b>	<b>2</b>
<b>Chapter 2</b>	<b>Function Introduction .....</b>	<b>3</b>
2.1	I/O functions Introduction.....	3
2.2	Description of LED indicator .....	4
<b>Chapter 3</b>	<b>Instruction for installation .....</b>	<b>5</b>
3.1	Preparation before installation.....	5
3.2	Instruction for installation .....	5
3.3	Connecting devices .....	11
<b>Chapter 4</b>	<b>Remote Control and Setting Menu .....</b>	<b>14</b>
4.1	Functions of remote control.....	14
4.2	Setting Menu.....	15
<b>Chapter 5</b>	<b>Network Function Settings Description .....</b>	<b>19</b>
5.1	Connecting Camera to Network.....	19
5.2	Web Page Function Description .....	22
<b>Chapter 6</b>	<b>DIP Switch Setting .....</b>	<b>36</b>
6.1	OUTPUT Switch.....	36
6.2	IR SELECT .....	36
6.3	Camera Address Selector .....	36
6.4	System Switch.....	36
<b>Chapter 7</b>	<b>Troubleshooting.....</b>	<b>37</b>
<b>Chapter 8</b>	<b>Safety Instructions .....</b>	<b>38</b>
<b>Supplier's Declaration of Conformity 47 CFR § 2.1077 Compliance Information</b>		<b>39</b>
<b>Copyright Information .....</b>		<b>40</b>

# Chapter 1 Package Contents

---

**VC-A51P/ VC-A51PN**

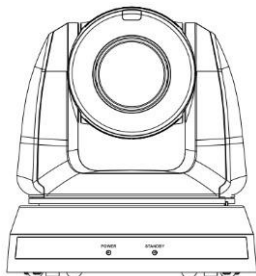

**M3 Screws**

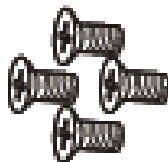

**Silver x 8 / Black x 2**

**Remote Control**



**Power Cord**



**Appearance may vary depending on country/region**

**Power Adapter**

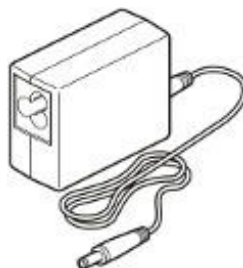

**RS-422 Connector**

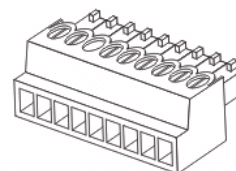

**Metal Plate A**

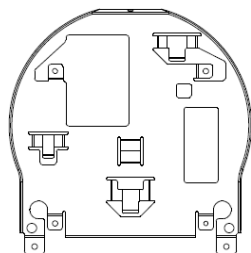

**Metal Plate B**

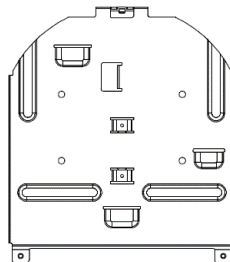

# Chapter 2 Function Introduction

## 2.1 I/O functions Introduction

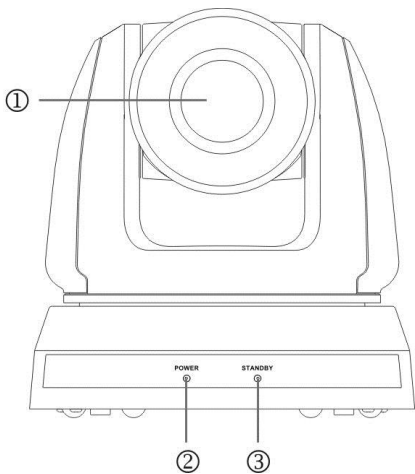

Item	Function Descriptions
1. Camera lens	HD camera lens
2. Power LED	Display the status, please refer to <a href="#">2.2 Description of LED indicator</a>
3. Standby LED	Display the status, please refer to <a href="#">2.2 Description of LED indicator</a>

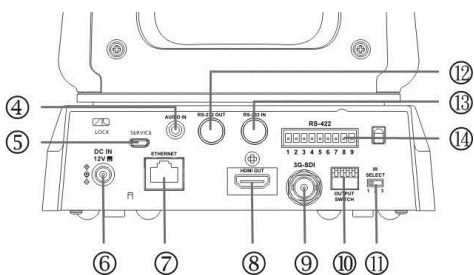

Item	Function Descriptions
4. Audio In	Support Line In/Mic In
5. Micro USB Port	For Firmware Update
6. Power input	AC power supply connecting port
7. Ethernet port	Support IEEE 802.3at PoE + power supply
8. HDMI output	HDMI output (support Audio output)
9. 3G-SDI	3G-SDI output
10.OUTPUT Switch	Adjust the resolution setting. The default is 1920 x 1080/60p
11.IR SELECT	Remote control ID setting It can be controlled only when it corresponds to the Camera Select on the remote control
12.RS-232 output	RS-232 output port, at most 7 cameras can be connected in a serial connection
13.RS-232 input	RS-232 input port, at most 7 cameras can be connected in a serial connection
14.RS-422 connecting	RS-422 connecting port, at most 7 cameras can be connected in a serial connection

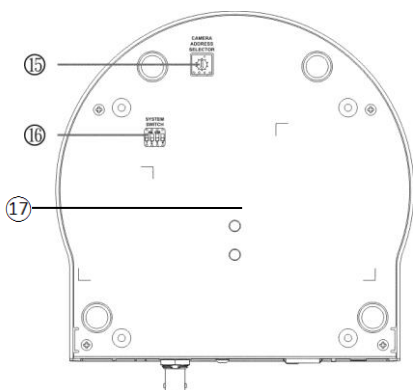

Item	Function Descriptions
15.Camera Address Selectors	Camera ID Setting
16.SYSTEM Switch	System DIP Setting
17.Tripod lock hole	The camera is mounted on a (specification) 1/4" - 20 UNC tripod

## 2.2 Description of LED indicator

Status	Power	Standby
Startup in progress	Green light	Orange light
In use	Green light	No indicator
In standby mode	No indicator	Orange light
Tally mode	Red light	Red light

**<Remark>** The Tally mode can be enabled via RS-232 command control. Please download the file for RS-232 Command Set from the Lumens website

# Chapter 3 Instruction for installation

---

## 3.1 Preparation before installation

Installation and connection of HD camera requires special skills. To install by yourself, please follow necessary steps, ensure steady and tight installation of the device, and pay attention to your safety to avoid any accident.

- Ensure the safety of the installation environment. Please do not install the device on unstable ceiling or in a place where the device is in danger of falling to avoid any accident
- Please check whether accessories in the box are complete or not. Please contact the supplier for any shortage, and make sure to keep the accessories in the box intact.
- Please choose a proper place for installation of camera in advance. Please determine an installation place according to the following requirements
  1. Confirm the position for the object to be captured.
  2. Confirm whether the camera is set at a proper distance from other light sources.

## 3.2 Instruction for installation

### 3.2.1 I would like to install camera on the desk

#### 3.2.1.1 Precautions for installation

- Please install the machine on a flat desk
- Do not grab the camera head by hand when handling the device
- Do not rotate the camera head by hand. Improper rotation may result in breakdown of the camera

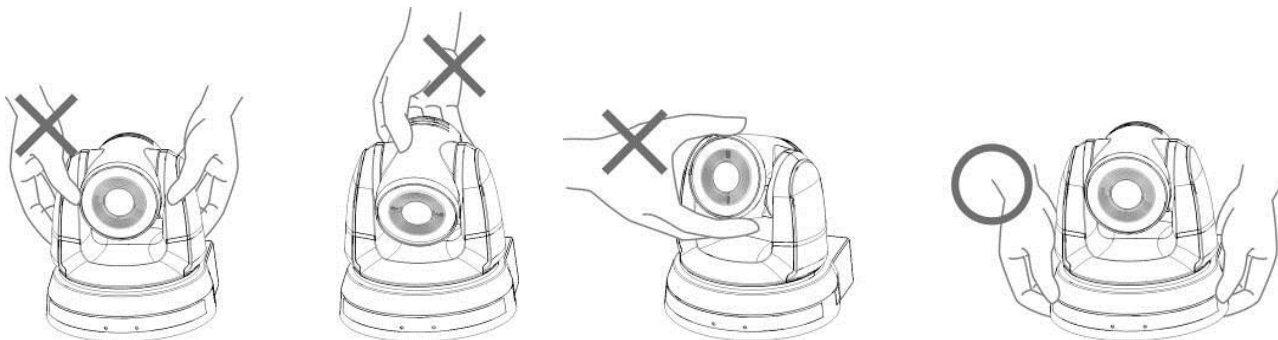

#### 3.2.1.2 Installation steps

1. Please adjust DIP switch at first prior to installation
  - Please refer to [Chapter 6 DIP Switch Setting](#) for the relevant descriptions on DIP switch.
2. Place the camera on a flat desk directly to ensure the normal vertical and horizontal operation of the machine

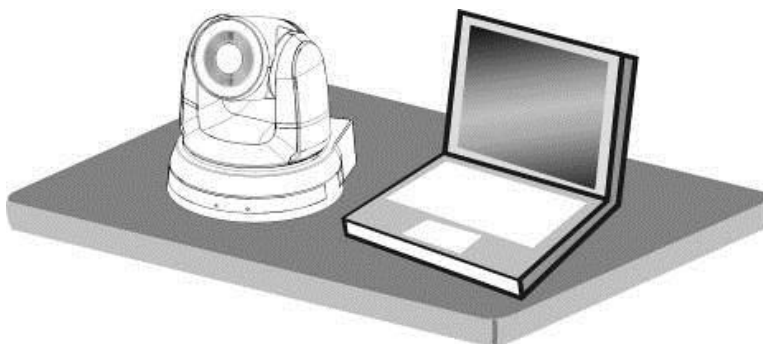

### 3.2.2 I would like to install the camera on the ceiling

#### 3.2.2.1 Prepare for the parts and equipment required during the installation

- Accessories in the box (metal plates A, B, M3 screw silver x 8, black x 2)
- Screw for locking on ceiling mounted hanger x 4
- Drilling machine, screw driver, ladder

#### 3.2.2.2 Camera Size

- L x W x H: 174 x 187 x 186 mm
- Weight: 2.0 Kg

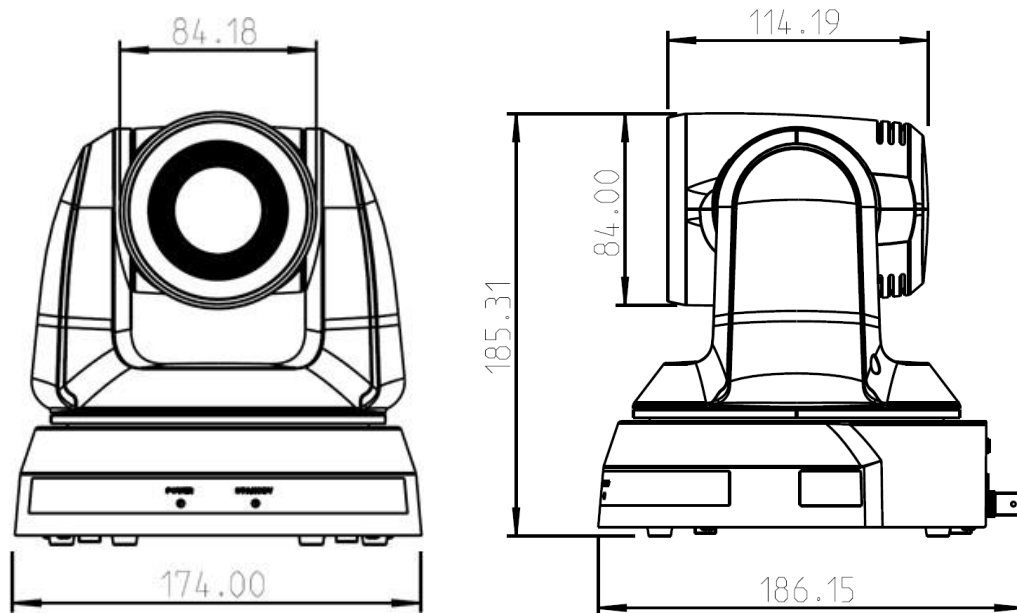

#### 3.2.2.3 Dimensions of the bottom of the machine

The camera can be mounted on a 1/4", -20 UNC PTZ tripod deck by using the lock holes on the bottom for the tripod

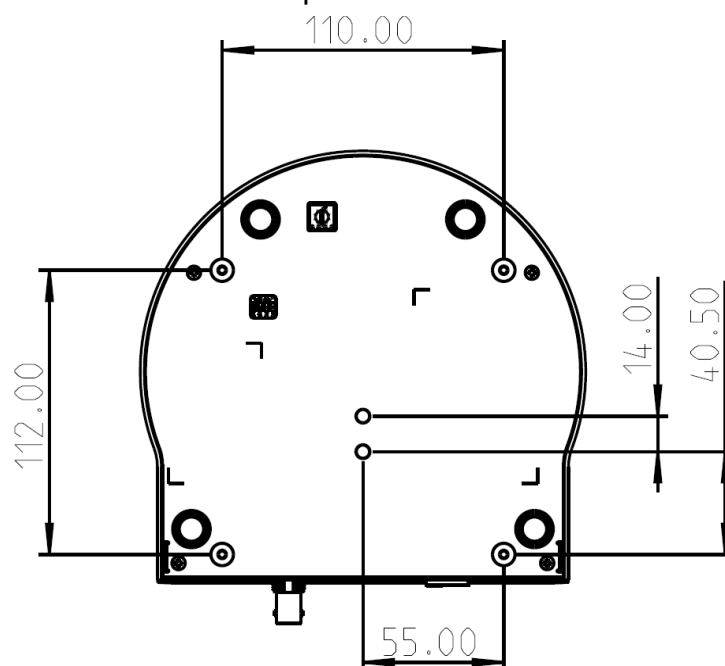

### 3.2.2.4 Metal Plate size diagram

#### ■ Metal plate A - machine side

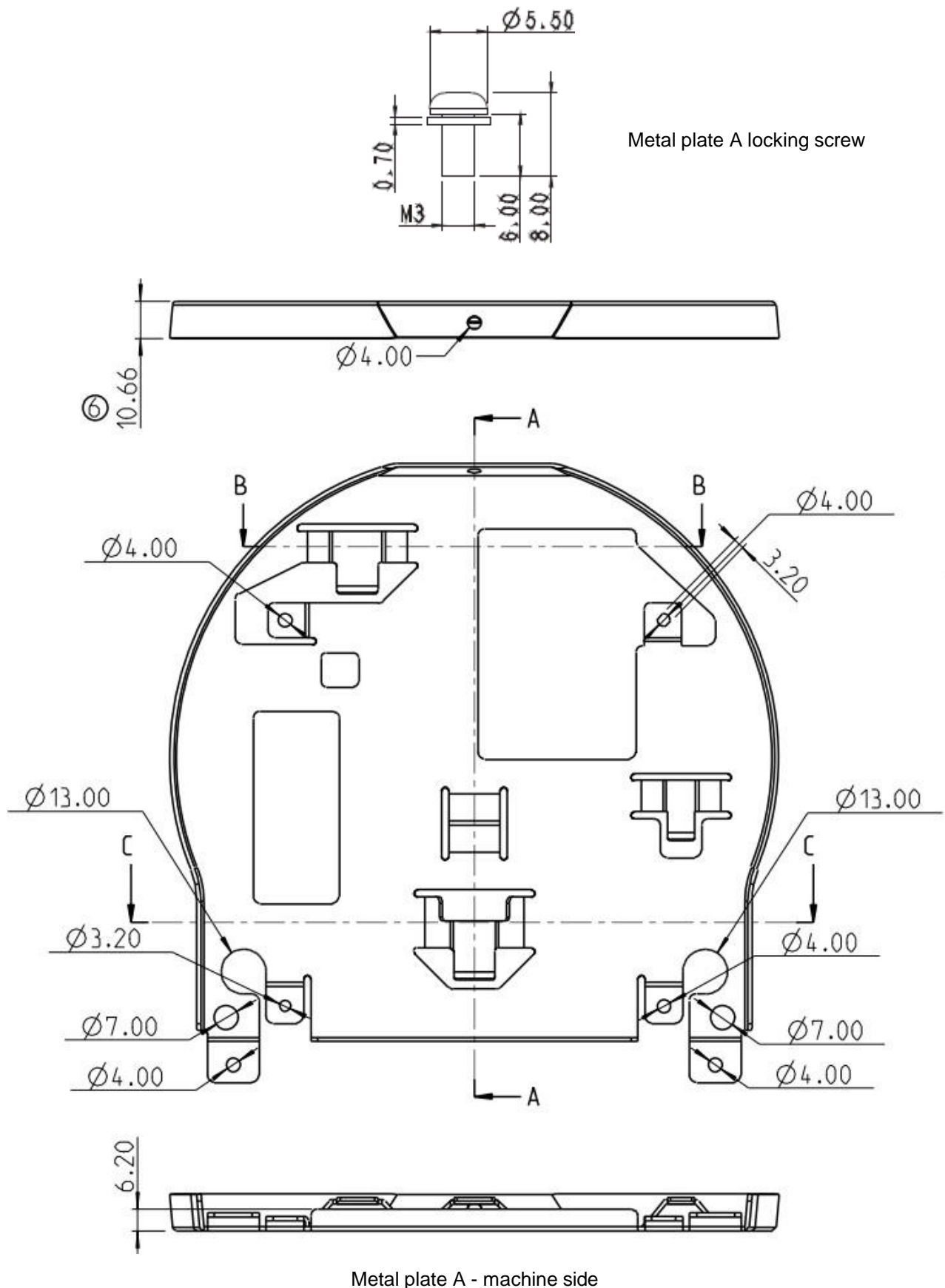



■ Metal plate B - ceiling side

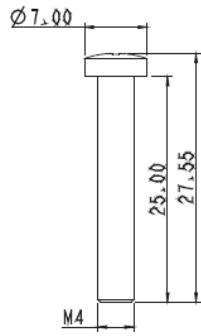

Metal plate B locking screw

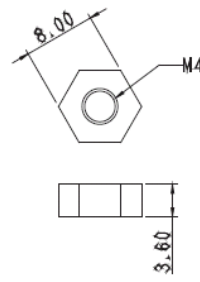

Metal plate B locking bolt

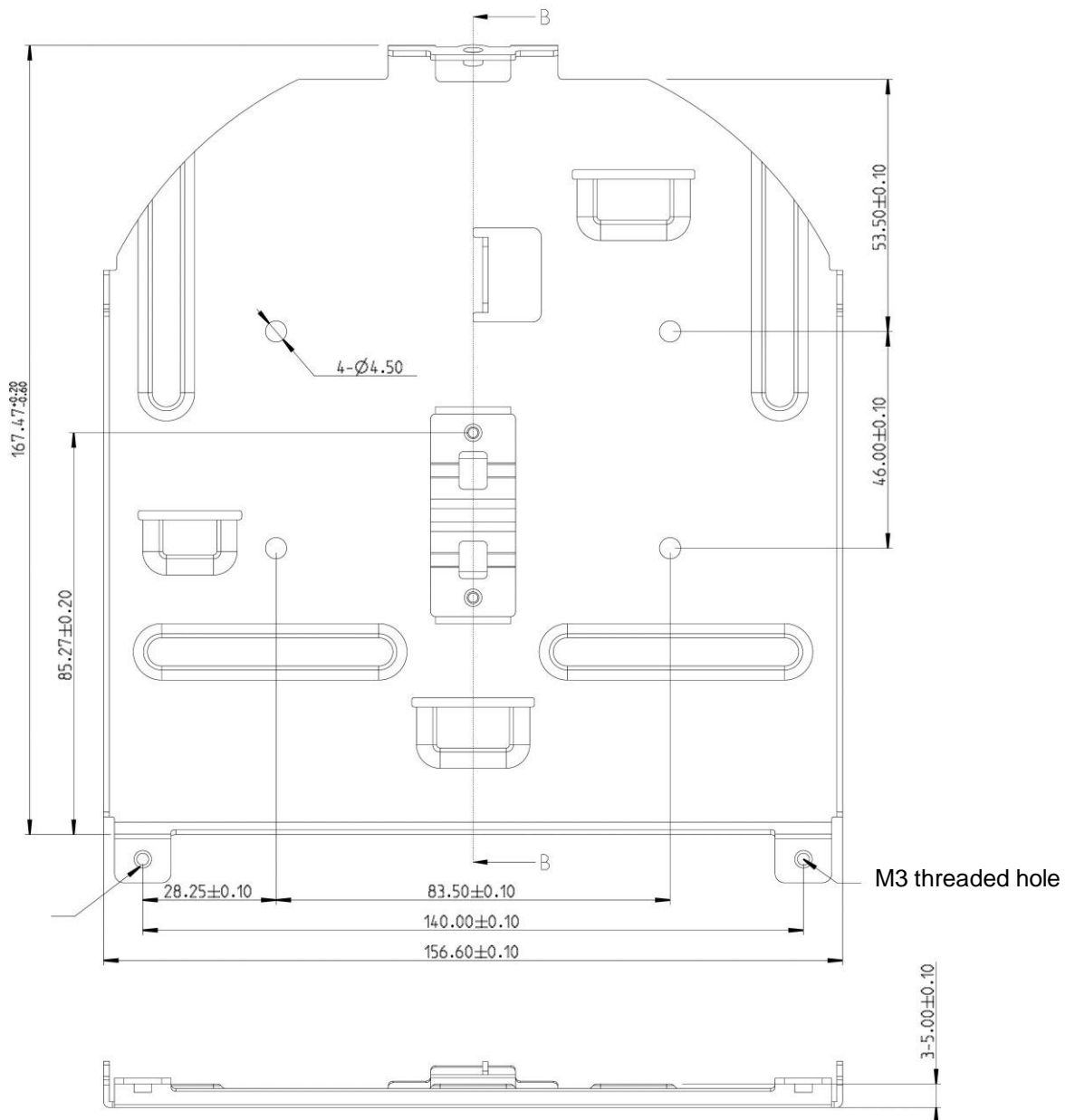
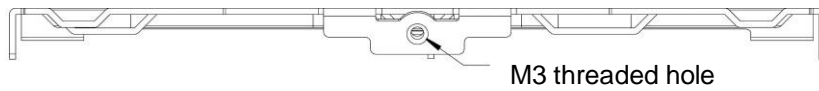

Metal plate B - ceiling side

### 3.2.2.5 Precautions for installation

- Before installation, please confirm the orientation of the machine relative to the object to be captured
- It is recommended that the machine should be set at a distance of more than 1.5 meter away from the object to be captured. Please adjust for a best distance according to the magnification of the lens

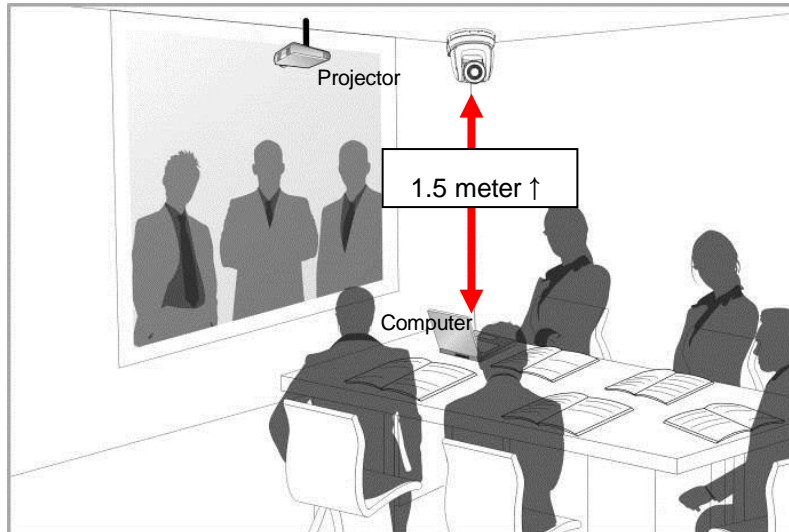

- The machine (including metal plates) is weighed at about 2.5 kg. If it is to be installed on the ceiling, please use the hanger that has obtained UL security approval to prevent the machine from falling down.
- Please check whether the camera is installed securely on a regular basis

### 3.2.2.6 Installation steps

1. Please adjust resolution on DIP switch at first
  - ※ Please refer to [Chapter 6 DIP Switch Setting](#) for the relevant descriptions on DIP switch
2. Fix the metal plate A on the machine base with 4 M3 silver screws

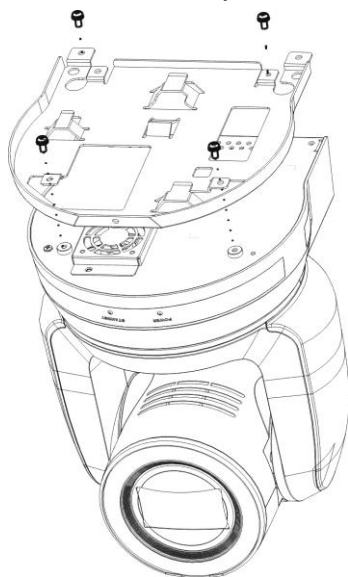

3. Lock the metal plate B on ceiling mounted hanger

- <Note> (1) Please use the hanger that has obtained UL security approval  
(2) Please reserve the hole for the connecting wires of the camera

4. Combine the metal plate A and the metal plate B

(1) Push the metal plate A up to the ceiling and then to the right to latch the metal plate B

(2) And then secure with 2 M3 silver screws and 1 M3 black screw

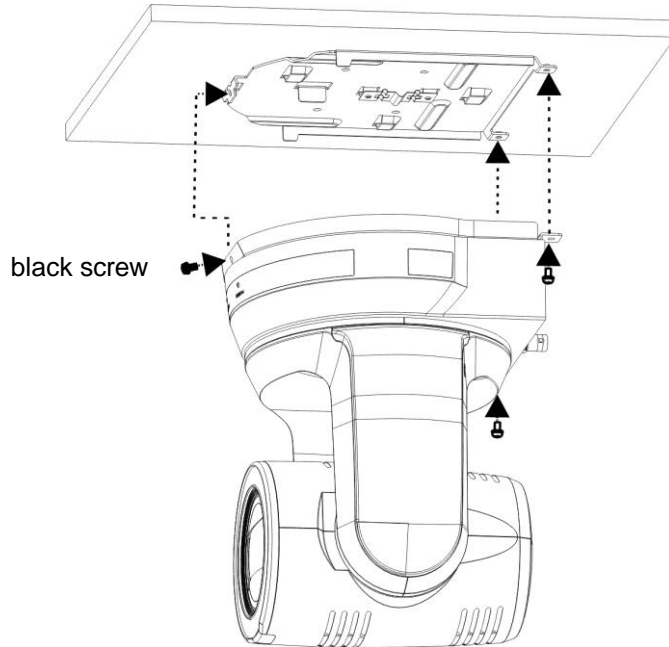

3.2.2.7 **How to remove**

1. Remove the connecting wires from the camera

2. Uninstall the camera together with the ceiling, loosen the three screws that fix the metal plates A and B and push to the left to remove the machine

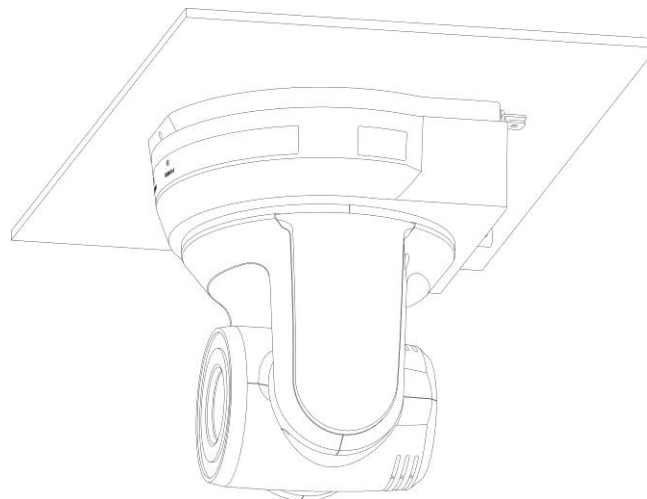

3. Then remove the screws on the hanger and the machine

### 3.3 Connecting devices

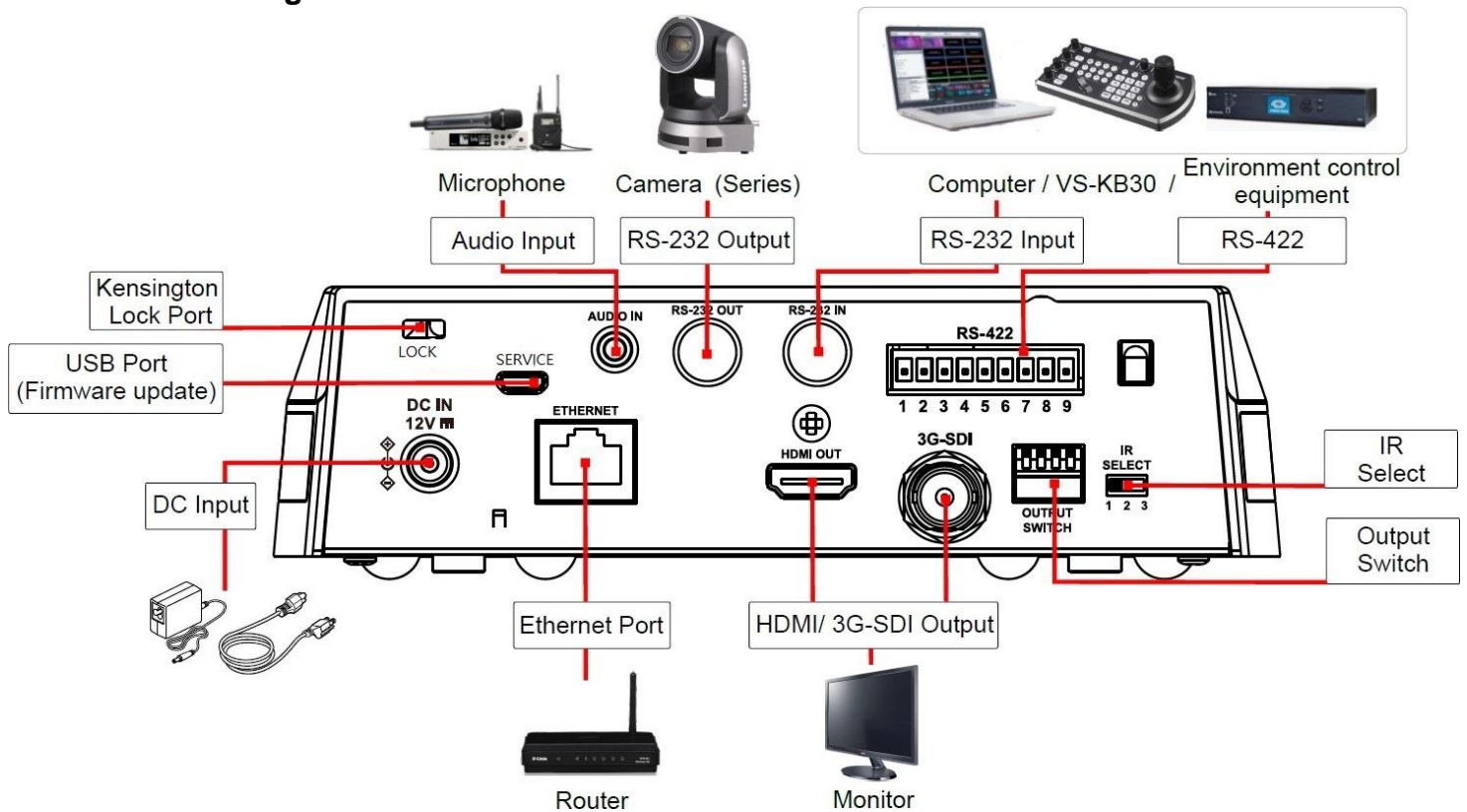

#### 3.3.1 RS-232 connection (at most 7 Lumens cameras can be connected)

※ Only one of RS-422/RS-232 can be selected for control, please refer to [6.4 System Switch](#), DIP1 setting

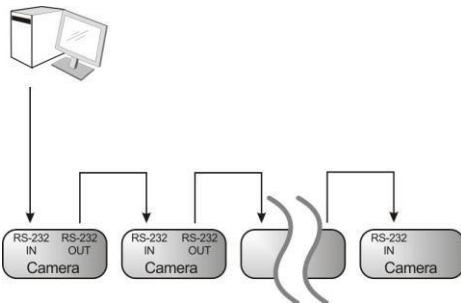

#### ■ RS-232 pins definition instructions

##### ▼ RS-232 IN Pins Instructions

NO	Pins	Signals
1	DTR	Data Transmission Reade
2	DSR	Data Set Reade
3	TXD	Transmit Data
4	GND	Ground
5	RXD	Receive Data
6	GND	Ground
7	IR OUT	IR Commander Signal
8	N.C.	No Connection

##### ▼ RS-232 OUT Pins Instructions

NO	Pins	Signals
1	DTR	Data Transmission Reade
2	DSR	Data Set Reade
3	TXD	Transmit Data
4	GND	Ground
5	RXD	Receive Data
6	GND	Ground
7	OPEN	Reserved
8	OPEN	Reserved

##### ▼ RS-232 Connection Instructions

RS-232 IN of VC	RS-232 of PC
1. DTR	1. CD
2. DSR	2. RXD
3. TXD	3. TXD
4. GND	4. DTR
5. RXD	5. GND
6. GND	6. DSR
7. IR OUT	7. RTS
8. N.C.	8. CTS
	9. RI

##### ▼ RS-232 Connection Instructions

RS-232 IN of Next Camera	RS-232 OUT of Last Camera
1. DTR	1. DTR
2. DSR	2. DSR
3. TXD	3. TXD
4. GND	4. GND
5. RXD	5. RXD
6. GND	6. GND
7. IR OUT	7. OPEN
8. N.C.	8. OPEN

### 3.3.2 RS-422 connection (at most 7 Lumens cameras can be connected)

※ Only one of RS-422/RS-232 can be selected for control, please refer to [6.4 System Switch](#), DIP1 setting

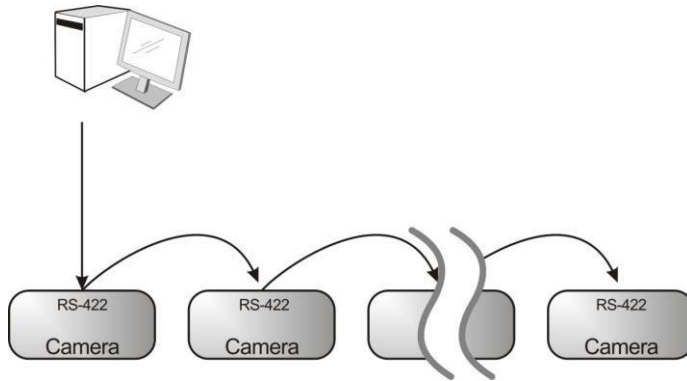

#### ■ RS-422 pins definition instructions

##### ▼ RS-422 Pins Instructions

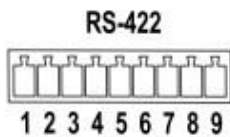

Pin NO.	Function
1	RXD OUT-
2	RXD OUT+
3	TXD OUT-
4	TXD OUT+
5	GND
6	RXD IN-
7	RXD IN+
8	TXD IN-
9	TXD IN+

##### ▼ RS-422 Serial Connection

Up to seven cameras can be daisy-chained

⋮  
⋮  
⋮

Third Camera

1	RXD OUT-
2	RXD OUT+
3	TXD OUT-
4	TXD OUT+
5	GND
6	RXD IN-
7	RXD IN+
8	TXD IN-
9	TXD IN+

Second Camera

1	RXD OUT-
2	RXD OUT+
3	TXD OUT-
4	TXD OUT+
5	GND
6	RXD IN-
7	RXD IN+
8	TXD IN-
9	TXD IN+

First Camera

Compact Camera Controller

1	NC
2	NC
3	NC
4	NC
5	GND
6	RXD IN-
7	RXD IN+
8	TXD IN-
9	TXD IN+

1	RXD OUT-
2	RXD OUT+
3	TXD OUT-
4	TXD OUT+
5	GND
6	RXD IN-
7	RXD IN+
8	TXD IN-
9	TXD IN+

##### ▼ RS-422 Connection Instructions

— Applicable to

**Lumens Compact Camera Controller**

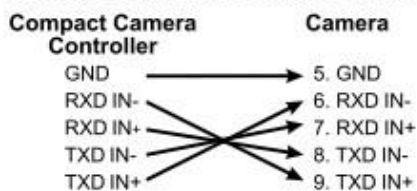

##### ▼ RS-422 Connection Instructions

— Applicable to

**SONY Compact Camera Controller**

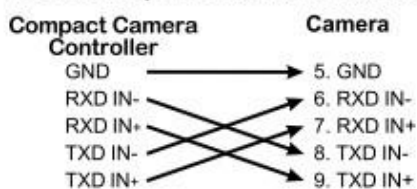

■ RS-422 connection instructions

1. Hold the two sides of RS-422 connector and pull out in the direction shown by the arrow in the figure below

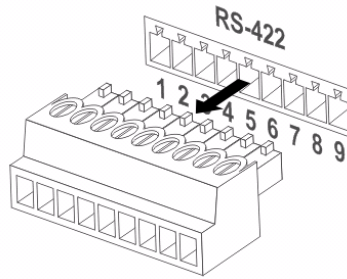

2. Peel off a section of copper wire (AWG Nos. 28 to 18) and insert it into the connector hole; then use flat screw driver to fix it

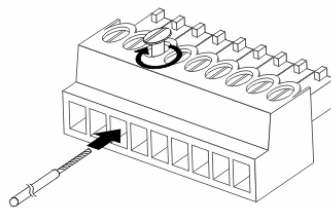

3. Insert the wired RS-422 connector back to the camera. Now the connection is completed

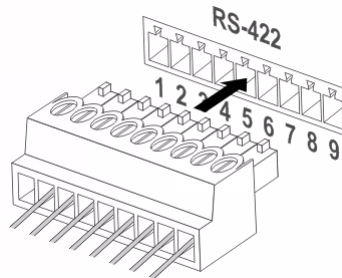

# Chapter 4 Remote Control and Setting Menu

## 4.1 Functions of remote control

- The below functions are listed alphabetically

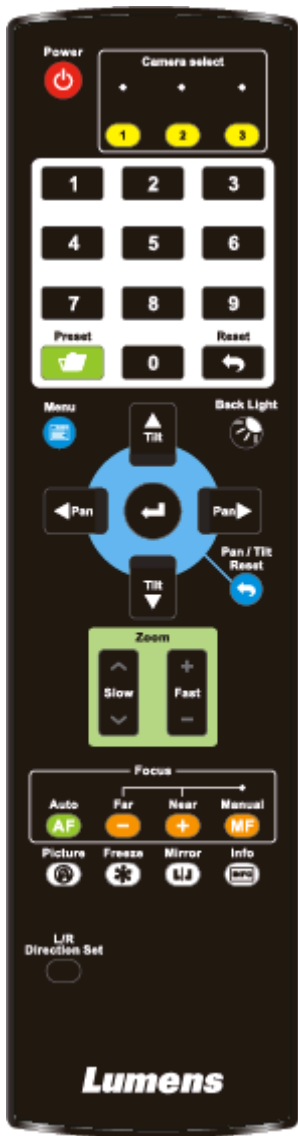

Item	Remark
◀, ▶, ▲, ▼	Move the lens
Back Light	Turn on/off back light compensation
Camera select	Choose camera ID 1 ~ 3
Focus-Manual / Far/Near	Turn on manual focus to adjust the focal length
Focus-Auto	Auto Focus
Freeze	Freeze the screen
Home-Enter	Go back to the main page / Execute
Info	Status information
L/R Direction Set	L/R Direction / Normal
Menu	Display OSD menu
Mirror	Rotate the image (OFF / Mirror / Flip / Rotate)
Pan/Tilt Reset	Clear the Pan / Tilt setting
Picture	Switch image effect (OFF / Neg / B&W)
Power	Power Switch
Preset	Appoint an ID (0 ~ 9) to save the current position data
Reset	Appoint an ID (0 ~ 9) to delete the current position data
Zoom-Fast	Adjust image size
Zoom-Slow	Fine-tune image size

## 4.2 Setting Menu

※ Press [**MENU**] on the **remote control** to enter the setting menu; the **bold underlined** values in the following table are defaults.

1st Level Major Items	2nd Level Minor Items	3rd Level Adjustment Values		Function Descriptions
Exposure	Mode	<u>Automatic</u> /Shutter Priority/Aperture Priority/Manual		Exposure mode setting
	Exposure Comp.	On / <u>Off</u>		AE Level
	Exposure Comp. Level	-6~ <u>C</u> ~5		The value can be adjusted after <b>Exposure Comp.</b> is activated
	Shutter Pri	60/30 mode	50/25 mode	Adjustable when the <b>Exposure mode</b> is set to <b>Shutter Pri</b>
		1/10000~1/1		
	Iris Pri	<u>F1.6</u> ~F6.3		Adjustable when the <b>Exposure mode</b> is set to <b>Iris Pri</b>
	Manual Gain	<u>0</u> ~45dB		Adjustable when the <b>Exposure mode</b> is set to <b>Manual</b>
	Manual Speed	60/30 mode	50/25 mode	Manually set the shutter
		1/10000~1/1		
	Manual Iris	<u>F1.6</u> ~F6.3		Manually set the iris
	Gain Limit	9~ <u>C</u> ~45dB		Max. limit value of electron gain
Iris Limit	F1.6~ <u>C</u> ~F6.3		Max. limit value of iris	
WDR	<u>Off</u> / 1/ 2/ 3/ 4/ 5			
White Balance	Mode	1. <u>Auto</u> 2. Indoor 3. Outdoor 4. One Push WB 5. ATW 6. Manual 7. Sodium Lamp 8. 3000K 9. 4300K 10. 5000K 11. 6500K 12. 8000K 13. WideAuto		Select the color temperature mode 1. 4000k ~ 7000k 2. 3200k 3. 5800k 4. 1700k ~ 10000k 5. 1700k ~ 10000k 6. Custom 7. 2800k
	One Push Trigger	<u>ENTER</u>		One push trigger
	Manual Red	0~ <u>C</u> ~128		Adjustable when the white balance mode is set to <b>Manual</b>



1st Level Major Items	2nd Level Minor Items	3rd Level Adjustment Values	Function Descriptions
	Manual Blue	0~ <u>C</u> -128	Adjustable when the white balance mode is set to <b>Manual</b>
Picture	Picture effect	<b>OFF</b> / Neg / B&W	
	Sharpness	0~ <u>C</u> -15	
	2D NR	<b>AUTO</b> / OFF / <u>1</u> / 2/ 3/ 4/ 5	
	3D NR	Off / Low / <b>Standard</b> / Highest / Auto	
	Image Mode	Mode 1 ~ 6/Self-defined	The user may customize his/her desired image mode
	Image Mode Load	<b>ENTER</b>	Adjustable when the <b>Image mode</b> is set to <b>Custom</b> . After selected, the corresponding <b>Image mode</b> parameters will be read and applied to <b>Custom</b>
	Brightness	0~ <u>C</u> -25	Adjustable when the <b>Image mode</b> is set to <b>Custom</b>
	Contrast	0~ <u>C</u> -25	Adjustable when the <b>Image mode</b> is set to <b>Custom</b>
	Saturation	0~ <u>C</u> -25	Adjustable when the <b>Image mode</b> is set to <b>Custom</b>
	Black Level	Type 1 ~ 5 / <b>Off</b>	Adjustable when the <b>Image mode</b> is set to <b>Custom</b>
	Gamma	0~ <u>C</u> -3	Adjustable when the <b>Image mode</b> is set to <b>Custom</b>
	Skin Tone	0~ <u>C</u> -5	
Pan Tilt Zoom	Pan/Tilt Limit	On / <b>Off</b>	On / Off Turn on/off the angle limit setting
	Pan Right Limit	0~ <b>170</b>	Limit the right angle
	Pan Left Limit	<b>-170</b> ~0	Limit the left angle
	Tilt UP Limit	0~ <b>90</b>	Limit the upward angle
	Tilt Down Limit	<b>-30</b> ~0	Limit the downward angle
	Pan Flip	On / <b>Off</b>	Activate the reverse Pan command
	Tilt Flip	On / <b>Off</b>	Activate the reverse Tilt command
	Preset Speed	5 ~ 300 deg/sec	Set the rotation speed of the cradle head when Preset is executed
	PTZ Speed Comp	On / <b>Off</b>	Set the Pan/Tilt moving speed to vary from the zoom position
	Zoom Limit	<b>x1</b> ~x20	Set the zoom ratio limit
D-Effect	Mirror	<b>OFF</b> / Mirror / Flip / Mirror + Flip	Set the mode at which the image is turned

1st Level Major Items	2nd Level Minor Items	3rd Level Adjustment Values	Function Descriptions
Auto Focus	AF Sensitivity	Low / <u>Mid</u> / High	For AF triggering speed, the higher the speed is, the faster AF is triggered
	AF Frame	Center Area / <u>All Area</u>	AF frame setting, when central area was set as AF frame, focusing will be on the center of the screen. When Full Frame was set as AF frame, focusing will be calculated based on the full screen
	PTZ Assist	On / <u>Off</u>	Turn on the auto focus function in Manual
Ethernet	DHCP	<u>On</u> / Off	Enable/Disable DHCP setting using left and right arrow keys and press [ENTER] to apply setting.
	IP Address	<u>192.168.100.150</u>	Press [ENTER] to be in modify mode; select the item to be modified using the up and down keys, and modify the value using the left and right keys or the numeric keys.
	Subnet mask	<u>255.255.255.0</u>	
	Gateway	<u>192.168.100.254</u>	
Audio	Audio In	<u>Line In</u> / Mic In	Set Audio In
	Audio Enable	On / <u>Off</u>	Turn on/off audio output
	Audio Volume	0~ <u>C</u> ~10	Volume Setting
	Audio Delay	On / <u>Off</u>	When audio and video are out of sync, enable this feature to set the audio delay time
	Audio Delay Time(ms)	<u>-1</u> --500ms	Set audio delay time
	Encode Sample Rate	<ol style="list-style-type: none"> <li>1. <u>48 KHz(AAC)</u></li> <li>2. 44.1 KHz(AAC)</li> <li>3. 16 KHz(AAC)</li> <li>4. 16 KHz(G.711)</li> <li>5. 8 KHz(G.711)</li> </ol>	Set the encode type and sample rate <b>&lt;Remark&gt; SDI only supports 48 KHz audio output</b> <b>&lt;Remark&gt; VC-A51PN only supports 48 KHz (AAC)/44.1 KHz (AAC) settings</b>
System	Prompt	On / <u>Off</u>	Turn on/off the prompt information on the display
	IR Receive	<u>On</u> / Off	
	Tally Lamp	<u>On</u> / Off	Select Off and it will not be triggered by commands to turn on or off
	Language	<u>English</u> / Chinese	

1st Level Major Items	2nd Level Minor Items	3rd Level Adjustment Values	Function Descriptions
	<b>Initial Position</b>	<u>Last MEM</u> / 1st Preset	Select the camera lens to return to the last operated position or the first preset position after POWER ON ※First default position = Preset 0
	<b>Control Device</b>	Encoder / <u>Controller</u>	Control Device setting, Controller: for joystick Encoder: for tracking system
	<b>Motionless Preset</b>	On / <u>Off</u>	When the function is enabled, the screen will Freeze when Preset is executed. Freeze will be released after Preset is completed.
	<b>Protocol</b>	<u>VISCA</u> / Pelco D	
	<b>Pelco D Address</b>	<u>1</u> ~255	The Protocol set to Pelco D allows the camera ID address to be assigned
	<b>Output Mode</b>	1080p 60/59.94/50/30/29.97/25 1080i 60/59.94/50 720p 60/59.94/50	Choose the output resolution
	<b>Factory Reset</b>	On / <u>Off</u>	Resume the factory default setting
	<b>FW Upgrade</b>	On / <u>Off</u>	
<b>Status</b>			Display the current setting status

# Chapter 5 Network Function Settings Description

## 5.1 Connecting Camera to Network

### 5.1.1 Connecting to Internet

Two common connection methods are shown below

#### 1. Connecting via switch or router

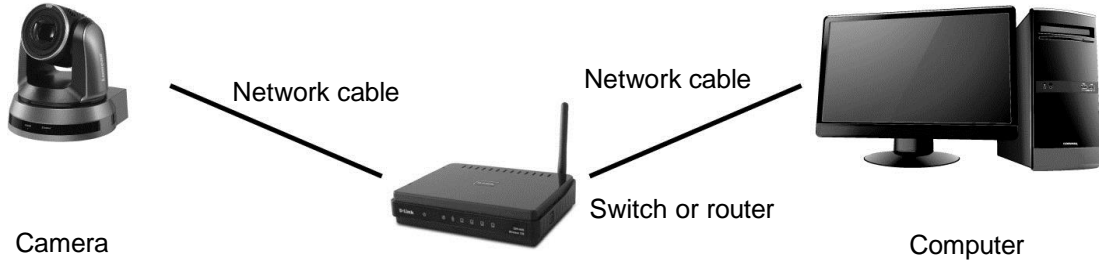

#### 2. To connect directly through network cable, the IP address of the computer should be changed so that it is on the same network segment as the camera

E.g.: The factory-preset default IP address of the camera is 192.168.100.150. The computer IP address must be set with the same network segment, such as 192.168.100.101, so that the computer can be connected correctly with the camera

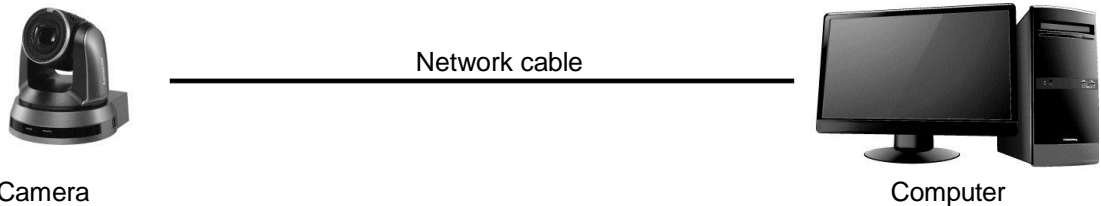

#### • Change network settings

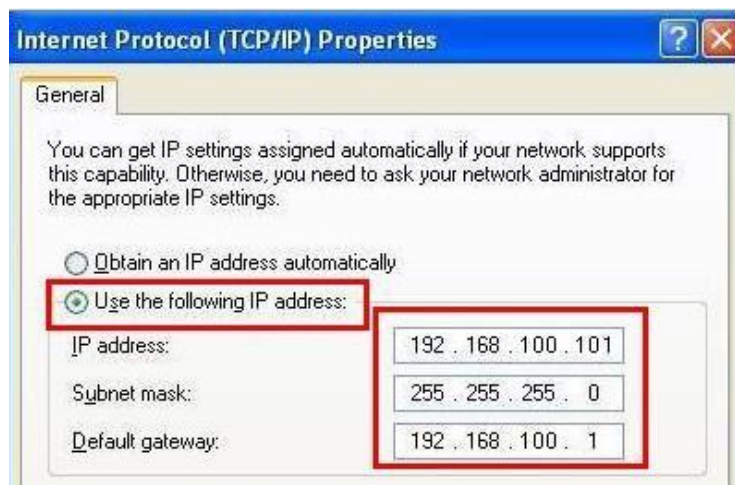

### 5.1.2 Using the Browser to View the Images

- Open the browser, and enter the URL of camera in the IP address bar  
E.g.: <http://192.168.100.150> (default IP address)
- Enter administrator's account and password  
\*When log in for the first time, please refer to [5.2.3 Account Management](#) to change the default password.

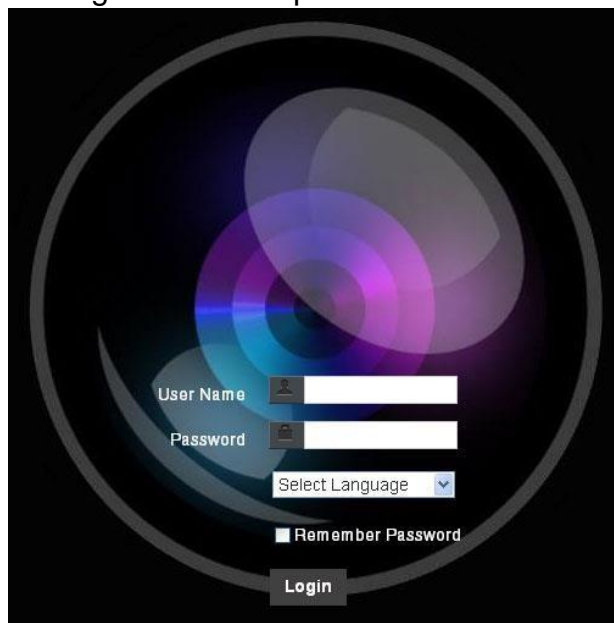

Lumens Network Camera	
●	Account: admin
●	Password: 9999 (Default)

### 5.1.3 Using Lumens VMS Software to View the Images

<Remark> For VC-A51PN, turn off NDI|HX to support preview screen (Please refer to [5.2.4 Setting - Video -NDI|HX](#))

- Open **LUMENS VMS** software (Please download from the Lumens official website)
- Search Camera: Press  [automatically search for the device] button to locate the Camera
- Click the camera in the list and start operation after connecting to network
- ※ **When using automatic search, the camera and computer must be in the same network segment, e.g.: 192.168.4.X**

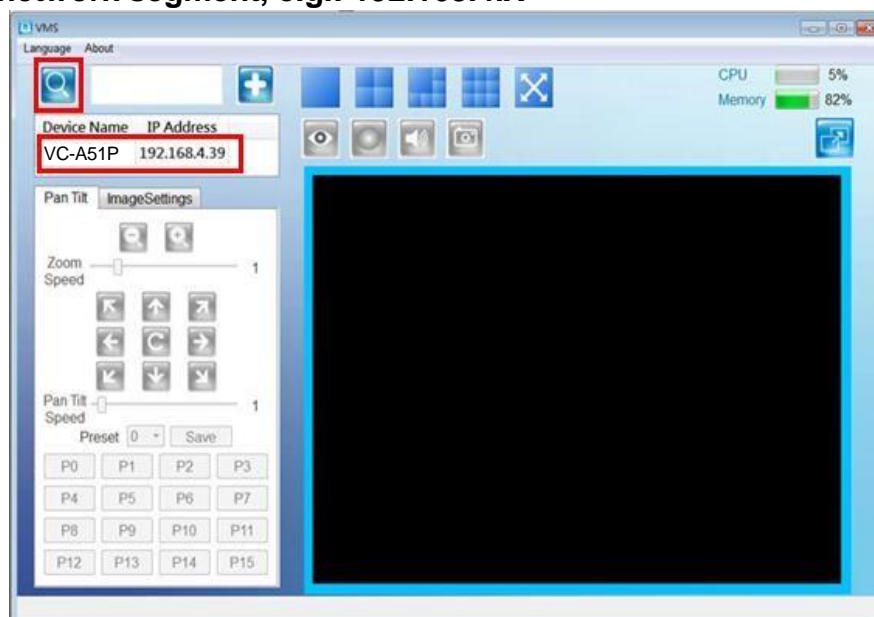

#### 5.1.4 Using RTSP Player to View the Images

<Remark> For VC-A51PN, turn off NDI|HX to support preview screen (Please refer to [5.2.4 Setting - Video -NDI|HX](#))

In addition to the browser and VMS, other free softwares also can be used for RTSP connection, such as VLC, Quick Time and PotPlayer

RTSP connection address formats are as follows:

- RTSP main stream (h264)=><rtsp://VC IP Address:8557/h264>
- RTSP second stream (h264) =><rtsp://VC IP Address:8556/h264>
- RTSP second stream (MJPEG) or single stream in MJPEG=><rtsp://VC IP Address:8555/mjpeg>

If password authentication is enabled, the RTSP connection address is as follows:

- <rtsp://Username:Password@VC IP address:port/hevc>
- <rtsp://Username:Password@VC IP address:port/mjpeg>

<Remark> To enable password authentication function, please refer to [5.2.9 Setting - Network](#)

Example:

Open VLC software, click [Open Network Streaming], and enter a URL:

<rtsp://192.168.100.150:8557/h264>

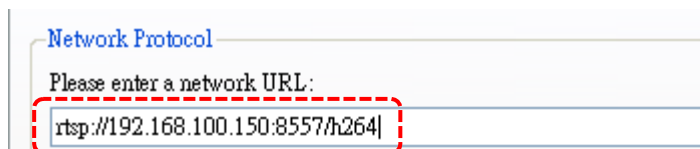
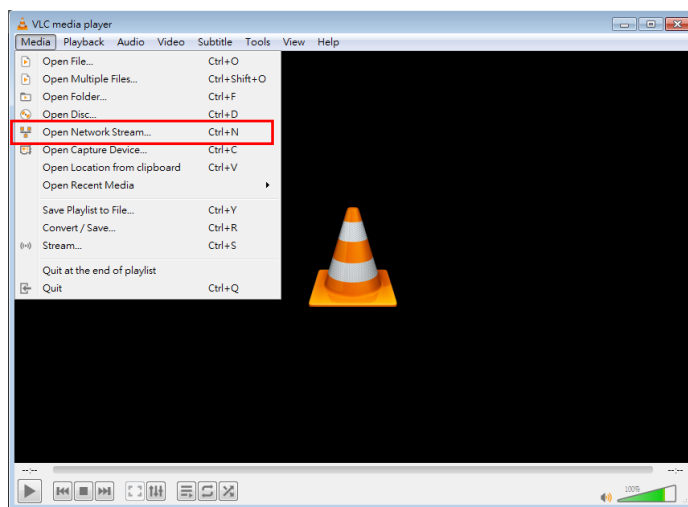

#### 5.1.5 Using NDI Studio Monitor to View the Images

<Remark> Applicable to VC-A51PN. Support when NDI|HX is on (Please refer to [5.2.4 Setting - Video -NDI|HX](#))

- For the NDI|HX operation, please download the latest NDI software from the NewTek website <https://www.newtek.com/>

## 5.2 Web Page Function Description

### 5.2.1 Login Screen



No	Item	Function Descriptions
1	Username	Enter user account (default: admin)
2	Password	Enter user password (default: 9999) ※ When log in for the first time, please refer to <a href="#">5.2.3 Account Management</a> to change the default password.
3	Language selection	Currently, the system supports English, Traditional Chinese and Simplified Chinese
4	Remember password	Save user account name and password to the browser. When you log in next time, there is no need to re-enter them
5	Login	Log into the administrator screen on the website

## 5.2.2 Viewing In Real Time

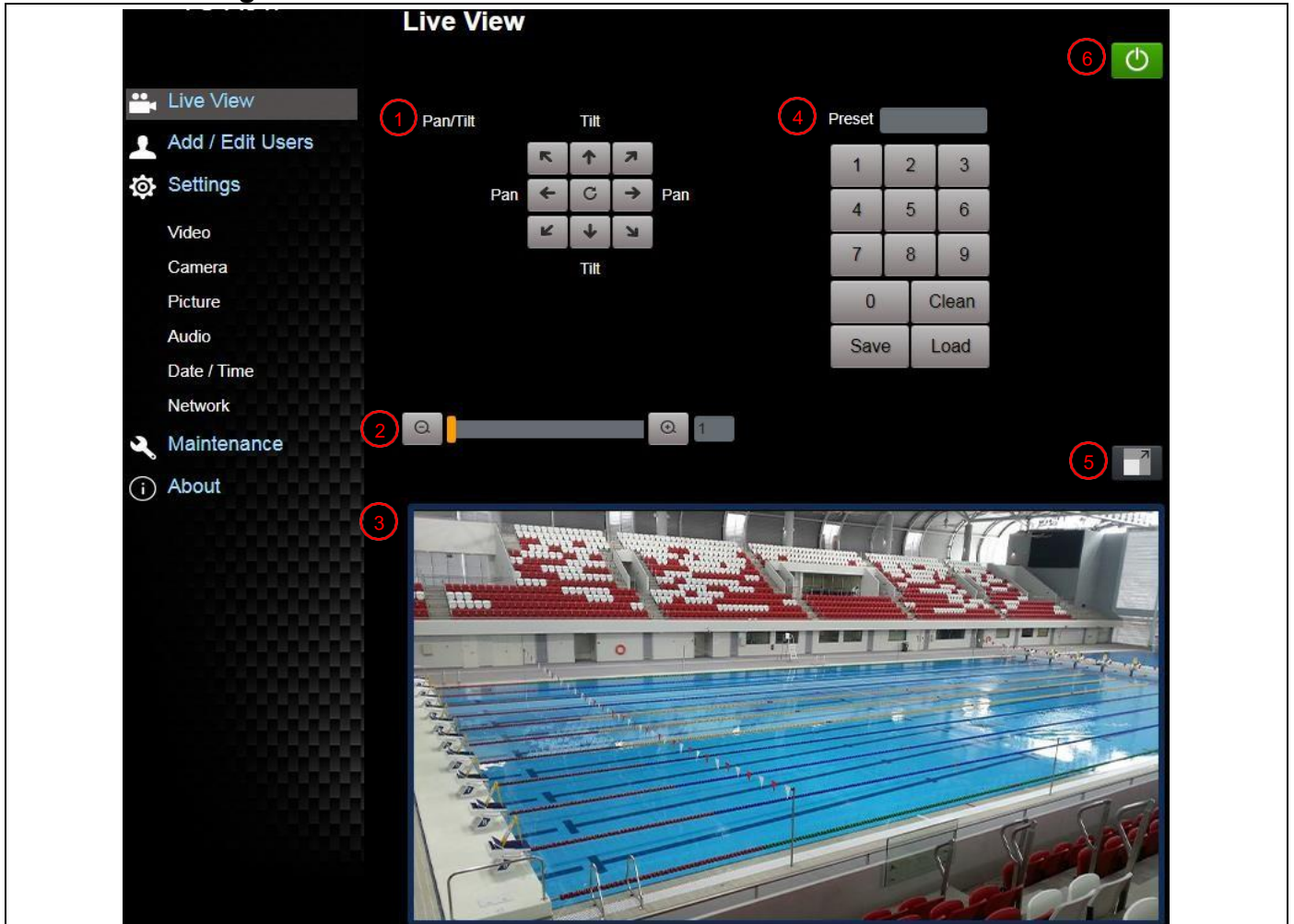

No	Item	Function Descriptions	VC-A51P	VC-A51PN
1	Pan / Tilt setting	Adjust the Pan/Tilt position of the camera screen	v	v
2	Zoom ratio	Adjust the zoom-in or zoom-out ratio via scroll bar	v	v
3	Preview window	Display the screen currently captured by the camera	v	<b>*Note 1</b>
4	Preset setting	Select the number first and then select SAVE or LOAD	v	v
5	Switch to Full Screen	Switch the preview window to full screen	v	<b>*Note 1</b>
6	Power button	Turn on or turn off the camera power	v	v

\*Note 1: Support when NDI|HX is Off



## 5.2.3 Account Management

No	Item	Function Descriptions																
1	Add user account	Enter a user name and password to add a new user																
2	Permission setting	Set the new account management permissions <table border="1"> <thead> <tr> <th>User Type</th> <th>Admin</th> <th>Operator</th> <th>Viewer</th> </tr> </thead> <tbody> <tr> <td>View images</td> <td>V</td> <td>V</td> <td>V</td> </tr> <tr> <td>Settings</td> <td>V</td> <td>V</td> <td>X</td> </tr> <tr> <td>Account management</td> <td>V</td> <td>X</td> <td>X</td> </tr> </tbody> </table>	User Type	Admin	Operator	Viewer	View images	V	V	V	Settings	V	V	X	Account management	V	X	X
User Type	Admin	Operator	Viewer															
View images	V	V	V															
Settings	V	V	X															
Account management	V	X	X															
3	Applying setting	Add the newly created user to the list of account																
4	List of accounts	Edit: Modify the user password and permissions Delete: Delete the user account																

## 5.2.4 Setting - Video

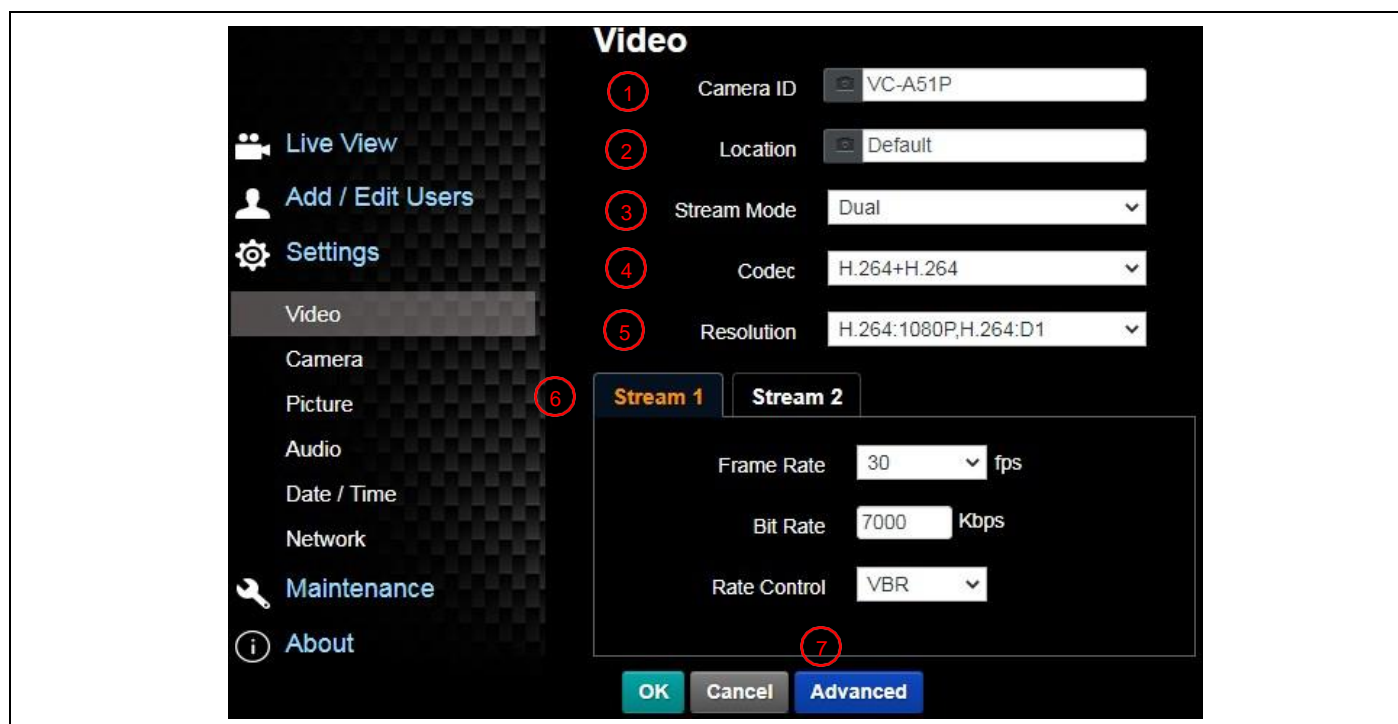

No	Item	Function Descriptions	VC-A51P	VC-A51PN
1	Camera name	Change camera name here <ul style="list-style-type: none"> <li>Camera names are limited to 1 - 11 characters</li> <li>Please use a camera name by mixing uppercase and lowercase letters or numbers. Do not use "/" and "space" or special symbols</li> </ul>	v	v
2	Camera Location	Modify the location of the camera, such as Room 1 <ul style="list-style-type: none"> <li>Camera location is limited to 1 - 11 characters</li> <li>Please use a camera name by mixing uppercase and lowercase letters or numbers. Do not use "/" and "space" or special symbols</li> </ul>	v	v
3	NDI HX	VC-A51PN can turn NDI HX on/off On: Support NDI (ONVIF cannot find devices, and RTSP/RTMP/RTMPS/MPEG-TS/SRT streams cannot be used) Off: Support RTSP/RTMP/RTMPS/MPEG-TS/SRT, and ONVIF can find devices but cannot be used with NDI Tool	v	v
4	Streaming Mode	Choose from Single/Dual stream	v	*Note 1
5	Encode	Set the encode type <ul style="list-style-type: none"> <li>H.264 + H.264 (Dual stream)</li> <li>H.264 + MJPEG (Dual stream)</li> <li>MJPEG (Dual stream)</li> <li>MJPEG (single stream)</li> </ul>	v	*Note 1
6	Resolution	Set Resolution	v	*Note 1
7	Streaming 1/Streaming 2	VC-A51P supports 2-way streaming output <ul style="list-style-type: none"> <li>Frame Rate: Setting according to the supported resolution</li> <li>Bit Rate (kbps)                Streaming 1: 64 ~ 20,000, default 7,000                Streaming 2: 64 ~ 8,000, default 1,000</li> <li>Rate Control: CBR / VBR</li> </ul>	v	*Note 1

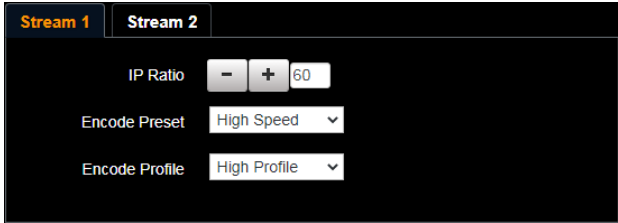
8	Advanced	 <ul style="list-style-type: none"> <li>▪ IP Ratio: IP Ratio can be set from 1 to 60 depending on the supported resolution settings</li> <li>▪ Encode Preset: <ul style="list-style-type: none"> <li>➢ <b>Auto:</b> Select between speed and quality depending on the encoding method used (e.g. HIGH_SPEED mode for refresh rate of 60 frames per second and HIGH_QUALITY mode for high image quality)</li> <li>➢ <b>HIGH_SPEED:</b> Refresh rate of 60 frames per second is available</li> <li>➢ <b>HIGH_QUALITY:</b> Higher image quality can be obtained</li> <li>➢ <b>SVC Auto:</b> SVC opened encoding mode is applicable to RTSP streaming of 8601, 8602, 8603 and 8604 ports, different refresh rate for different ports. See <a href="#">5.2.4.1 SVC description</a></li> </ul> </li> <li>▪ Encode Profile: Encoded data, support High Profile only</li> </ul>	v	<b>*Note 1</b>
---	----------	---	---	----------------

\*Note 1: Support when NDI|HX is Off

#### 5.2.4.1 SVC description:

Link Address <rtsp://VC IP Address:Port/h264>

- **60Frame:** rtsp://VC IP Address:8557/h264, E.g.: <rtsp://192.168.100.150:8557/h264>
- **30Frame:** rtsp://VC IP Address:8601/h264, E.g.: <rtsp://192.168.100.150:8601/h264>
- **15Frame:** rtsp://VC IP Address:8602/h264, E.g.: <rtsp://192.168.100.150:8602/h264>
- **7Frame:** rtsp://VC IP Address:8603/h264, E.g.: <rtsp://192.168.100.150:8603/h264>
- **3Frame:** rtsp://VC IP Address:8604/h264, E.g.: <rtsp://192.168.100.150:8604/h264>

## 5.2.5 Setting - Camera

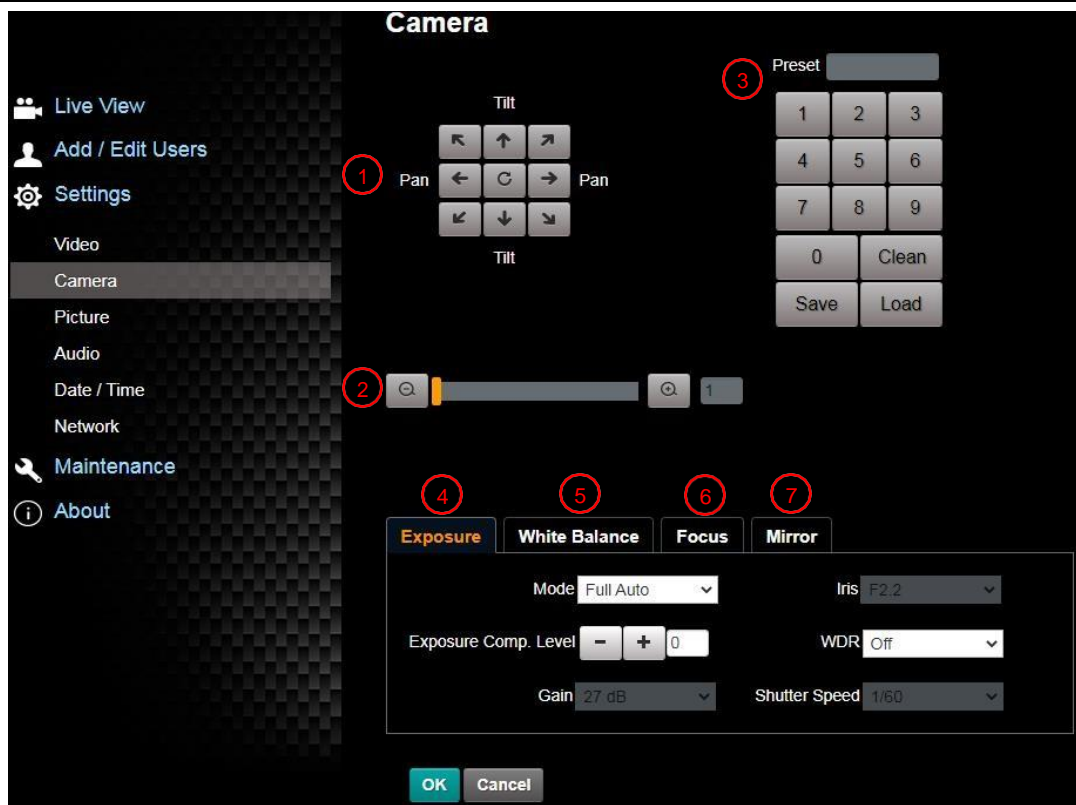

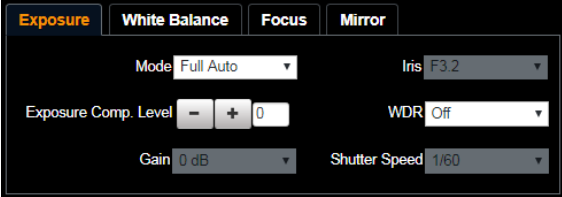
No	Item	Function Descriptions
1	Pan / Tilt setting	Adjust the Pan/Tilt position of the camera screen
2	Zoom ratio	Adjust the zoom-in or zoom-out ratio via scroll bar
3	Preset setting	Select the number first and then select SAVE or LOAD
4	Exposure	 <ul style="list-style-type: none"> <li>■ <b>Mode:</b> Select exposure mode (Automatic/Shutter Priority/Aperture Priority/Manual)</li> <li>■ <b>Exposure Comp. Level:</b> Select exposure compensation level</li> <li>■ <b>Gain:</b> The gain limit is adjustable when the exposure mode is set to “Manual”</li> <li>■ <b>Iris:</b> The size of aperture is adjustable when the exposure mode is set to “Manual” or “Aperture Priority”</li> <li>■ <b>WDR:</b> Set the level of wide dynamic range (WDR) in order to obtain better images</li> <li>■ <b>Shutter Speed:</b> The shutter speed is adjustable when the exposure mode is set to “Manual” or “Shutter Priority”</li> </ul>

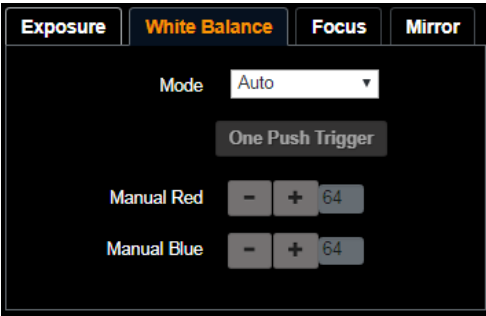
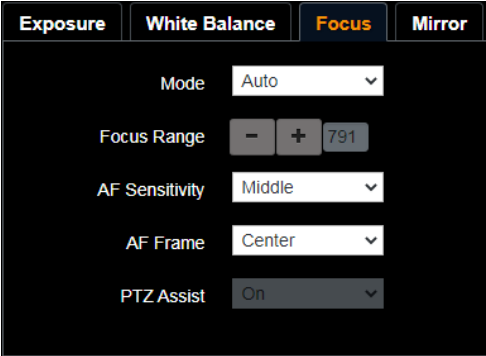
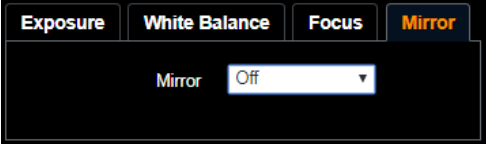
5	White Balance	 <ul style="list-style-type: none"> <li>■ <b>Mode:</b> Select the color temperature mode <ul style="list-style-type: none"> <li>➢ Auto/Indoor/Outdoor/One Push WB/ATW/Manual/Sodium Lamp/3000K/4300K/5000K/6500K/8000K/WideAuto</li> </ul> </li> <li>■ <b>Open Push WB:</b> One push color temperature is adjustable when the white balance mode is set to “One Push WB”</li> <li>■ <b>Manual Red/Blue:</b> Manually adjust blue/red color temperature</li> </ul>
6	Focus	 <ul style="list-style-type: none"> <li>■ <b>Mode:</b> Select manual/automatic focus</li> <li>■ <b>Focus Range:</b> The focusing range is adjustable when the focus mode is set to “Manual”</li> <li>■ <b>AF Sensitivity:</b> Set automatic focus sensitivity</li> <li>■ <b>AF Frame:</b> Set automatic focus range</li> <li>■ <b>Preset AF:</b> Set whether to perform auto focus after Preset</li> </ul>
7	Mirror	 <ul style="list-style-type: none"> <li>■ <b>Mirror:</b> Set the mode at which the image is mirror and flipped <ul style="list-style-type: none"> <li>➢ Off / Mirror / Flip / Mirror + Flip</li> </ul> </li> </ul>

## 5.2.6 Setting - Picture

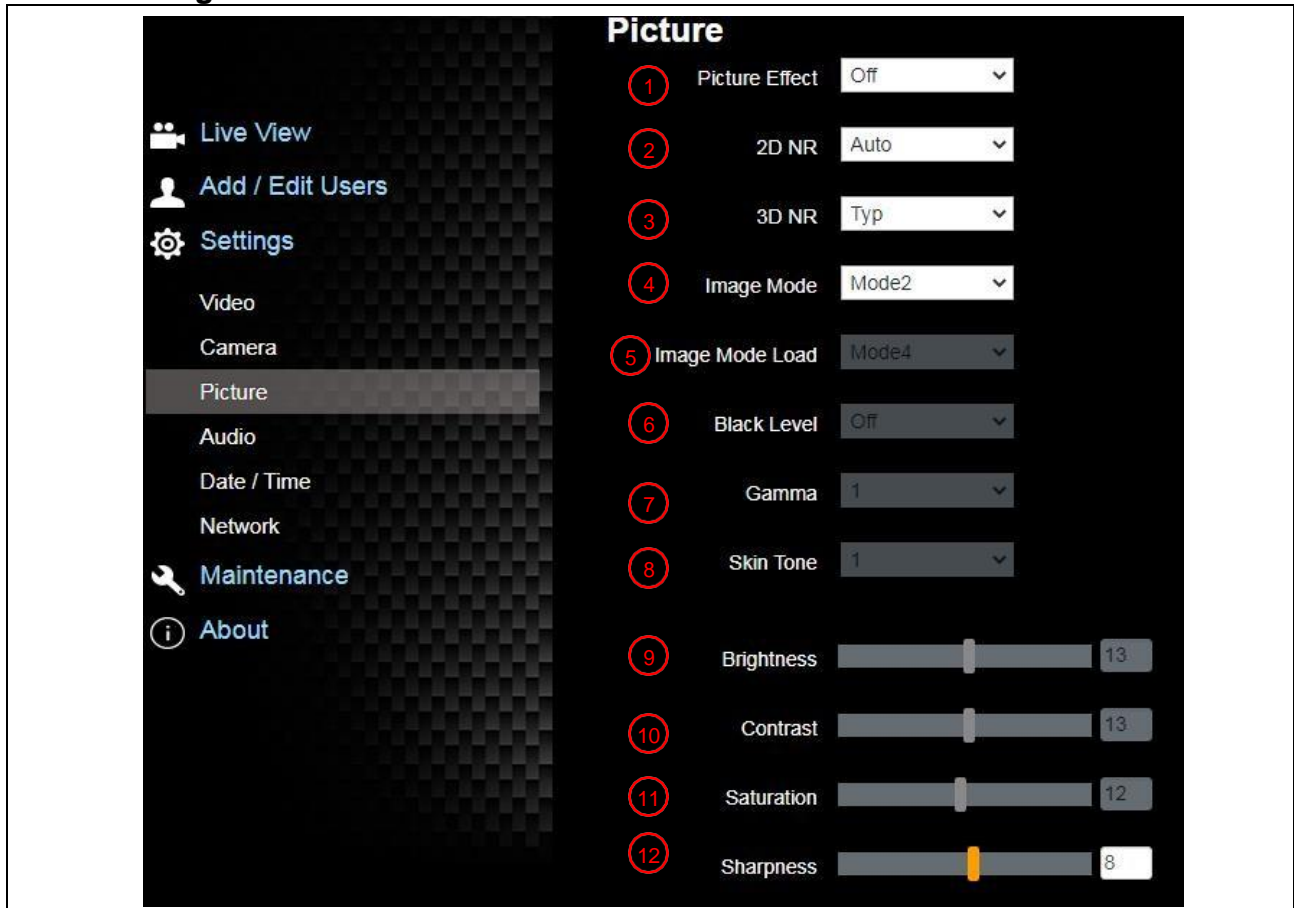

No	Item	Function Descriptions
1	Picture Effect	Set picture effect, Off/Neg/Black and White
2	2D noise reduction settings	2D noise reduction settings
3	3D noise reduction settings	3D noise reduction settings
4	Image mode	The user may customize his/her desired image mode
5	Image Mode Load	Adjustable when the Image mode is set to Custom. After selected, the corresponding Image mode parameters will be read and applied to Custom
6	Black Level	Black Level adjustment; Adjustable when the image mode is set to Custom
7	Gamma	Gamma Level adjustment; Adjustable when the image mode is set to Custom
8	Skin Tone	Skin Tone adjustment; Adjustable when the image mode is set to Custom
9	Brightness	Brightness adjustment; Adjustable when the image mode is set to Custom
10	Contrast	Contrast adjustment; Adjustable when the image mode is set to Custom
11	Saturation	Saturation adjustment of the image; Adjustable when the image mode is set to Custom
12	Sharpness	Adjust the sharpness of the image

## 5.2.7 Setting - Audio

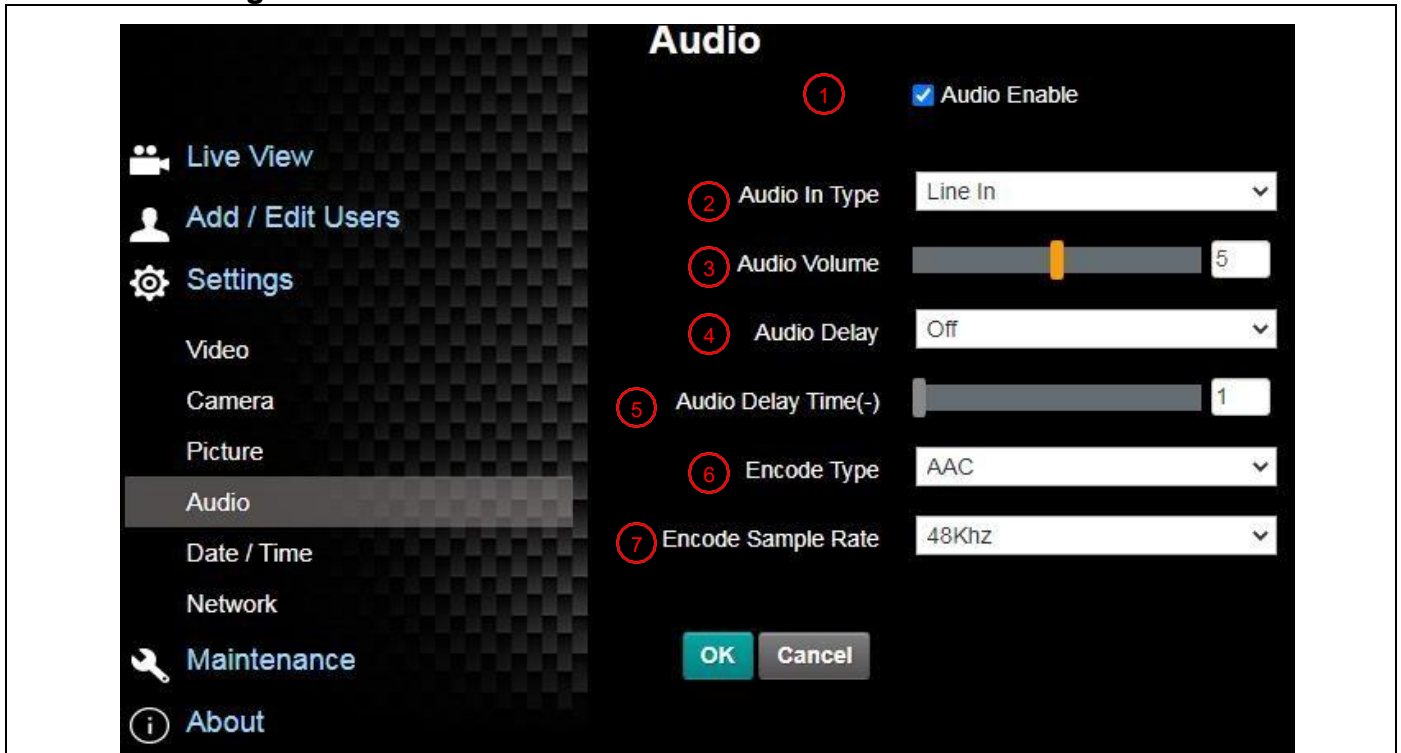

No	Item	Function Descriptions	VC-A51P	VC-A51PN
1	Open audio	Turn on/off sound	v	v
2	Soundtrack effect setting	Set MIC In/Line In	v	v
3	Volume	Adjust Volume	v	v
4	Audio delay	On / Off audio signal delay	v	*Note 1
5	Audio delay time	Set the audio signal delay time (-1 ~ -500 ms)	v	
6	Encode type	AAC / G.711	v	
7	Encode sample rate	Set Encode sample rate > 48 KHz (AAC) > 44.1 KHz (AAC) > 16 KHz (AAC) > 16 KHz (G.711) > 8 KHz (G.711) ※ VC-A51PN only supports 48 KHz (AAC)/44.1 KHz (AAC)	v	*Note 1

\*Note 1: Support when NDI|HX is Off

## 5.2.8 Set - Time

No	Item	Function Descriptions
1	Camera Time	Display the date and time of the current camera
2	Set the Time	<ul style="list-style-type: none"> <li>■ Manual Configuration: Set time manually</li> <li>■ Synchronize with computer time: Set the camera time according to the computer time</li> <li>■ Synchronize with SNTP server: Set the camera time synchronously with the SNTP server</li> </ul> <p>× SNTP server address: Please go to <a href="#">5.2.9 Settings-Network</a> to make changes</p>



## Setting - Network

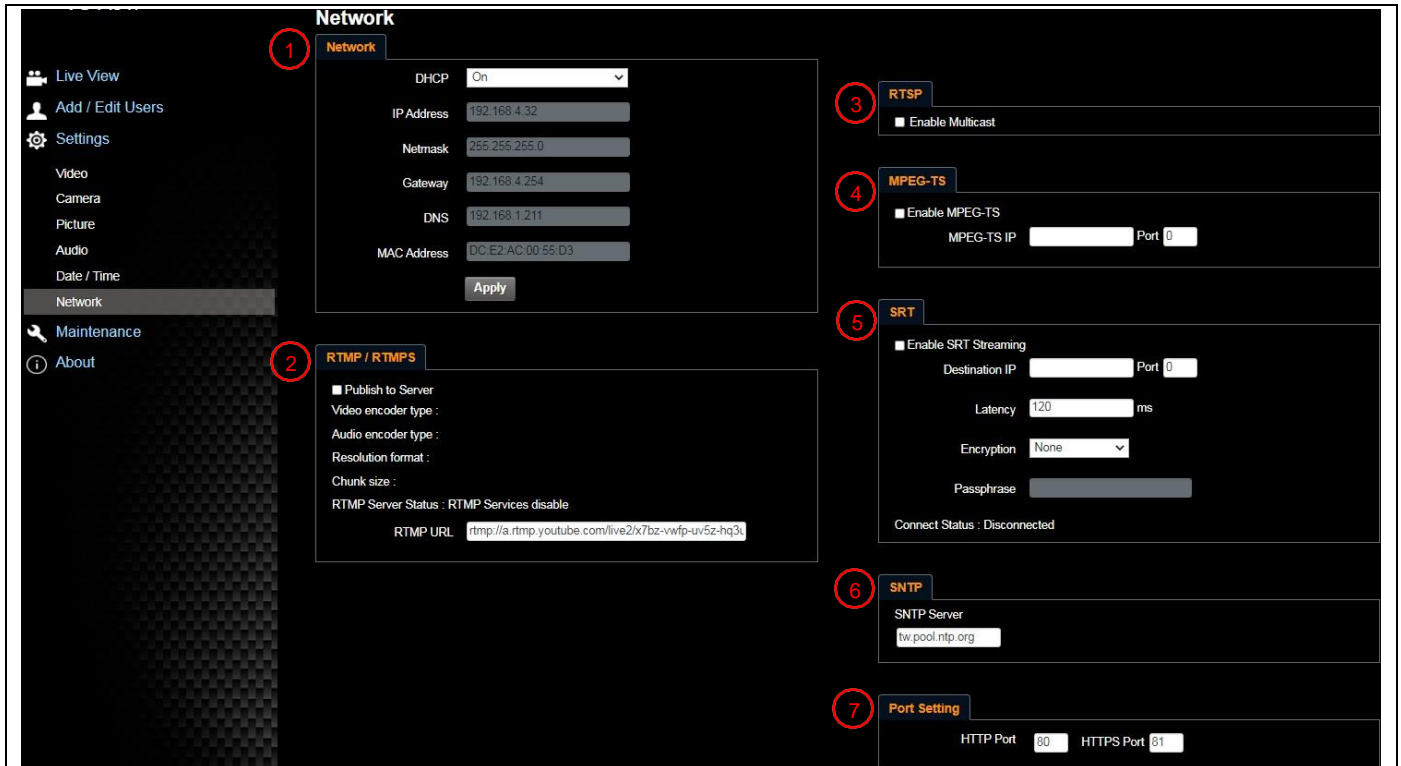

No	Item	Function Descriptions	VC-A51P	VC-A51PN
1	Network	Network setting of camera. Change of setting is available when DHCP function is closed.	v	v
2	RTMP/RTMPS Setting	Copy the RTMP web address provided by the RTMP service platform and paste it to the RTMP connection address to publish the camera images on the RTMP service platform To upload to YouTube for live streaming, please refer to <a href="#">5.2.7 Settings - Audio</a> to turn on the audio function	v	
3	RTSP Setting	Enable/Disable Multicast It is suggested to enable Multicast when the number of users online watching the image simultaneously is more than 4 <ul style="list-style-type: none"> <li>■ Enable/Disable Password Authentication                             <ul style="list-style-type: none"> <li>➤ RTSP connection format can be found in <a href="#">5.1.4 Using RTSP Players</a></li> <li>➤ The username/password is the same as the web login password of the camera, please refer to <a href="#">5.2.3 Account Management</a> to add/modify account information</li> </ul> </li> </ul>	v	*Note 1
4	MPEG-TS Setting	Set MPEG-TS format ※Port must be set in the range above 1024 with a maximum value of 9999 ※The following port is used by the camera. Setting of the port may not connect correctly 8554, 8556, 8557, 8080, 80, 81, 9090, 23	v	*Note 1

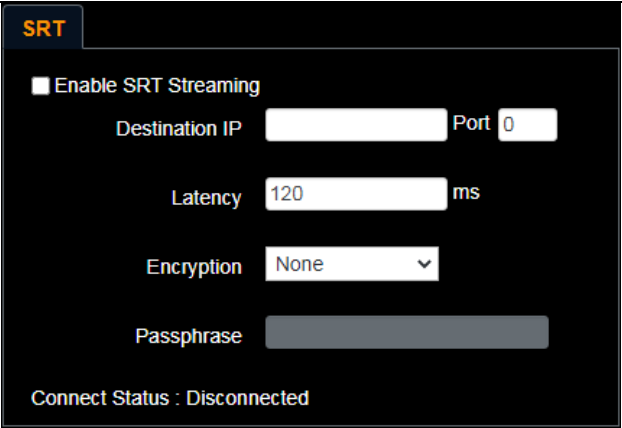
5	SRT Setting	 <p>1. Set the field of SRT and then check the item to open SRT streaming After the SRT streaming is opened, it will be connected automatically upon startup</p> <p>2. The port number must be set in the range above 1024 with a maximum value of 9999 * The following port is used by the camera. Setting of the port may not connect correctly 8554, 8556, 8557, 8080, 9090, 1935</p> <p>3. Delay time is for 20 to 8000 microseconds. The default value is 120 microseconds</p>	v	<b>*Note 1</b>
6	SNTP Setting	Set SNTP Server IP	v	v
7	Port Setting	Set HTTP port. The default Port value is 80	v	v

\*Note 1: Support when NDI|HX is Off

### 5.2.9 Setting - Maintenance - Upgrading Firmware

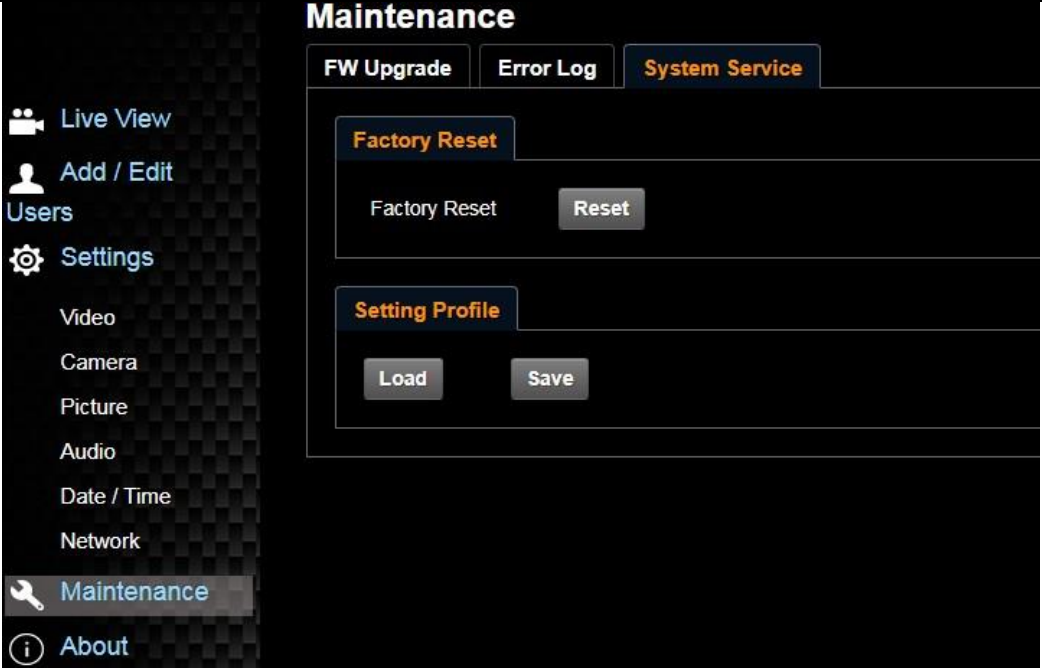
		
No	Item	Function Descriptions
1	Firmware Update	<p>The camera firmware can be updated via the web page</p> <p>Please go to the Lumens official website to download the latest firmware version and update the manual</p>

### 5.2.10 Setting - Maintenance - Incident Log

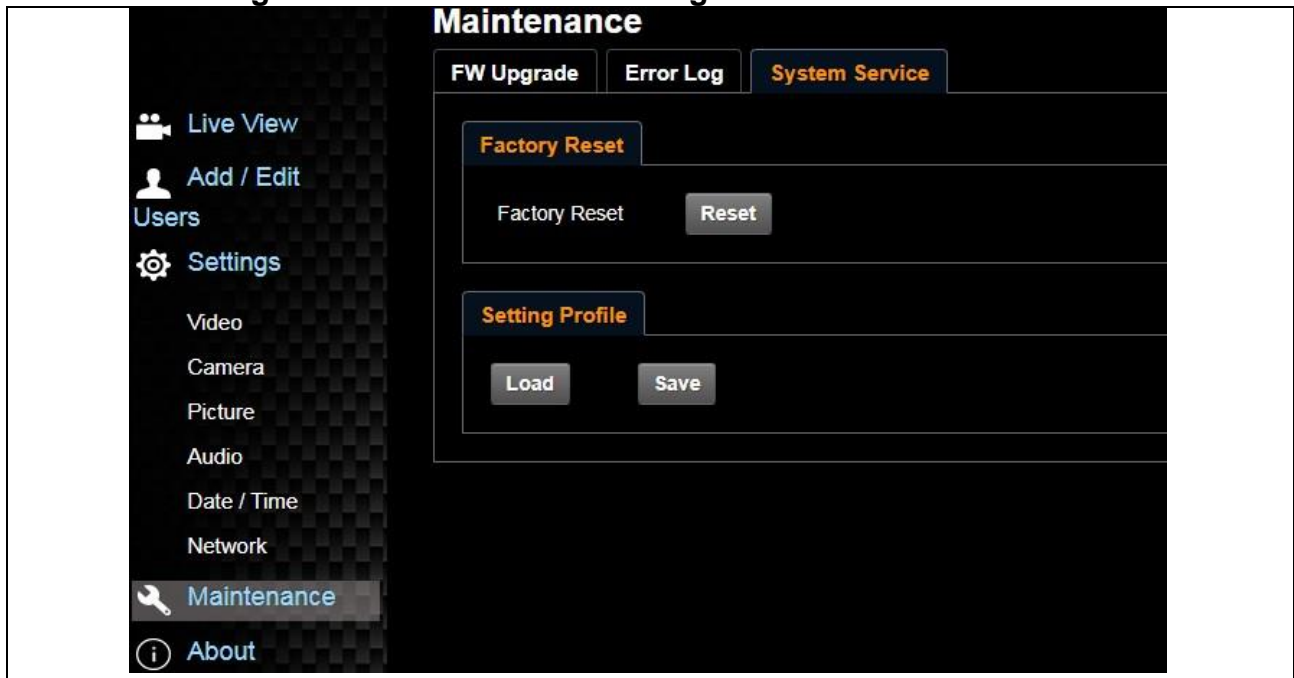

The screenshot shows the 'Maintenance' section of a web interface. The left sidebar contains options: Live View, Add / Edit Users, Settings, Video, Camera, Picture, Audio, Date / Time, Network, Maintenance (highlighted), and About. The main content area has tabs for 'FW Upgrade', 'Error Log', and 'System Service'. Under 'System Service', there are two sections: 'Factory Reset' with a 'Reset' button, and 'Setting Profile' with 'Load' and 'Save' buttons.

No	Item	Function Descriptions
1	Event Logs	If the camera encounters errors, an error code log will be established <b>&lt;Remark&gt; When an error code appears, please try to clear it to make sure whether the issue has occurred repetitively</b>

### 5.2.11 Setting - Maintenance - System Service

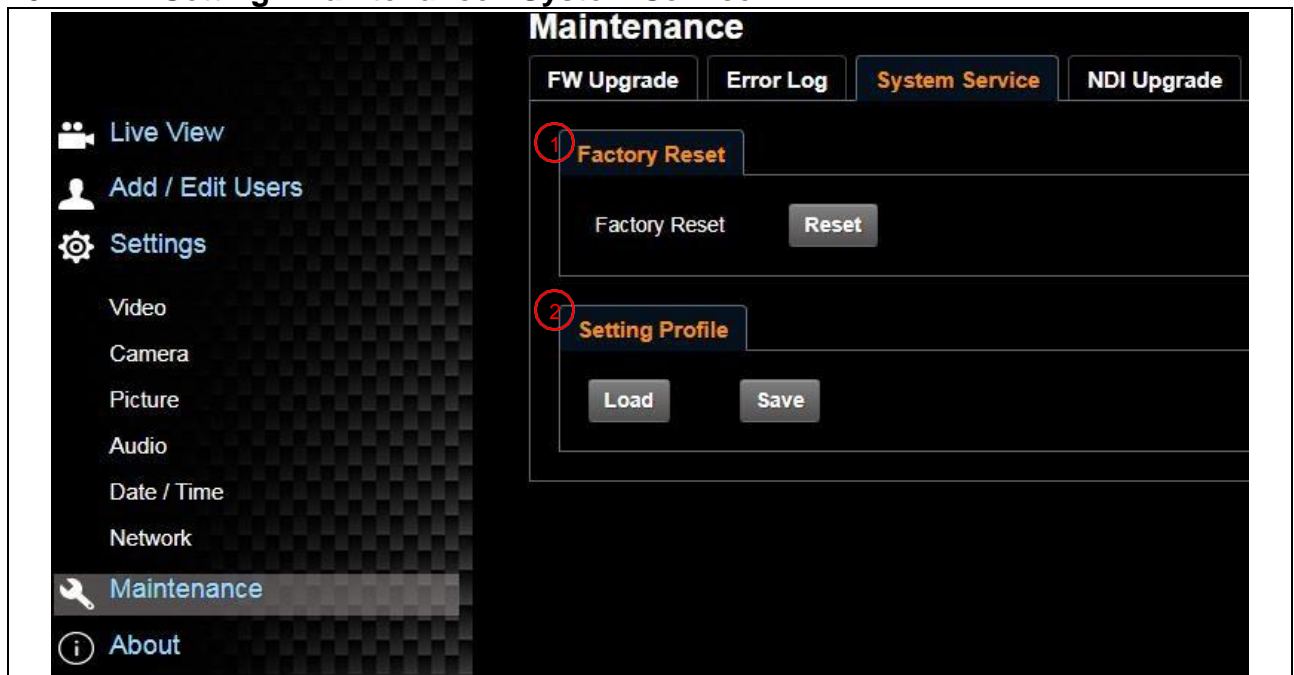

The screenshot is similar to the previous one but includes numbered callouts. Callout '1' points to the 'Factory Reset' section, and callout '2' points to the 'Setting Profile' section.

No	Item	Function Descriptions
1	Reset to the default value	Select the reset button to resume the factory default setting as the web page setting
2	Setting File	The web page setting parameters can be exported from the computer and imported/applied to another camera

## 5.2.12 About

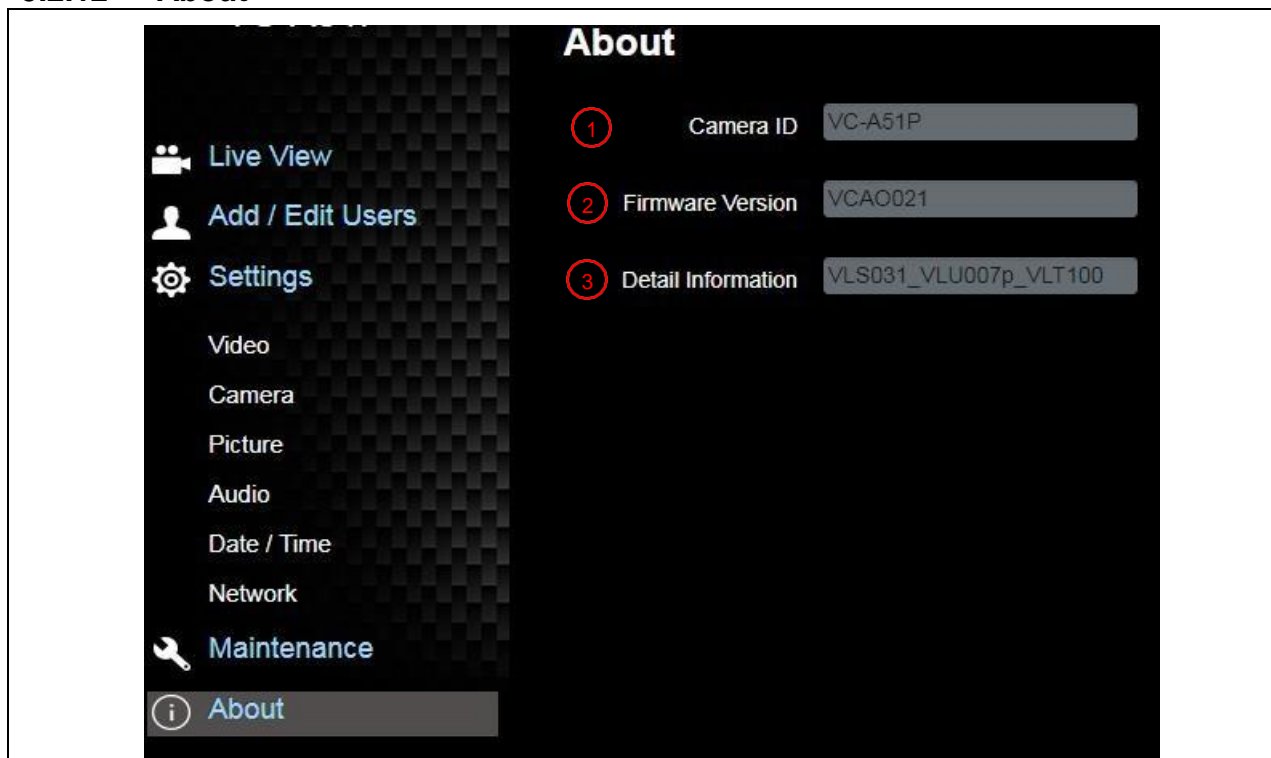

No	Item	Function Descriptions
1	Camera name	Display the current camera name
2	Firmware Version	Display the firmware version of the camera
3	Version Information	Display firmware version-related information

# Chapter 6 DIP Switch Setting

## 6.1 OUTPUT Switch

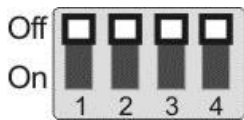

Output Mode	Setting	Output Mode	Setting
1920x1080/60p		1920x1080/50p	
1920x1080/30p		1920x1080/25p	
1920x1080/60i		1920x1080/50i	
1280x720/60p		1280x720/50p	
1080/59.94p		1080/59.94i	
1080/29.97p		720/59.94p	

## 6.2 IR SELECT



ID	Setting
1	
2	
3	

## 6.3 Camera Address Selector



Setting	Function Descriptions
0~7	ID 0~7
8~9	Reserved

## 6.4 System Switch



Setting	Function Descriptions
DIP 1	RS-232/RS-422 Communication Control OFF : RS-232 / ON : RS-422
DIP 2	IR signal output OFF : Off / ON : On
DIP 3	Communication baud rate OFF : 9600 / ON : 38400
DIP 4	Reserved

## Chapter 7 Troubleshooting

This chapter describes problems you may encounter while using VC-A51P/VC-A51PN. If you have questions, please refer to related chapters and follow all the suggested solutions. If the problem still occurred, please contact your distributor or the service center.

No.	Problems	Solutions
1.	Boot without power signal	<ol style="list-style-type: none"> <li>1. Make sure you have plugged in the power cord.</li> <li>2. When using a PoE connection, ensure that the power supply supports POE+ (IEEE 802.3at) hubs</li> </ol>
2.	There is no image output from the camera	<ol style="list-style-type: none"> <li>1. Check the power supply or PoE supply functions.</li> <li>2. Confirm the output signals are in streaming output.</li> <li>3. Confirm whether the camera resolution can be used together with the monitor equipment</li> <li>4. Replace the cables and make sure they are not faulty.</li> </ol>
3.	The Camera image is severely delayed	Please use 1080p or 720p 60/50 fps rather than 25/30 fps signals.
4.	RS-232 cannot be controlled	<ol style="list-style-type: none"> <li>1. Confirm the connection is correct (RS-232 In/ Out)</li> <li>2. Please make sure the Baud rate setting is the same as the control equipment</li> </ol>
5.	Whether the Internet can be used for operation	Please refer to <a href="#">Chapter 5 Network Function Description</a> for the Internet usage
6.	The ONVIF software cannot find the machine	<p>Please make sure that [Setting]&gt; [Video]&gt; [Camera ID]/[Location] in the web page uses only English letters or numbers. The ONVIF software cannot find the machine if you use special characters and space.</p> <p>For VC-A51PN, ONVIF is supported only after NDI HX is turned off. Please make sure <b>[Setting]&gt;[Video]&gt;[NDI HX]</b> is set to <b>[Off]</b> in the webpage.</p>
7.	<b>Tally light is not working when applying RS232 setting</b>	<p>Please make sure if the <b>Tally lamp</b> function is enabled from the setting menu or web page.</p> <p>Setting Menu: <b>System - Tally Lamp</b></p>
8.	<b>The camera does not save the relevant parameters (PTZ, AWB ...) after reboot</b>	<p>Please make sure if the <b>Initial Position</b> is set to <b>Last Operated Position</b> from the setting menu or web page</p> <p>Setting Menu: <i>System - Initial Position</i></p>

# Chapter 8 Safety Instructions

Always follow these safety instructions when using the product:

## 1 Operation

- 1.1 Please use the product in the recommended operating environment, away from water or source of heat.
- 1.2 Do not place the product in tilted position or unstable trolley, stand or table.
- 1.3 Please clean the dust on the power plug prior to usage. Do not insert the product's power plug into a multiplug to prevent sparks or a fire.
- 1.4 Do not block the slots and openings in the case of the product. They provide ventilation and prevent the product from overheating.
- 1.5 Do not open or remove covers, otherwise it may expose you to dangerous voltages and other hazards. Refer all servicing to licensed service personnel.
- 1.6 Unplug the product from the wall outlet and refer servicing to licensed service personnel when the following situations happen:
  - If the power cords are damaged or frayed.
  - If liquid is spilled into the product or the product has been exposed to rain or water.

## 2 Installation

- 2.1 For security considerations, please make sure the standard hanging rack you bought is in line with UL or CE safety approbations and installed by technician personnel approved by agents.

## 3 Storage

- 3.1 Do not place the product where the cord can be stepped on as this may result in fraying or damage to the lead or the plug.
- 3.2 Unplug the product during thunderstorms or if it is not going to be used for an extended period.
- 3.3 Do not place the product or accessories on top of vibrating equipment or heated objects.



## 4 Cleaning

- 4.1 Disconnect all the cables prior to cleaning and wipe the surface with a dry cloth. Do not use alcohol or volatile solvents for cleaning.

## 5 Batteries (for products or accessories with batteries)

- 5.1 When replacing batteries, please only use similar or the same type of batteries.
- 5.2 When disposing of batteries or products, please adhere to the relevant instructions in your country or region for disposing of batteries or products.

### ■ Precautions

	This symbol indicates that this equipment may contain dangerous voltage which could cause electric shock. Do not remove the cover (or back). No user-serviceable parts inside. Refer servicing to licensed service personnel.		This symbol indicates that there are important operating and maintenance instructions in this User Manual with this unit.
---	---	---	---

### ■ FCC Warning

This equipment has been tested and found to comply with the limits for a Class A digital device, pursuant to part 15 of the FCC Rules. These limits are designed to provide reasonable protection against harmful interference when the equipment is operated in a commercial environment.

Notice :

The changes or modifications not expressly approved by the party responsible for compliance could void the user's authority to operate the equipment..

This equipment has been tested and found to comply with the limits for a Class A digital device, pursuant to part 15 of the FCC Rules. These limits are designed to provide reasonable protection against harmful interference when the equipment is operated in a commercial environment.

### ■ IC Warning

This digital apparatus does not exceed the Class A limits for radio noise emissions from digital apparatus as set out in the interference-causing equipment standard entitled "Digital Apparatus," ICES-003 of Industry Canada. Cet appareil numérique respecte les limites de bruits radioélectriques applicables aux appareils numériques de Classe A prescrites dans la norme sur le matériel brouilleur: "Appareils Numériques," NMB-003 édictée par l'Industrie.

### ■ EN55032 CE Warning

Operation of this equipment in a residential environment could cause radio interference.

Warning: Operation of this equipment in a residential environment may cause radio interference

# Supplier's Declaration of Conformity 47 CFR § 2.1077 Compliance Information

**Manufacturer:** Lumens Digital Optics Inc.

**Product Name:** VC-A51P/ VC-A51PN

**Model Number:** PTZ Video Camera

## Responsible Party – U.S. Contact Information

**Supplier :** Lumens Integration, Inc.

4116 Clipper Court, Fremont, CA 94538, United States

**e-mail :** support@mylumens.com

## FCC Compliance Statement

This device complies with Part 15 of the FCC Rules. Operation is subject to the following two conditions : (1) This device may not cause harmful interference, and (2) this device must accept any interference received, including interference that may cause undesired operation.



## Copyright Information

---

Copyrights © Lumens Digital Optics Inc. All rights reserved.

Lumens is a trademark that is currently being registered by Lumens Digital Optics Inc.

Copying, reproducing or transmitting this file is not allowed if a license is not provided by Lumens Digital Optics Inc. unless copying this file is for the purpose of backup after purchasing this product.

In order to keep improving the product, Lumens Digital Optics Inc. hereby reserves the right to make changes to product specifications without prior notice. The information in this file is subject to change without prior notice.

To fully explain or describe how this product should be used, this manual may refer to names of other products or companies without any intention of infringement.

Disclaimer of warranties: Lumens Digital Optics Inc. is neither responsible for any possible technological, editorial errors or omissions, nor responsible for any incidental or related damages arising from providing this file, using, or operating this product.