

**QNAP**

# TS-253E / TS-453E

**Intel® J6412 Quad-Core Long-Term Availability NAS for Business and Professional Users**

Provides dual-port 2.5 GbE, 4K HDMI dual-screen output, and dual M.2 PCIe SSD expansion slots

intel.  
CELERON®

4K  
HDMI

2.5GbE

M.2 SSD

8GB  
RAM



TS-253E

TS-453E

# Post-epidemic accelerates enterprise transformation, sustainability and maintenance will be the key

「 This is a year for global corporate information leaders to plan for the future . 」 John-David Lovelock , Vice President of Research at Gartner Inc said.

Affected by the epidemic in recent years, work modes have become more diverse and flexible, and many companies have also begun to think about how to make IT assets more flexible and to overcome time and location constraints for flexible configuration.

**TS-253E / TS-453E can be supplied stably until 2029**, providing SMB with flexible deployment according to staged needs.

Source : Commercial Times (<https://reurl.cc/M0EO2K>)



**TS-253E**



**TS-453E**

# SSD prices are expected to fall, improving storage performance is now

## SSD become popularization, upgrade now !

The cost per GB of storage for SSDs continues to decline, and the storage capacity continues to grow. In addition, SSD provides better storage performance compared to traditional hard drives.



| Type                        | 3Q22F               |
|-----------------------------|---------------------|
| Enterprise SSD              | Expected to be flat |
| Client SSD                  | decline 3~8%        |
| 3D NAND Wafers (TLC & QLC ) | decline 5~10%       |
| Total NAND Flash            | decline 0~5%        |

Source : TrendForce, 2022.06

# TS-253E / TS-453E NAS Main Features



## Long-term availability NAS

Stable long-term availability until 2029



## Dual 2.5 GbE ports

Sufficient 2.5 GbE network bandwidth for smooth data transfer experience



## Dual M.2 PCIe SSD expansion slots

Optimum configuration of SSD and HDD



## Dual 4K HDMI ports

Provide dual-port screen output for monitoring or A/V needs



## 8 GB RAM on board

Sufficient memory makes NAS applications more flexible



## Quad - core processor

Intel Celeron J6412 4-core burst 2.6 GHz processor, supports various applications of NAS

# Powered by Intel Celeron J-series high-efficiency Quad-core processors

**Intel J6412 quad-core processor, burst frequency up to 2.6GHz, and support AES-NI encryption**

## CPU Specifications

|                          |         |
|--------------------------|---------|
| Total Cores              | 4       |
| Total Threads            | 4       |
| Burst Frequency          | 2.60GHz |
| Processor Base Frequency | 2.00GHz |

## Processor Graphics

Intel® UHD Graphics for 10th Gen Intel® Processors, support 4K output

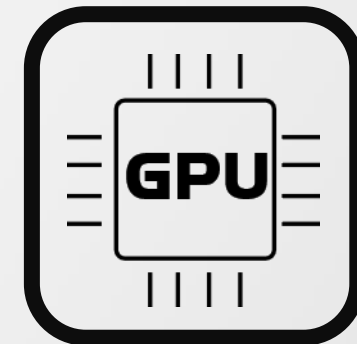

# Outperforms competing products in the same class with a built-in 8 GB onboard memory

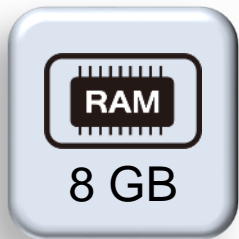

## TS-253E / TS 453E built-in 8GB large capacity memory

Compared to comparable NAS that generally use lower-capacity memory to save cost, TS-253E / TS 453E are designed with 8 GB large-capacity memory, which can make the overall NAS more smoothly.



## QVR Elite

Includes 2 Free Channels



## Snapshots

Support up to 1024



Run more apps  
through App Center



# Dual 2.5 GbE high-speed network ports



## Dual 2.5 GbE ports \*

Provide up to 5Gbps data transfer capability through Port Trunking network aggregation.

\*Also compatible with 1GbE & 100MbE

## High-speed transmission with CAT 5e

|      | CAT 5e | CAT 6  | CAT 6A |
|------|--------|--------|--------|
| 100M | ✓      | ✓      | ✓      |
| 1G   | ✓      | ✓      | ✓      |
| 2.5G | ✓      | ✓      | ✓      |
| 5G   | ✓      | ✓      | ✓      |
| 10G  | X      | ✓(55m) | ✓      |

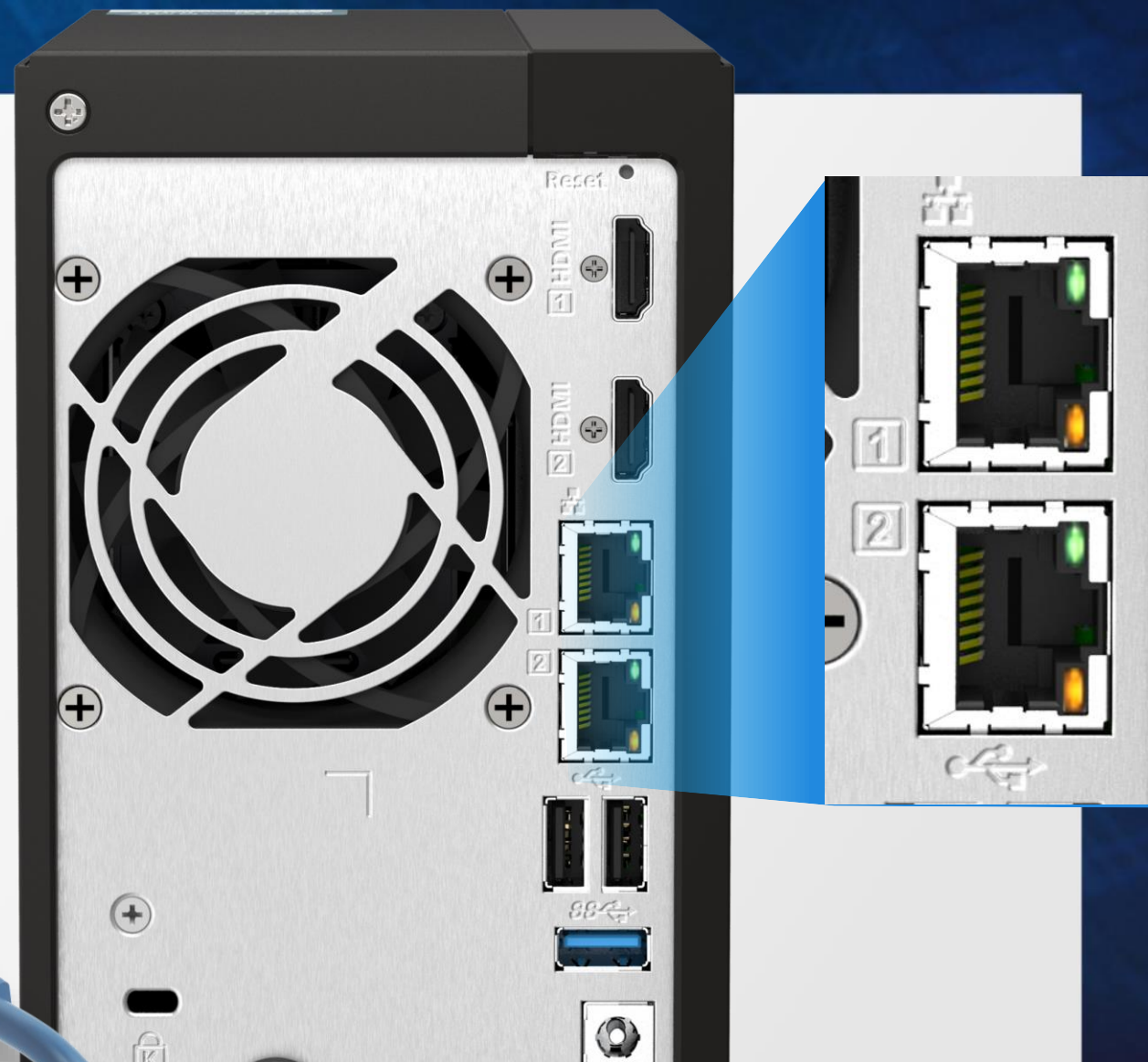

# TS-253E / TS-453E front view

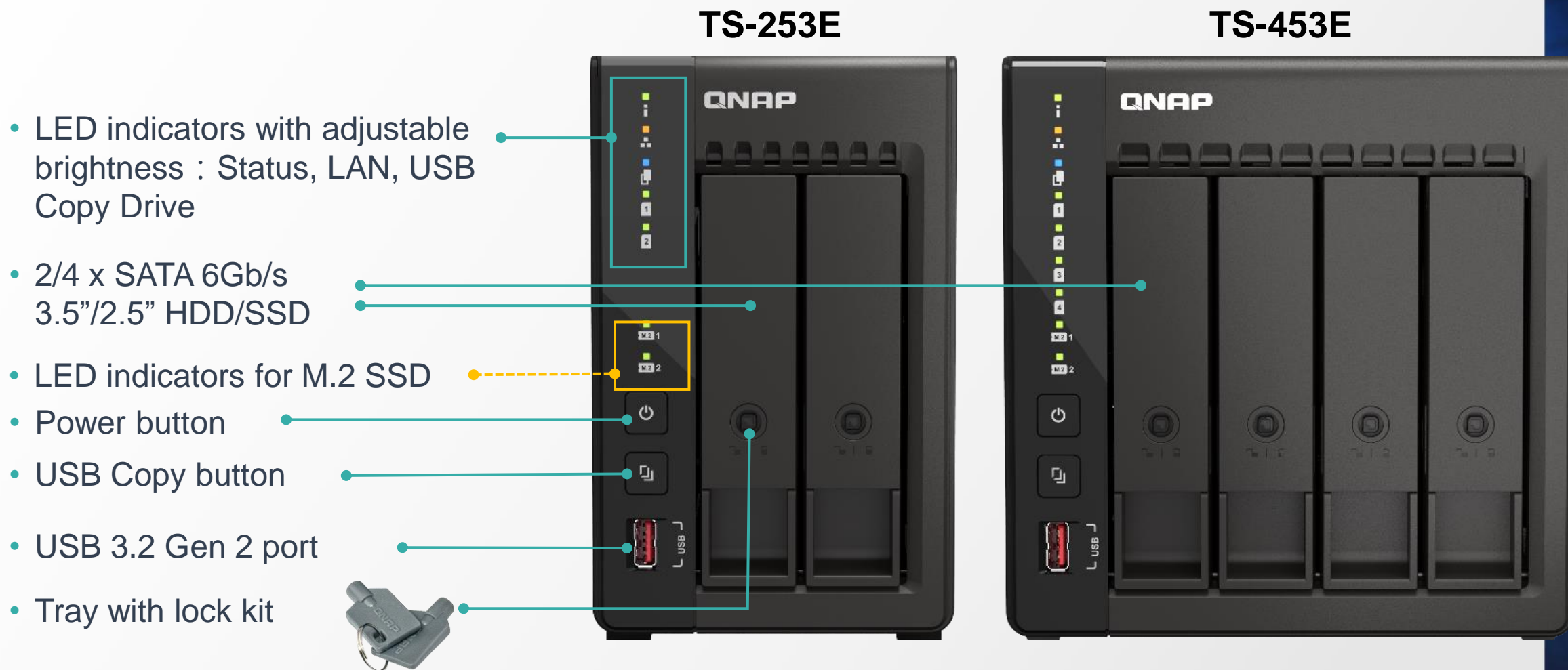



# Installing 2.5" / 3.5" SATA HDD or SSD

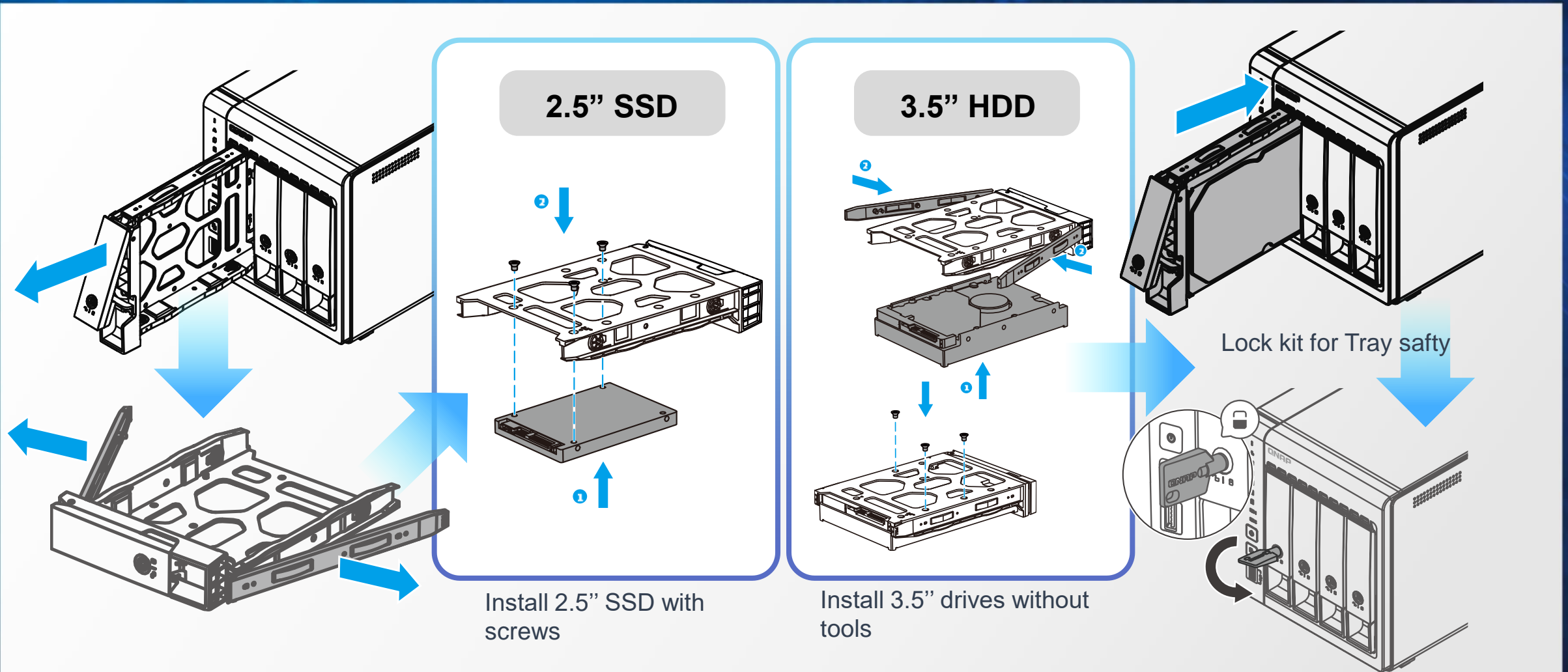

# Attain greater NAS performance by installing M.2 2280 NVMe PCIe SSDs (sold separately)

## Dual M.2 2280 PCIe Gen3 x2 slots Support NVMe SSD

providing SSD cache, and Qtier automatic tiered storage, so that SSD and HDD storage space can achieve the best configuration at any time.



# M.2 NVMe SSD cache for improved performance at a lower cost

- Especially useful for RAID 5/6 and applications dealing with small files or concurrent user access.
- TS-253E / TS-453E onboard 8 GB RAM , provide 16TB SSD cache volume

**Improves I/O latency** For IOPS-demanding apps

**Global SSD cache** Can share a single SSD volume/RAID with all volumes/iSCSI LUNs for a read-only or read-write cache.

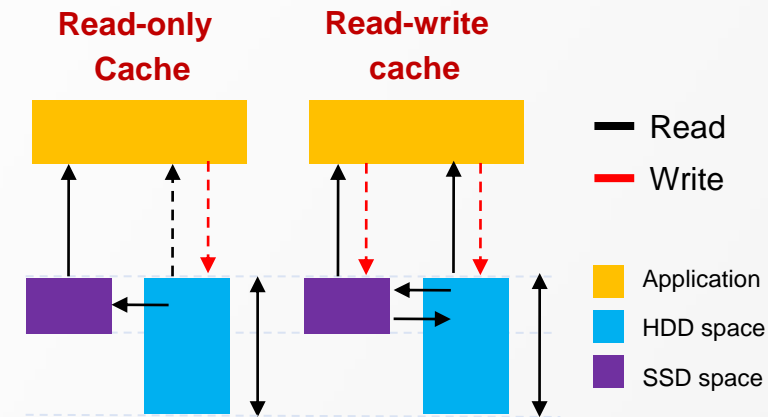

**Total capacity = HDD capacity**

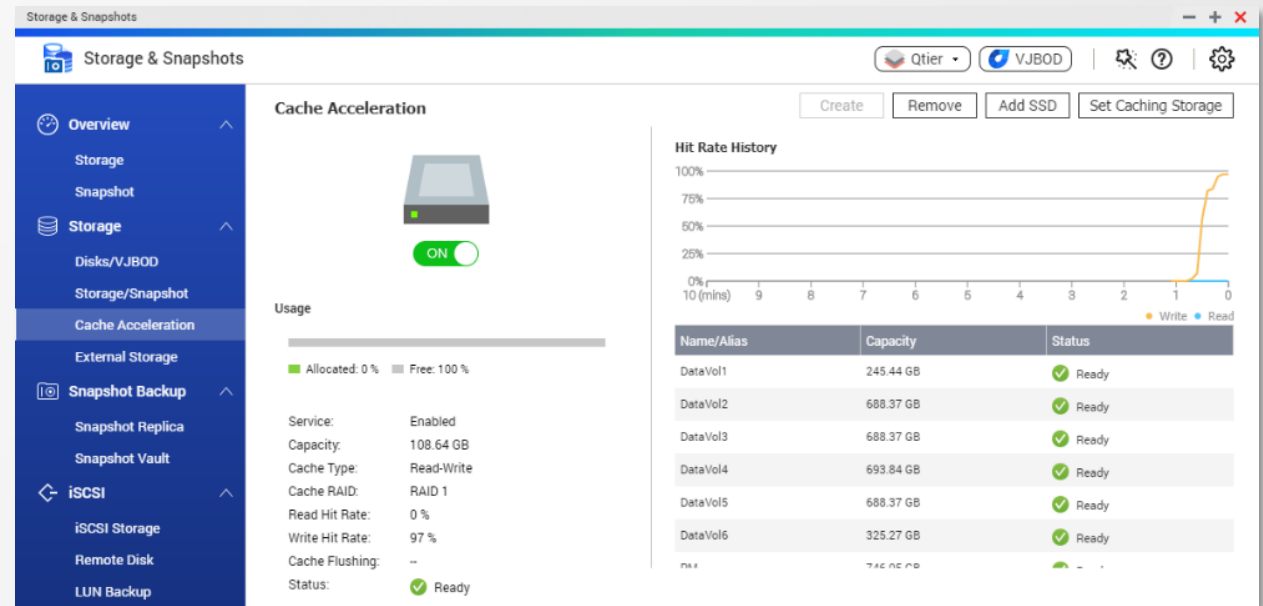

# Qtier™ Drives Auto-Tiering constantly optimize data across storage tiers

**Qtier Engine**

- Hot data
- Warm data
- Cold data

- Automatically moves hot data to high-performance drives and cold data to lower-cost, higher-capacity drives.
- Unlike SSD cache, the SSD capacity in Qtier can be used to store data.

01

**Before tiering**  
Frequently accessed data is not optimized



02

**Start data tiering**



03

**After tiering**  
Data is optimized

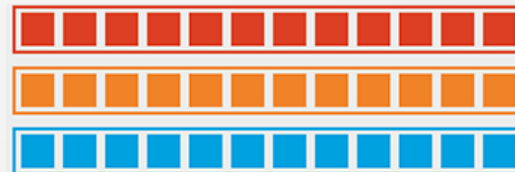

04

**Changes in data access pattern**



# Installing M.2 2280 NVMe PCIe SSD

## Step 1

Unscrew and take off casing

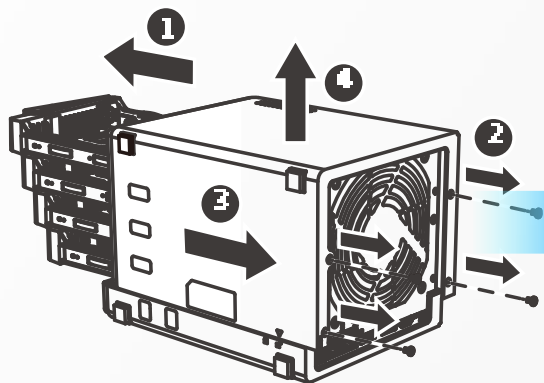

TS-453E

## Step 2

Install M.2 SSD at 45 degree angle

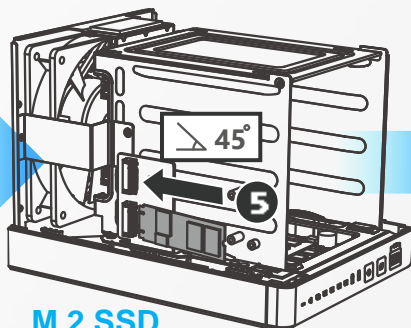

M.2 SSD

## Step 3

Screw M.2 SSD on the slot

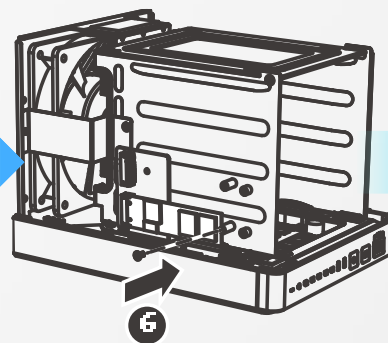

## Step 4

Put back the casing

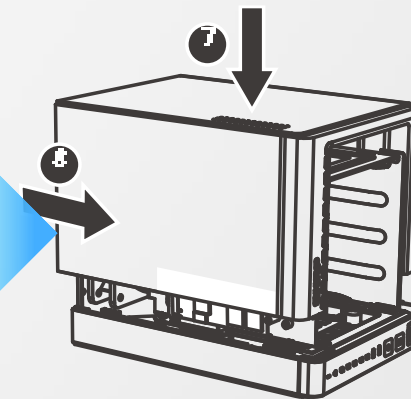

TS-253E

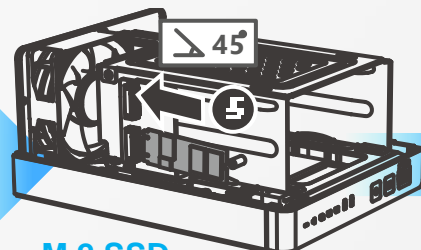
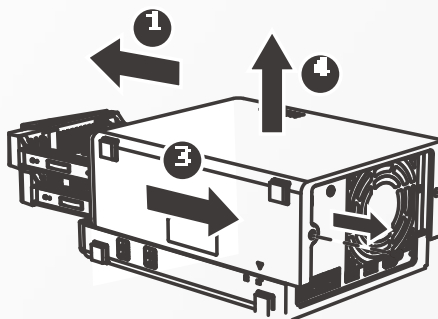

M.2 SSD

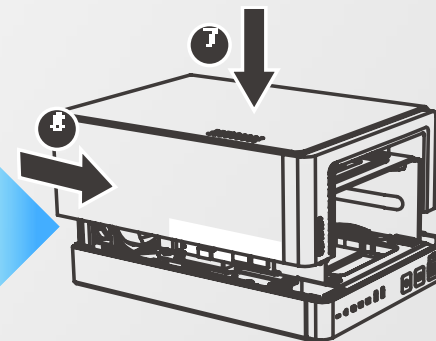
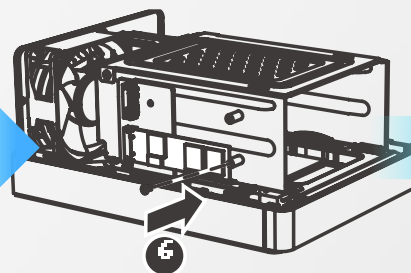

# TS-253E / TS-453E rear view

## TS-453E

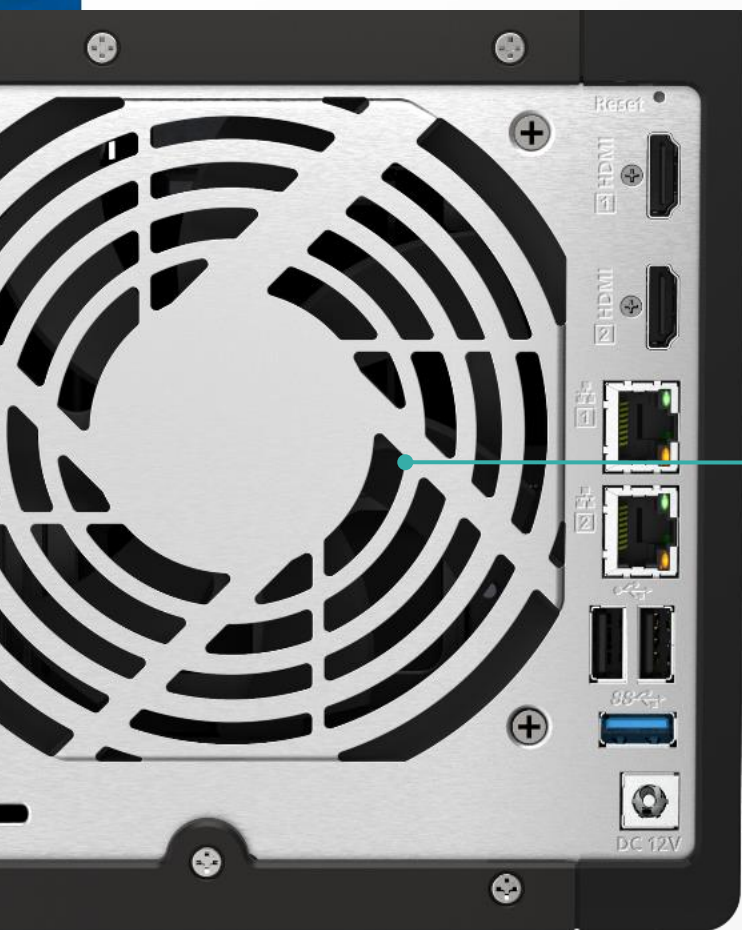

7CM  
Smart fan

12CM  
Smart fan

K-Lock

## TS-253E



2 x HDMI 1.4b

2 x 2.5 Gigabit Ethernet  
port

2 x USB 2.0 port

USB 3.2 Gen 2 port

12V DC power input

# Optional Support USB JBOD & RAID Storage Expansion Unit



**TR-002**

2-bay  
Desktop SATA 6Gb/s JBOD  
Support hardware RAID



**TR-004**

4-bay  
Desktop SATA 6Gb/s JBOD  
Support hardware RAID



**TL-D800C**

8-bay  
Desktop USB 3.2 Gen 2 JBOD



**TR-004U**

4-bay  
Rackmount USB 3.2 Gen 1 JBOD  
Support hardware RAID



**TL-R1200C-RP**

12-bay  
Rackmount USB 3.2 Gen 2 JBOD  
Support dual power backup

## Maximum of JBOD / RAID expansion enclosures

|              |   |
|--------------|---|
| TR-002       | 2 |
| TR-004       | 2 |
| TR-004U      | 2 |
| TL-D800C     | 1 |
| TL-R1200C-RP | 1 |

# 1 x 2.5GbE for 10GB file transfer performance

1 x 2.5GbE Windows file transfer (10GB)

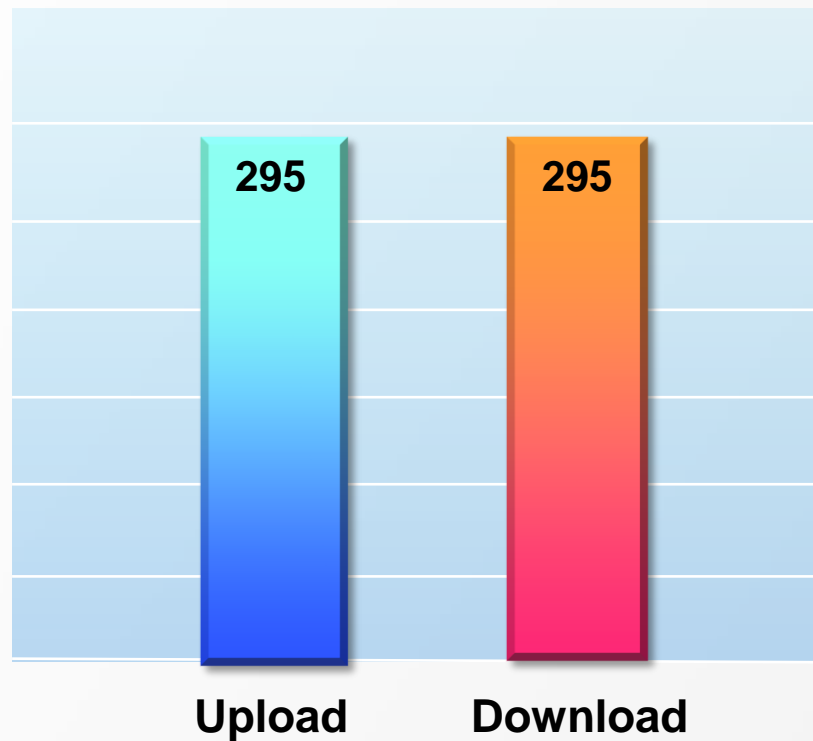

1 x 2.5GbE Windows file transfer (10GB)  
NAS encrypted volume

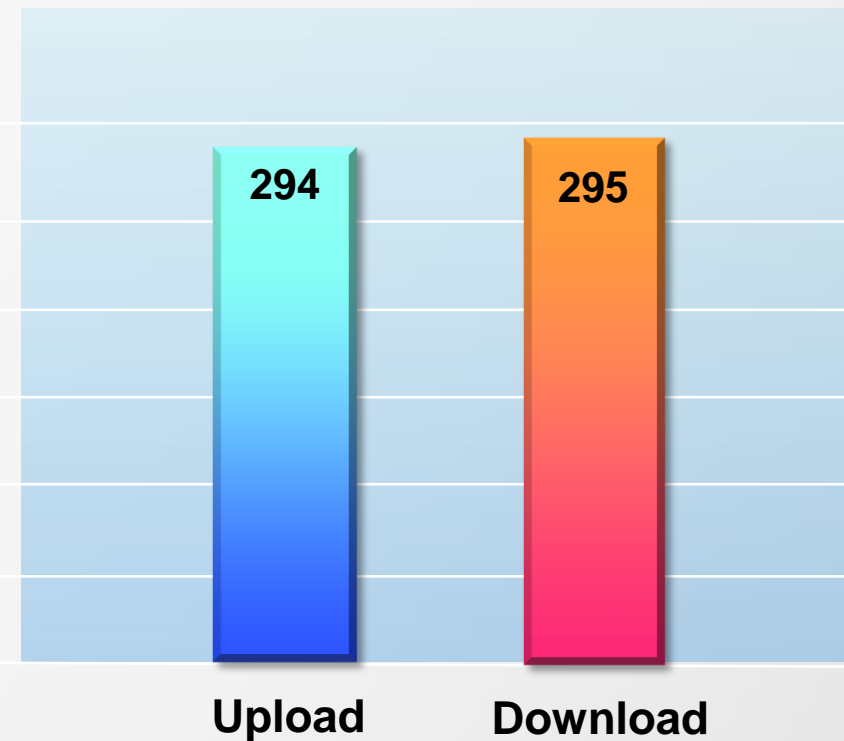

Environment:  
NAS | TS-453E, QTS 5.0, 4 x Samsung 860 Pro 512GB, RAID 5, thick volume  
PC | Windows Server 2016 Standard, Intel Core i7-6700 3.4 GHz, 64GB RAM

Tested in QNAP Labs. Figures may vary by environment.



# 2 x 2.5GbE for 10GB file transfer performance

2 x 2.5GbE Windows file transfer (10GB)

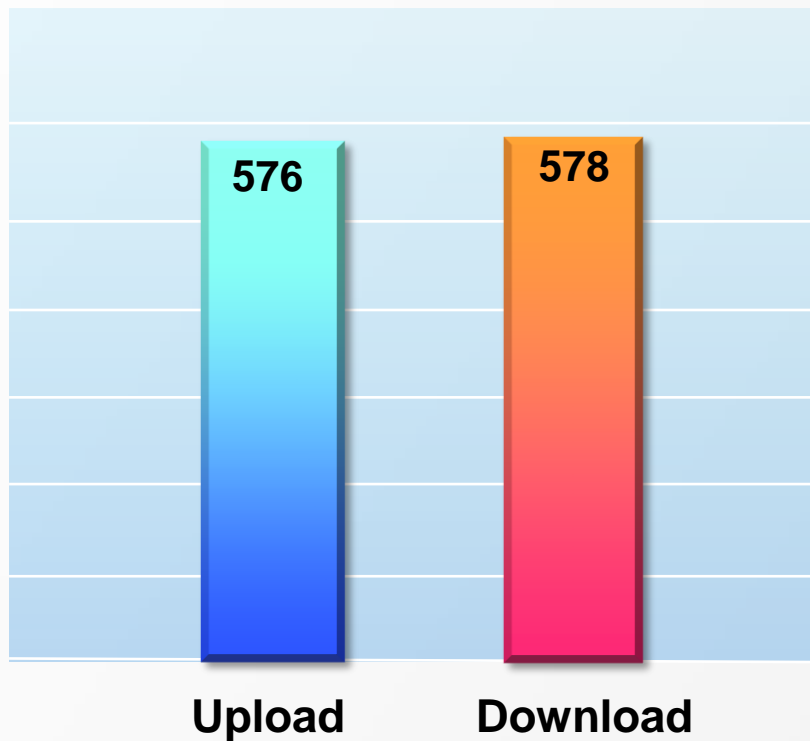

2 x 2.5GbE Windows file transfer (10GB)  
NAS encrypted volume

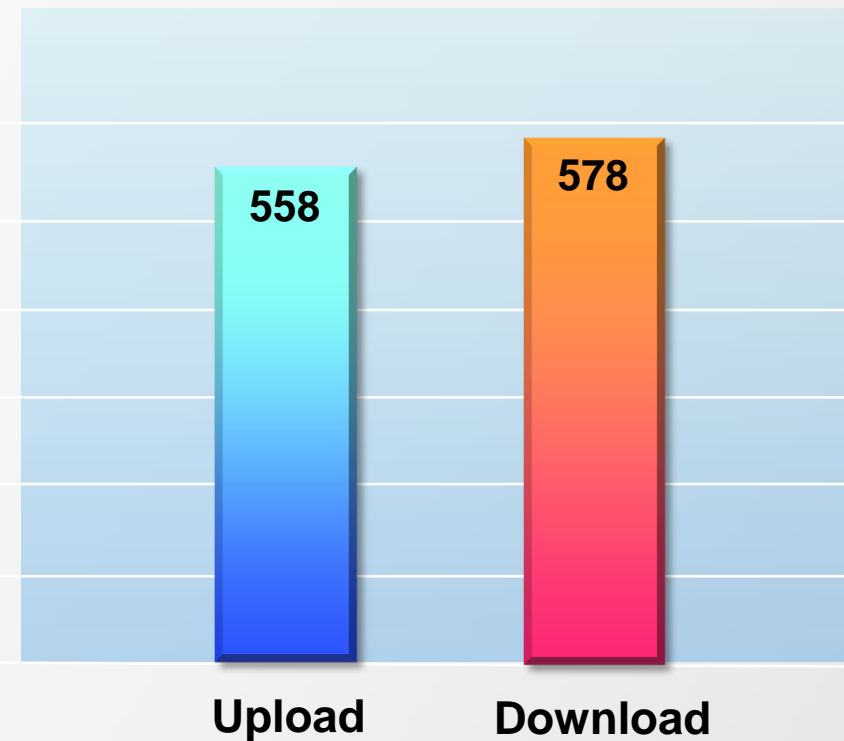

Environment:  
NAS | TS-453E, QTS 5.0, 4 x Samsung 860 Pro 512GB, RAID 5, thick volume  
PC | Windows Server 2016 Standard, Intel Core i7-6700 3.4 GHz, 64GB RAM

Tested in QNAP Labs. Figures may vary by environment.



# TS-253E / TS-453E

Live Demo





# TS-253E / TS-453E

## Software Introduction



# Equipped with the latest QTS 5.0 NAS operating system

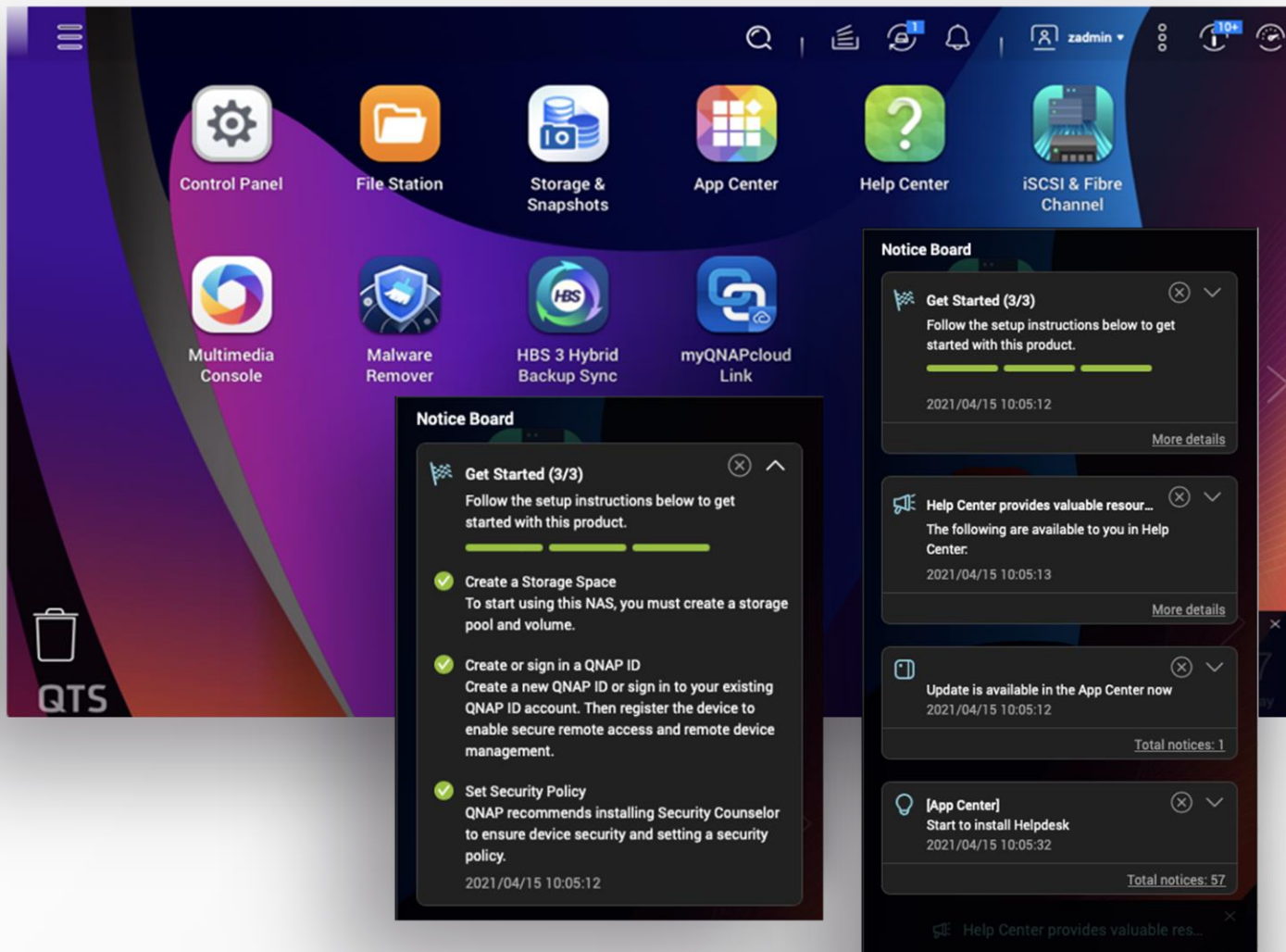

- New Linux Kernel 5.10 improved security
- Smooth and reactive user interface
- Increased NVMe SSD cache performance
- Supports WireGuard VPN

# Windows Search Protocol (WSP) support for NAS shared folders

Windows® 10/ Windows Server® 2016 (or later) users can easily search NAS shared folders via Windows® when an SMB drive is mounted to the NAS. Advanced file search by time, file type, or size is supported for greater convenience.

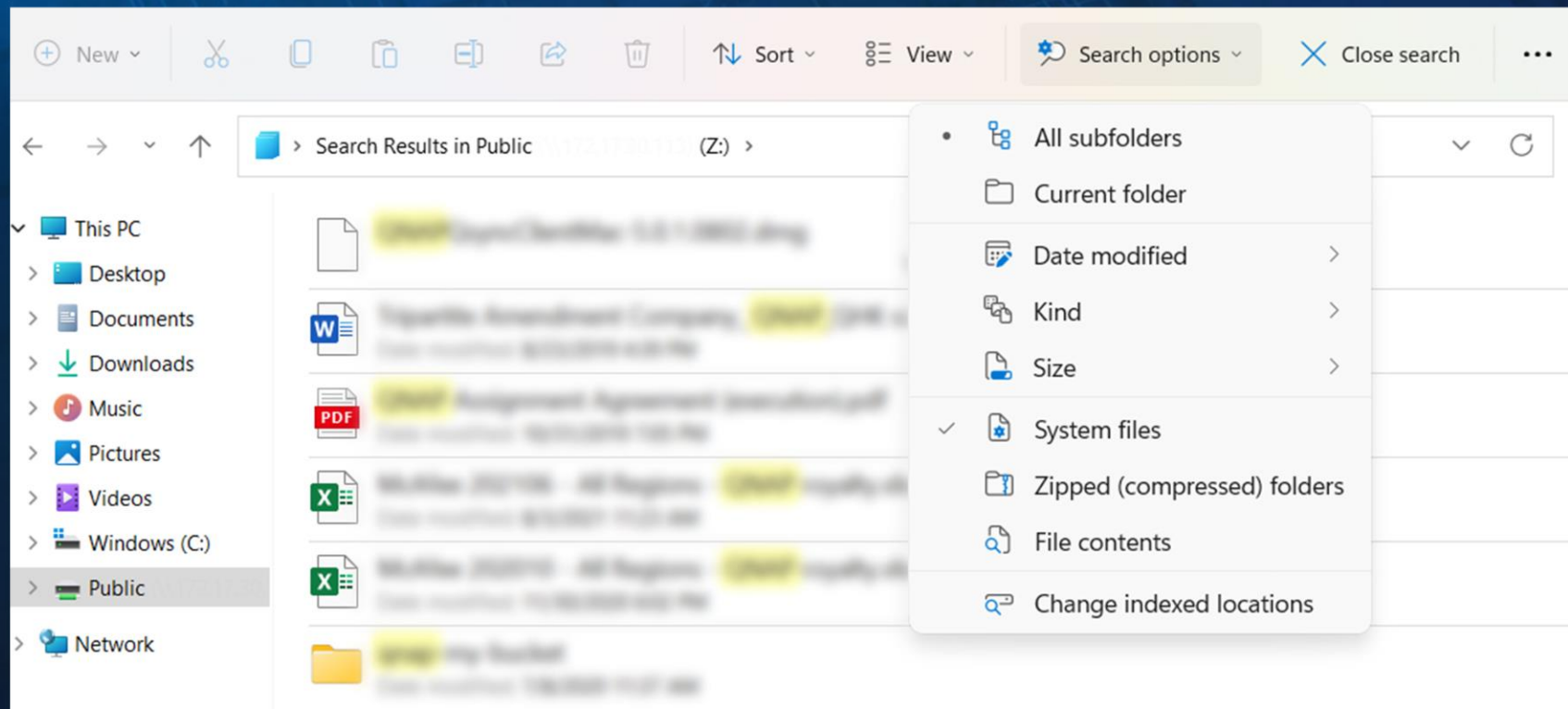

# TS-253E / TS-453E natively supports exFAT

From QTS version 5.0, exFAT is natively supported free of charge on TS-253E / TS-453E . exFAT is a file system optimized for flash storage (such as SD cards and USB devices) and helps accelerate large media file transfer.

| File System       | exFAT   | NTFS                            | FAT32  |
|-------------------|---|---------------------------------|--|
| Maximum File Size | 16EB  | 16TB                            | 4GB  |
| Typical Usage     | Next-generation USB drives and SD cards (such as SDXC) that require higher capacities and faster speeds | The file system used by Windows | The standard file system used by normal USB drives |

# Faster image identification with integrated Intel® OpenVINO™ AI engine.



## QuMagie

Organize photos with similar faces using facial recognition

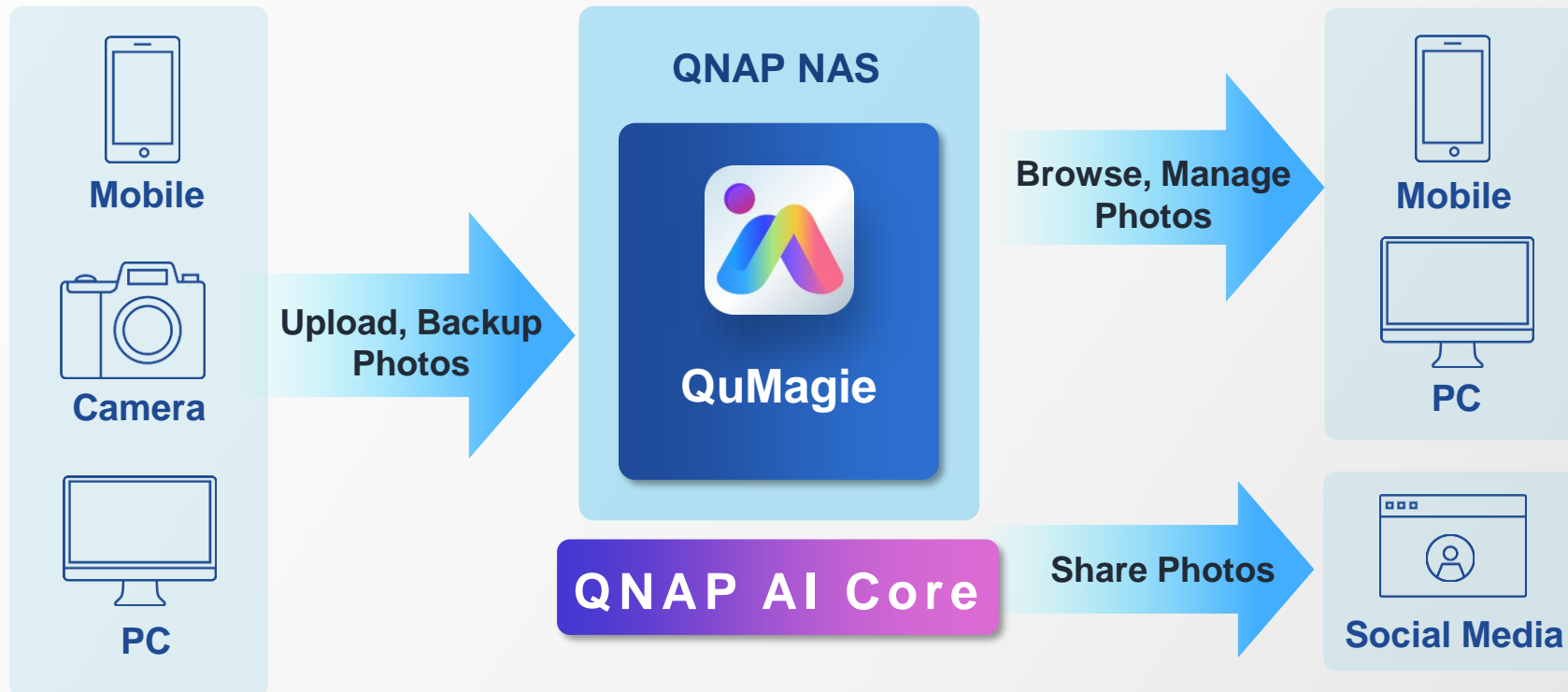

# DA Drive Analyzer , Predict Drive Failure and Minimize Downtime



1 free disk prediction per NAS

Paid subscription for additional disks for added protection

The screenshot shows the DA Drive Analyzer interface. The top navigation bar includes 'Overview', 'Drive Prediction', 'Email Alerts', 'Additional Information', and 'Prediction History'. The main content area is titled 'Overview' and displays a summary of drive health: 5 Faulty, 4 Critical, 9 Warning, and 1 Normal. Below this, an 'Important: Review Drive Status' section provides a table of drive details.

| Drive (Drive Enclosure) | Severity Level | Drive Manufacturer | Drive Capacity |
|-------------------------|----------------|--------------------|----------------|
| Disk 1 (NAS Host)       | Warning        | ST320LM001         | 298.09 GB      |
| Disk 2 (NAS Host)       | Warning        | WDC                | 298.09 GB      |
| Disk 4 (NAS Host)       | Faulty         | ST320LM001         | 298.09 GB      |
| Disk 7 (NAS Host)       | Warning        | TOSHIBA            | 298.09 GB      |
| Disk 8 (NAS Host)       | Critical       | WDC                | 298.09 GB      |
| Disk 9 (NAS Host)       | Faulty         | TOSHIBA            | 298.09 GB      |

## Predict Drive Failure and Minimize Downtime

DA Drive Analyzer integrates ULINK cloud artificial intelligence technology, which can notify you before disk failure, helping you prevent data loss or downtime loss caused by unwarranted disk damage.



# Backup data with deduplication

## Hybrid Backup Sync

Keep 3 copies, on 2 types of storage, and store 1 copy off-site to ensure your data safety.

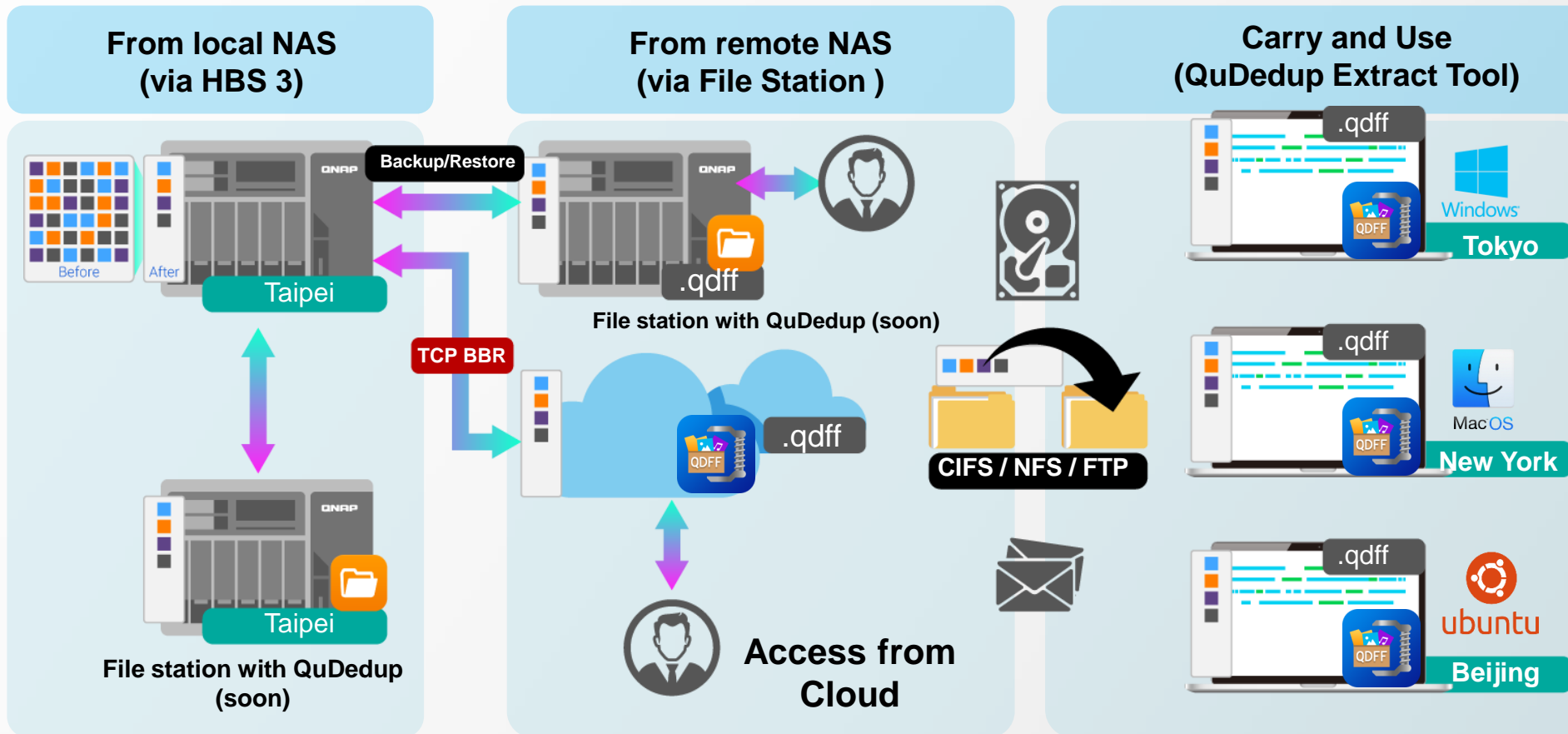

# Snapshots Help You Fight with Ransomware Threats

TS-253E / TS-453E supports Snapshot , like taking a photo - within seconds the complete status of your NAS system and data is recorded.

## Mitigate the growing threat of ransomware

### Step 1

Regularly update, and use Malware Remover

### Step 2

Routinely back up to your NAS, and create multi-version snapshots

### Step 3

Back up snapshots to another QNAP NAS

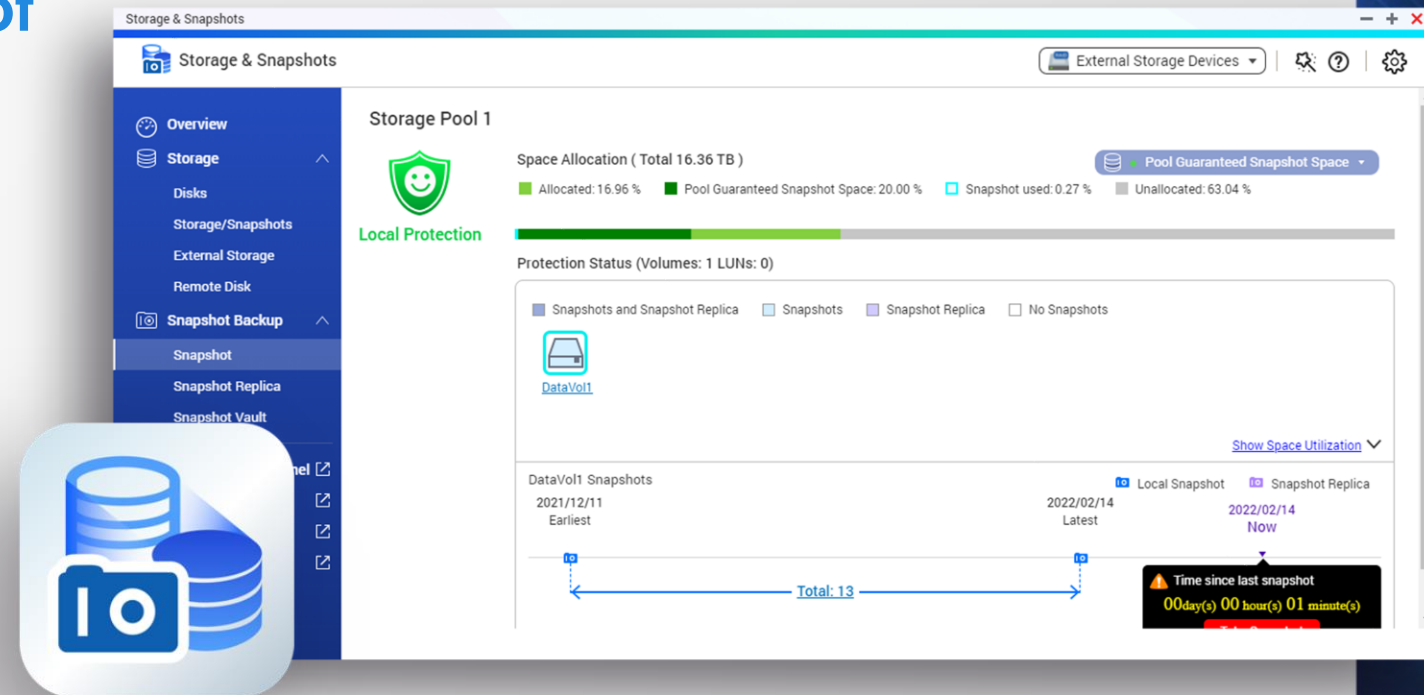

# Virtualization Station



## Virtualization Station

With Virtualization Station, you can create multiple virtual machines to run various operating systems such as Windows, Linux, UNIX and Android on TS-253E / TS-453E.

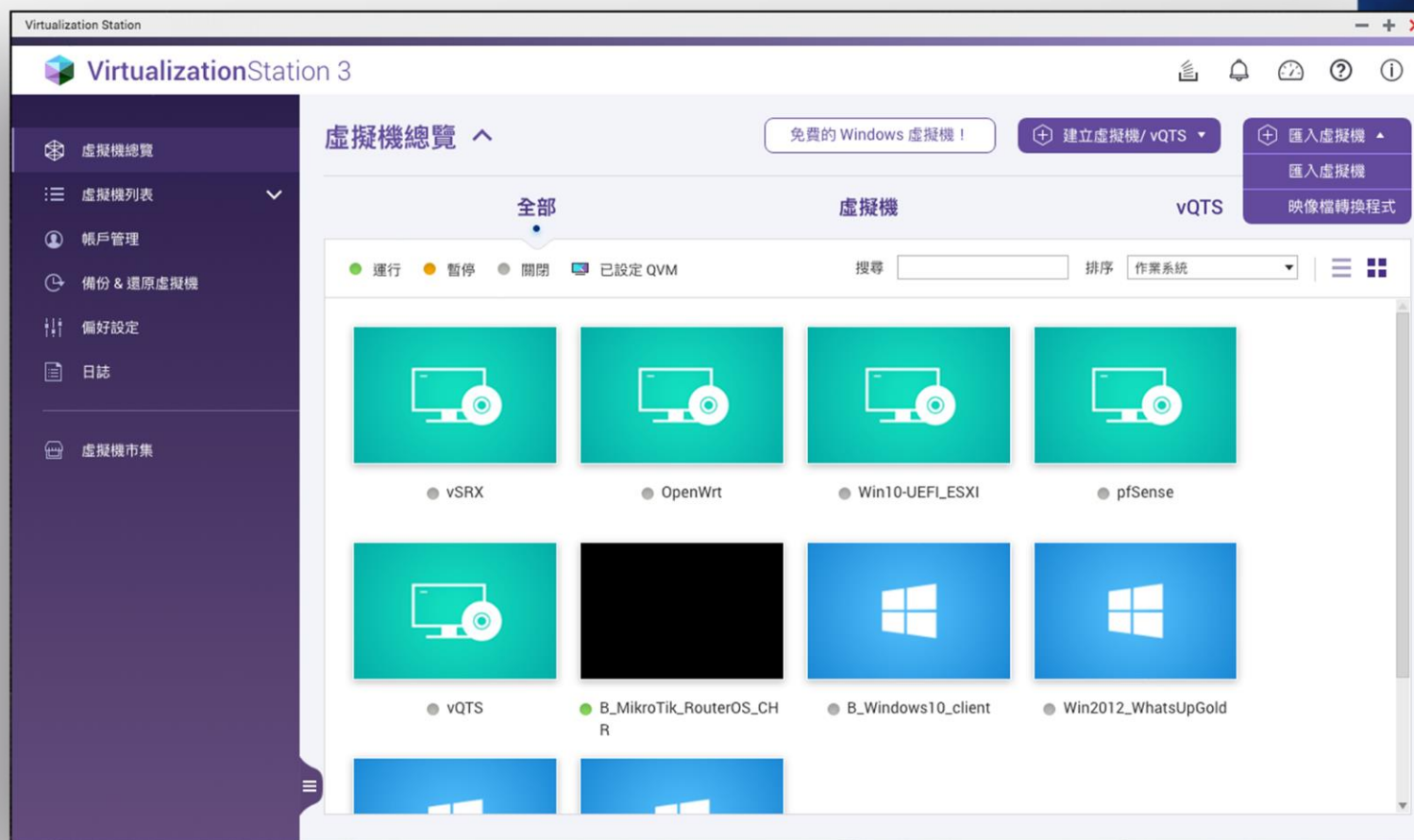

# Container Station



## Container Station

Exclusively integrates LXD and Docker®, Kata lightweight virtualization technologies, allowing you to operate multiple isolated Linux® systems on a QNAP NAS as well as download apps from the built-in Docker® Hub/LXD Image Server Registry.

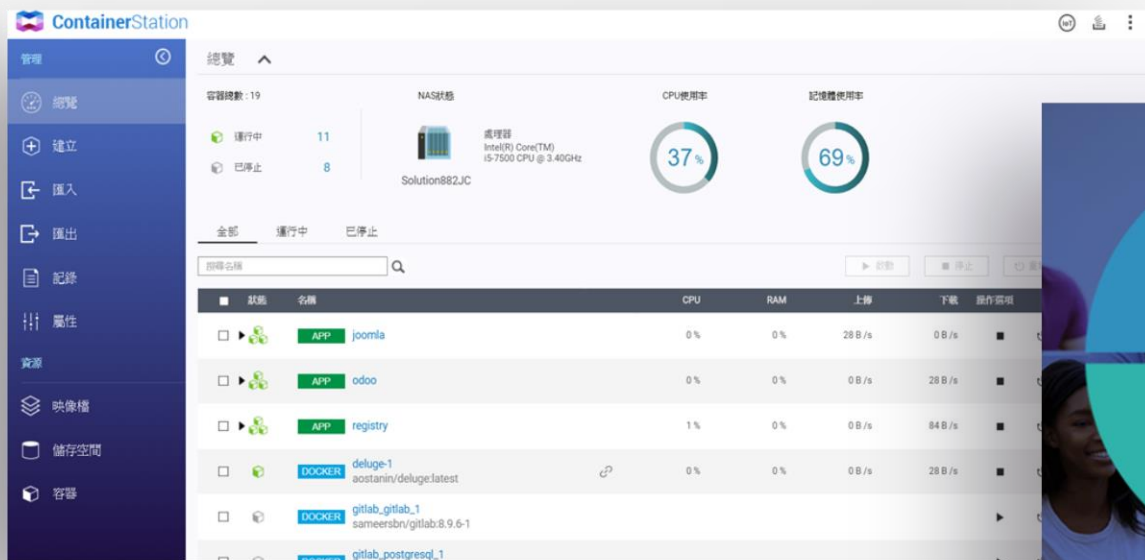



# Qsync , Cross-device file sync for individuals and teams

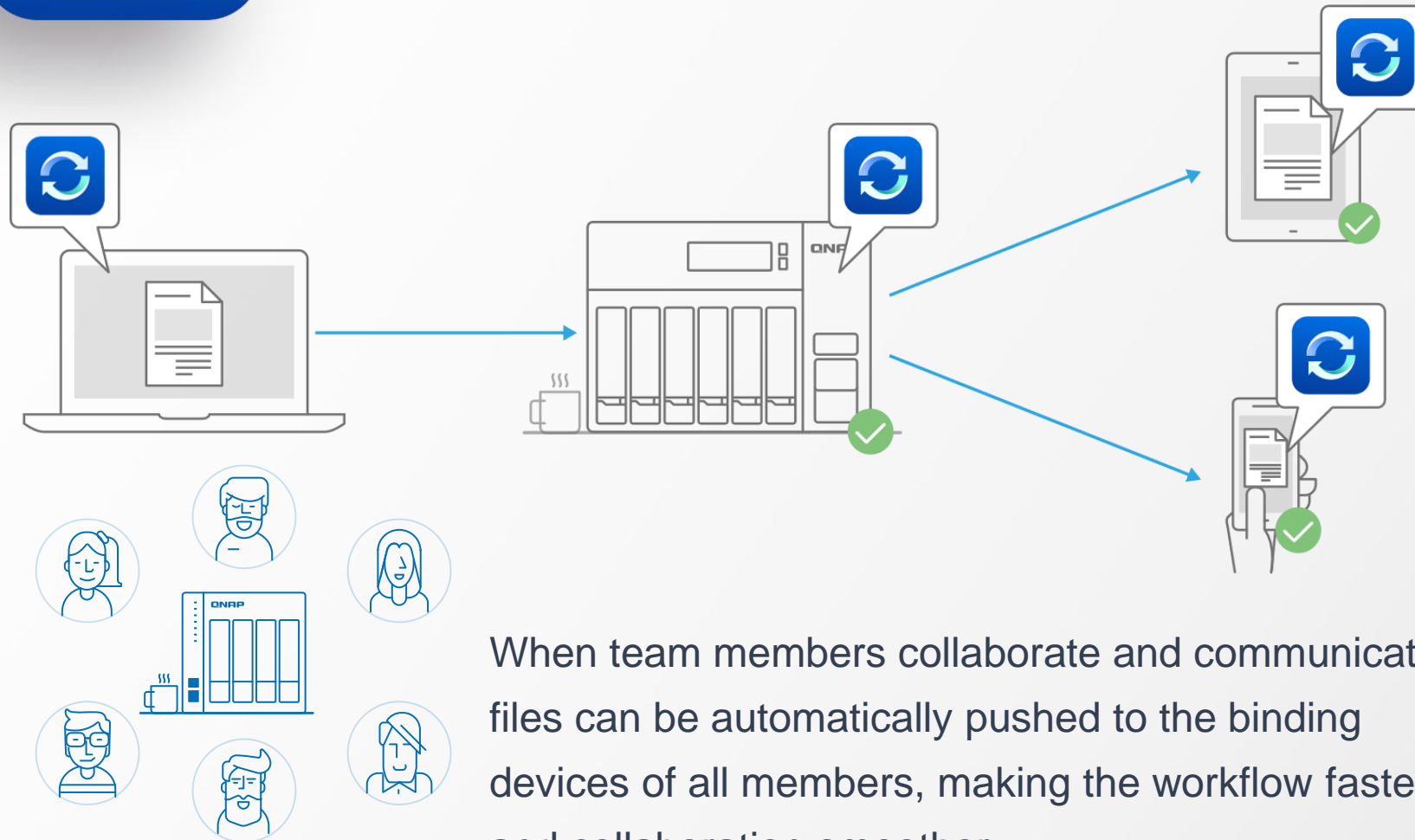

When there are different devices such as laptops and mobile phones, as long as the files are modified on a single device, the modified files will be automatically synchronized to other devices.

When team members collaborate and communicate, files can be automatically pushed to the binding devices of all members, making the workflow faster and collaboration smoother.

# QNAP meets all needs for an office



# TS-253E / TS-453E support Dual HDMI 4K output



## Dual HDMI 4K output

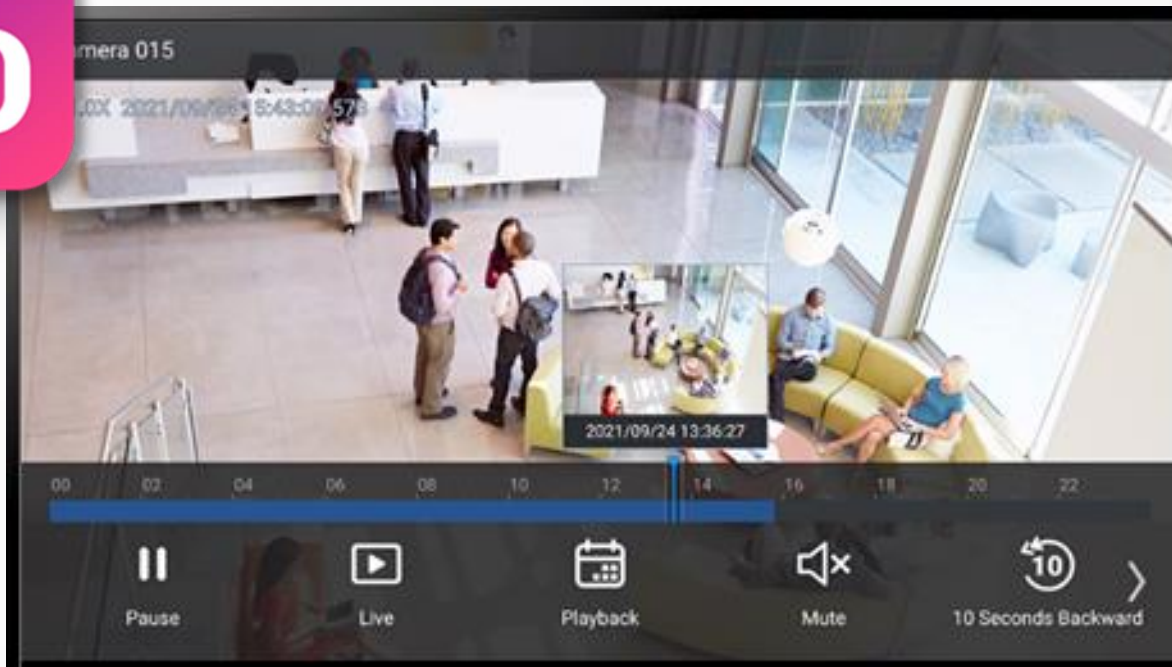

Directly connect the dual-screen output, you can extend and mirror the screen, use it as a large-screen monitor, or install the HybridDesk Station to turn it into a theater.

# HybridDesk Station for various A/V needs





# QVR Elite Smart Surveillance System

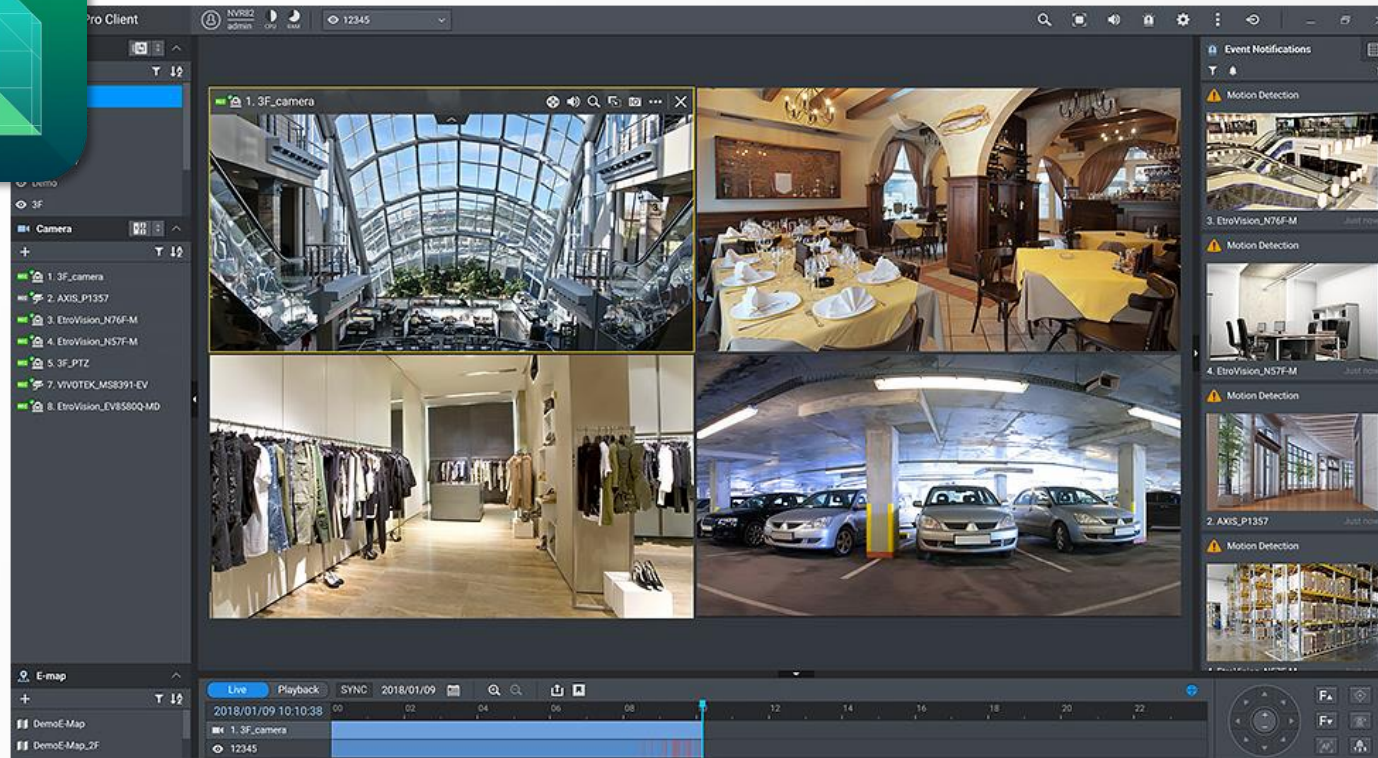

2 channels are included for free  
(expandable)

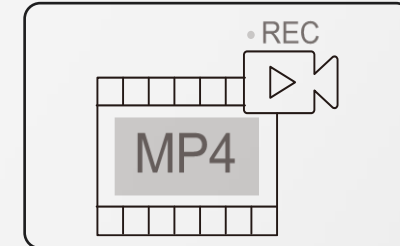

Record using the MP4 Format

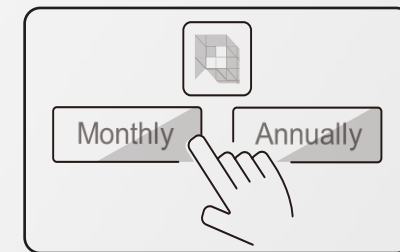

Flexible Subscription

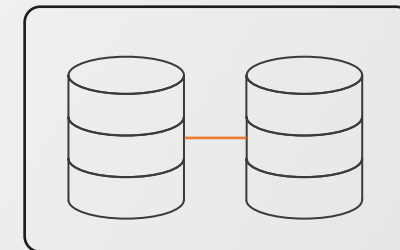

Expandable Capacity

# QVR Elite with powerful IP surveillance camera management and support

More than **180** brands



**Panasonic**



**MOBOTIX**

**Canon**

**HIKVISION**

**a|hua**  
TECHNOLOGY

**Honeywell**

**Brickcom**

More than **6700** models



**ONVIF Profile** support



Record into QVR Elite by using the RTSP/RTMP link with no integration needed. Multiple video sources are supported - not just IP cameras.

# The monitor screen can be upgraded to a video wall through dual HDMI screen output

Assign IP CAM in video wall mode in different screen



We can move the QVR monitoring output to another screen and operate other APPs on the original screen



# Through Mirror output, the same picture can also be output to different screens

With Mirror output, the same picture can be output to monitors in different places for monitoring



# Built-in Firewall for QNAP Appliances

## QuFirewall

You can allow/deny IP addresses and regions to prevent unauthorized access and brute force attacks for safeguarding data and service security.

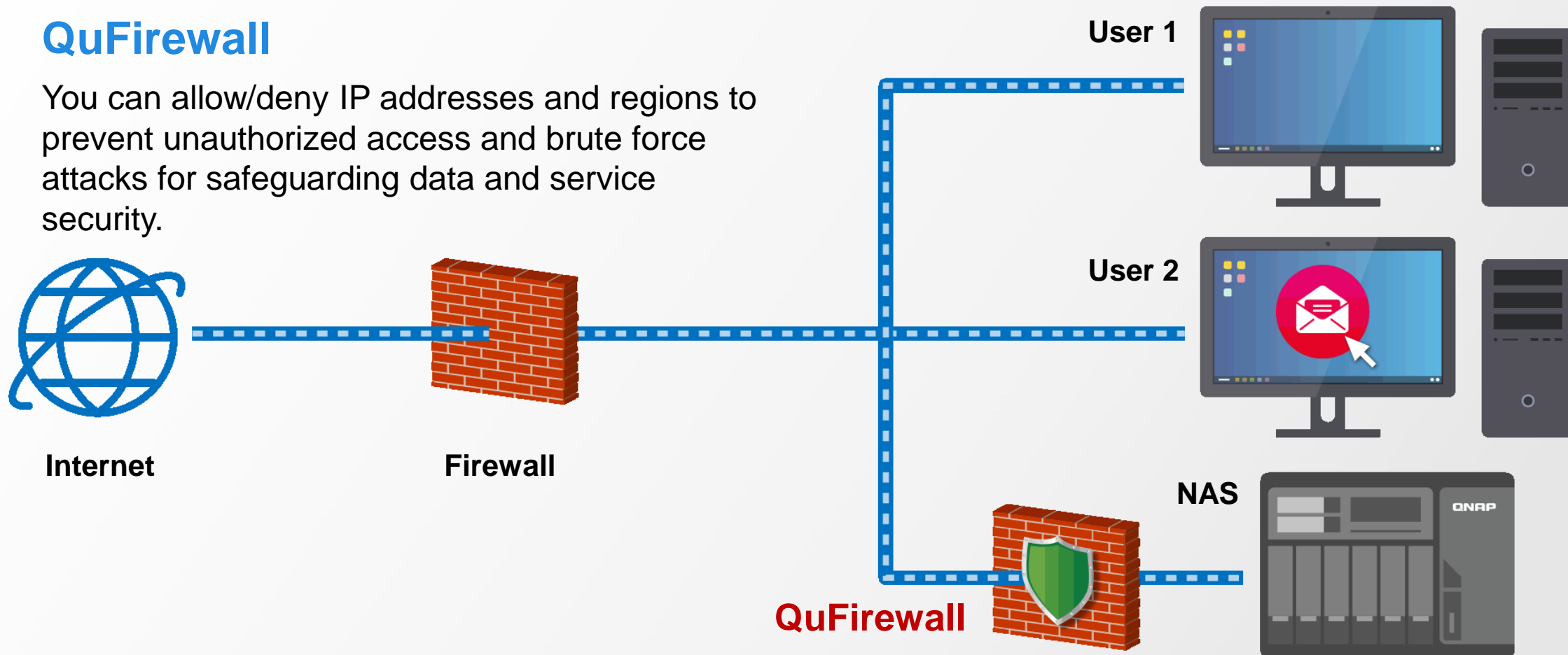

# Secure communication for peace of mind



## QVPN

- In addition to establishing a VPN client connection to a remote server, QVPN can also be used as a VPN server.
- Supports WireGuard® to provide faster and more stable VPN connections, and to easily set up VPN

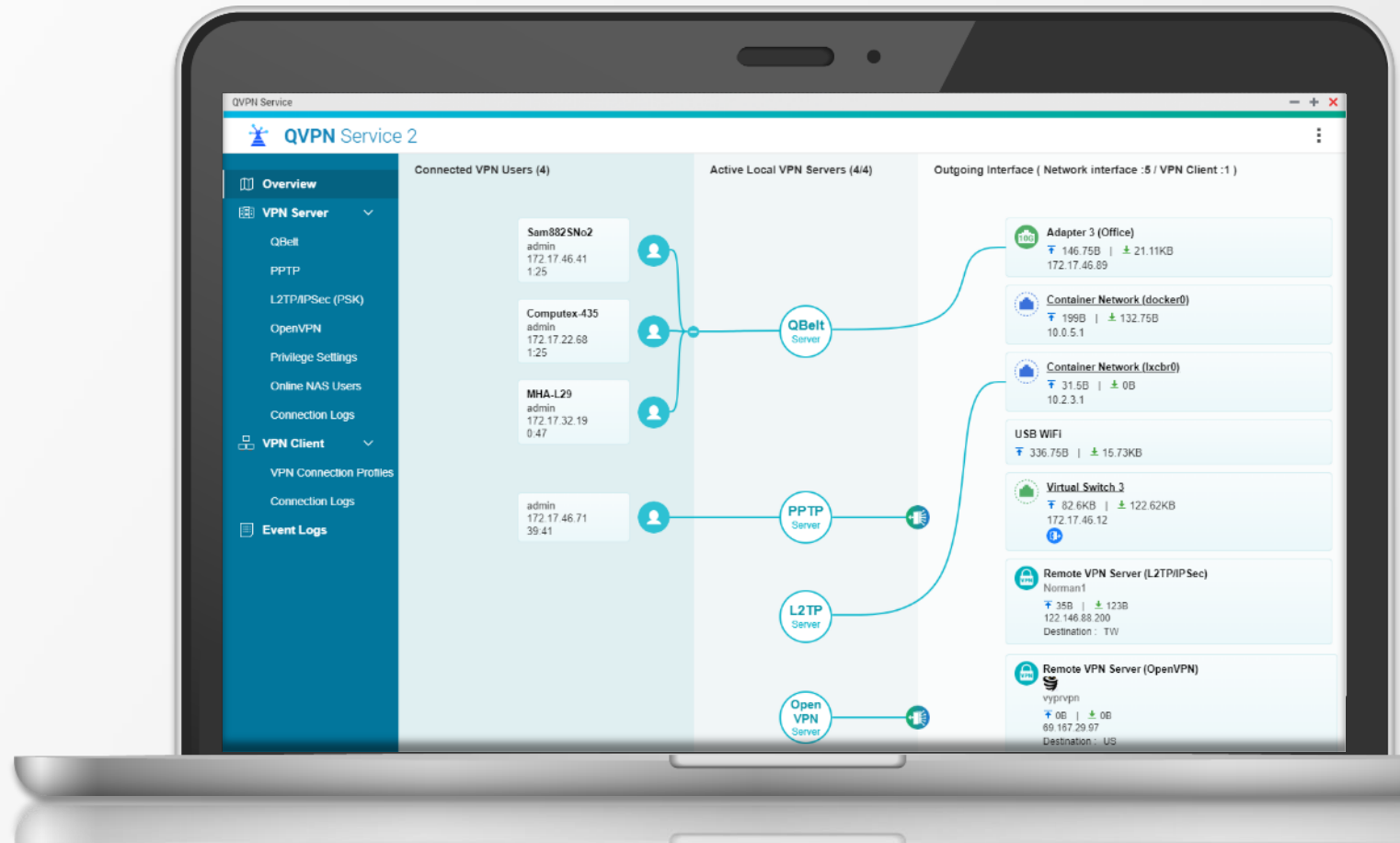



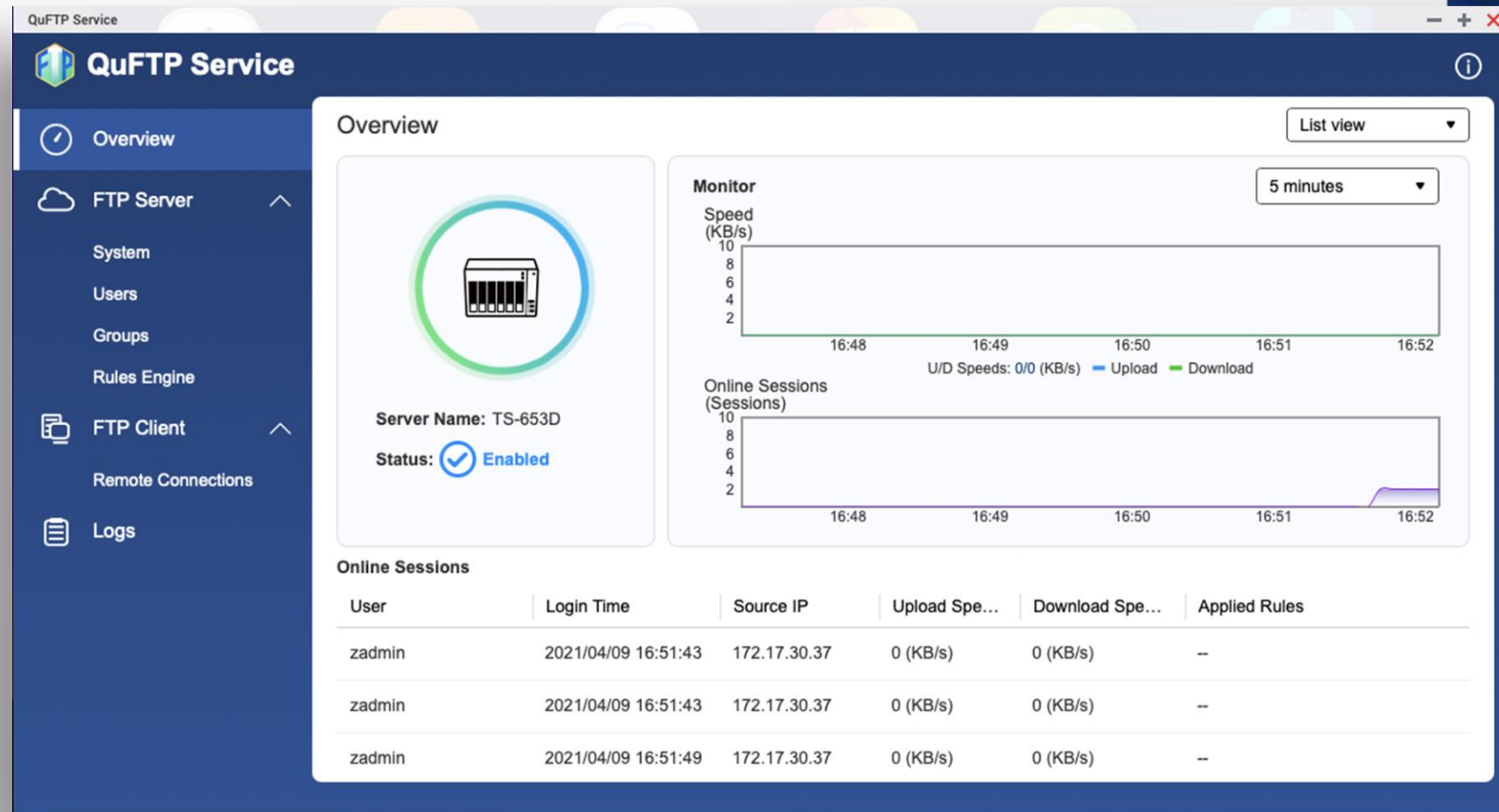

# QuFTP remote file FTP access service

- Updated independent
- Support FTP server
- Support FTP client
- Support TLS setting
- Support QoS setting



# TS-253E / TS-453E with greatly improved performance

|        | TS-251+   |  TS-253E   | TS-451+  |  TS-453E  |
|--------|---|--|--|--|
| SKU    | TS-251+-2G<br>TS-251+-8G  |  TS-253E-8G  | TS-451+-2G<br>TS-451+-8G   |  TS-453E-8G   |
| CPU    | Intel® Celeron® J1900 4-core/4-thread processor, burst up to 2.42 GHz   | Intel® Celeron® J6412 4-core/4-thread processor, <b>burst up to 2.6 GHz</b>  | Intel® Celeron® J1900 4-core/4-thread processor, burst up to 2.42 GHz  | Intel® Celeron® J6412 4-core/4-thread processor, <b>burst up to 2.6 GHz</b>  |
| O.S.   | QTS   | QTS  | QTS  | QTS  |
| Memory | Max 8 GB DDR3L (2 x 4 GB)   | <b>8 GB DDR4 onboard</b> not expandable  | Max 8 GB DDR3L (2 x 4 GB)  | <b>8 GB DDR4 onboard</b> not expandable  |
| LAN    | Gigabit Ethernet Port (RJ45) x 2  | <b>2 x 2.5 Gigabit</b> Ethernet Port (2.5G/1G/100M)  | Gigabit Ethernet Port (RJ45) x 2   | <b>2 x 2.5 Gigabit</b> Ethernet Port (2.5G/1G/100M)  |
| M.2    | -   | <b>2 x M.2 2280 PCIe Gen 3 x2</b>  | -  | <b>2 x M.2 2280 PCIe Gen 3 x2</b>  |
| I/O    | <ul style="list-style-type: none"> <li>• USB 2.0 x 2</li> <li>• 2 x USB 3.2 Gen 1</li> <li>• HDMI x 1(Max 1080p)</li> </ul> | <ul style="list-style-type: none"> <li>• USB 2.0 x 2</li> <li>• 2 x USB 3.2 Gen 2</li> <li>• <b>HDMI x 2 (up to 3840 x 2160 @ 30Hz)</b></li> </ul> | <ul style="list-style-type: none"> <li>• USB 2.0 x 2</li> <li>• 2 x USB 3.2 Gen 1</li> <li>• HDMI x 1 (Max 1080p)</li> </ul> | <ul style="list-style-type: none"> <li>• USB 2.0 x 2</li> <li>• 2 x USB 3.2 Gen 2</li> <li>• <b>HDMI x 2 (up to 3840 x 2160 @ 30Hz)</b></li> </ul> |



# Shipped with 3 - year standard warranty, optional up to 5 - year coverage



## TS-253E / TS-453E

Backed by a 3-year warranty at no additional cost.

### Extend hardware warranty up to 5 years

You can also purchase a warranty extension that extends your warranty coverage up to 5 years. ( LW-NAS-PEACH-2Y )

Learn More: [QNAP warranty services](#)

TS-253E



TS-453E



# TS-253E / TS-453E

Intel® J6412 Quad-Core Long-Term Availability NAS for Business and Professional Users

Provides dual-port 2.5 GbE, 4K HDMI dual-screen output, and dual M.2 PCIe SSD expansion slots

**QNAP**

Copyright © 2022 QNAP Systems, Inc. All rights reserved. QNAP® and other names of QNAP Products are proprietary marks or registered trademarks of QNAP Systems, Inc. Other products and company names mentioned herein are trademarks of their respective holders.



TS-253E

TS-453E