

Latitude 3420

Service Manual for computers with integrated graphics

Notes, cautions, and warnings

 **NOTE:** A NOTE indicates important information that helps you make better use of your product.

 **CAUTION:** A CAUTION indicates either potential damage to hardware or loss of data and tells you how to avoid the problem.

 **WARNING:** A WARNING indicates a potential for property damage, personal injury, or death.

Chapter 1: Working inside your computer	7
Safety instructions.....	7
Before working inside your computer.....	7
Entering Service Mode.....	8
Exiting Service Mode.....	8
Safety precautions.....	8
Electrostatic discharge—ESD protection.....	9
ESD field service kit	9
Transporting sensitive components.....	10
After working inside your computer.....	10
Chapter 2: Removing and installing components	11
Recommended tools.....	11
Screw List.....	11
Major components of your system.....	13
MicroSD-card.....	14
Removing the microSD-card.....	14
Installing the MicroSD-card.....	15
SIM card tray.....	15
Removing the SIM card tray.....	15
Installing the SIM card tray.....	16
Base cover.....	17
Removing the base cover.....	17
Installing the base cover.....	19
Memory module.....	20
Removing the memory module.....	20
Installing the memory module.....	21
M.2 solid-state drive.....	23
Removing the M.2 2230 solid-state drive.....	23
Installing the M.2 2230 solid-state drive.....	23
Removing the M.2 2280 solid-state drive.....	24
Installing the M.2 2280 solid-state drive.....	25
Battery cable.....	26
Removing the battery cable.....	26
Installing the battery cable.....	27
M.2 solid-state drive conversion bracket.....	27
Replacing the M.2 solid-state drive conversion bracket.....	27
M.2 solid-state drive conversion plate.....	28
Removing the M.2 solid-state drive conversion plate.....	28
Installing the M.2 solid-state drive conversion plate.....	29
Hard-disk drive assembly.....	30
Removing the hard-disk drive assembly.....	30
Removing the hard-disk drive bracket	31
Installing the hard-disk drive bracket.....	33

Installing the hard-disk drive assembly.....	34
WLAN card.....	35
Removing the WLAN card.....	35
Installing the WLAN card.....	36
WWAN card.....	38
Removing the WWAN card.....	38
Installing the WWAN card.....	39
System fan.....	40
Removing the system fan.....	40
Installing the system fan.....	41
Battery.....	42
Rechargeable Li-ion battery precautions.....	42
Removing the 3-cell battery.....	43
Installing the 3-cell battery.....	44
Removing the 4-cell battery.....	46
Installing the 4-cell battery.....	47
I/O cable.....	48
Removing the I/O cable.....	48
Installing the I/O cable.....	49
Display assembly.....	49
Removing the display assembly.....	49
Installing the display assembly.....	52
Display panel.....	54
Removing the display panel.....	54
Installing the display panel.....	57
Display bezel.....	60
Removing the display bezel.....	60
Installing the display bezel.....	61
Heatsink assembly.....	62
Removing the heatsink assembly.....	62
Installing the heatsink assembly.....	62
Power adapter port.....	63
Removing the power adapter port.....	63
Installing the power adapter port.....	64
Coin-cell battery.....	65
Removing the coin-cell battery.....	65
Installing the coin-cell battery.....	66
USB cable.....	67
Removing the USB cable.....	67
Installing the USB cable.....	68
Ethernet port.....	69
Removing the ethernet port.....	69
Installing the ethernet port.....	70
I/O board.....	71
Removing the I/O board.....	71
Installing the I/O board.....	72
Power button.....	73
Removing the power button without fingerprint reader.....	73
Installing the power button without fingerprint reader.....	74
Removing the power button with fingerprint reader.....	75

Installing the power button with fingerprint reader.....	76
System board.....	77
Removing the system board.....	77
Installing the system board.....	79
Speakers.....	83
Removing the speaker.....	83
Installing the speaker.....	84
Touchpad	85
Removing the touchpad.....	85
Installing the touchpad.....	86
WWAN I/O board	87
Removing the WWAN I/O board.....	87
Installing the WWAN I/O board.....	87
Palmrest assembly.....	88
Removing the palmrest assembly.....	88
Installing the palmrest assembly.....	89
Camera.....	91
Removing the camera	91
Installing the camera	91
Display cable.....	92
Removing the display cable	92
Installing the display cable	93
Display back-cover.....	95
Removing the display back-cover.....	95
Installing the display back-cover.....	95
Chapter 3: Drivers and downloads.....	97
Chapter 4: BIOS setup.....	98
BIOS overview.....	98
Entering BIOS setup program.....	98
Navigation keys.....	98
One time boot menu.....	99
System setup options.....	99
Updating the BIOS.....	109
Updating the BIOS in Windows.....	109
Updating the BIOS in Linux and Ubuntu.....	109
Updating the BIOS using the USB drive in Windows.....	109
Updating the BIOS from the F12 One-Time boot menu.....	110
System and setup password.....	111
Assigning a system setup password.....	111
Deleting or changing an existing system setup password.....	111
Clearing CMOS settings.....	112
Clearing BIOS (System Setup) and System passwords.....	112
Chapter 5: Troubleshooting.....	113
Handling swollen rechargeable Li-ion batteries.....	113
Dell SupportAssist Pre-boot System Performance Check diagnostics.....	113
Running the SupportAssist Pre-Boot System Performance Check.....	114











Built-in self-test (BIST).....	114
M-BIST.....	114
LCD Power rail test (L-BIST).....	115
LCD Built-in Self Test (BIST).....	115
System-diagnostic lights.....	115
Recovering the operating system.....	117
Real-Time Clock (RTC Reset).....	117
Backup media and recovery options.....	117
WiFi power cycle.....	118
Drain residual flea power (perform hard reset).....	118

Chapter 6: Getting help and contacting Dell..... 119

Working inside your computer

Safety instructions

Use the following safety guidelines to protect your computer from potential damage and to ensure your personal safety. Unless otherwise noted, each procedure included in this document assumes that you have read the safety information that shipped with your computer.

-  **WARNING:** Before working inside your computer, read the safety information that is shipped with your computer. For more safety best practices, see the Regulatory Compliance home page at www.dell.com/regulatory_compliance.
-  **WARNING:** Disconnect your computer from all power sources before opening the computer cover or panels. After you finish working inside the computer, replace all covers, panels, and screws before connecting your computer to an electrical outlet.
-  **CAUTION:** To avoid damaging the computer, ensure that the work surface is flat, dry, and clean.
-  **CAUTION:** To avoid damaging the components and cards, handle them by their edges, and avoid touching the pins and the contacts.
-  **CAUTION:** You should only perform troubleshooting and repairs as authorized or directed by the Dell technical assistance team. Damage due to servicing that is not authorized by Dell is not covered by your warranty. See the safety instructions that is shipped with the product or at www.dell.com/regulatory_compliance.
-  **CAUTION:** Before touching anything inside your computer, ground yourself by touching an unpainted metal surface, such as the metal at the back of the computer. While you work, periodically touch an unpainted metal surface to dissipate static electricity which could harm internal components.
-  **CAUTION:** When you disconnect a cable, pull it by its connector or its pull tab, not the cable itself. Some cables have connectors with locking tabs or thumbscrews that you must disengage before disconnecting the cable. When disconnecting cables, keep them evenly aligned to avoid bending the connector pins. When connecting cables, ensure that the ports and the connectors are correctly oriented and aligned.
-  **CAUTION:** Press and eject any installed card from the media-card reader.
-  **CAUTION:** Exercise caution when handling rechargeable Li-ion batteries in laptops. Swollen batteries should not be used and should be replaced and disposed properly.
-  **NOTE:** The color of your computer and certain components may appear differently than shown in this document.

Before working inside your computer

About this task

-  **NOTE:** The images in this document may differ from your computer depending on the configuration you ordered.

Steps

1. Save and close all open files and exit all open applications.
2. Shut down your computer. For Windows operating system, click **Start** >  **Power** > **Shut down**.

 **NOTE:** If you are using a different operating system, see the documentation of your operating system for shut-down instructions.

3. Disconnect your computer and all attached devices from their electrical outlets.
4. Disconnect all attached network devices and peripherals, such as keyboard, mouse, and monitor from your computer.

 **CAUTION:** To disconnect a network cable, first unplug the cable from your computer and then unplug the cable from the network device.

5. Remove any media card and optical disc from your computer, if applicable.

Entering Service Mode

Service Mode allows users to immediately cut off electricity from the computer and conduct repairs without disconnecting the battery cable from the system board.

To enter **Service Mode**:

1. Shut down your computer and disconnect the AC adapter.
2. Hold **** key on the keyboard and press the power button for 3 seconds or until the Dell logo appears on the screen.
3. Press any key to continue.

 **NOTE:** If the power adapter has not been disconnected, a message prompting you to remove the AC adapter appears on the screen. Remove the AC adapter and then press any key to continue the **Service Mode** procedure.

 **NOTE:** The **Service Mode** procedure automatically skips the following step if the **Owner Tag** of the computer is not set up in advance by the manufacturer.

4. When the ready-to-proceed message appears on the screen, press any key to proceed. The computer emits three short beeps and shuts down immediately.

Once the computer shuts down, you may perform the replacement procedures without disconnecting the battery cable from the system board.

Exiting Service Mode

Service Mode allows users to immediately cut off electricity from the computer and conduct repairs without disconnecting the battery cable from the system board.

To exit **Service Mode**:

1. Connect the AC adapter to the power-adapter port on your computer.
2. Press the power button to turn on the computer. Your computer will automatically return to normal functioning mode.

Safety precautions

The safety precautions chapter details the primary steps to be taken before performing any disassembly instructions.

Observe the following safety precautions before you perform any installation or break/fix procedures involving disassembly or reassembly:

- Turn off the system and all attached peripherals.
- Disconnect the system and all attached peripherals from AC power.
- Disconnect all network cables, telephone, and telecommunications lines from the system.
- Use an ESD field service kit when working inside any to avoid electrostatic discharge (ESD) damage.
- After removing any system component, carefully place the removed component on an anti-static mat.
- Wear shoes with non-conductive rubber soles to reduce the chance of getting electrocuted.

Standby power

Dell products with standby power must be unplugged before you open the case. Systems that incorporate standby power are essentially powered while turned off. The internal power enables the system to be remotely turned on (wake on LAN) and suspended into a sleep mode and has other advanced power management features.

Unplugging, pressing, and holding the power button for 15 seconds should discharge residual power in the system board.

Bonding

Bonding is a method for connecting two or more grounding conductors to the same electrical potential. This is done through the use of a field service electrostatic discharge (ESD) kit. When connecting a bonding wire, ensure that it is connected to bare metal and never to a painted or non-metal surface. The wrist strap should be secure and in full contact with your skin, and ensure that you remove all jewelry such as watches, bracelets, or rings prior to bonding yourself and the equipment.

Electrostatic discharge—ESD protection

ESD is a major concern when you handle electronic components, especially sensitive components such as expansion cards, processors, memory DIMMs, and system boards. Very slight charges can damage circuits in ways that may not be obvious, such as intermittent problems or a shortened product life span. As the industry pushes for lower power requirements and increased density, ESD protection is an increasing concern.

Due to the increased density of semiconductors used in recent Dell products, the sensitivity to static damage is now higher than in previous Dell products. For this reason, some previously approved methods of handling parts are no longer applicable.

Two recognized types of ESD damage are catastrophic and intermittent failures.

- **Catastrophic** – Catastrophic failures represent approximately 20 percent of ESD-related failures. The damage causes an immediate and complete loss of device functionality. An example of catastrophic failure is a memory DIMM that has received a static shock and immediately generates a "No POST/No Video" symptom with a beep code emitted for missing or nonfunctional memory.
- **Intermittent** – Intermittent failures represent approximately 80 percent of ESD-related failures. The high rate of intermittent failures means that most of the time when damage occurs, it is not immediately recognizable. The DIMM receives a static shock, but the tracing is merely weakened and does not immediately produce outward symptoms related to the damage. The weakened trace may take weeks or months to melt, and in the meantime may cause degradation of memory integrity, intermittent memory errors, etc.

Perform the following steps to prevent ESD damage:

- Use a wired ESD wrist strap that is properly grounded. The use of wireless anti-static straps is no longer allowed; they do not provide adequate protection. Touching the chassis before handling parts does not ensure adequate ESD protection on parts with increased sensitivity to ESD damage.
- Handle all static-sensitive components in a static-safe area. If possible, use anti-static floor pads and workbench pads.
- When unpacking a static-sensitive component from its shipping carton, do not remove the component from the anti-static packing material until you are ready to install the component. Before unwrapping the anti-static packaging, ensure that you discharge static electricity from your body.
- Before transporting a static-sensitive component, place it in an anti-static container or packaging.

ESD field service kit

The unmonitored Field Service kit is the most commonly used service kit. Each Field Service kit includes three main components: anti-static mat, wrist strap, and bonding wire.

Components of an ESD field service kit

The components of an ESD field service kit are:

- **Anti-Static Mat** – The anti-static mat is dissipative and parts can be placed on it during service procedures. When using an anti-static mat, your wrist strap should be snug and the bonding wire should be connected to the mat and to any bare metal on the system being worked on. Once deployed properly, service parts can be removed from the ESD bag and placed directly on the mat. ESD-sensitive items are safe in your hand, on the ESD mat, in the system, or inside a bag.
- **Wrist Strap and Bonding Wire** – The wrist strap and bonding wire can be either directly connected between your wrist and bare metal on the hardware if the ESD mat is not required, or connected to the anti-static mat to protect hardware that

is temporarily placed on the mat. The physical connection of the wrist strap and bonding wire between your skin, the ESD mat, and the hardware is known as bonding. Use only Field Service kits with a wrist strap, mat, and bonding wire. Never use wireless wrist straps. Always be aware that the internal wires of a wrist strap are prone to damage from normal wear and tear, and must be checked regularly with a wrist strap tester in order to avoid accidental ESD hardware damage. It is recommended to test the wrist strap and bonding wire at least once per week.

- **ESD Wrist Strap Tester** – The wires inside of an ESD strap are prone to damage over time. When using an unmonitored kit, it is a best practice to regularly test the strap prior to each service call, and at a minimum, test once per week. A wrist strap tester is the best method for doing this test. If you do not have your own wrist strap tester, check with your regional office to find out if they have one. To perform the test, plug the wrist-strap's bonding-wire into the tester while it is strapped to your wrist and push the button to test. A green LED is lit if the test is successful; a red LED is lit and an alarm sounds if the test fails.
- **Insulator Elements** – It is critical to keep ESD sensitive devices, such as plastic heat sink casings, away from internal parts that are insulators and often highly charged.
- **Working Environment** – Before deploying the ESD Field Service kit, assess the situation at the customer location. For example, deploying the kit for a server environment is different than for a desktop or portable environment. Servers are typically installed in a rack within a data center; desktops or portables are typically placed on office desks or cubicles. Always look for a large open flat work area that is free of clutter and large enough to deploy the ESD kit with additional space to accommodate the type of system that is being repaired. The workspace should also be free of insulators that can cause an ESD event. On the work area, insulators such as Styrofoam and other plastics should always be moved at least 12 inches or 30 centimeters away from sensitive parts before physically handling any hardware components
- **ESD Packaging** – All ESD-sensitive devices must be shipped and received in static-safe packaging. Metal, static-shielded bags are preferred. However, you should always return the damaged part using the same ESD bag and packaging that the new part arrived in. The ESD bag should be folded over and taped shut and all the same foam packing material should be used in the original box that the new part arrived in. ESD-sensitive devices should be removed from packaging only at an ESD-protected work surface, and parts should never be placed on top of the ESD bag because only the inside of the bag is shielded. Always place parts in your hand, on the ESD mat, in the system, or inside an anti-static bag.
- **Transporting Sensitive Components** – When transporting ESD sensitive components such as replacement parts or parts to be returned to Dell, it is critical to place these parts in anti-static bags for safe transport.

ESD protection summary

It is recommended that all field service technicians use the traditional wired ESD grounding wrist strap and protective anti-static mat at all times when servicing Dell products. In addition, it is critical that technicians keep sensitive parts separate from all insulator parts while performing service and that they use anti-static bags for transporting sensitive components.

Transporting sensitive components

When transporting ESD sensitive components such as replacement parts or parts to be returned to Dell, it is critical to place these parts in anti-static bags for safe transport.

After working inside your computer

About this task

 **NOTE:** Leaving stray or loose screws inside your computer may severely damage your computer.

Steps

1. Replace all screws and ensure that no stray screws remain inside your computer.
2. Connect any external devices, peripherals, or cables you removed before working on your computer.
3. Replace any media cards, discs, or any other parts that you removed before working on your computer.
4. Connect your computer and all attached devices to their electrical outlets.
5. Turn on your computer.

Removing and installing components

NOTE: The images in this document may differ from your computer depending on the configuration you ordered.

Recommended tools

The procedures in this document may require the following tools:

- Phillips #0 screwdriver
- Plastic scribe

Screw List

The following table shows the screw list and the image of the screws.

Table 1. Screw list





















Component	Screw type	Quantity	Image
Base cover	Captive screws	8	
M.2 Solid-state drive bracket	M2x3	1	
M.2 Solid-state drive conversion bracket	M2x3	1	
M.2 Solid-state drive conversion plate	M2x3	2	
Hard disk-drive module	M2X4.5	3	
Hard disk-drive	M3x3	4	
WLAN card	M2x3	1	
WWAN card	M2x3	1	
System Fan	M2x3	2	
3-cell battery	M2x3	3	
4-cell battery	M2x3	4	

Table 1. Screw list (continued)

Component	Screw type	Quantity	Image
Display hinges	M2.5x6	3	
	M2.5x4	2	
Hinge bracket	M2.5x2.5	6	
	M2.5x3	2	
Heatsink assembly	Captive screws	7 (For systems enabled with discrete graphic card) 4 (For systems enabled with integrated graphic card)	
Power adapter port	M2x3	1	
Ethernet port	M2x5	1	
I/O board	M2x3	2	
System board	M2x2	2	
Touchpad bracket	M2x2.5	3	
Touchpad module	M2x2	4	
WWAN I/O board	M2x3	2	

Major components of your system

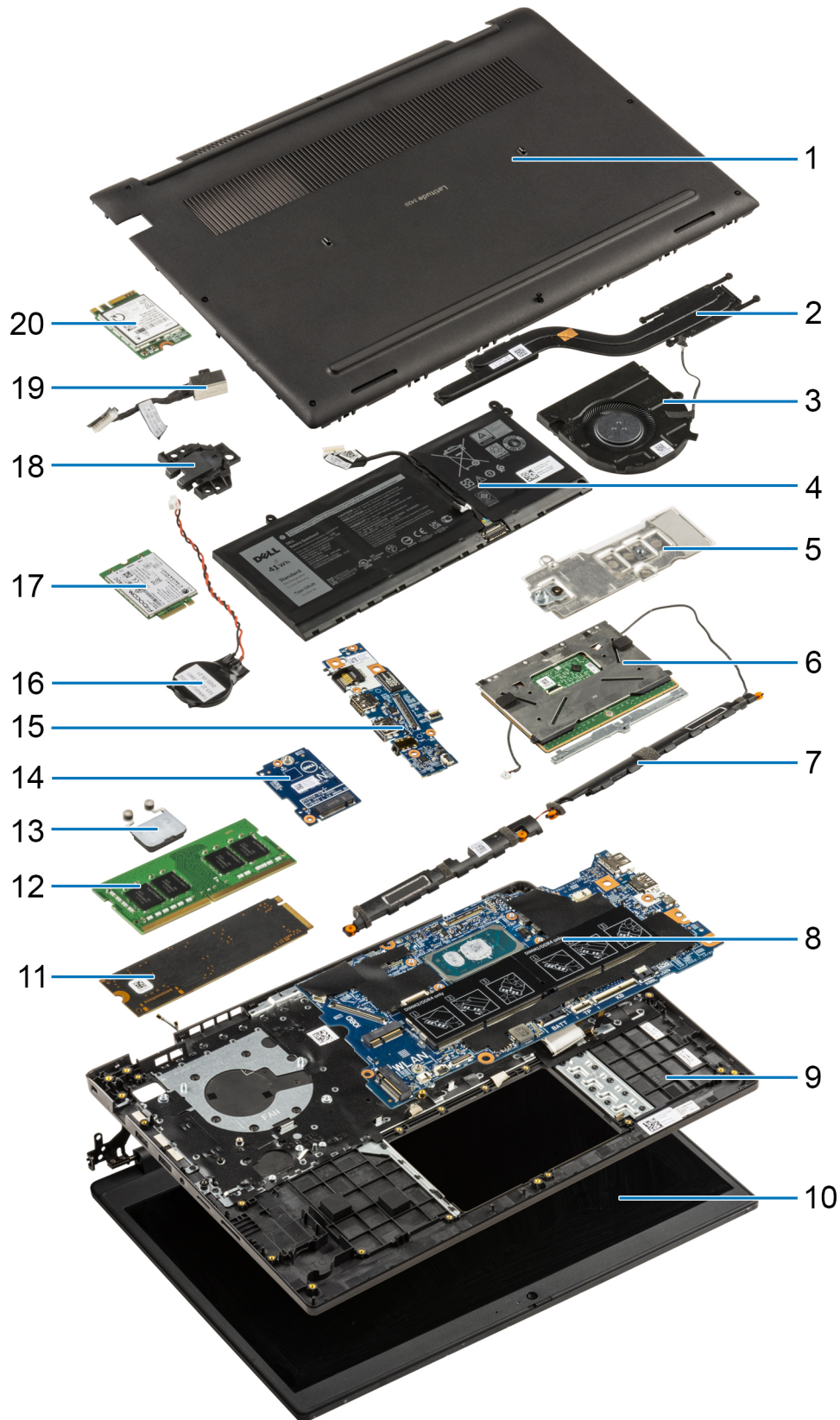

1. Base cover

2. Heatsink assembly
3. System fan
4. Battery
5. Solid-state drive conversion bracket
6. Touchpad
7. Speakers
8. System board
9. Computer chassis/palmrest assembly
10. Display assembly
11. Solid-state drive
12. Memory module
13. Power-button board
14. WWAN I/O board
15. I/O board
16. Coin-cell battery
17. WWAN card
18. Ethernet port
19. Power adapter port
20. WLAN

NOTE: Dell provides a list of components and their part numbers for the original system configuration purchased. These parts are available according to warranty coverages purchased by the customer. Contact your Dell sales representative for purchase options.

MicroSD-card

Removing the microSD-card

Prerequisites

1. Follow the procedure in [before working inside your computer](#).

About this task

The following image provides a visual representation of the microSD-card removal procedure.



Steps

1. Push the microSD-card to eject it from the slot.
2. Remove the microSD-card from the system.

Installing the MicroSD-card

Prerequisites

If you are replacing a component, remove the existing component before performing the installation procedure.

About this task

The following image provides a visual representation of the MicroSD-card installation procedure.



Steps

Insert the microSD-card into its slot until it clicks into place.

Next steps

1. Follow the procedure in [after working inside your computer](#).

SIM card tray

Removing the SIM card tray

Prerequisites

1. Follow the procedure in [before working inside your computer](#).
2. Remove the [microSD-card](#).

About this task

 **NOTE:** The following steps are applicable only for 4G LTE enabled systems.

The following image provides a visual representation of the SIM card tray removal procedure.

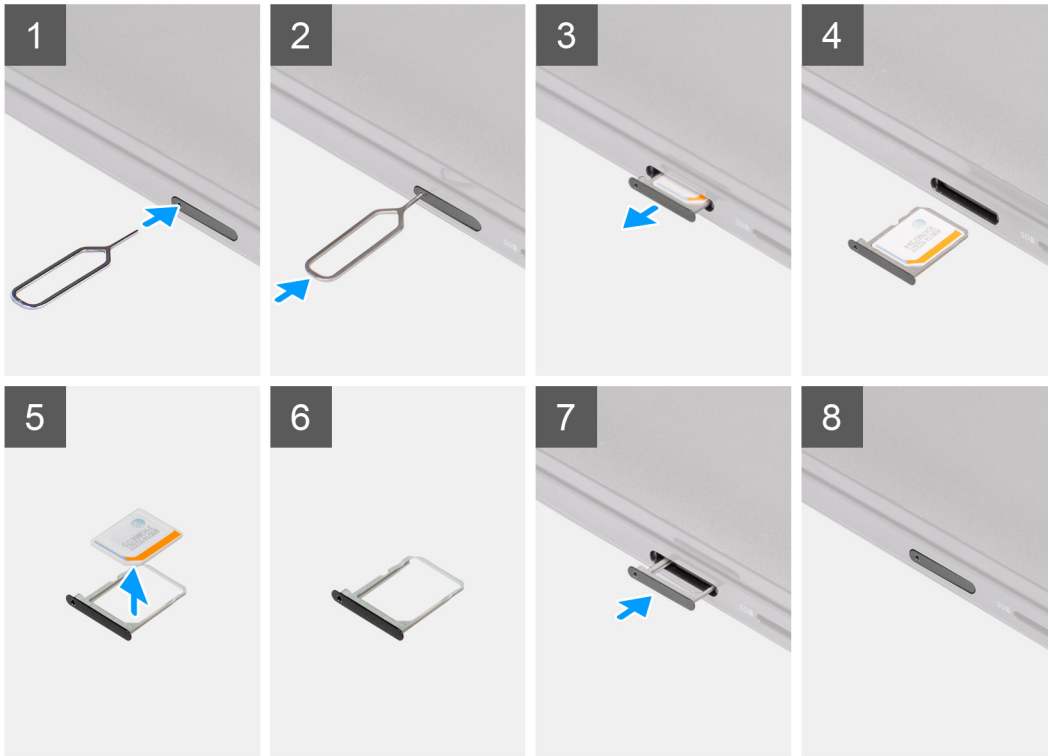

Steps

1. Insert the SIM card removal pin into the release hole to release the SIM card tray.
2. Push the pin to disengage the lock, and eject the SIM card tray.
3. Slide the SIM card tray out of the slot on the computer.
4. Remove the MicroSIM-card from the SIM tray.
5. Slide the SIM card tray back into the slot on the computer.

Installing the SIM card tray

Prerequisites

If you are replacing a component, remove the necessary component before the installation procedure.

About this task

 **NOTE:** The following steps are applicable only for 4G LTE enabled systems.

The following image provides a visual representation of the SIM card tray installation procedure.

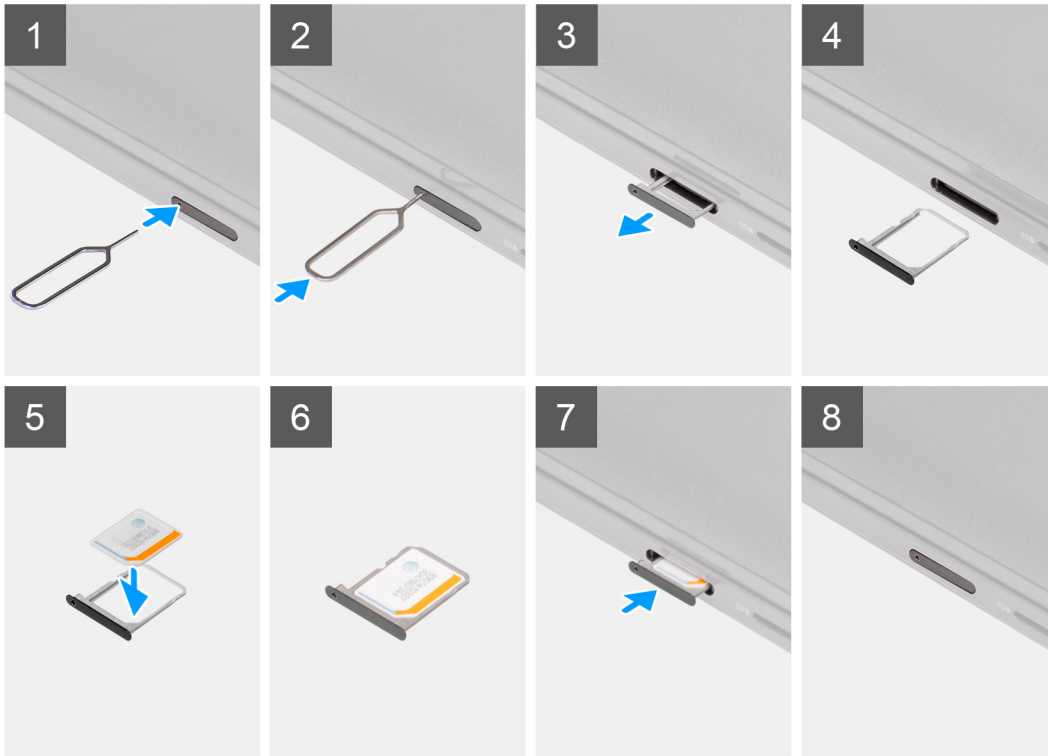

Steps

1. Insert the SIM card removal pin into the release hole to remove the SIM card tray.
2. Push the pin to disengage the lock, and eject the SIM card tray.
3. Slide the SIM card tray out of the slot on the computer.
4. Align and place the MicroSIM-card in the dedicated slot on the SIM card tray.
5. Slide the SIM card tray back into the slot on the computer.

Next steps

1. Install the [microSD-card](#).
2. Follow the procedure in [after working inside your computer](#).

Base cover

Removing the base cover

Prerequisites

1. Follow the procedure in [before working inside your computer](#).
2. Remove the [microSD-card](#).
3. Remove the [SIM card tray](#) for 4G LTE enabled systems.
4. Enter the [service mode](#).

About this task

The following images indicate the location of the base cover and provide a visual representation of the removal procedure.

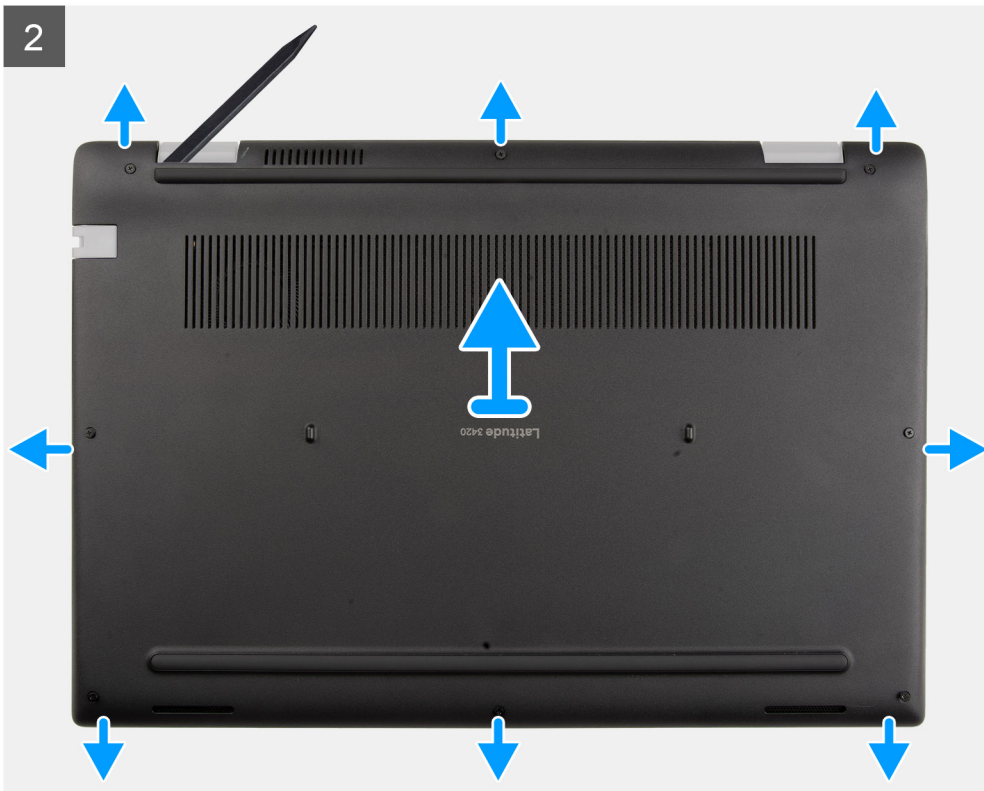

Steps

1. Loosen the eight captive screws that secure the base cover to the palmrest assembly.
2. Using a plastic scribe, pry open the base cover starting from the recesses located in the U-shaped indents near the hinges at the top edge of the base cover.
3. Carefully lift and remove the base cover from the chassis.

i **NOTE:** Be careful of the latches while removing the base cover as the latches may break.

Installing the base cover

Prerequisites

If you are replacing a component, remove the existing component before performing the installation procedure.

About this task

The following images indicate the location of the battery and provide a visual representation of the installation procedure.

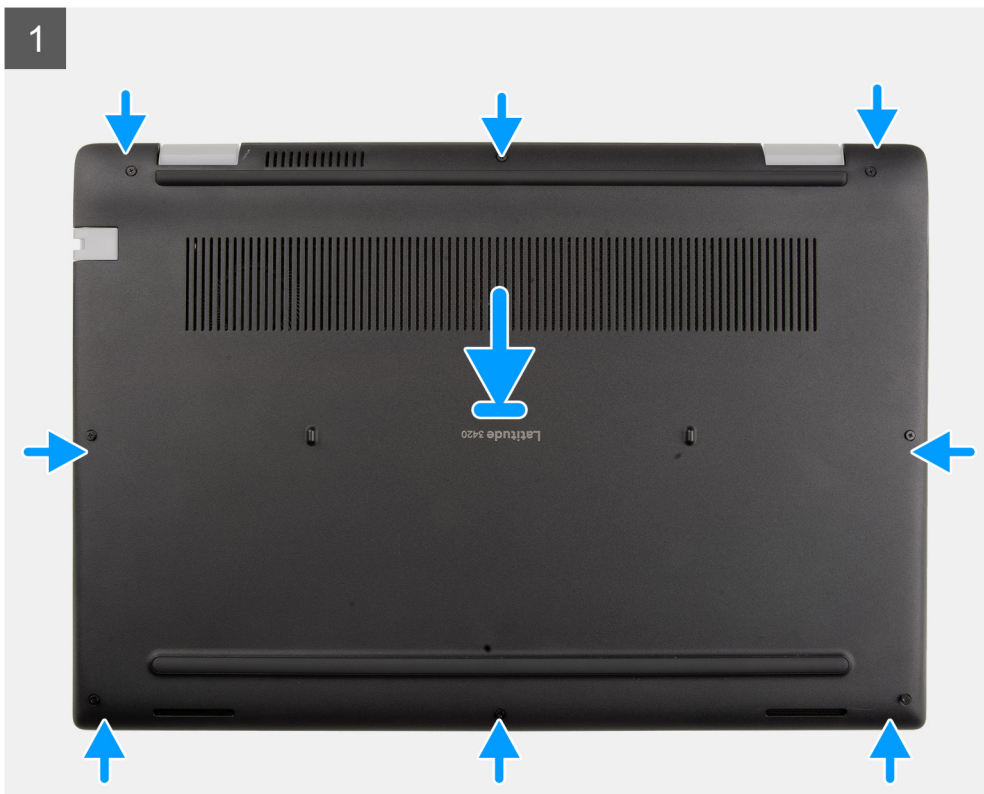



8x



Steps

1. Align and place the base cover on the palmrest assembly, and snap the base cover latches into place.
2. Tighten the eight captive screws to secure the base cover to the computer chassis.

Next steps

1. Exit the [service mode](#)
2. Install the [SIM card tray](#) for 4G LTE enabled systems.
3. Install the [microSD-card](#).
4. Follow the procedure in [after working inside your computer](#).

Memory module

Removing the memory module

Prerequisites

1. Follow the procedure in [before working inside your computer](#).
2. Remove the [microSD-card](#).
3. Remove the [SIM card tray](#) for 4G LTE enabled systems.
4. Enter the [service mode](#).
5. Remove the [base cover](#).

About this task

The following image indicates the location of the memory module and provides a visual representation of the removal procedure.

NOTE: The location of the memory module may vary depending on your system.

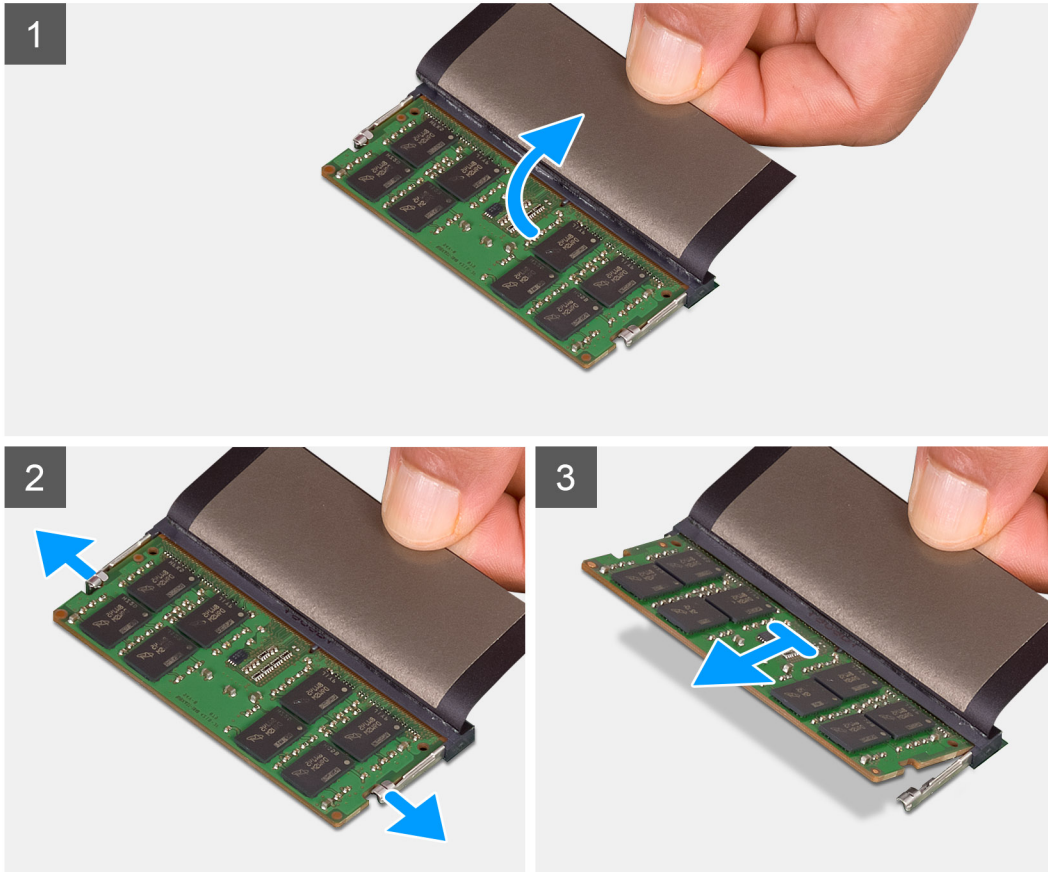
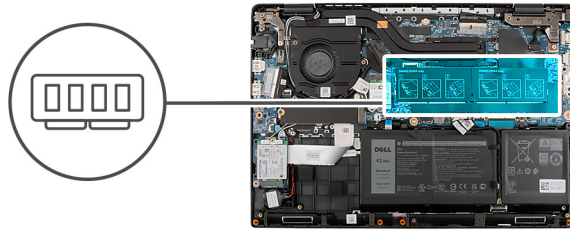

Steps

1. Lift the mylar to uncover the memory module.
2. Pry the retention clips securing the memory module slot until the memory module pops-up.
3. Remove the memory module from the memory module slot.

Installing the memory module

Prerequisites

If you are replacing a component, remove the existing component before performing the installation procedure.

About this task

The following image indicates the location of the memory module and provides a visual representation of the installation procedure.

NOTE: The location of the memory module may vary depending on your system.

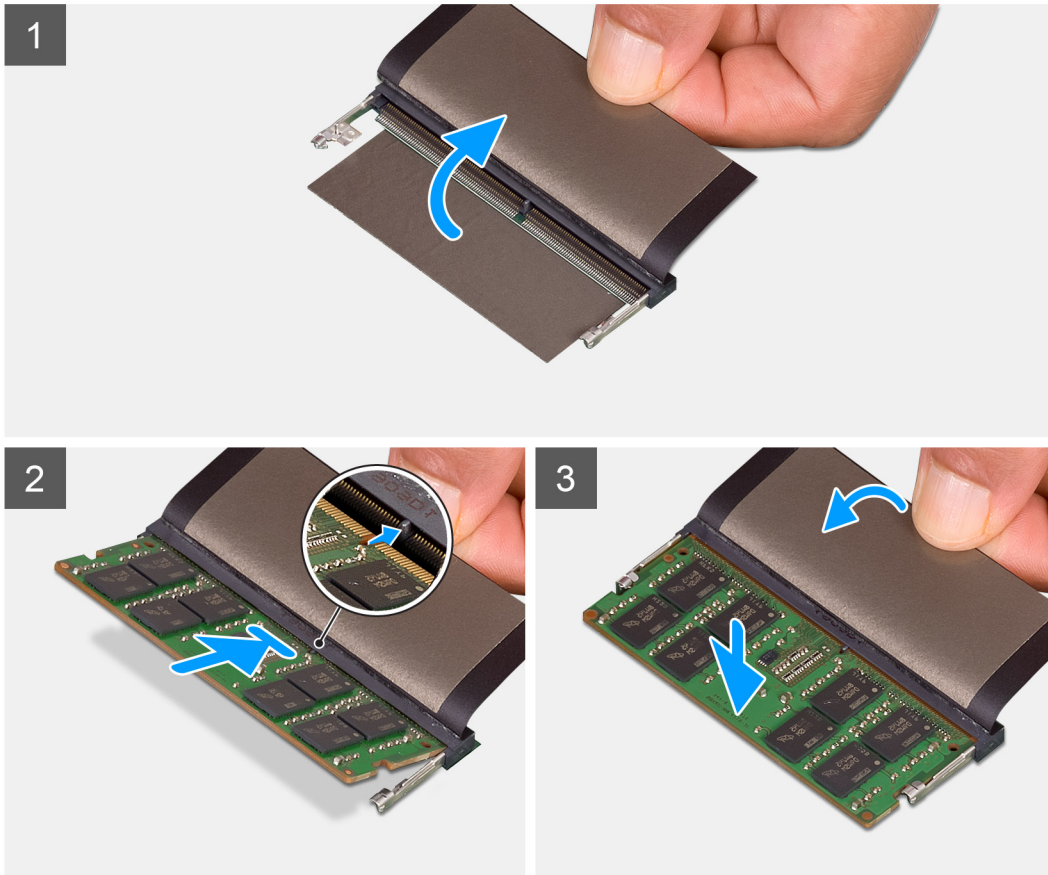
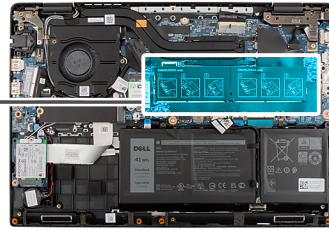
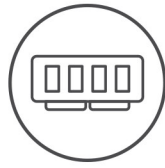

Steps

1. Lift the mylar to find the memory module slot.
2. Align the notch on the memory module with the tab on the memory-module slot.
3. Slide the memory module firmly into the slot at an angle.
4. Press the memory module down until it clicks into place.

i **NOTE:** If you do not hear the click, remove the memory module and reinstall it.

Next steps

1. Install the [base cover](#).
2. Exit the [service mode](#).
3. Install the [SIM card tray](#) for 4G LTE enabled systems.
4. Install the [microSD-card](#).
5. Follow the procedure in [after working inside your computer](#).

M.2 solid-state drive

Removing the M.2 2230 solid-state drive

Prerequisites

1. Follow the procedure in [before working inside your computer](#).
2. Remove the [microSD-card](#).
3. Remove the [SIM card tray](#) for 4G LTE enabled systems.
4. Enter the [service mode](#).
5. Remove the [base cover](#).

About this task

The following image indicates the location of the solid-state drive and provides a visual representation of the removal procedure.

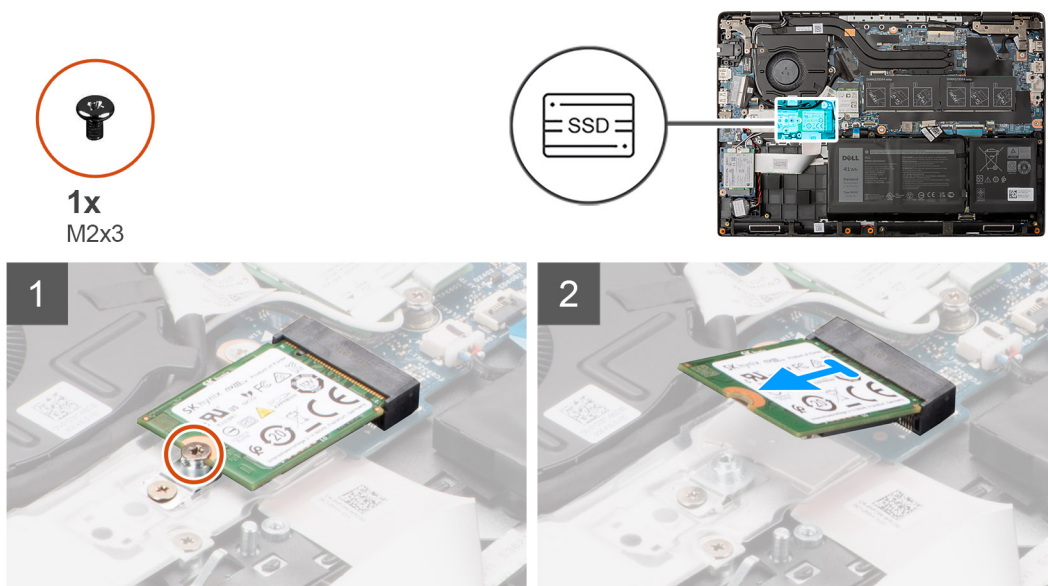

Steps

1. Remove the (M2x3) screw that secures the solid-state drive to the system board.
2. Slide and remove the solid-state drive from the solid-state drive slot on the system board.

Installing the M.2 2230 solid-state drive

Prerequisites

If you are replacing a component, remove the existing component before performing the installation procedure.

About this task

The following image indicates the location of the solid-state drive and provides a visual representation of the installation procedure.



1x
M2x3

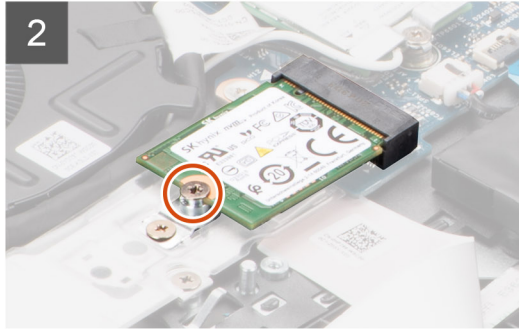
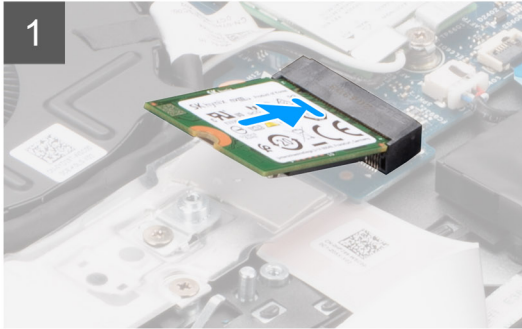
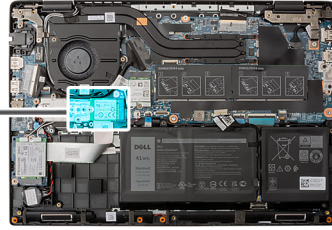

Steps

1. Align the notch on the solid-state drive with the tab on the solid-state drive slot.
2. Slide the solid-state drive into the solid-state drive slot on the system board.
3. Replace the (M2x3) screw to secure the solid-state drive to the system board.

Next steps

1. Install the [base cover](#).
2. Exit the [service mode](#)
3. Install the [SIM card tray](#) for 4G LTE enabled systems.
4. Install the [microSD-card](#).
5. Follow the procedure in [after working inside your computer](#).

Removing the M.2 2280 solid-state drive

Prerequisites

1. Follow the procedure in [before working inside your computer](#).
2. Remove the [microSD-card](#).
3. Remove the [SIM card tray](#) for 4G LTE enabled systems.
4. Enter the [service mode](#).
5. Remove the [base cover](#).

About this task

The following image indicates the location of the solid-state drive and provides a visual representation of the removal procedure.



1x
M2x3

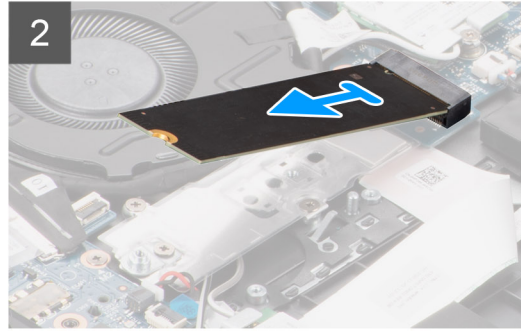
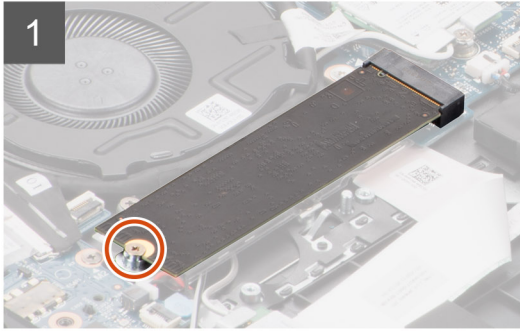
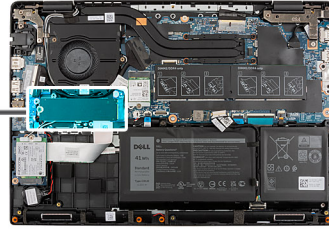

Steps

1. Remove the (M2x3) screw that secures the solid-state drive to the system board.
2. Slide and remove the solid-state drive from the solid-state drive slot on the system board.

Installing the M.2 2280 solid-state drive

Prerequisites

If you are replacing a component, remove the existing component before performing the installation procedure.

About this task

The following image indicates the location of the solid-state drive and provides a visual representation of the installation procedure.



1x
M2x3

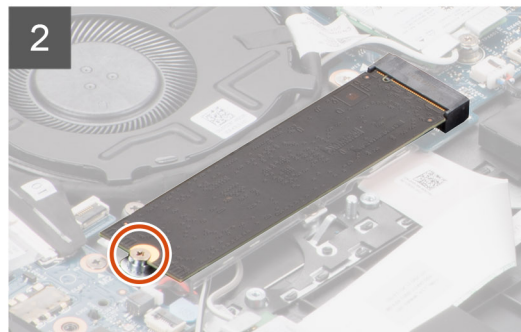
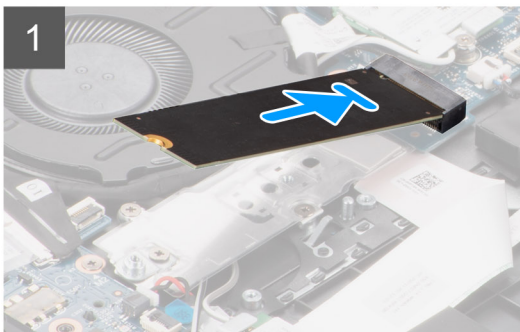
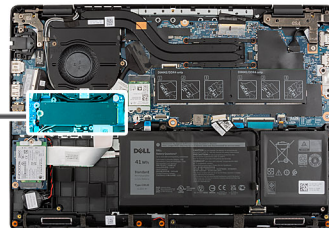

Steps

1. Align the notch on the solid-state drive with the tab on the solid-state drive slot.

2. Slide the solid-state drive into the solid-state drive slot on the system board.
3. Replace the (M2x3) screw to secure the solid-state drive to the system board.

Next steps

1. Install the [base cover](#).
2. Exit the [service mode](#)
3. Install the [SIM card tray](#) for 4G LTE enabled systems.
4. Install the [microSD-card](#).
5. Follow the procedure in [after working inside your computer](#).

Battery cable

Removing the battery cable

Prerequisites

1. Follow the procedure in [before working inside your computer](#).
2. Remove the [microSD-card](#).
3. Remove the [SIM card tray](#) for 4G LTE enabled systems.
4. Remove the [base cover](#).

About this task

The following image indicates the location of the battery cable and provides a visual representation of the removal procedure.

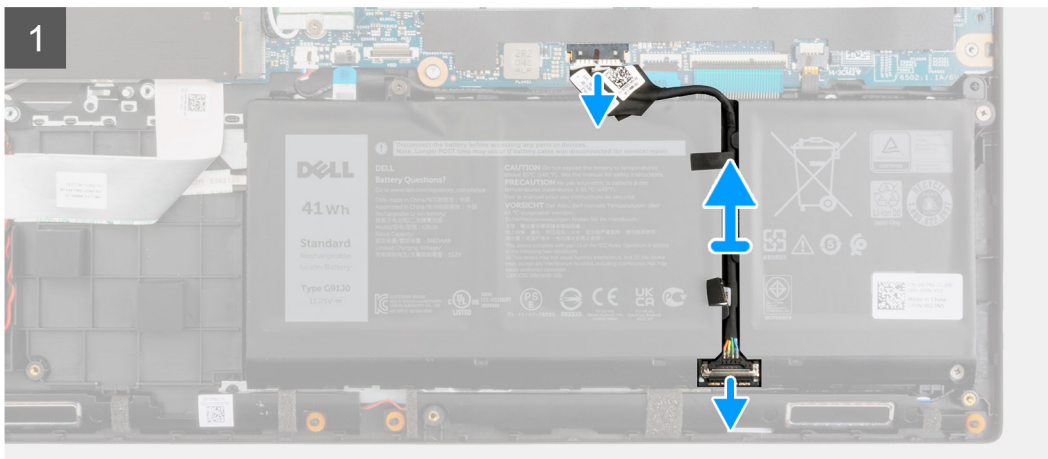
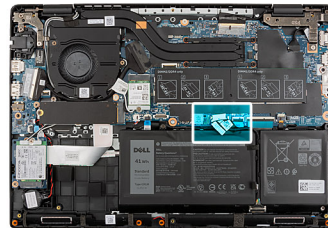

Steps

1. Disconnect the battery cable from the connector on the system board.
2. Slide the metal above the connector on the battery to unlock.
3. Peel the adhesive tapes and unroute the battery cable from routing channel in the battery.
4. Disconnect the battery cable from the connector on the battery.

Installing the battery cable

Prerequisites

If you are replacing a component, remove the existing component before performing the installation procedure.

About this task

The following image indicates the location of the battery cable and provides a visual representation of the installation procedure.

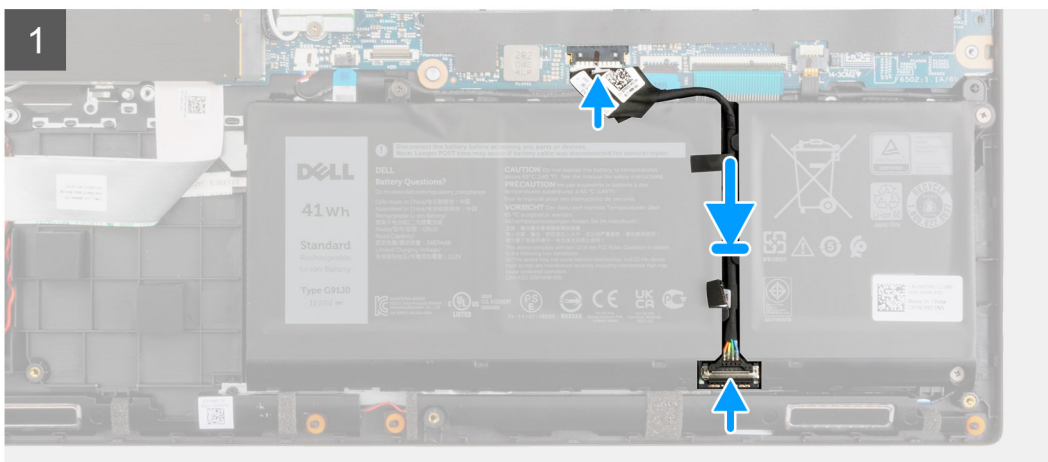
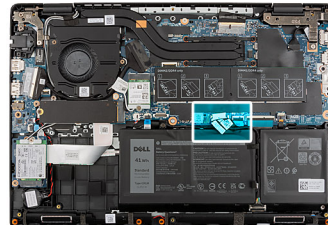

Steps

1. Connect the battery cable to the connector on the battery.
2. Slide the metal above the connector on the battery to lock.
3. Route the battery cable through the routing channel in the battery and adhere the adhesive tapes.
4. Connect the battery cable to the connector on the system board.

Next steps

1. Install the [base cover](#).
2. Install the [SIM card tray](#) for 4G LTE enabled systems.
3. Install the [microSD-card](#).
4. Follow the procedure in [after working inside your computer](#).

M.2 solid-state drive conversion bracket

Replacing the M.2 solid-state drive conversion bracket

Prerequisites

1. Follow the procedure in [before working inside your computer](#).
2. Remove the [microSD-card](#).
3. Remove the [SIM card tray](#) for 4G LTE enabled systems.

4. Enter the [service mode](#).
5. Remove the [base cover](#).
6. Remove the [M.2 SSD](#).

About this task

The following image indicates the location of the M.2 solid-state drive conversion bracket and how it can be used to fit solid-state drives of different length.



1x
M2x3

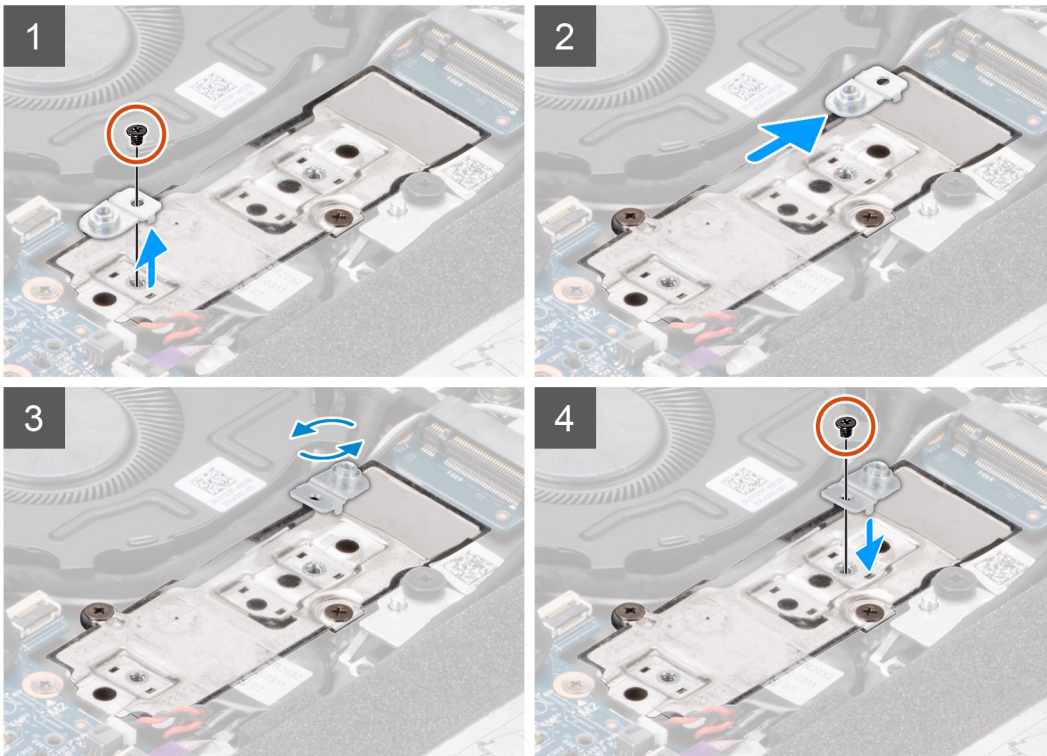
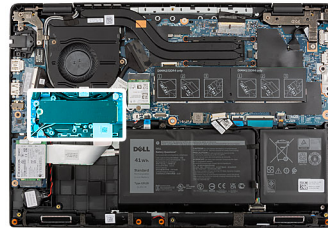

Steps

1. Remove the (M2x3) screw that secures the solid-state drive conversion bracket to the solid-state drive conversion plate.
2. Depending on the type of solid-state drive (M.2 2230/ M.2 2280), turn, align and place the solid-state drive conversion bracket into the slot.
3. Install the (M2x3) screw to secure the solid-state drive conversion bracket to the solid-state drive conversion plate.

M.2 solid-state drive conversion plate

Removing the M.2 solid-state drive conversion plate

Prerequisites

1. Follow the procedure in [before working inside your computer](#).
2. Remove the [microSD-card](#).

3. Remove the [SIM card tray](#) for 4G LTE enabled systems.
4. Enter the [service mode](#).
5. Remove the [base cover](#).
6. Remove the [M.2 SSD](#).

About this task

The following image indicates the location of the M.2 solid-state drive conversion plate and provides a visual representation of the removal procedure.



2x
M2x3

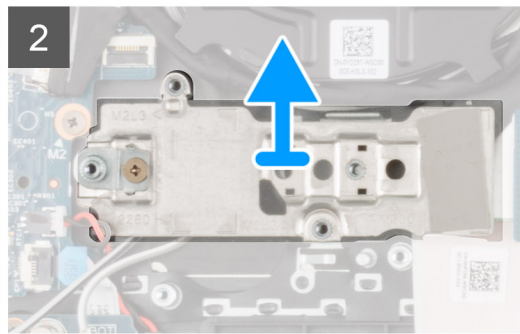
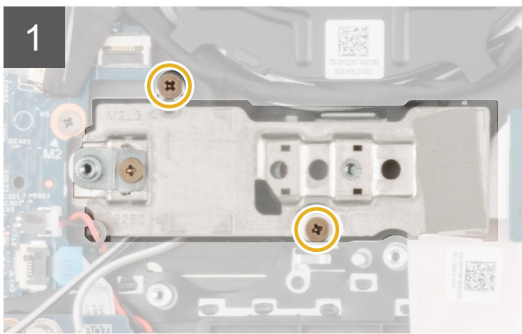
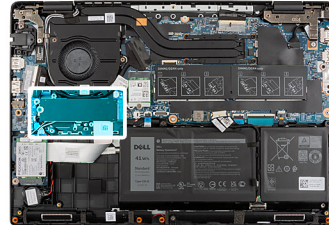

Steps

1. Remove the two (M2x3) screws that secures the solid-state drive conversion plate to the system board.
2. Lift and remove the solid-state drive conversion plate from the solid-state drive slot on the system board.

Installing the M.2 solid-state drive conversion plate

Prerequisites

If you are replacing a component, remove the existing component before performing the installation procedure.

About this task

The following image indicates the location of the M.2 solid-state drive conversion plate and provides a visual representation of the installation procedure.



2x
M2x3

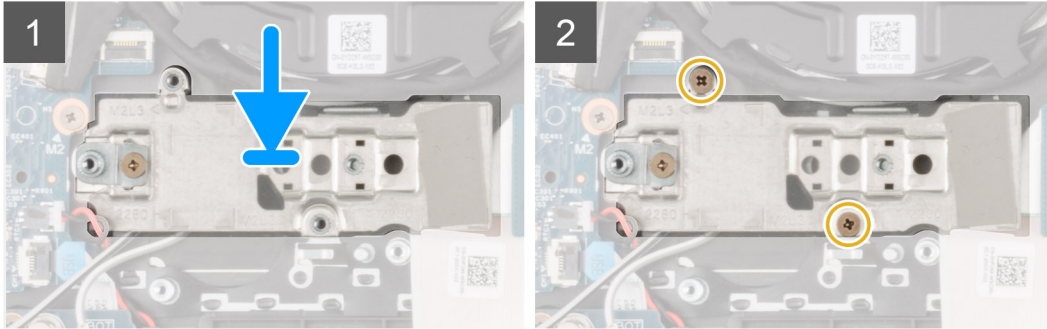
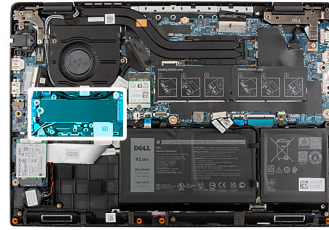

Steps

1. Align and place the solid-state drive conversion plate on the system board.
2. Install the two (M2x3) screws to secure the solid-state drive conversion plate to the system board.

Next steps

1. Install the [M.2 SSD](#).
2. Install the [base cover](#).
3. Exit the [service mode](#)
4. Install the [SIM card tray](#) for 4G LTE enabled systems.
5. Install the [microSD-card](#).
6. Follow the procedure in [after working inside your computer](#).

Hard-disk drive assembly

Removing the hard-disk drive assembly

Prerequisites

1. Follow the procedure in [before working inside your computer](#).
2. Remove the [microSD-card](#).
3. Remove the [SIM card tray](#) for 4G LTE enabled systems.
4. Enter the [service mode](#).
5. Remove the [base cover](#).

About this task

The following image indicates the location of the hard-disk drive assembly and provides a visual representation of the removal procedure.

 **NOTE:** The following steps are applicable only for systems shipped with a 3-cell battery. You cannot install the 2.5-inch SATA hard-drive on systems with a 4-cell battery.



3x
M2x4.5

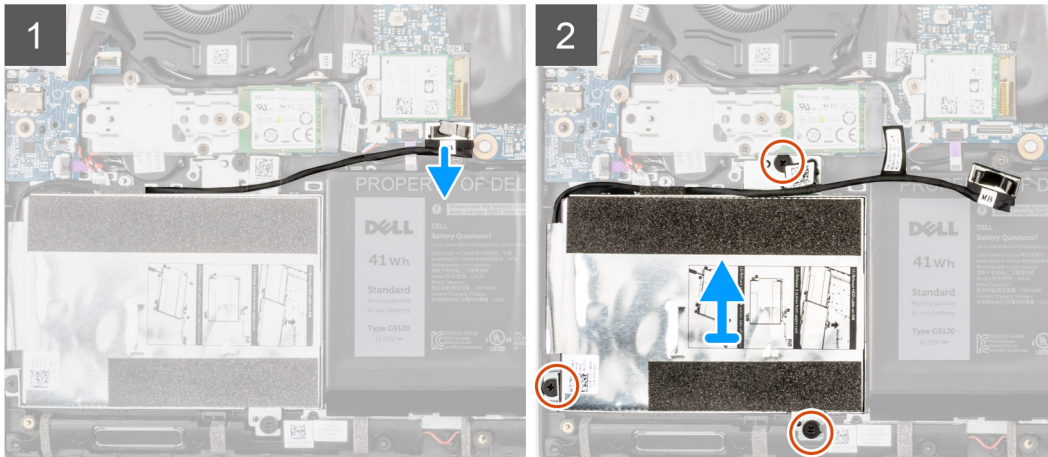
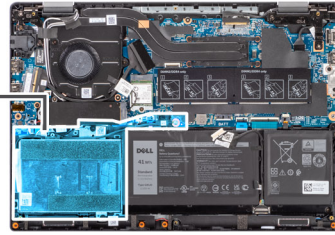

Steps

1. Lift and disconnect the hard-disk drive cable from the connector on the system board.
2. Loosen the three (M2X4.5) screws that secure the hard-disk drive assembly to the palmrest assembly.
3. Lift and remove the hard-disk drive assembly from the slot on the palmrest assembly.

Removing the hard-disk drive bracket

Prerequisites

1. Follow the procedure in [before working inside your computer](#).
2. Remove the [microSD-card](#).
3. Remove the [SIM card tray](#) for 4G LTE enabled systems.
4. Enter the [service mode](#).
5. Remove the [base cover](#).
6. Remove the [hard-disk drive](#).

About this task

The following image indicates the location of the hard-disk drive bracket and provides a visual representation of the removal procedure.



4x
M3x3

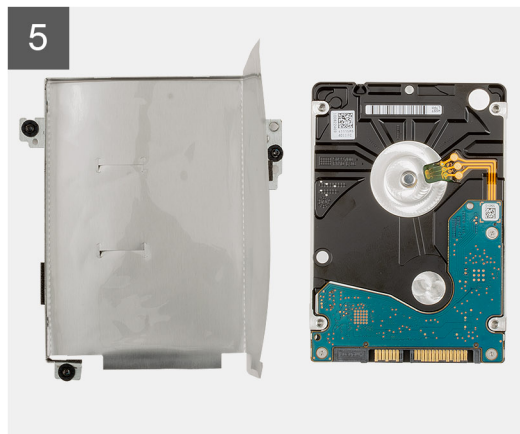
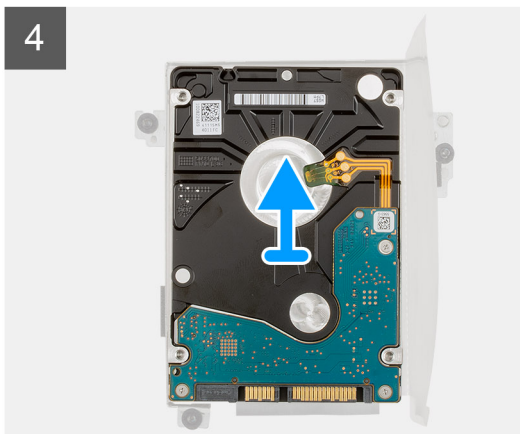
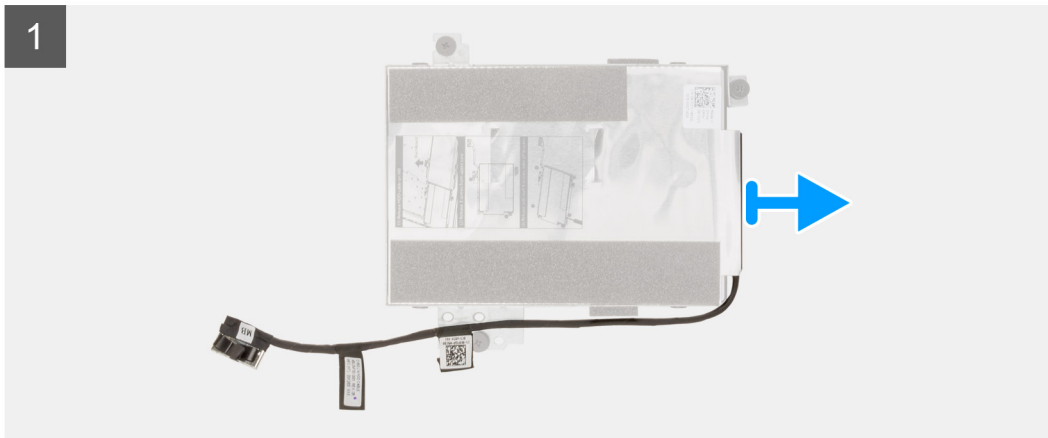

Steps

1. Disconnect the hard-disk drive cable from the connector on the hard-disk drive bracket.
2. Remove the four (M3x3) screws that secure the hard-disk drive to the hard-disk drive bracket.
3. Flip the hard-disk drive bracket, lift the silver foil, and remove the hard-disk drive from the hard-disk drive bracket.

Installing the hard-disk drive bracket

Prerequisites

If you are replacing a component, remove the existing component before performing the installation procedure.

About this task

The following image indicates the location of the hard-disk drive bracket and provides a visual representation of the installation procedure.



4x
M3x3

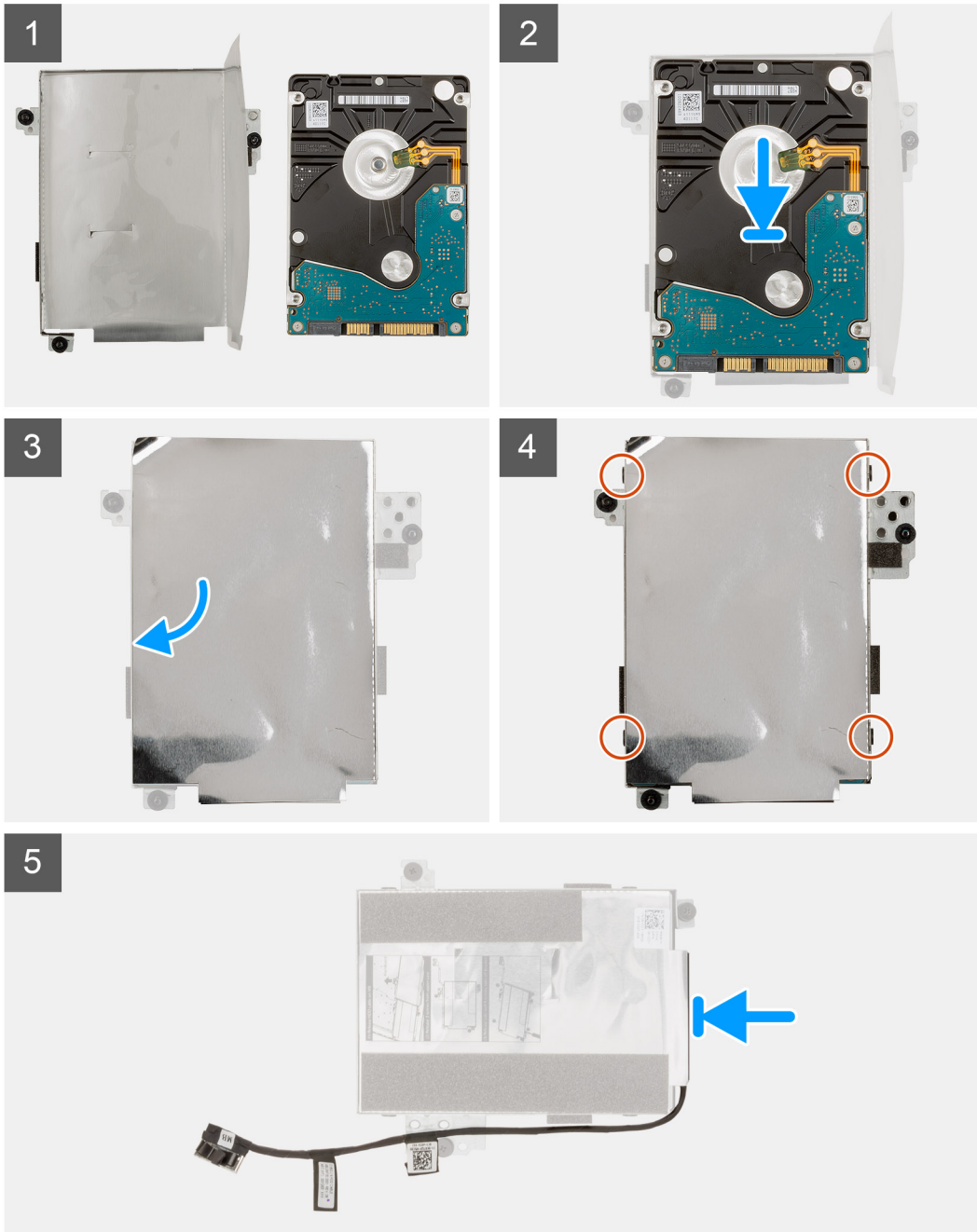

Steps

1. Lift the silver foil, align and place the hard-disk drive in the hard-disk drive bracket.
2. Install the four (M3x3) screws to secure the hard-disk drive to the hard-disk drive bracket.
3. Connect the hard-disk drive cable to the connector on the hard-disk drive bracket.

Next steps

1. Install the [hard-disk drive](#).
2. Install the [base cover](#).
3. Exit the [service mode](#)
4. Install the [SIM card tray](#) for 4G LTE enabled systems.
5. Install the [microSD-card](#).
6. Follow the procedure in [after working inside your computer](#).

Installing the hard-disk drive assembly

Prerequisites

If you are replacing a component, remove the existing component before performing the installation procedure.

About this task

The following image indicates the location of the hard-disk drive assembly and provides a visual representation of the installation procedure.

NOTE: The following steps are applicable only for systems shipped with a 3-cell battery. You cannot install the 2.5-inch SATA hard-drive on systems with a 4-cell battery.

NOTE: Systems that are shipped with 3-cell battery contain a rubber bumper that must be removed manually before installing the hard-disk drive assembly.



3x
M2x4.5

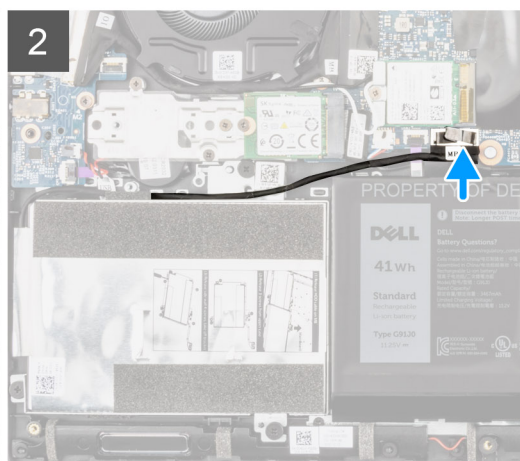
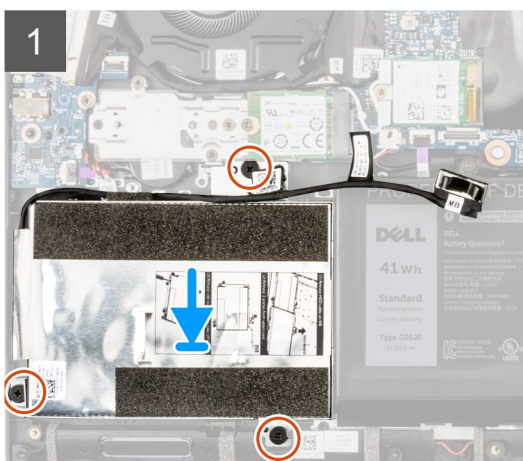
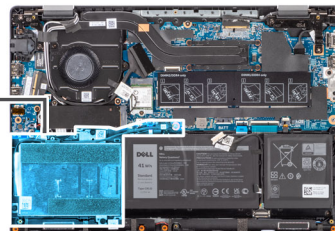

Steps

1. Align and place the hard-disk drive assembly in the slot on the palmrest assembly.
2. Tighten the three (M2X4.5) screws to secure the hard-disk drive assembly to the palmrest assembly.

3. Connect the hard-disk drive cable to the connector on the system board.

Next steps

1. Install the [base cover](#).
2. Exit the [service mode](#)
3. Install the [SIM card tray](#) for 4G LTE enabled systems.
4. Install the [microSD-card](#).
5. Follow the procedure in [after working inside your computer](#).

WLAN card

Removing the WLAN card

Prerequisites

1. Follow the procedure in [before working inside your computer](#).
2. Remove the [microSD-card](#).
3. Remove the [SIM card tray](#) for 4G LTE enabled systems.
4. Enter the [service mode](#).
5. Remove the [base cover](#).

About this task

The following image indicates the location of the WLAN card and provides a visual representation of the removal procedure.

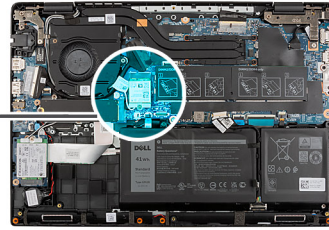

Steps

1. Remove the screw (M2x3) that secures WLAN card bracket to the WLAN card on the system board.
2. Lift and remove the WLAN card bracket from the WLAN card that secures the two antenna cables.
3. Disconnect the antenna cables from the connectors on the WLAN card.
4. Disconnect and remove the WLAN card from the WLAN card slot.

Installing the WLAN card

Prerequisites

If you are replacing a component, remove the existing component before performing the installation procedure.

About this task

The following image indicates the location of the WLAN card and provides a visual representation of the installation procedure.



1x
M2x3

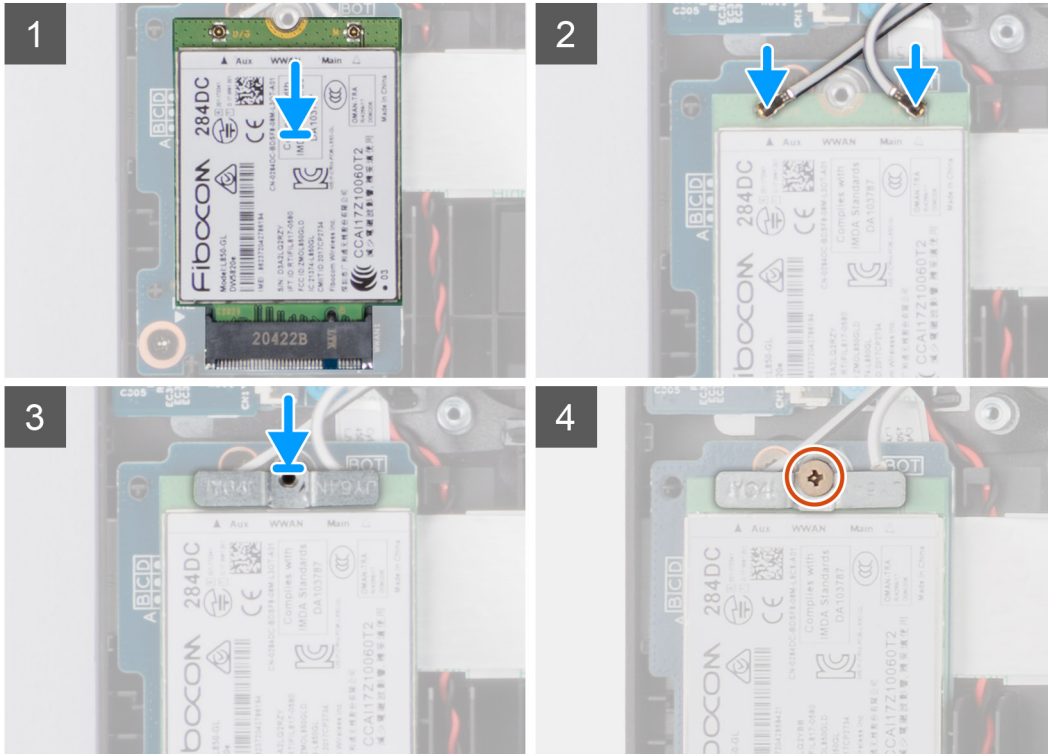
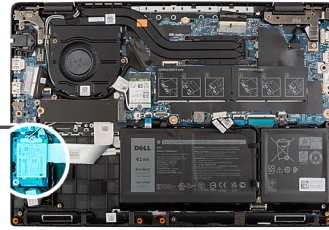

Steps

1. Connect the two antenna cables to the connectors on the WLAN card.

NOTE: The antenna cable connectors are fragile and utmost care should be taken while replacing them.

Table 2. Antenna cable guide

Cable color	Connector
White cable (Main)	White triangle (△) on the WLAN module of the system board
Black cable (Aux)	Solid triangle (▲) on the WLAN module of the system board

2. Align the notch on the WLAN card with the tab on the WLAN card slot.
3. Slide the WLAN card at an angle into the WLAN card slot.
4. Align and place the WLAN card bracket on the WLAN card.
5. Install the screw (M2x3) to secure the WLAN card bracket on the WLAN card to the system board.

Next steps

1. Install the [base cover](#).
2. Exit the [service mode](#)
3. Install the [SIM card tray](#) for 4G LTE enabled systems.
4. Install the [microSD-card](#).
5. Follow the procedure in [after working inside your computer](#).

WWAN card

Removing the WWAN card

Prerequisites

1. Follow the procedure in [before working inside your computer](#).
2. Remove the [microSD-card](#).
3. Remove the [SIM card tray](#) for 4G LTE enabled systems.
4. Enter the [service mode](#).
5. Remove the [base cover](#).

About this task

The following image indicates the location of the WWAN card and provides a visual representation of the removal procedure.

 **NOTE:** The following steps are applicable only for 4G LTE enabled systems.

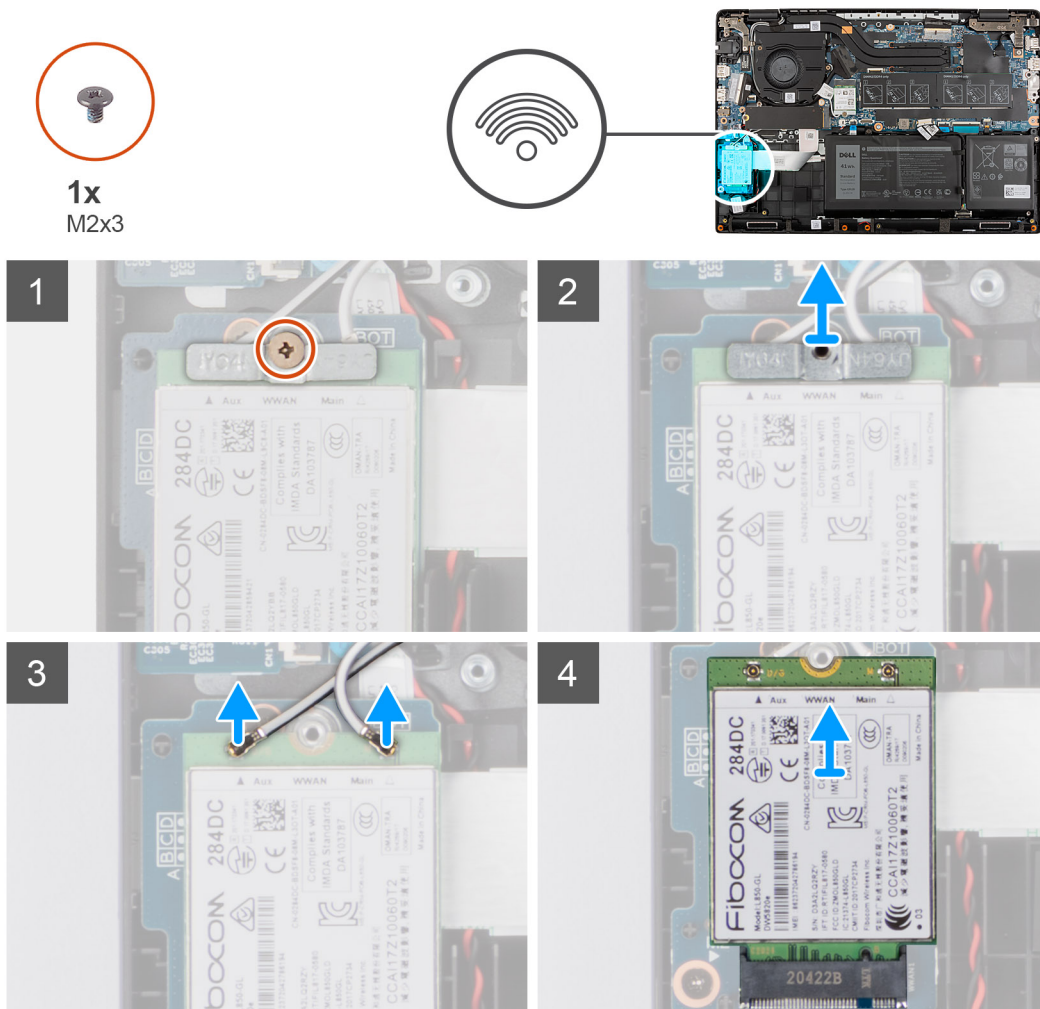

Steps

1. Open the mylar sheet that covers the WWAN card.
2. Remove the screw (M2x3) that secures WWAN card bracket to the WWAN card on the system board.
3. Lift and remove the WWAN card bracket from the WWAN card that secures the two antenna cables.
4. Disconnect the antenna cables from the connectors on the WWAN card.

5. Disconnect and remove the WWAN card from the WWAN card slot.

Installing the WWAN card

Prerequisites

If you are replacing a component, remove the existing component before performing the installation procedure.

About this task

The following image indicates the location of the WWAN card and provides a visual representation of the installation procedure.

NOTE: The following steps are applicable only for 4G LTE enabled systems.

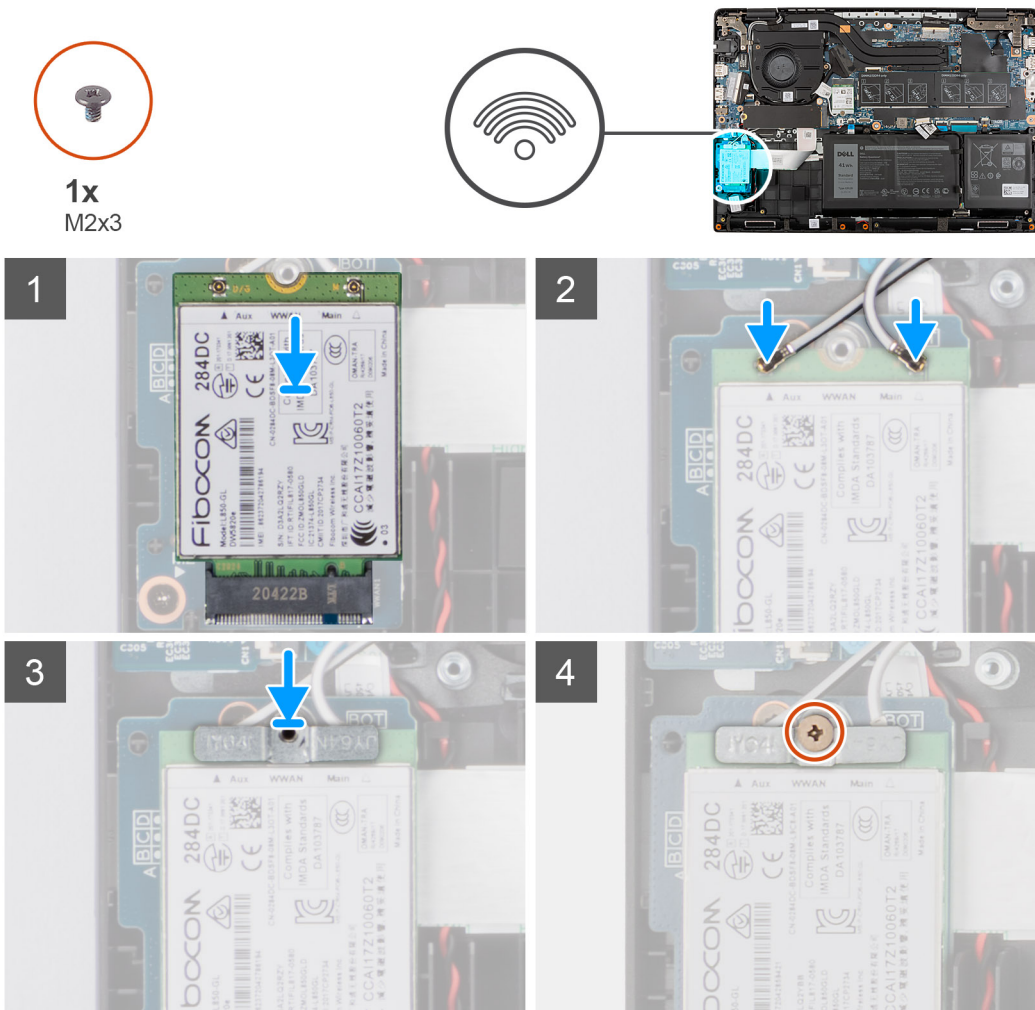

Steps

1. Connect the two antenna cables to the connectors on the WWAN card.

NOTE: The antenna cable connectors are fragile and utmost care should be taken while replacing them.

Table 3. Antenna cable guide

Cable color	Connector
White cable (Main)	White triangle (▲) on the WWAN module of the system board

Table 3. Antenna cable guide (continued)

Cable color	Connector
Black cable (Aux)	Solid triangle (▲) on the WWAN module of the system board

2. Align the notch on the WWAN card with the tab on the WWAN card slot.
3. Slide the WWAN card at an angle into the WWAN card slot.
4. Align and place the WWAN card bracket on the WWAN card.
5. Install the screw (M2x3) to secure the WWAN card bracket on the WWAN card to the system board.
6. Close the mylar sheet to cover the WWAN card.

Next steps

1. Install the [base cover](#).
2. Exit the [service mode](#)
3. Install the [SIM card tray](#) for 4G LTE enabled systems.
4. Install the [microSD-card](#).
5. Follow the procedure in [after working inside your computer](#).

System fan

Removing the system fan

Prerequisites

1. Follow the procedure in [before working inside your computer](#).
2. Remove the [microSD-card](#).
3. Remove the [SIM card tray](#) for systems enabled with 4G LTE.
4. Enter the [service mode](#).
5. Remove the [base cover](#).

About this task

The following image indicates the location of the system fan and provides a visual representation of the removal procedure.



2x
M2x3

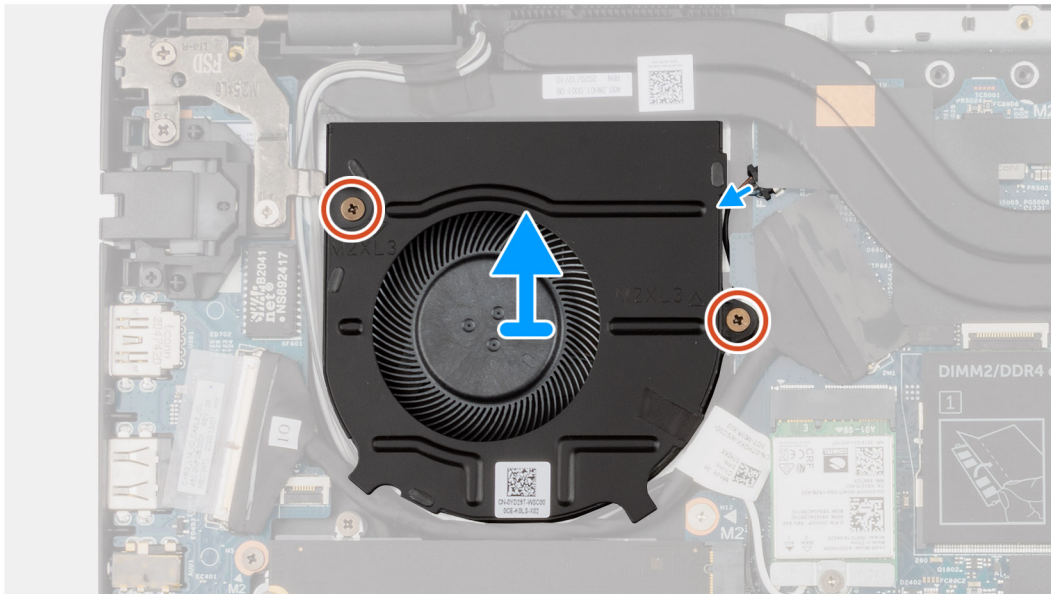
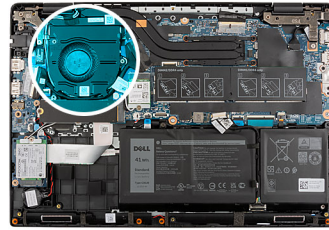

Steps

1. Disconnect the system fan cable from the connector on the system board.
2. Remove the two (M2x3) screws that secure the system fan to the palmrest assembly.
3. Lift and remove the system fan from the palmrest assembly.

Installing the system fan

Prerequisites

If you are replacing a component, remove the existing component before performing the installation procedure.

About this task

The following image indicates the location of the system fan and provides a visual representation of the installation procedure.



2x
M2x3

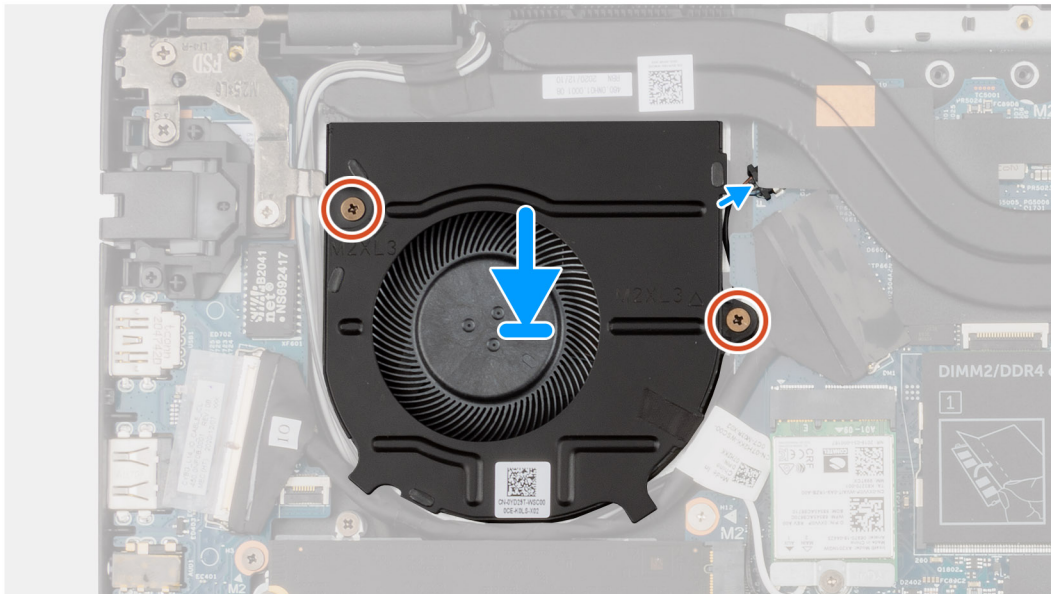
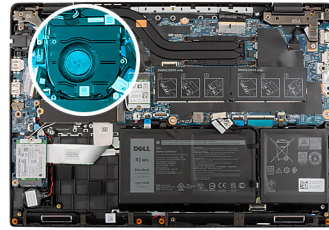

Steps

1. Align and place the system fan into the slot on the palmrest assembly.
2. Install the two (M2x3) screws to secure the system fan to the palmrest assembly.
3. Connect the system fan cable to the connector on the system board.

Next steps

1. Install the [base cover](#).
2. Exit the [service mode](#)
3. Install the [SIM card tray](#) for systems enabled with 4G LTE.
4. Install the [microSD-card](#).
5. Follow the procedure in [after working inside your computer](#).

Battery

Rechargeable Li-ion battery precautions

⚠ CAUTION:

- Exercise caution when handling rechargeable Li-ion batteries.
- Discharge the battery completely before removing it. Disconnect the AC power adapter from the system and operate the computer solely on battery power—the battery is fully discharged when the computer no longer turns on when the power button is pressed.
- Do not crush, drop, mutilate, or penetrate the battery with foreign objects.
- Do not expose the battery to high temperatures, or disassemble battery packs and cells.
- Do not apply pressure to the surface of the battery.
- Do not bend the battery.

- Do not use tools of any kind to pry on or against the battery.
- Ensure any screws during the servicing of this product are not lost or misplaced, to prevent accidental puncture or damage to the battery and other system components.
- If the battery gets stuck inside your computer as a result of swelling, do not try to release it as puncturing, bending, or crushing a rechargeable Li-ion battery can be dangerous. In such an instance, contact Dell technical support for assistance. See www.dell.com/contactdell.
- Always purchase genuine batteries from www.dell.com or authorized Dell partners and resellers.
- Swollen batteries should not be used and should be replaced and disposed properly. For guidelines on how to handle and replace swollen rechargeable Li-ion batteries, see [Handling swollen rechargeable Li-ion batteries](#).

Removing the 3-cell battery

Prerequisites

1. Follow the procedure in [before working inside your computer](#).
2. Remove the [microSD-card](#).
3. Remove the [SIM card tray](#) for 4G LTE enabled systems.
4. Remove the [base cover](#).

About this task

The following image indicates the location of the battery and provides a visual representation of the removal procedure.



3x
M2x3

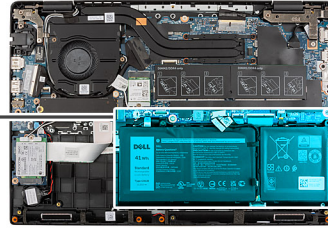
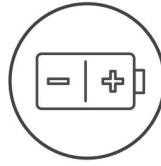

Steps

1. Disconnect the battery cable from the connector on the system board.
2. Remove the three (M2X3) screws that secure the battery in place.
3. Lift and remove the battery from the palmrest assembly.
4. Slide the metal above the connector on the battery to unlock.
5. Peel the adhesive tapes and unroute the battery cable from routing channel in the battery.
6. Disconnect the battery cable from the connector on the battery.

Installing the 3-cell battery

Prerequisites

If you are replacing a component, remove the existing component before performing the installation procedure.

About this task

The following image indicates the location of the battery and provides a visual representation of the installation procedure.



3x
M2x3

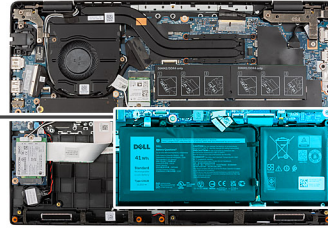
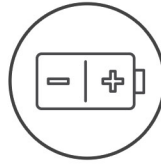

Steps

1. Connect the battery cable to the connector on the battery.
2. Slide the metal above the connector on the battery to lock.
3. Route the battery cable through the routing channel in the battery and adhere the adhesive tapes.
4. Align and place the battery in the slot on the palmrest assembly.
5. Install the three (M2X3) screws to secure the battery in place.
6. Connect the battery cable to the connector on the system board.

Next steps

1. Install the [base cover](#).
2. Install the [SIM card tray](#) for 4G LTE enabled systems.
3. Install the [microSD-card](#).
4. Follow the procedure in [after working inside your computer](#).

Removing the 4-cell battery

Prerequisites

1. Follow the procedure in [before working inside your computer](#).
2. Remove the [microSD-card](#).
3. Remove the [SIM card tray](#) for 4G LTE enabled systems.
4. Remove the [base cover](#).

About this task

The following image indicates the location of the battery and provides a visual representation of the removal procedure.

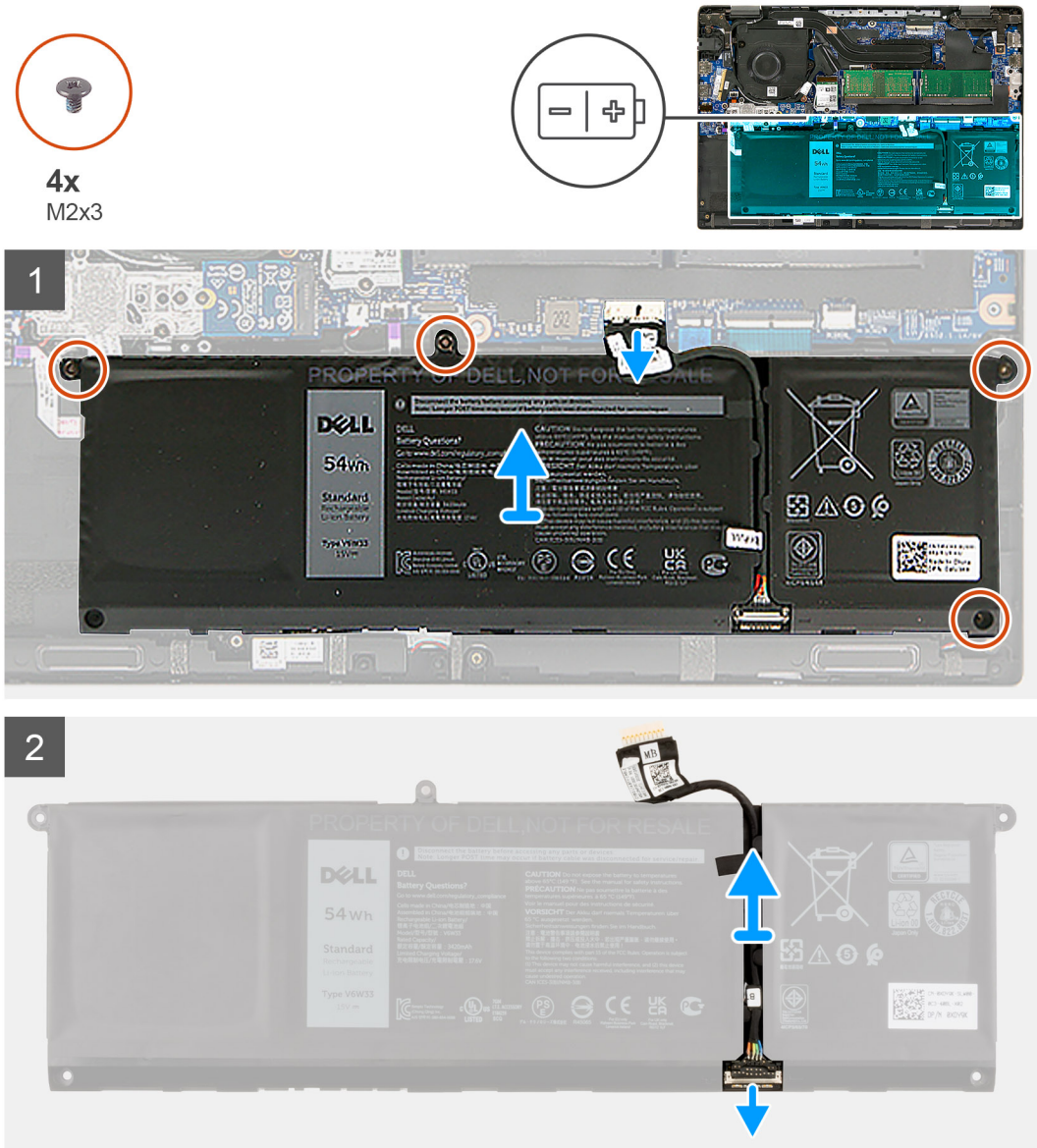

Steps

1. Disconnect the battery cable from the connector on the system board.
2. Remove the four (M2X3) screws that secure the battery in place.
3. Lift and remove the battery from the palmrest assembly.
4. Slide the metal above the connector on the battery to unlock.
5. Peel the adhesive tapes and unroute the battery cable from routing channel in the battery.

6. Disconnect the battery cable from the connector on the battery.

Installing the 4-cell battery

Prerequisites

If you are replacing a component, remove the existing component before performing the installation procedure.

About this task

The following image indicates the location of the battery and provides a visual representation of the installation procedure.



4x
M2x3

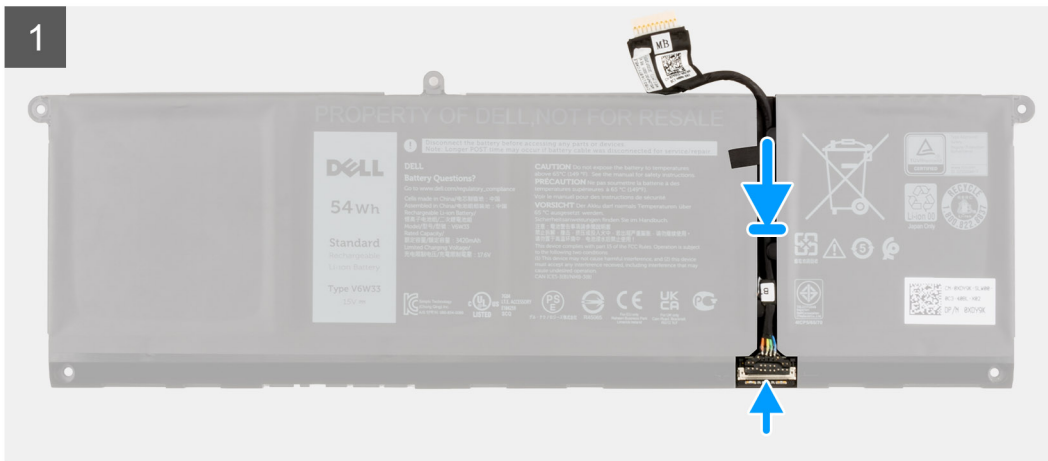
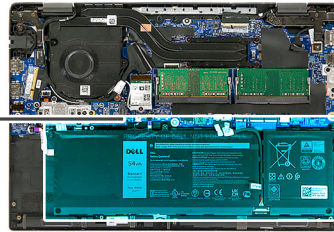
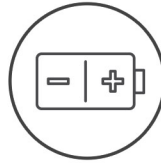

Steps

1. Connect the battery cable to the connector on the battery.
2. Slide the metal above the connector on the battery to lock.
3. Route the battery cable through the routing channel in the battery and adhere the adhesive tapes.
4. Align and place the battery in the slot on the palmrest assembly.
5. Install the four (M2X3) screws to secure the battery in place.
6. Connect the battery cable to the connector on the system board.

Next steps

1. Install the [base cover](#).
2. Install the [SIM card tray](#) for 4G LTE enabled systems.
3. Install the [microSD-card](#).
4. Follow the procedure in [after working inside your computer](#).

I/O cable

Removing the I/O cable

Prerequisites

1. Follow the procedure in [before working inside your computer](#).
2. Remove the [SIM card tray](#) for 4G LTE enabled systems.
3. Enter the [service mode](#).
4. Remove the [base cover](#).

About this task

The following image indicates the location of the I/O cable and provides a visual representation of the removal procedure.

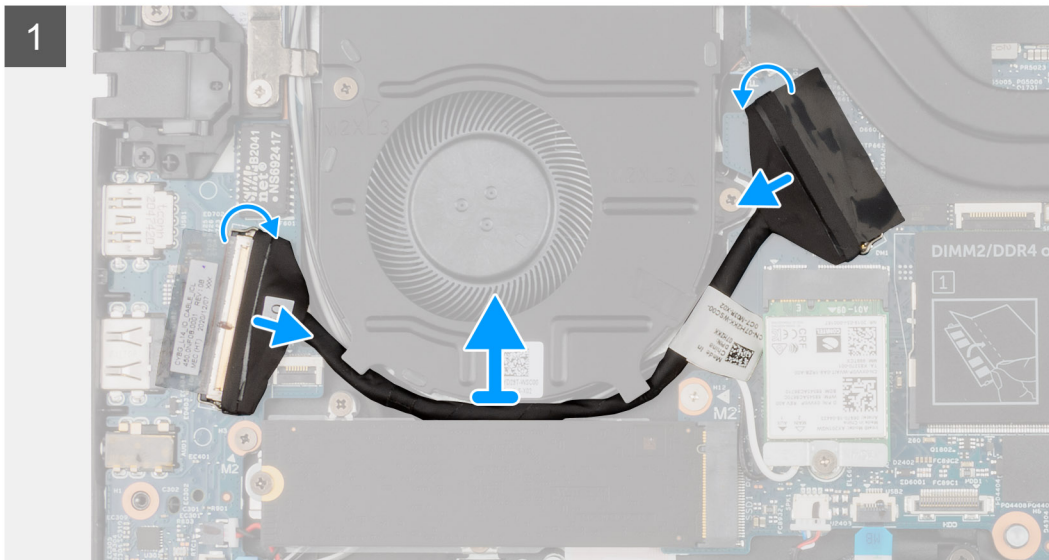
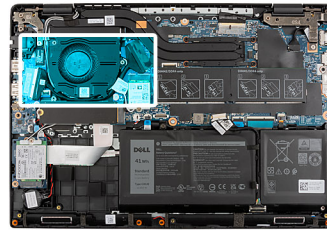

Steps

1. Peel the adhesive tape, open the latch and disconnect the I/O cable from the connector on the system board.
2. Peel the adhesive tape and unroute the I/O cable from the routing guides in the palmrest assembly.
3. Peel the adhesive tape, open the latch and disconnect the I/O cable from the connector on the I/O board.
4. Lift and remove the I/O cable from the palmrest assembly.

Installing the I/O cable

Prerequisites

If you are replacing a component, remove the existing component before performing the installation procedure.

About this task

The following image indicates the location of the I/O cable and provides a visual representation of the installation procedure.

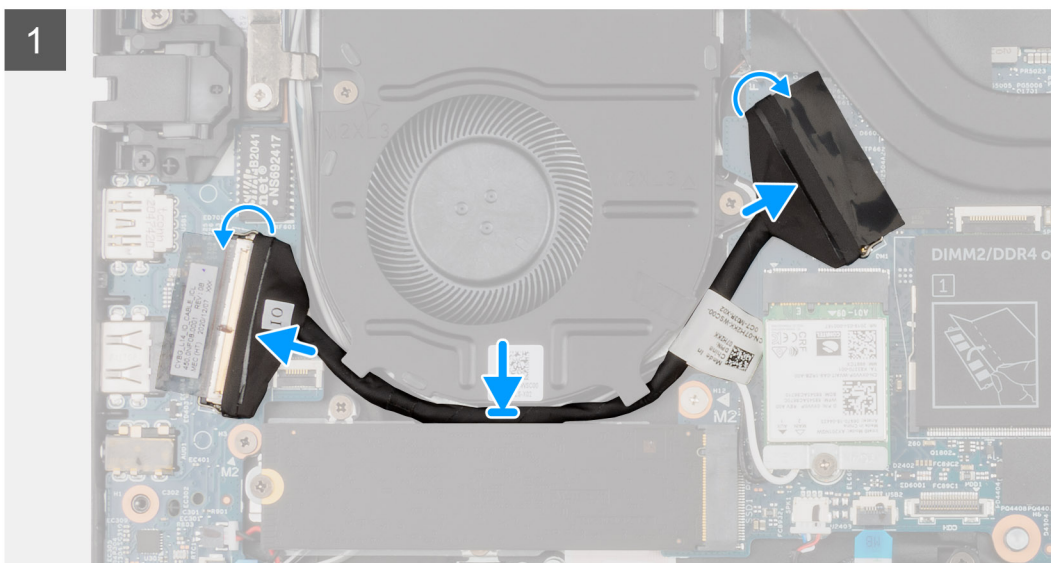
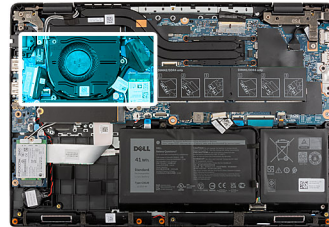

Steps

1. Route the I/O cable through the routing guides and adhere the adhesive tape to secure the I/O cable in place.
2. Connect the I/O cable to the connector on the system board, adhere the adhesive tape, and close the latch.
3. Connect the I/O cable to the connector on the I/O board, adhere the adhesive tape, and close the latch.

Next steps

1. Install the [base cover](#).
2. Exit the [service mode](#)
3. Install the [microSD-card](#).
4. Install the [SIM card tray](#) for 4G LTE enabled systems.
5. Follow the procedure in [after working inside your computer](#).

Display assembly

Removing the display assembly

Prerequisites

1. Follow the procedure in [before working inside your computer](#).

2. Remove the [microSD-card](#).
3. Remove the [SIM card tray](#) for 4G LTE enabled systems.
4. Enter the [service mode](#).
5. Remove the [base cover](#).
6. Remove the [M.2 SSD](#) for systems enabled with 4G LTE.
7. Remove the [M.2 SSD conversion bracket](#) for systems enabled with 4G LTE.
8. Remove the [M.2 SSD conversion plate](#) for systems enabled with 4G LTE.
9. Remove the [WLAN card](#).
10. Remove the [WWAN card](#) for systems enabled with 4G LTE.
11. Remove the [I/O cable](#).

About this task

The following images indicate the location of the display assembly and provide a visual representation of the removal procedure.

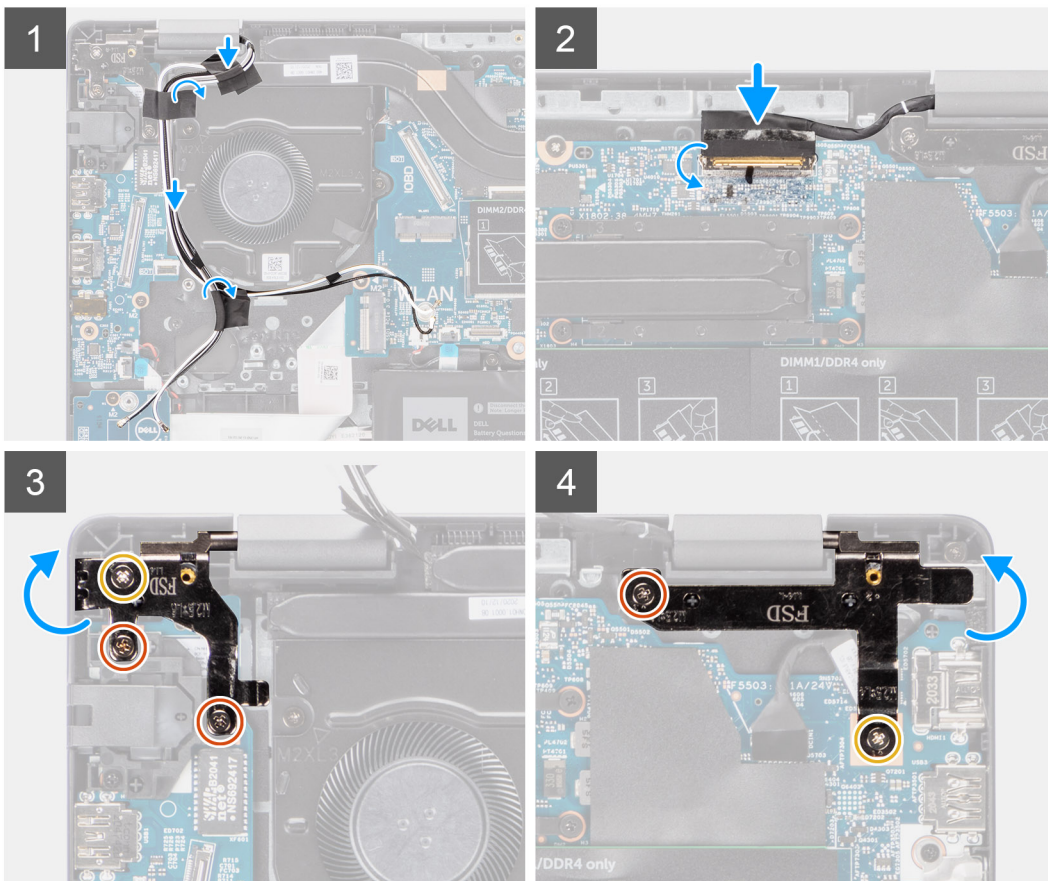
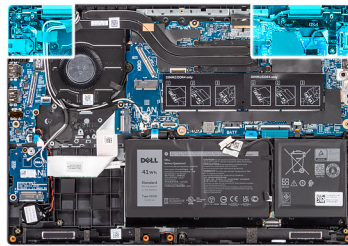
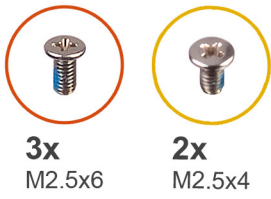

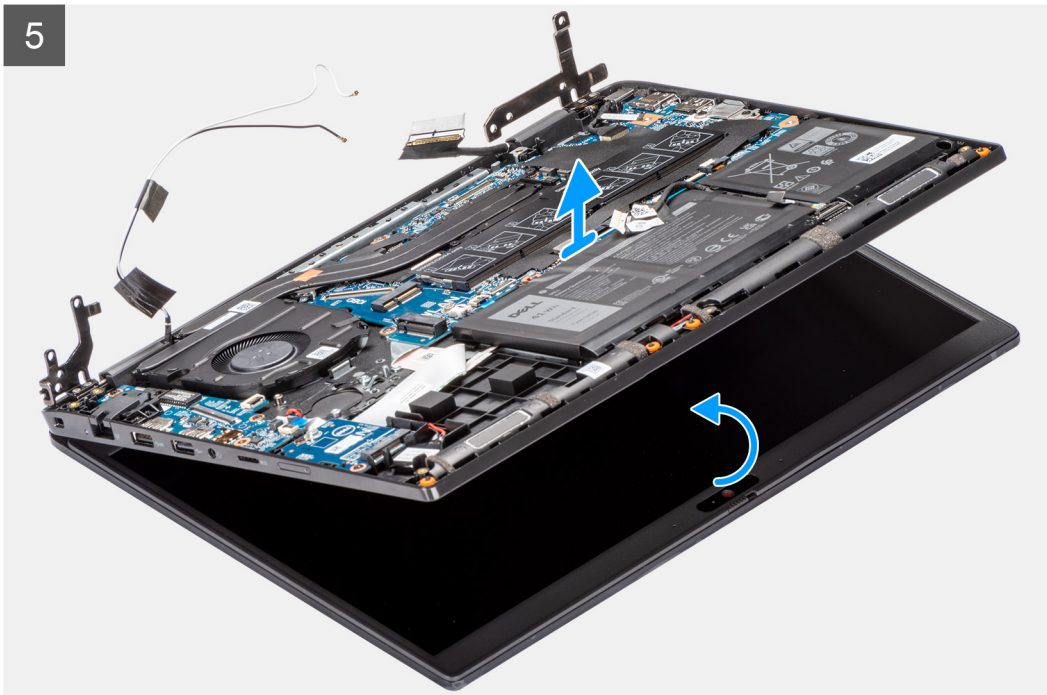

Steps

1. Unroute the display cable from the routing guides in the palmrest assembly.
2. Peel the adhesive tape that secures the display cable in place.
3. Open the latch and disconnect the display cable from the connector on the system board.
4. Remove the three (M2.5x6) and two (M2.5x4) screws that secure the display hinges to the system.
5. Lift the left and right hinges in upward direction away from the palmrest assembly.
6. Lift the palmrest assembly off the display assembly.

Installing the display assembly

Prerequisites

If you are replacing a component, remove the existing component before performing the installation procedure.

About this task

The following images indicate the location of the display assembly and provide a visual representation of the installation procedure.

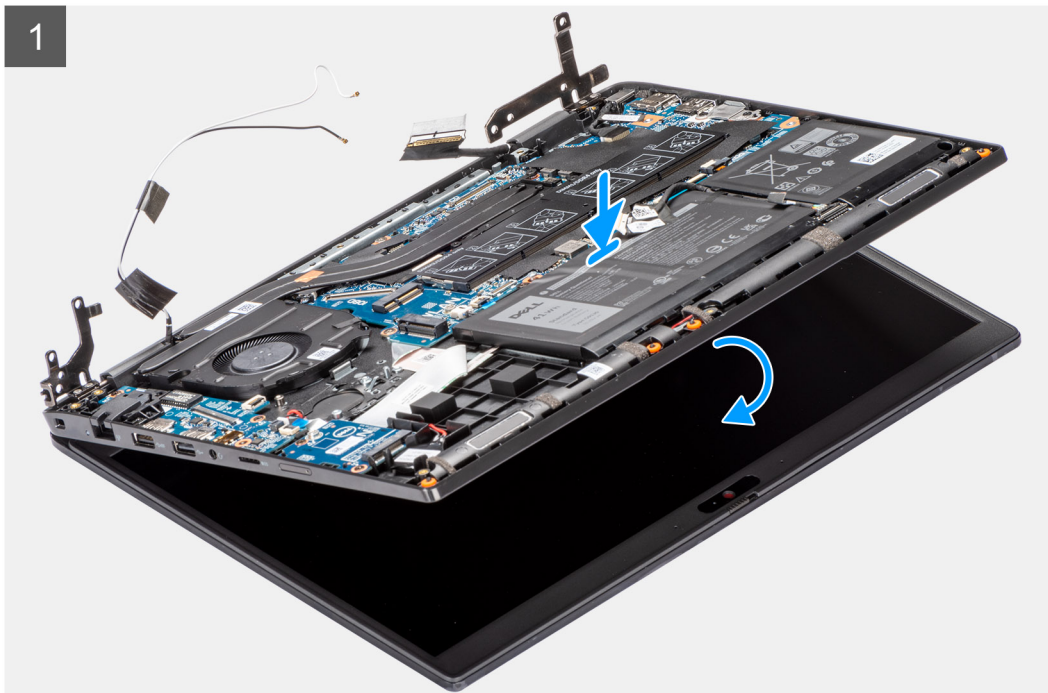

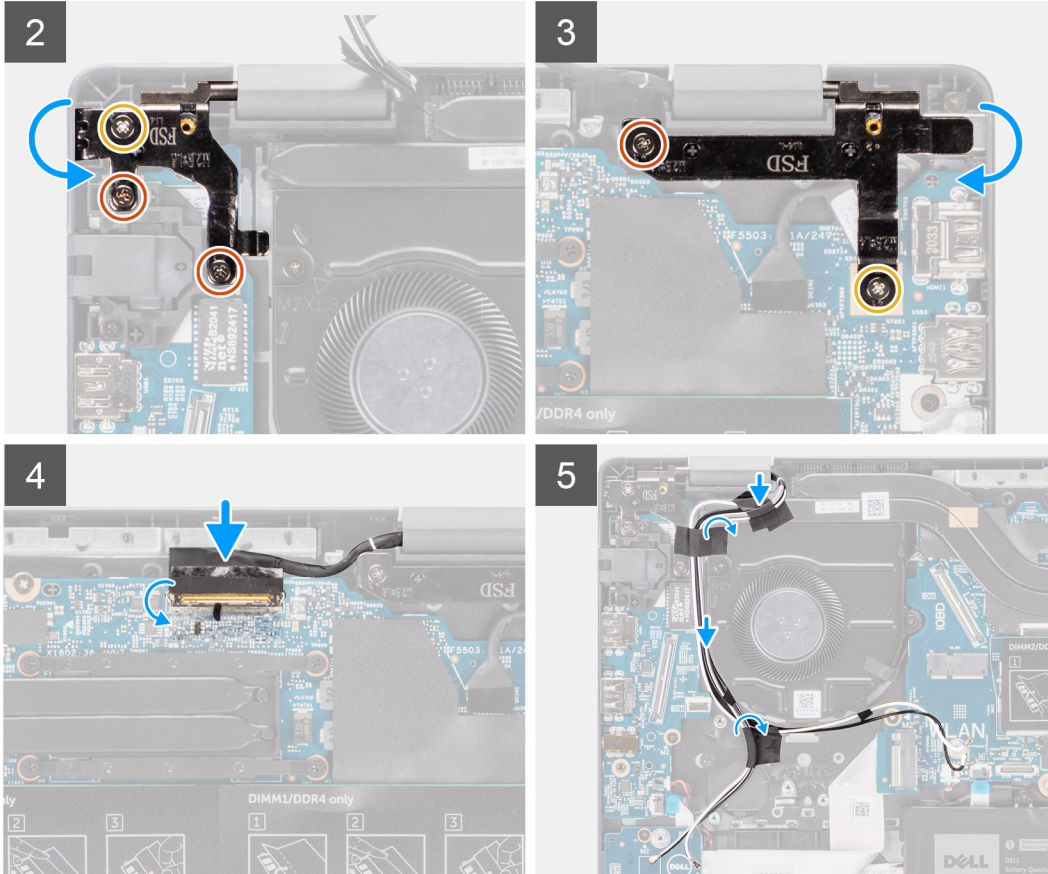
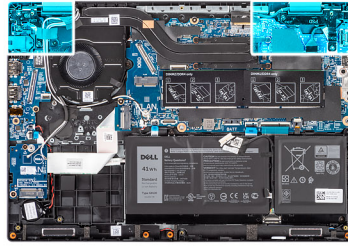

Steps

1. Align and place the system chassis under the hinges of the display assembly.
2. Press the left and right hinges in downward direction toward the palmrest assembly.
3. Install the three (M2.5x6) and two (M2.5x4) screws to secure the display hinges to the palmrest assembly.
4. Connect the display cable to the connector on the system board and close the latch.
5. Route the display cable through the routing guides in the palmrest assembly.
6. Affix the adhesive tape to secures the display cable in place.

Next steps

1. Install the [I/O cable](#).
2. Install the [WWAN card](#) for systems enabled with 4G LTE.
3. Install the [WLAN card](#).
4. Install the [M.2 SSD conversion plate](#) for systems enabled with 4G LTE.
5. Install the [M.2 SSD conversion bracket](#) for systems enabled with 4G LTE.
6. Install the [M.2 SSD](#) for systems enabled with 4G LTE.
7. Install the [base cover](#).
8. Exit the [service mode](#)
9. Install the [SIM card tray](#) for 4G LTE enabled systems.
10. Install the [microSD-card](#).

11. Follow the procedure in [after working inside your computer](#).

Display panel

Removing the display panel

Prerequisites

1. Follow the procedure in [before working inside your computer](#).
2. Enter the [service mode](#).
3. Remove the [microSD-card](#).
4. Remove the [SIM card tray](#) for 4G LTE enabled systems.
5. Remove the [base cover](#).
6. Remove the [WLAN card](#).
7. Remove the [WWAN card](#) for 4G LTE enabled systems.
8. Remove the [I/O board cable](#).
9. Remove the [display assembly](#).
10. Remove the [display bezel](#).

About this task

- NOTE:** The display panel is pre-assembled with the display brackets as a single service part. Do not pull and release the Stretch Release (SR) Tapes from the display panel and separate the brackets from the display panel.



The following images indicate the location of the display panel and provide a visual representation of the removal procedure.



6x
M2.5x2.5



2x
M2.5x3

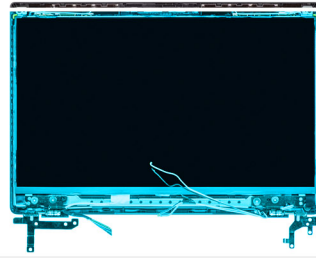

1

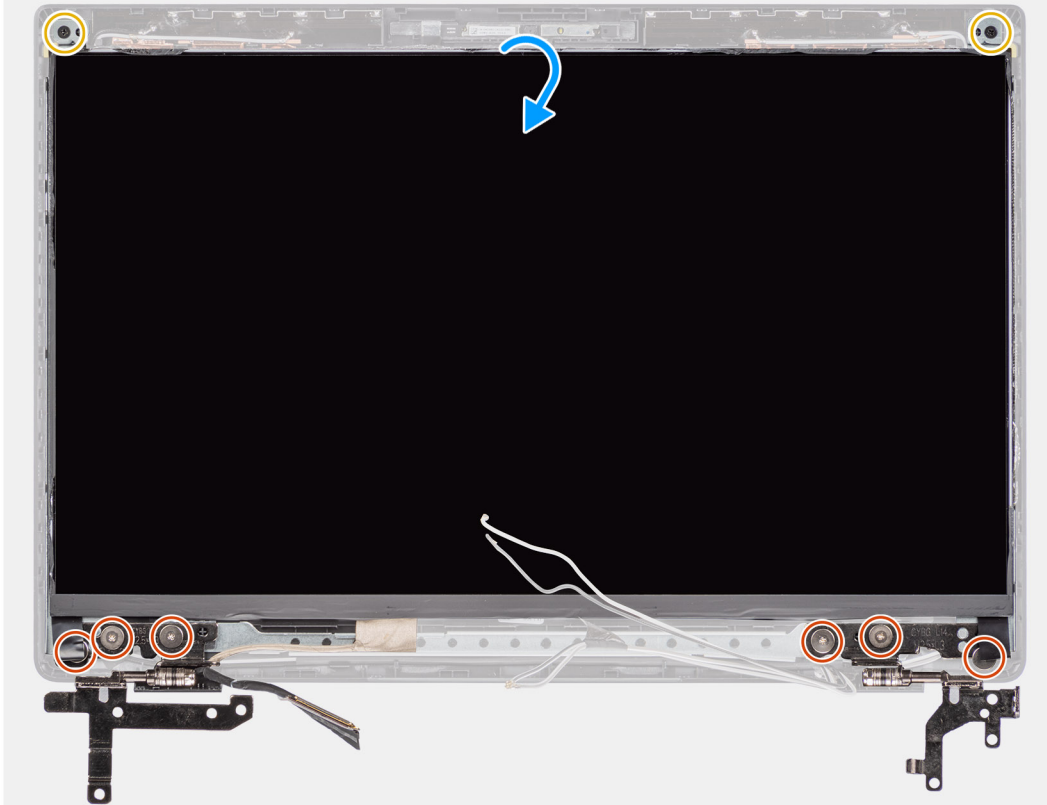

2

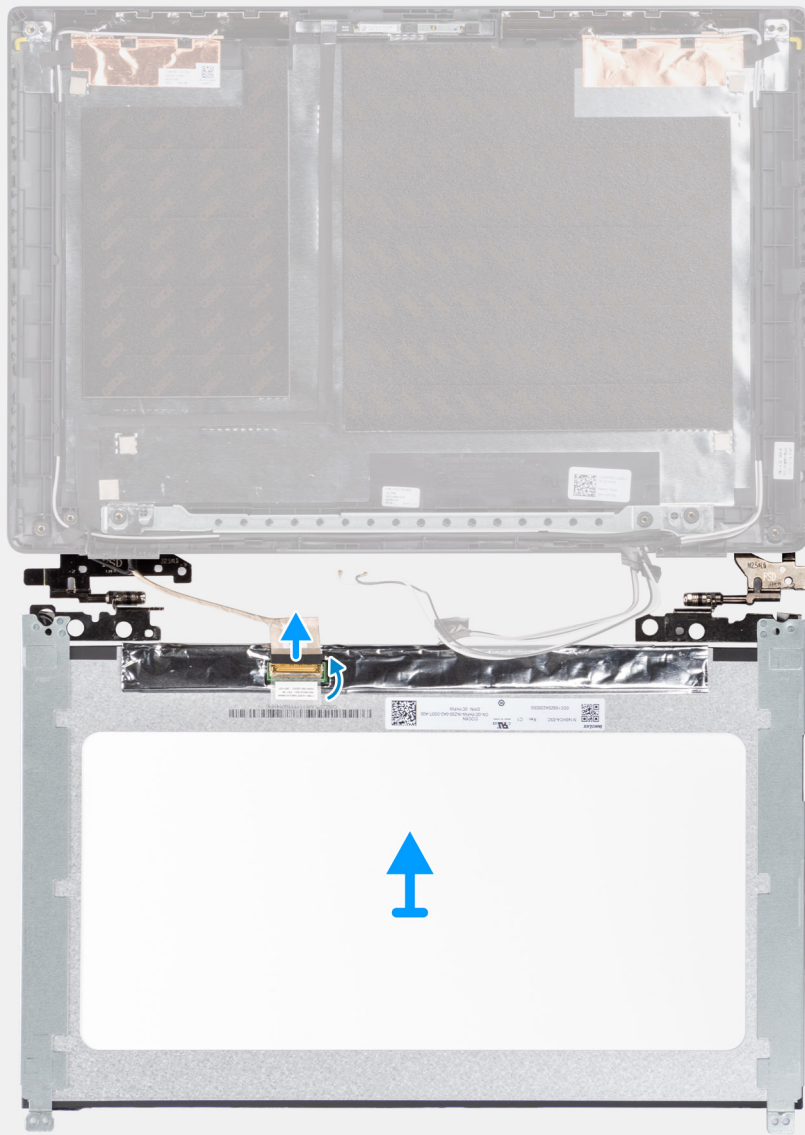



Steps

1. Remove the six (M2.5x2.5) and two (M2.5x3) screws that secure the left and right hinge brackets in place.
2. Gently flip over the display panel.
3. Peel the adhesive tape, open the latch and disconnect the display cable from the connector on the display panel.
4. Lift and remove the display panel from the display assembly.

Installing the display panel

Prerequisites

If you are replacing a component, remove the existing component before performing the installation procedure.

About this task

- NOTE:** The display panel is pre-assembled with the display brackets as a single service part. Do not pull and release the Stretch Release (SR) Tapes from the display panel and separate the brackets from the display panel.



The following images indicate the location of the display panel and provide a visual representation of the installation procedure.

1

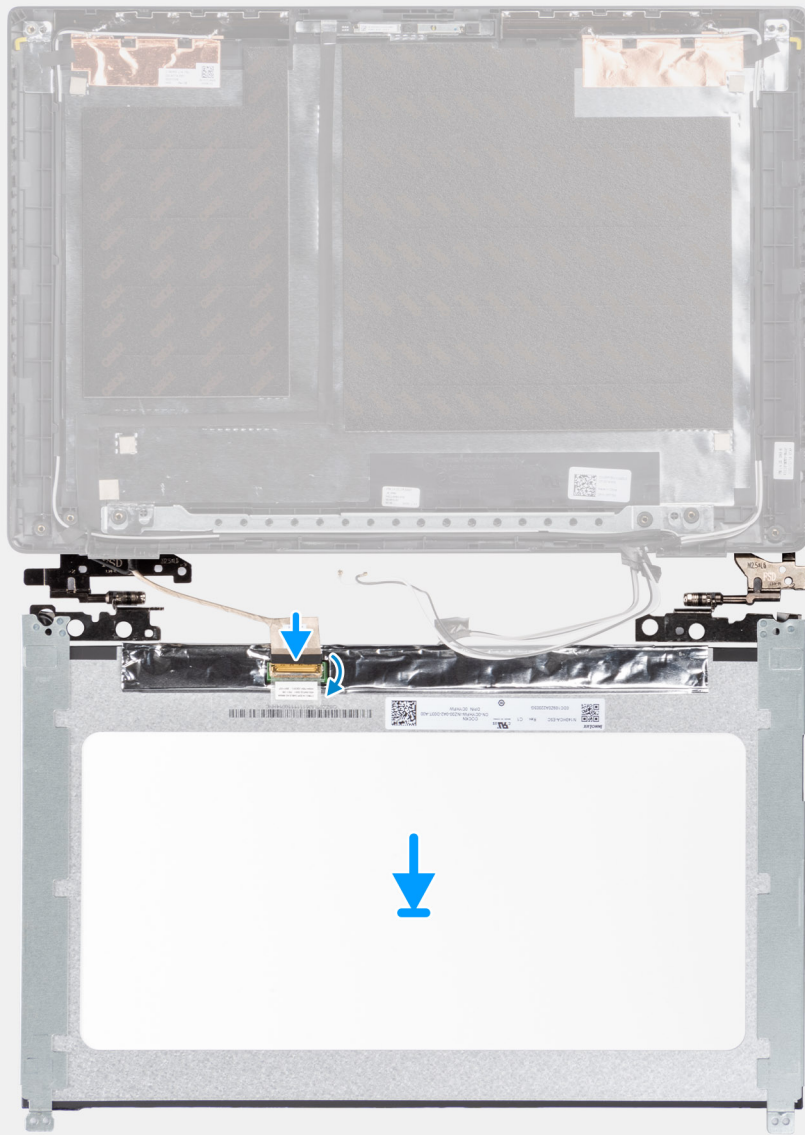

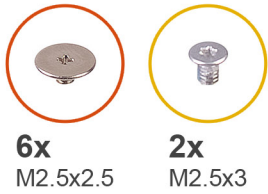

6x
M2.5x2.5

2x
M2.5x3

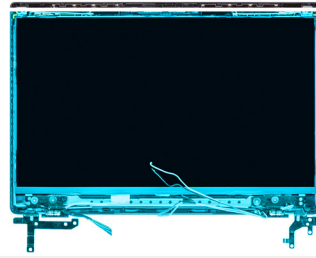

2

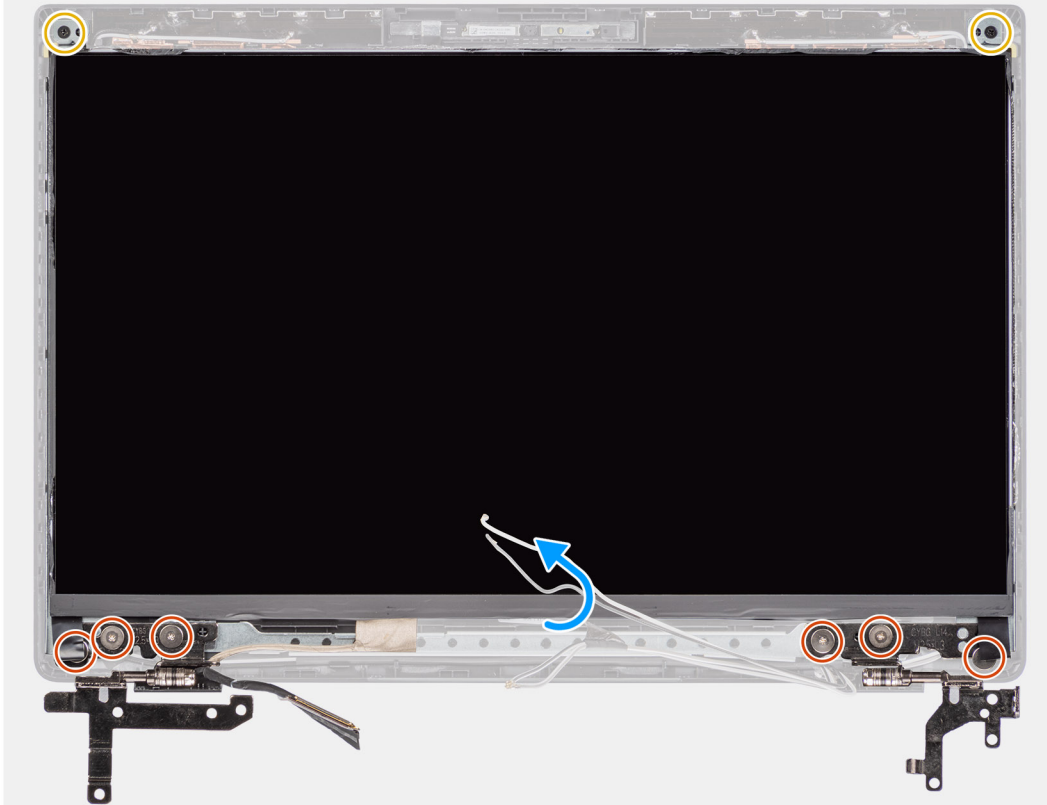

Steps

1. Align and place the display panel on the display assembly.
2. Connect the display cable to the connector on the display panel, close the latch and affix the adhesive tape.
3. Install the six (M2.5x2.5) and two (M2.5x3) screws to secure the left and right hinge brackets in place.
4. Gently flip over the display panel.

Next steps

1. Install the [display bezel](#).
2. Install the [display assembly](#).
3. Install the [I/O board cable](#).
4. Install the [WWAN card](#) for 4G LTE enabled systems..
5. Install the [WLAN card](#).
6. Install the [base cover](#).
7. Install the [SIM card tray](#) for 4G LTE enabled systems.
8. Install the [microSD-card](#).
9. Exit the [service mode](#)
10. Follow the procedure in [after working inside your computer](#).

Display bezel

Removing the display bezel

Prerequisites

1. Follow the procedure in [before working inside your computer](#).
2. Remove the [microSD-card](#).
3. Remove the [SIM card tray](#) for 4G LTE enabled systems.
4. Enter the [service mode](#).
5. Remove the [base cover](#).
6. Remove the [WLAN card](#).
7. Remove the [WWAN card](#) for 4G LTE enabled systems.
8. Remove the [I/O board cable](#).
9. Remove the [display assembly](#).

About this task

The following images indicate the location of the display bezel and provide a visual representation of the removal procedure.

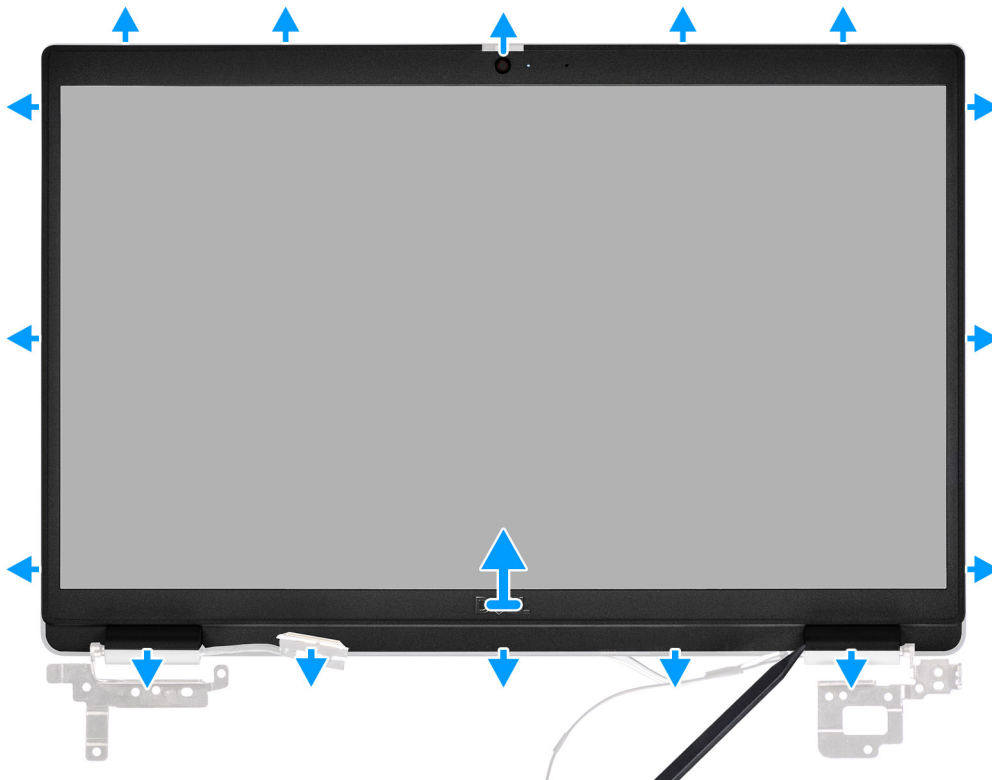

Steps

1. Use a plastic scribe to carefully pry open the top, left, and right sides of the display bezel.

CAUTION: When prying open the display bezel, ensure to pry along the outside edge of the display bezel using your hand or a plastic scribe. Using a screw driver or any sharp object may damage the display cover.

2. Lift and remove the display bezel from the display assembly.

Installing the display bezel

Prerequisites

If you are replacing a component, remove the existing component before performing the installation procedure.

About this task

The following image indicates the location of the display bezel and provides a visual representation of the installation procedure.

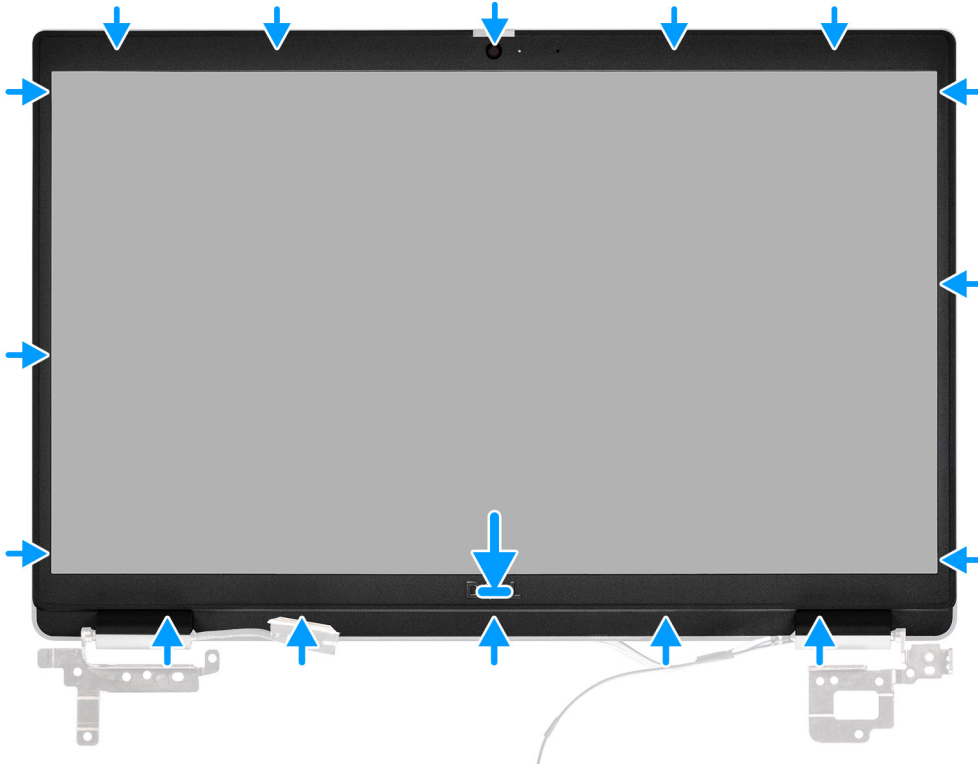

Steps

Align the display bezel with the display assembly. Gently snap the display bezel into place.

Next steps

1. Install the [display assembly](#).
2. Install the [I/O board cable](#).
3. Install the [WWAN card](#) for 4G LTE enabled systems.
4. Install the [WLAN card](#).
5. Install the [base cover](#).
6. Exit the [service mode](#)
7. Install the [SIM card tray](#) for 4G LTE enabled systems.
8. Install the [microSD-card](#).
9. Follow the procedure in [after working inside your computer](#).

Heatsink assembly

Removing the heatsink assembly

Prerequisites

1. Follow the procedure in [before working inside your computer](#).
2. Remove the [microSD-card](#).
3. Remove the [SIM card tray](#) for systems enabled with 4G LTE.
4. Enter the [service mode](#).
5. Remove the [base cover](#).

About this task

The following images indicate the location of the heatsink assembly and provide a visual representation of the removal procedure.

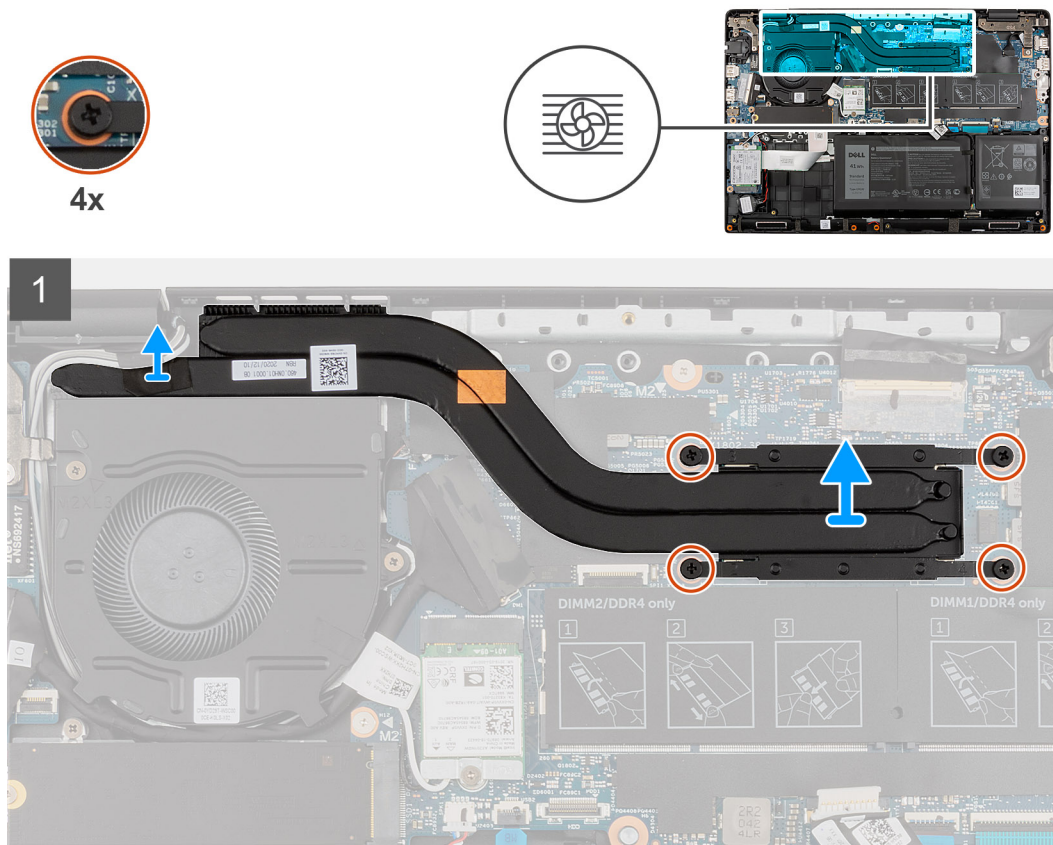

Steps

1. Loosen the four captive screws (in reverse order, 4->3->2->1) that secure the heatsink assembly to the system board.
2. Lift and remove the heatsink assembly from the system board.

Installing the heatsink assembly

Prerequisites

If you are replacing a component, remove the existing component before performing the installation procedure.

About this task

The following image indicates the location of the heatsink assembly and provides a visual representation of the installation procedure.

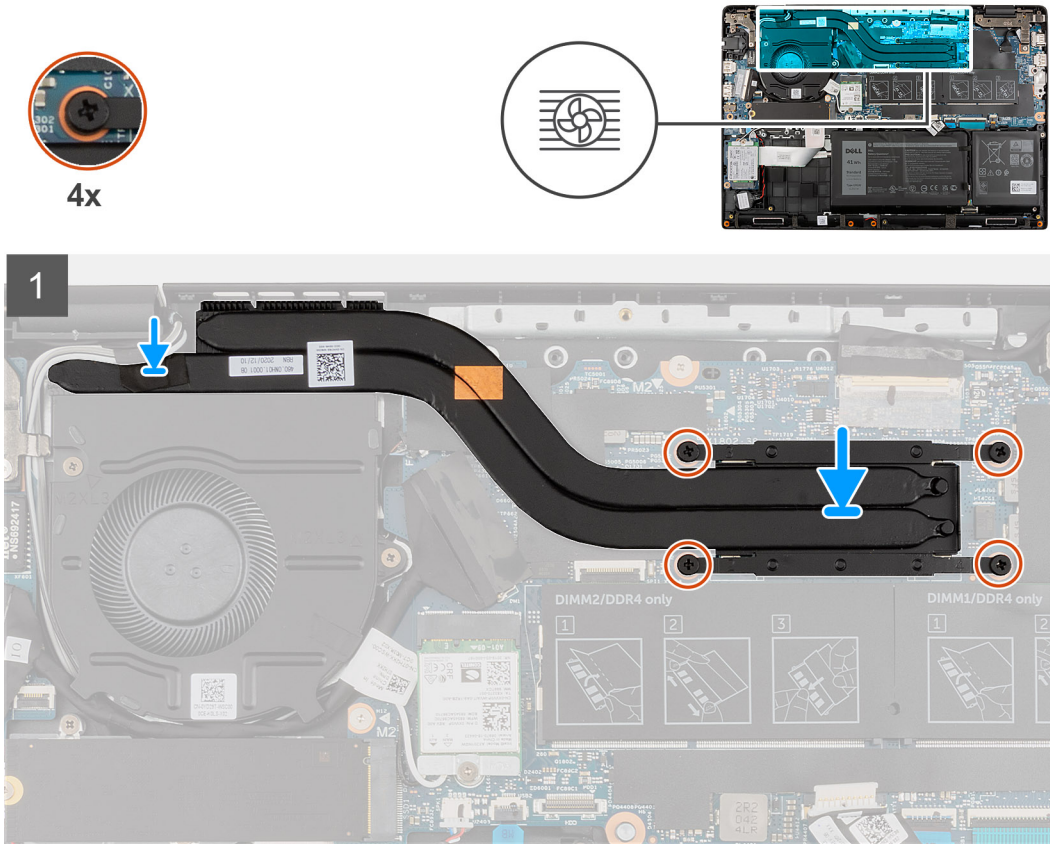

Steps

1. Align and place the heatsink assembly into the slot on the system board.
2. Tighten the four captive screws (in order, 1>2>3>4) to secure the heatsink assembly to the system board.

Next steps

1. Install the [base cover](#).
2. Exit the [service mode](#)
3. Install the [SIM card tray](#) for systems enabled with 4G LTE.
4. Install the [microSD-card](#).
5. Follow the procedure in [after working inside your computer](#).

Power adapter port

Removing the power adapter port

Prerequisites

1. Follow the procedure in [before working inside your computer](#).
2. Remove the [microSD-card](#).
3. Remove the [SIM card tray](#) for 4G LTE enabled systems.
4. Enter the [service mode](#).
5. Remove the [base cover](#).

About this task

The following image indicates the location of the power adapter port and provides a visual representation of the removal procedure.

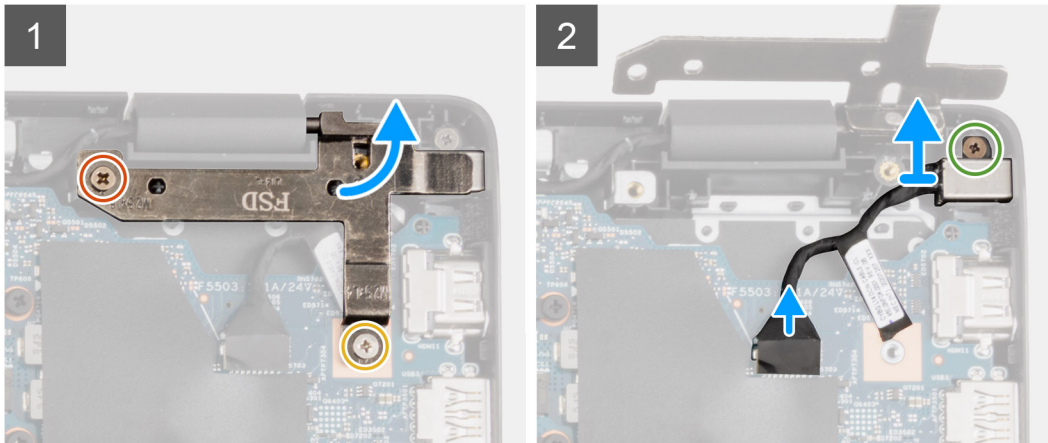
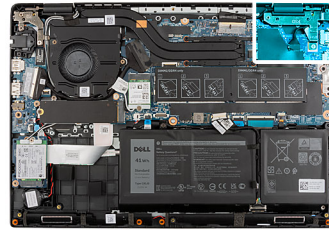

Steps

1. Remove the (M2.5x6) and (M2.5x4) screws that secure the display hinges to the system.
2. Disconnect the power adapter port from the connector on the system board.
3. Remove the (M2x3) screw that secures the power adapter port to the palmrest assembly.
4. Lift and remove the power adapter port from the palmrest assembly.

Installing the power adapter port

About this task

The following image indicates the location of the power adapter port and provides a visual representation of the removal procedure.

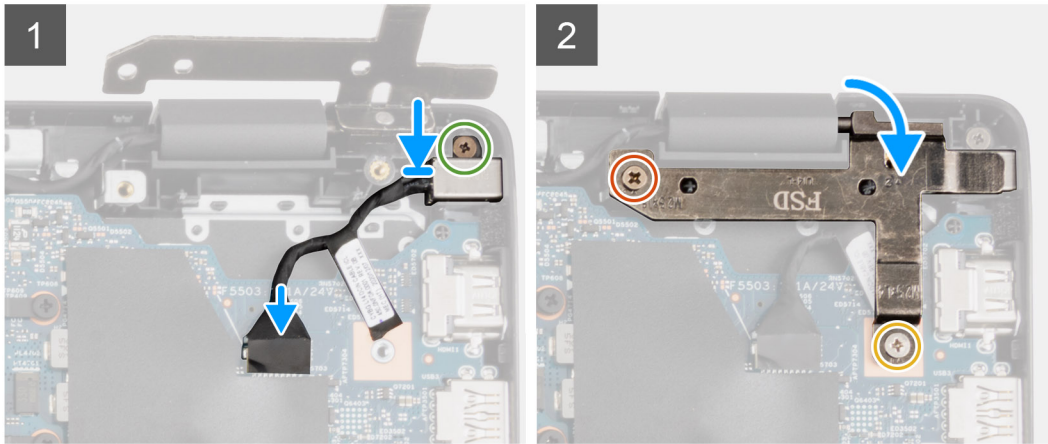
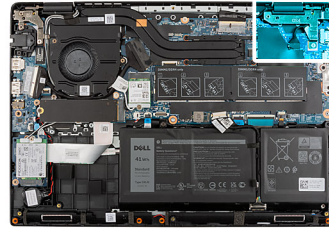

Steps

1. Align and place the power adapter port on the palmrest assembly.
2. Install the (M2x3) screw to secure the power adapter port to the palmrest assembly.
3. Connect the power adapter port to the connector on the system board.
4. Install the (M2.5x6) and (M2.5x4) screws to secure the display hinges to the system.

Next steps

1. Install the [base cover](#).
2. Exit the [service mode](#)
3. Install the [SIM card tray](#) for 4G LTE enabled systems.
4. Install the [microSD-card](#).
5. Follow the procedure in [after working inside your computer](#).

Coin-cell battery

Removing the coin-cell battery

Prerequisites

1. Follow the procedure in [before working inside your computer](#).
2. Remove the [microSD-card](#).
3. Remove the [SIM card tray](#) for 4G LTE enabled systems.
4. Enter the [service mode](#).
5. Remove the [base cover](#).
6. Remove the [hard-disk drive](#) for systems shipped with hard-disk drive.
7. Remove the [WWAN card](#) for systems enabled with 4G LTE.
8. Remove the [WWAN I/O board](#) for systems enabled with 4G LTE.

About this task

NOTE: If the CMOS battery is disconnected from system board for service, there will be a delay during system boot as the system undergoes RTC battery reset.

The following image indicates the location of the coin-cell battery and provides a visual representation of the removal procedure.

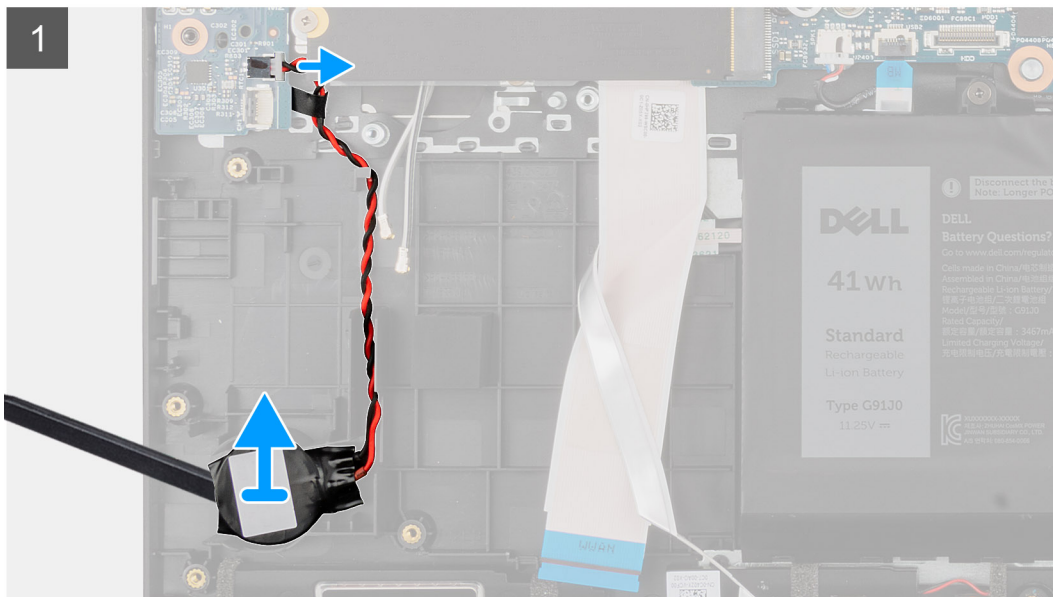
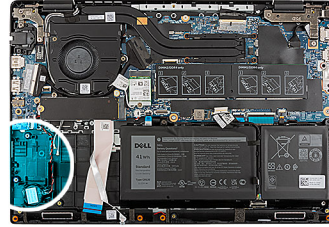

Steps

1. Disconnect the coin-cell battery cable from the connector on the I/O board.
2. Lift and remove the coin-cell battery from the palmrest assembly.

Installing the coin-cell battery

Prerequisites

If you are replacing a component, remove the existing component before performing the installation procedure.

About this task

NOTE: If the CMOS battery is disconnected from system board for service, there will be a delay during system boot as the system undergoes RTC battery reset.

The following image indicates the location of the coin-cell battery and provides a visual representation of the installation procedure.

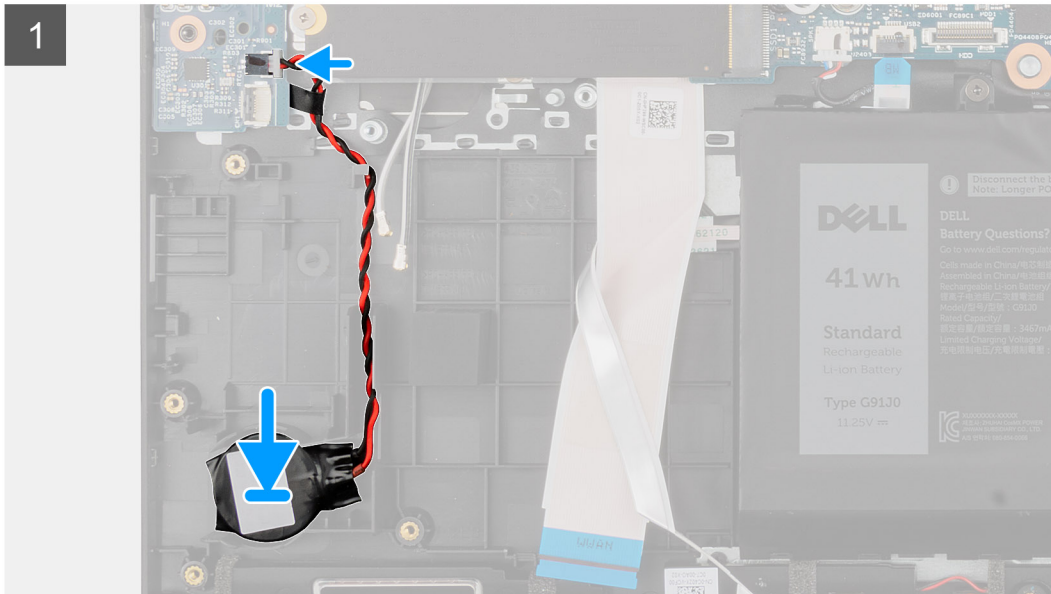
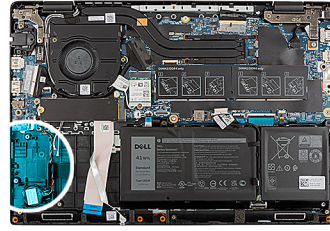

Steps

1. Align and place the coin-cell battery on the palmrest assembly.
2. Connect the coin-cell battery cable to the connector on the I/O board.

Next steps

1. Install the [WWAN I/O board](#) for systems enabled with 4G LTE.
2. Install the [WWAN card](#) for systems enabled with 4G LTE.
3. Install the [hard-disk drive](#) for systems shipped with hard-disk drive.
4. Install the [base cover](#).
5. Exit the [service mode](#)
6. Install the [SIM card tray](#) for 4G LTE enabled systems.
7. Install the [microSD-card](#).
8. Follow the procedure in [after working inside your computer](#).

USB cable

Removing the USB cable

Prerequisites

1. Follow the procedure in [before working inside your computer](#).
2. Remove the [microSD-card](#).
3. Remove the [SIM card tray](#) for 4G LTE enabled systems.
4. Remove the [base cover](#).
5. Remove the [battery](#).
6. Remove the [hard-disk drive](#).

7. Remove the [WWAN card](#) for 4G LTE enabled systems.

About this task

The following image indicates the location of the USB cable and provides a visual representation of the removal procedure.

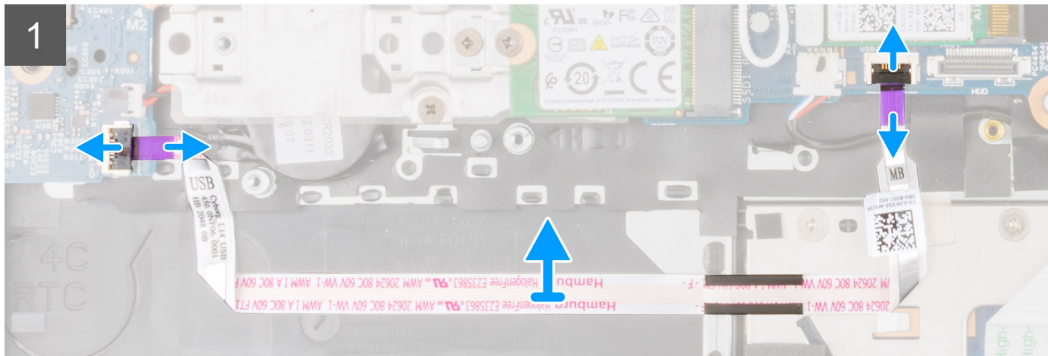
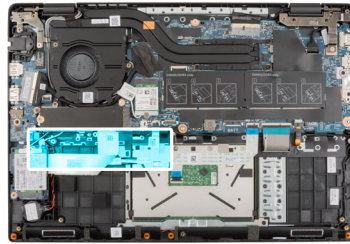

Steps

1. Open the latch and disconnect the USB cable from the connector on the system board.
2. Carefully peel the USB cable from the palmrest assembly.
3. Open the latch and disconnect the USB cable from the connector on the I/O board.
4. Lift and remove the USB cable from the palmrest assembly.

Installing the USB cable

Prerequisites

If you are replacing a component, remove the existing component before performing the installation procedure.

About this task

The following image indicates the location of the USB cable and provides a visual representation of the installation procedure.

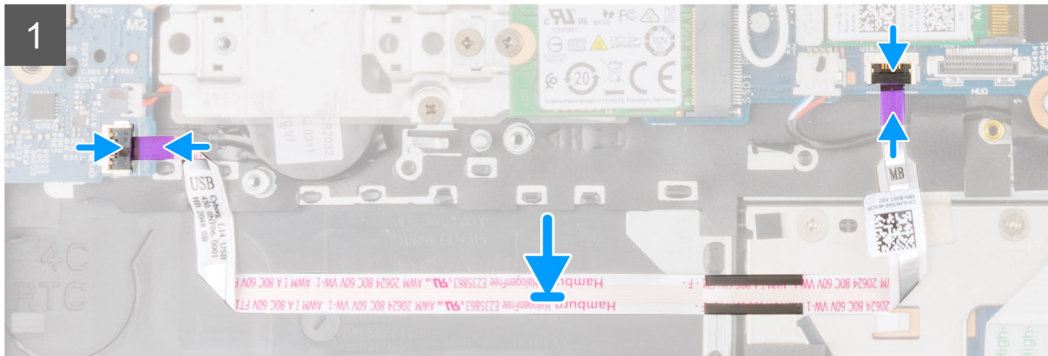
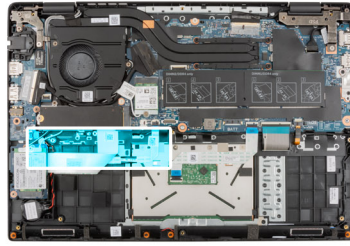

Steps

1. Connect the USB cable to the connector on the system board and close the latch.
2. Align and adhere the USB cable on the palmrest assembly.
3. Connect the USB cable to the connector on the I/O board and close the latch.

Next steps

1. Install the [WWAN card](#) for 4G LTE enabled systems.
2. Install the [hard-disk drive](#).
3. Install the [battery](#).
4. Install the [base cover](#).
5. Install the [SIM card tray](#) for 4G LTE enabled systems.
6. Install the [microSD-card](#).
7. Follow the procedure in [after working inside your computer](#).

Ethernet port

Removing the ethernet port

Prerequisites

1. Follow the procedure in [before working inside your computer](#).
2. Remove the [microSD-card](#).
3. Remove the [SIM card tray](#) for 4G LTE enabled systems.
4. Enter the [service mode](#).
5. Remove the [base cover](#).

About this task

The following image indicates the location of the ethernet port and provides a visual representation of the removal procedure.

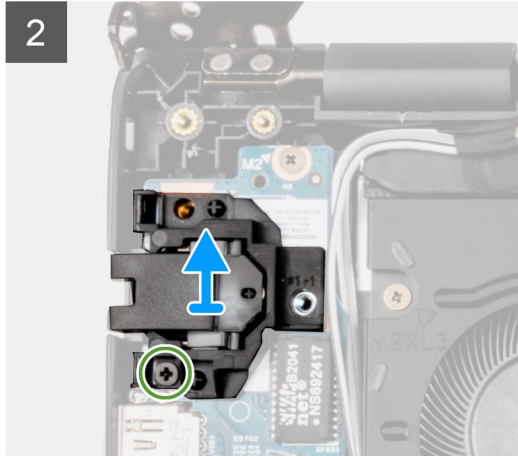
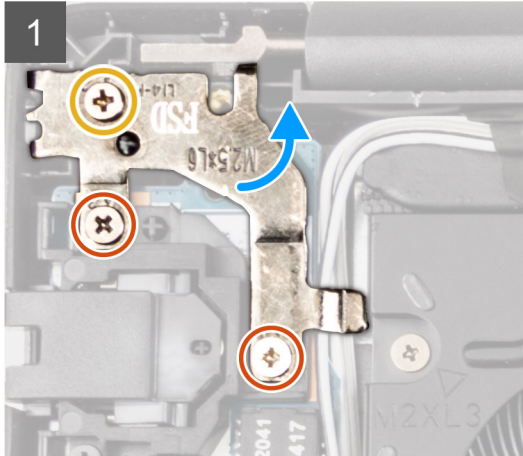
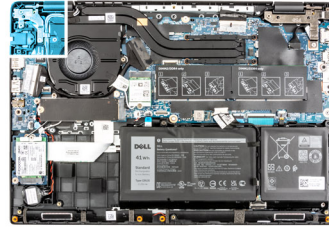

Steps

1. Remove the (M2.5x4) and two (M2.5x6) screws to secure the hinge bracket on the palmrest assembly.
2. Lift the hinge in upward direction away from the palmrest assembly.
3. Remove the (M2x5) screw that secures the ethernet on the I/O board.
4. Lift and remove the ethernet from the I/O board.

Installing the ethernet port

Prerequisites

If you are replacing a component, remove the existing component before performing the installation procedure.

About this task

The following image indicates the location of the ethernet port and provides a visual representation of the installation procedure.

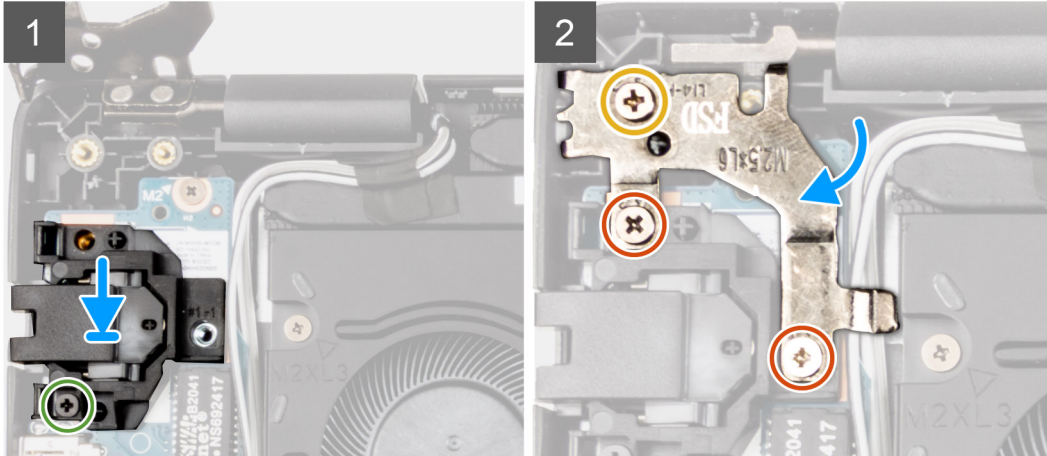
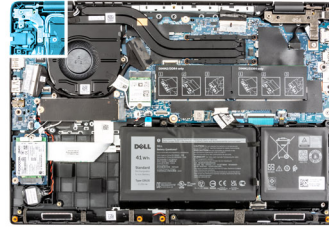

Steps

1. Align and place the ethernet on the I/O board.
2. Install the (M2x5) screw to secure the ethernet on the I/O board.
3. Press the hinge in downward direction toward the palmrest assembly.
4. Install the (M2.5x4) and two (M2.5x6) screws to secure the hinge bracket on the palmrest assembly.

Next steps

1. Install the [base cover](#).
2. Exit the [service mode](#)
3. Install the [SIM card tray](#) for 4G LTE enabled systems.
4. Install the [microSD-card](#).
5. Follow the procedure in [after working inside your computer](#).

I/O board

Removing the I/O board

Prerequisites

1. Follow the procedure in [before working inside your computer](#).
2. Remove the [microSD-card](#).
3. Remove the [SIM card tray](#) for 4G LTE enabled systems.
4. Enter the [service mode](#).
5. Remove the [base cover](#).
6. Remove the [ethernet port](#).

About this task



i **NOTE:** The following image is from systems without power-button board.

The following image indicates the location of the I/O board and provides a visual representation of the removal procedure.



2x
M2x3

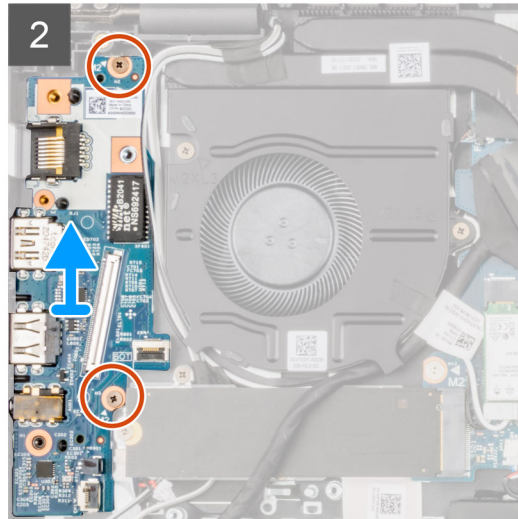
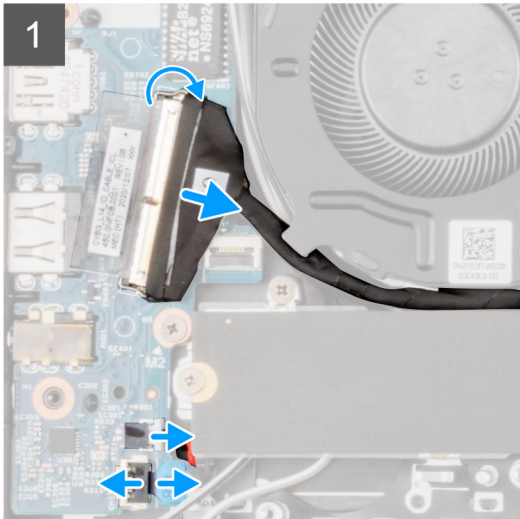
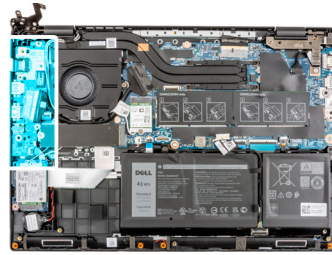

Steps

1. For systems shipped with power button, peel the adhesive, open the latch and disconnect the power button cable from the connector on the I/O board.
2. Open the latch and disconnect the I/O cable from the connector on the system board.
3. Disconnect the USB cable and coin-cell cable from the connectors on the system board.
4. Remove the two (M2x3) screws that secure the I/O board on the palmrest assembly.
5. Lift and remove the I/O board from the palmrest assembly.

Installing the I/O board

Prerequisites

If you are replacing a component, remove the existing component before performing the installation procedure.

About this task

i **NOTE:**

i **NOTE:** The following image is from systems without power button.

The following image indicates the location of the I/O board and provides a visual representation of the installation procedure.



2x
M2x3

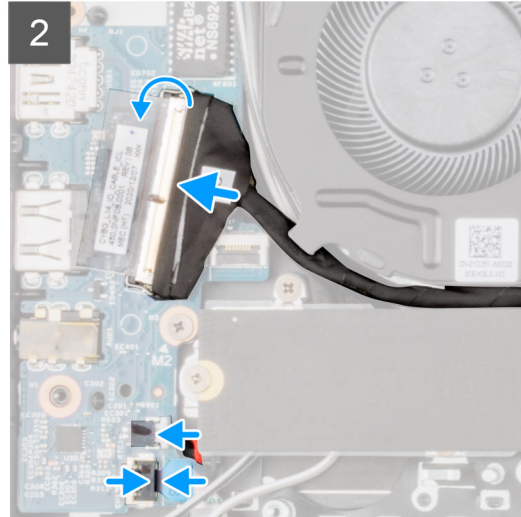
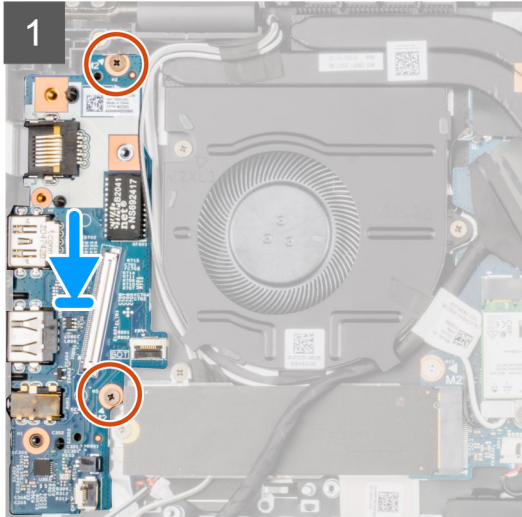
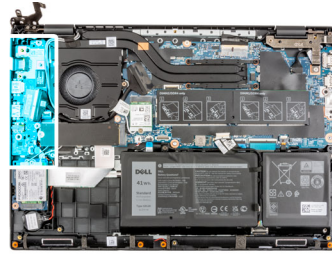

Steps

1. Align and place the I/O board into its slot on the palmrest assembly.
2. Install the two (M2x3) screws that secure the I/O board on the palmrest assembly.
3. Connect the USB cable and coin-cell cable to the connectors on the system board.
4. Connect the I/O cable to the connector on the system board and close the latch.
5. For systems shipped with power button, connect the power button cable to the connector on the I/O board, close the latch and affix the adhesive tape.

Next steps

1. Install the [ethernet port](#).
2. Install the [base cover](#).
3. Exit the [service mode](#)
4. Install the [SIM card tray](#) for 4G LTE enabled systems.
5. Install the [microSD-card](#).
6. Follow the procedure in [after working inside your computer](#).

Power button

Removing the power button without fingerprint reader

Prerequisites

1. Follow the procedure in [before working inside your computer](#).
2. Remove the [microSD-card](#).
3. Remove the [SIM card tray](#) for 4G LTE enabled systems.
4. Enter the [service mode](#).
5. Remove the [base cover](#).
6. Remove the [I/O board](#).

7. Remove the [ethernet port](#).

About this task

The following image indicates the location of the power button without fingerprint reader and provides a visual representation of the removal procedure.

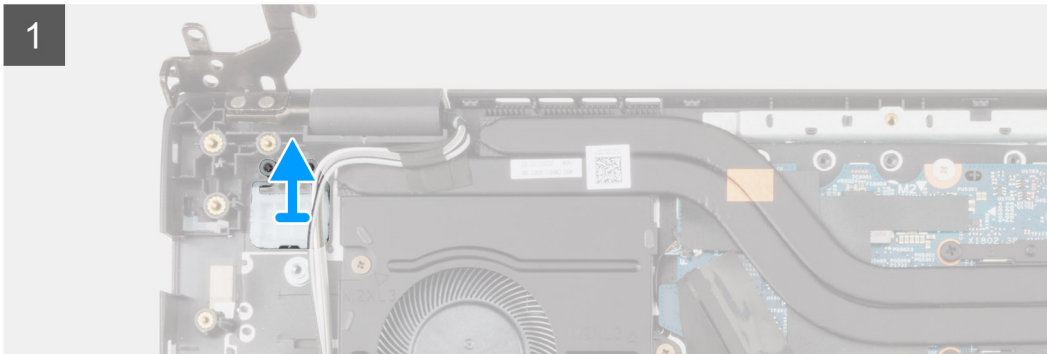
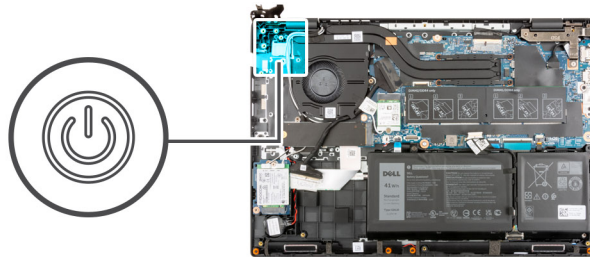

Steps

Lift the power button off the palmrest assembly.

Installing the power button without fingerprint reader

About this task

The following image indicates the location of the power button without fingerprint reader and provides a visual representation of the removal procedure.

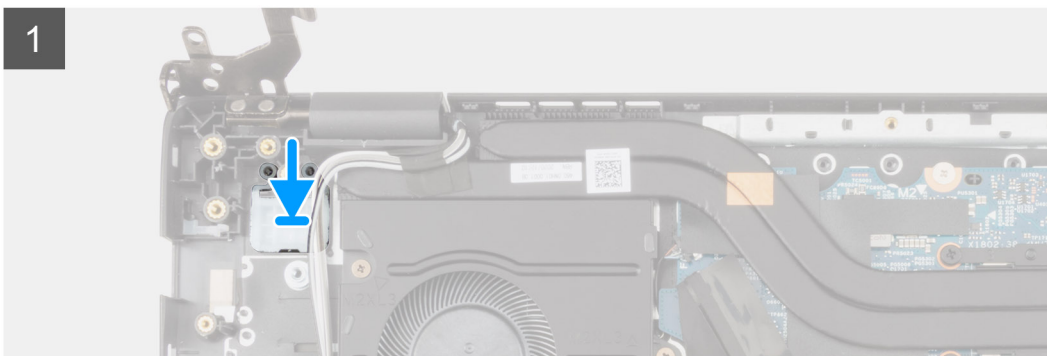
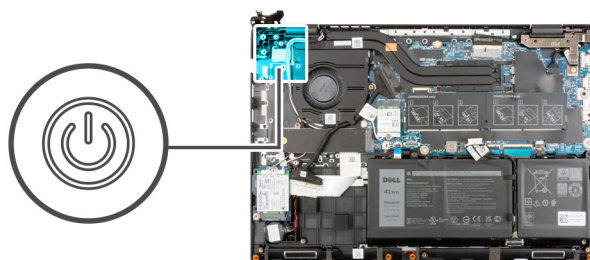

Steps

Align and place the power button into the slot on the palmrest assembly.

Next steps

1. Install the [ethernet port](#).
2. Install the [I/O board](#).
3. Install the [base cover](#).
4. Exit the [service mode](#)
5. Install the [SIM card tray](#) for 4G LTE enabled systems.
6. Install the [microSD-card](#).
7. Follow the procedure in [after working inside your computer](#).

Removing the power button with fingerprint reader

Prerequisites

1. Follow the procedure in [before working inside your computer](#).
2. Remove the [microSD-card](#).
3. Remove the [SIM card tray](#) for 4G LTE enabled systems.
4. Enter the [service mode](#).
5. Remove the [base cover](#).
6. Remove the [I/O board](#).
7. Remove the [ethernet port](#).

About this task

The following image indicates the location of the power button with fingerprint reader and provides a visual representation of the removal procedure.

NOTE:

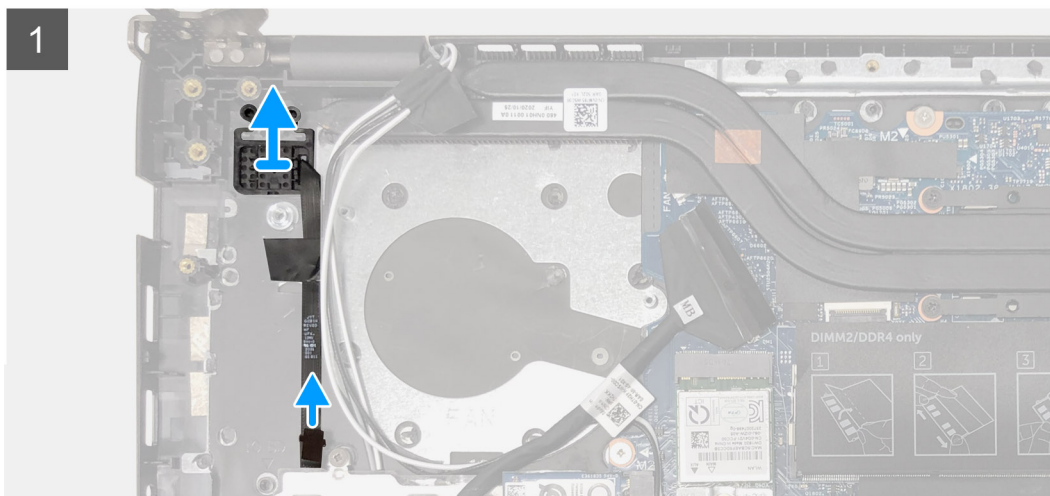
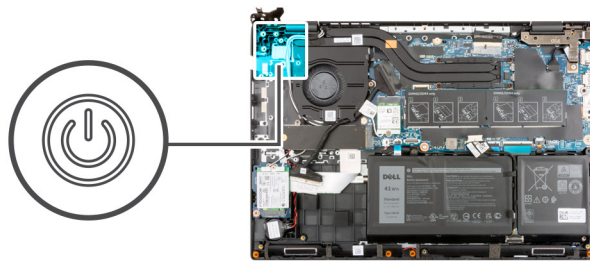

Steps

1. Peel the power button cable with adhesive backing from the palmrest assembly.
2. Lift the power button with fingerprint reader off the palmrest assembly.

Installing the power button with fingerprint reader

About this task

The following image indicates the location of the power button with fingerprint reader and provides a visual representation of the removal procedure.

NOTE:

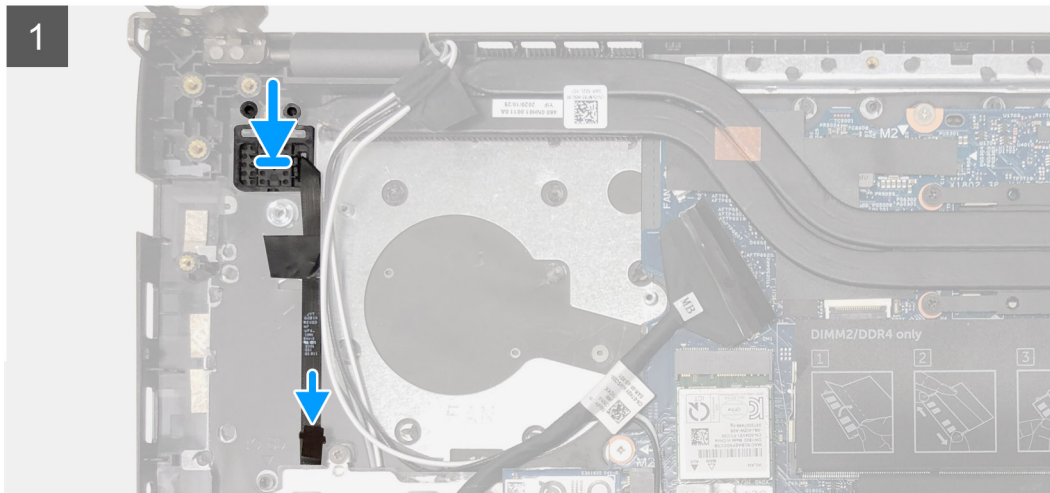
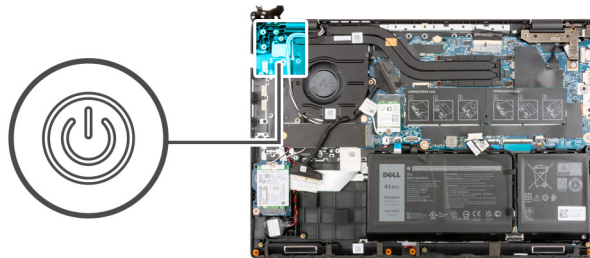

Steps

1. Affix the power button cable with adhesive backing.
2. Align and place the power button with fingerprint reader into the slot on the palmrest assembly.

Next steps

1. Install the [ethernet port](#).
2. Install the [I/O board](#).
3. Install the [base cover](#).
4. Exit the [service mode](#)
5. Install the [SIM card tray](#) for 4G LTE enabled systems.
6. Install the [microSD-card](#).
7. Follow the procedure in [after working inside your computer](#).

System board

Removing the system board

Prerequisites

1. Follow the procedure in [before working inside your computer](#).
2. Remove the [microSD-card](#).
3. Remove the [SIM card tray](#) for 4G LTE enabled systems.
4. Remove the [base cover](#).
5. Remove the [battery](#).
6. Remove the [memory module](#).
7. Remove the [M.2 SSD](#).
8. Remove the [hard-disk drive](#) for systems shipped with hard-disk drive.
9. Remove the [WLAN card](#).
10. Remove the [heatsink assembly](#).

About this task

System board connectors

 **NOTE:** The location of the memory module may vary depending on your system.

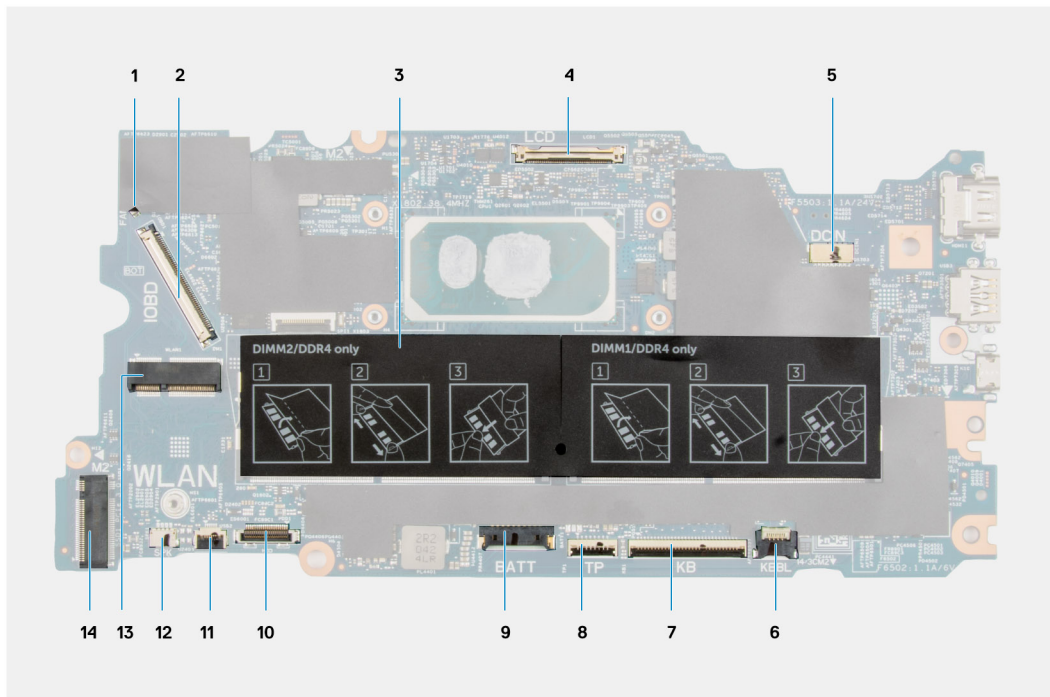

- | | |
|---------------------------------|---|
| 1. System fan cable connector | 2. I/O cable connector |
| 3. Memory module connector | 4. Display cable connector |
| 5. Power adapter port connector | 6. Keyboard backlit LED cable connector |
| 7. Keyboard cable connector | 8. Touchpad cable connector |
| 9. Battery cable connector | 10. Hard-disk drive cable connector |
| 11. USB cable connector | 12. Speaker cable connector |
| 13. WLAN card connector | 14. M.2 SSD connector |

The following images indicate the location of the system board and provide a visual representation of the removal procedure.

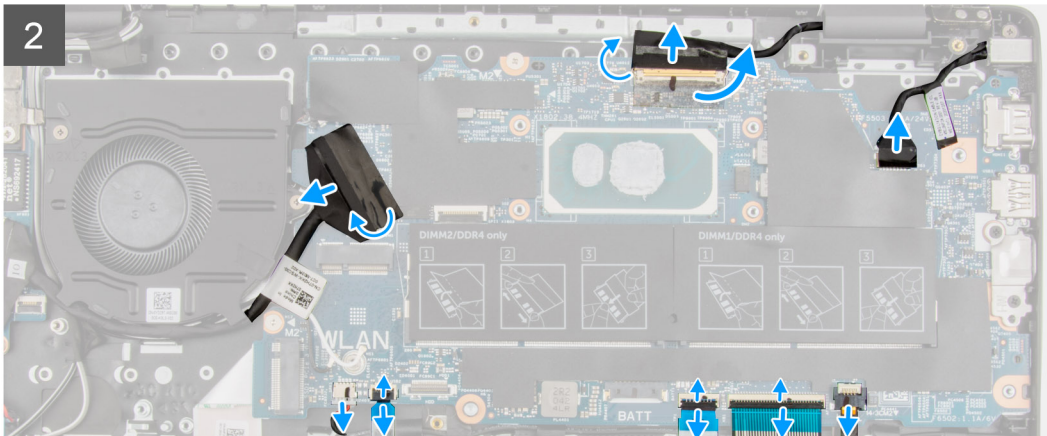
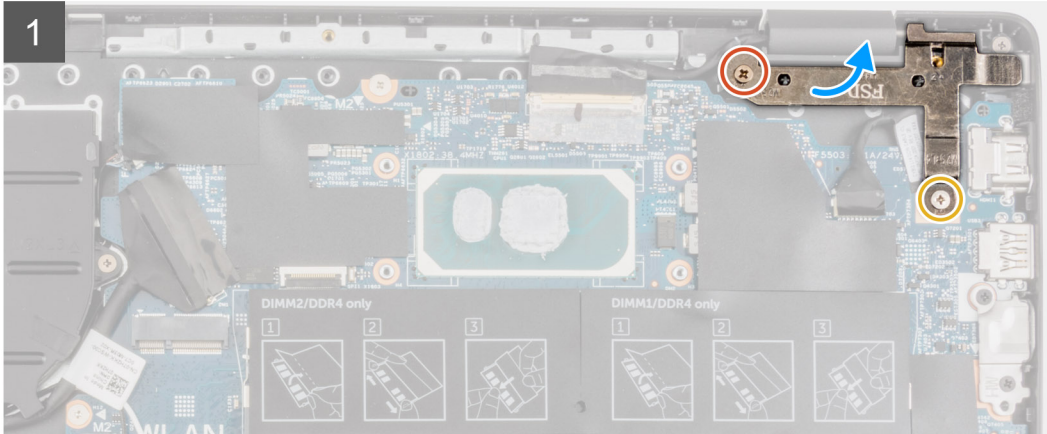
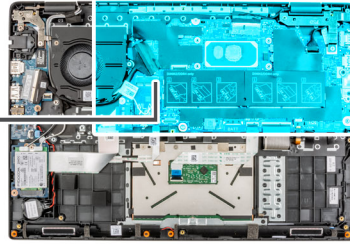
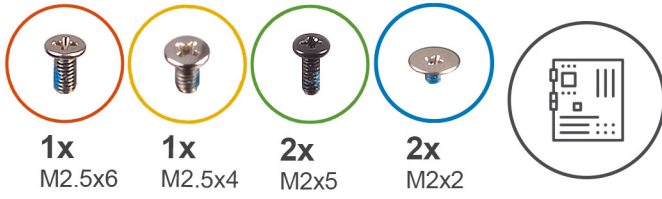

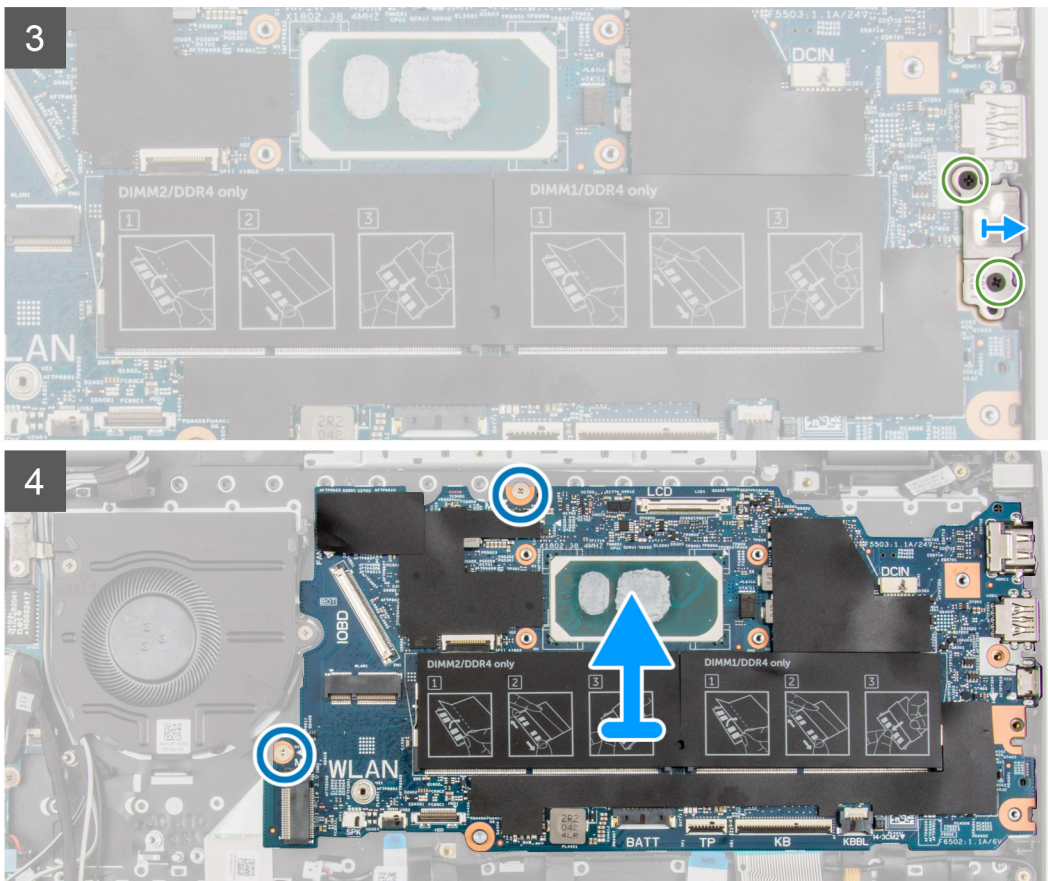

Steps

1. Remove the (M2.5x6) and the (M2.5x4) screws that secure the hinge to the palmrest assembly.
2. Lift the hinge in upward direction away from the palmrest assembly.
3. For 4G LTE enabled systems, peel the WWAN I/O board cable from the palmrest assembly.
4. Disconnect the speaker cable, power adapter port cable, hard-disk drive cable, and system fan cable from the connector on the system board.
5. Open the latch and disconnect the touchpad cable, keyboard cable, and USB cable from the connector on the system board.
6. Peel the adhesive, open the latch, and disconnect the display cable and I/O cable from the connector on the system board.
7. Remove the two (M2x5) screws that secure the type-c bracket in place.
8. Lift and remove the type-c bracket from the system board.
9. Remove the two (M2x2) screws that secure the system board in place.
10. Lift and remove the system board from the palmrest assembly.

Installing the system board

Prerequisites

If you are replacing a component, remove the existing component before performing the installation procedure.

About this task

System board connectors

NOTE: The location of the memory module may vary depending on your system.

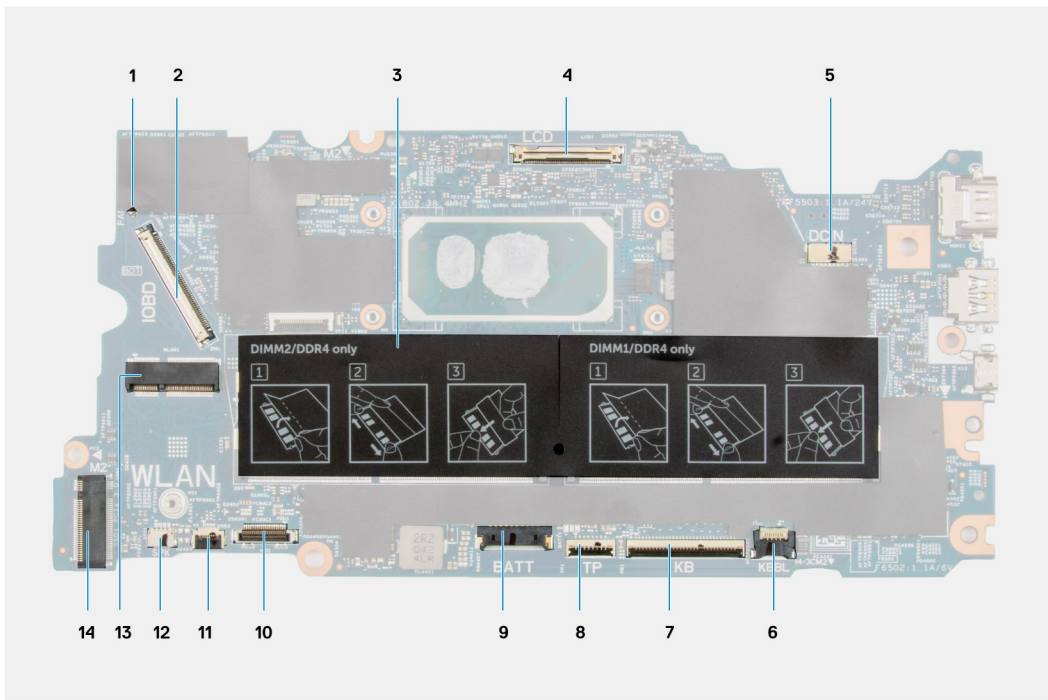

- | | |
|---------------------------------|---|
| 1. System fan cable connector | 2. I/O cable connector |
| 3. Memory module connector | 4. Display cable connector |
| 5. Power adapter port connector | 6. Keyboard backlit LED cable connector |
| 7. Keyboard cable connector | 8. Touchpad cable connector |
| 9. Battery cable connector | 10. Hard-disk drive cable connector |
| 11. USB cable connector | 12. Speaker cable connector |
| 13. WLAN card connector | 14. M.2 SSD connector |

The following images indicate the location of the system board and provide a visual representation of the installation procedure.

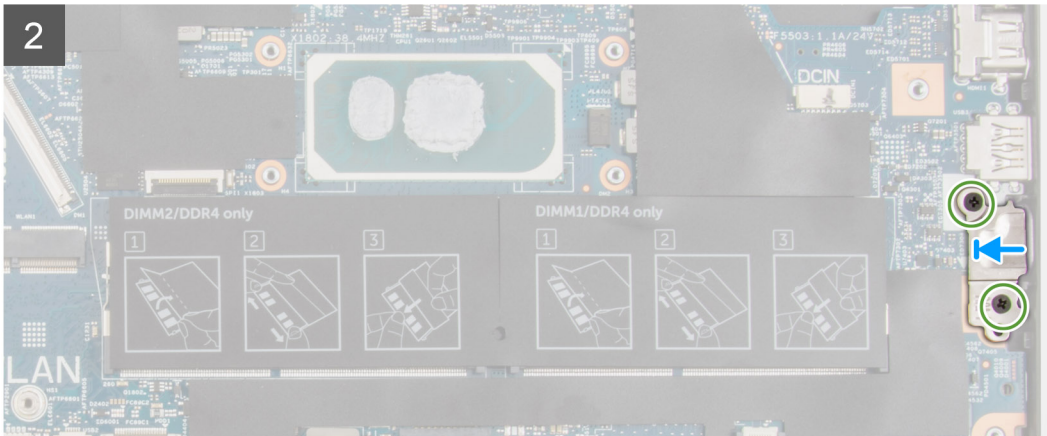
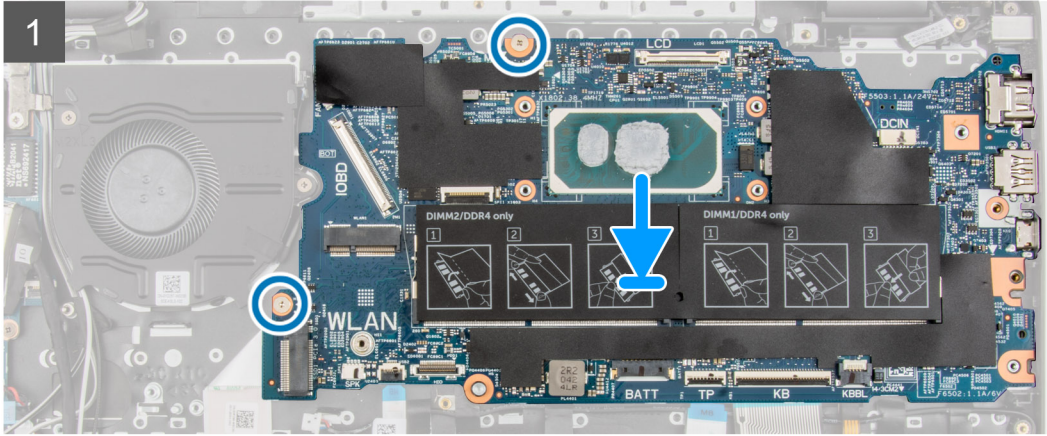
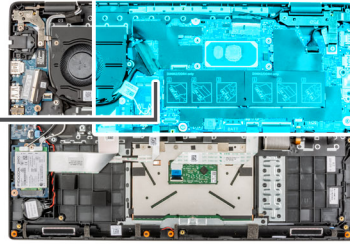
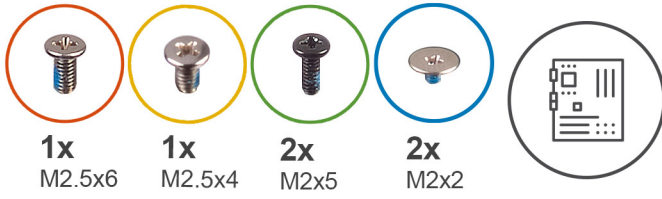

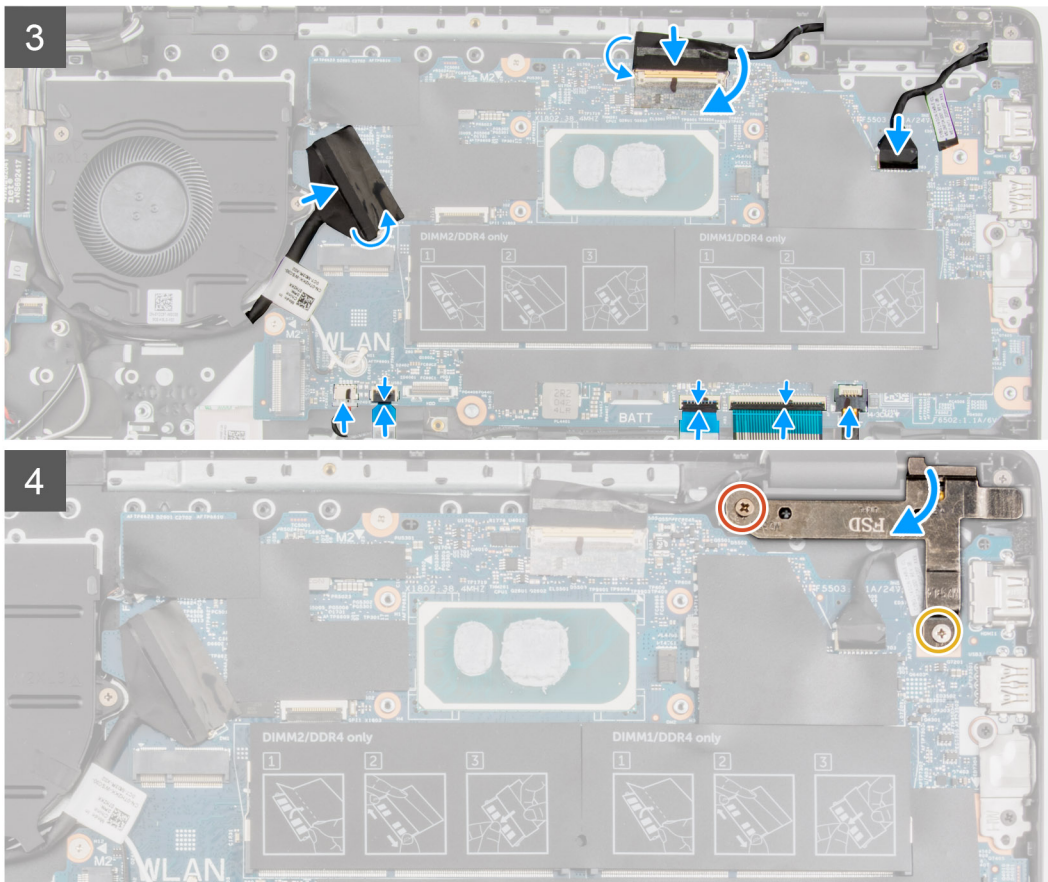

Steps

1. Align and place the system board into the slot on the palmrest assembly.
2. Install the two (M2x2) screws to secure the system board in place.
3. Align and place the type-c bracket on the system board.
4. Install the two (M2x5) screws to secure the type-c bracket in place.
5. Connect the display cable and I/O cable to the connector on the system board, close the latches and affix the adhesive tapes.
6. Connect the touchpad cable, keyboard cable, and USB cable to the connector on the system board and close the latches.
7. Connect the speaker cable, power adapter port cable, hard-disk drive cable, and system fan cable to the connector on the system board.
8. For 4G LTE enabled systems, affix the WWAN I/O board cable on the palmrest assembly.
9. Press the hinge in downward direction toward the palmrest assembly.
10. Install the (M2.5x6) and the (M2.5x4) screws to secure the hinge to the palmrest assembly.

Next steps

1. Install the [heatsink assembly](#).
2. Install the [WLAN card](#).
3. Install the [hard-disk drive](#) for systems shipped with hard-disk drive.
4. Install the [M.2 SSD](#).
5. Install the [memory module](#).
6. Install the [battery](#).
7. Install the [base cover](#).
8. Install the [SIM card tray](#) for 4G LTE enabled systems.
9. Install the [microSD-card](#).
10. Follow the procedure in [after working inside your computer](#).

Speakers

Removing the speaker

Prerequisites

1. Follow the procedure in [before working inside your computer](#).
2. Remove the [microSD-card](#).
3. Remove the [SIM card tray](#) for 4G LTE enabled systems.
4. Remove the [base cover](#).
5. Remove the [battery](#).

About this task

The following image indicates the location of the speakers and provides a visual representation of the removal procedure.

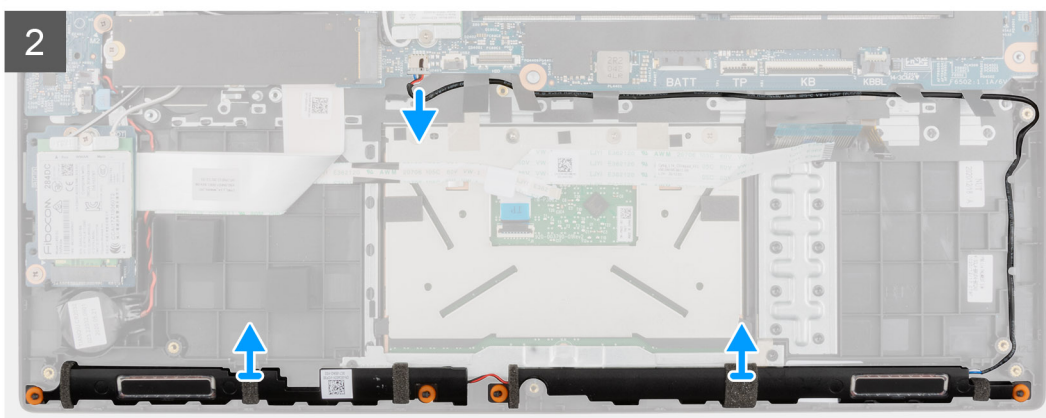
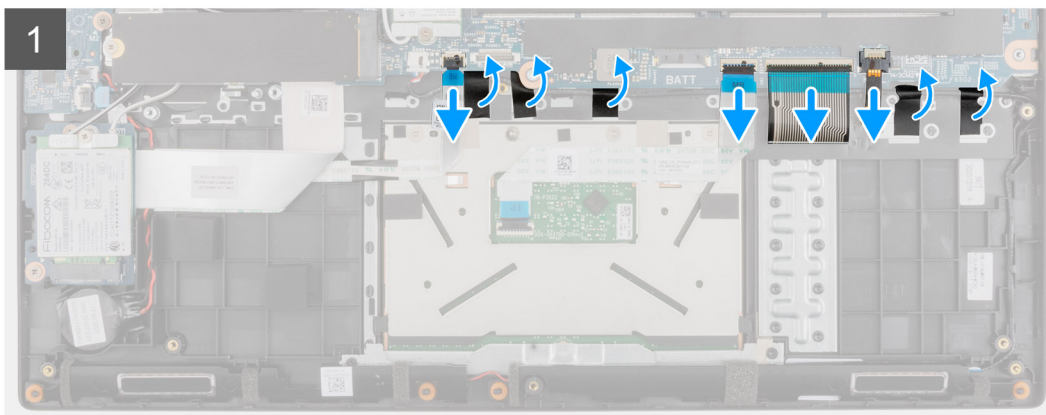
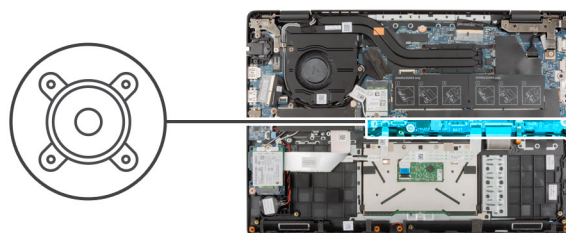

Steps

1. Disconnect the hard-disk drive cable from the connector on the system board.
2. Open the latch and disconnect the touchpad cable, keyboard cable, keyboard backlit LED cable, and USB cable from the connectors on the system board.
3. Disconnect the speaker cable from the connector on the system board.

4. Unroute the speaker cable from the routing guides in the palmrest assembly.
5. Peel the adhesive tapes, lift and remove the speakers off the palmrest assembly.

Installing the speaker

Prerequisites

If you are replacing a component, remove the existing component before performing the installation procedure.

About this task

The following image indicates the location of the speakers and provides a visual representation of the installation procedure.

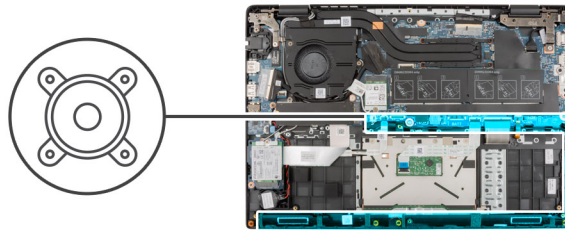

Steps

1. Align and place the speakers into the slot on the palmrest assembly.
2. Route the speaker cable through the routing guides in the palmrest assembly.
3. Connect the speaker cable to the connector on the system board.
4. Affix the adhesive tapes to secure the speakers in place.
5. Connect the hard-disk drive cable to the connector on the system board.
6. Connect the touchpad cable, keyboard cable, keyboard backlit LED cable, and USB cable to the connectors on the system board and close the latches.

Next steps

1. Install the [battery](#).
2. Install the [base cover](#).
3. Install the [SIM card tray](#) for 4G LTE enabled systems.
4. Install the [microSD-card](#).
5. Follow the procedure in [after working inside your computer](#).

Touchpad

Removing the touchpad

Prerequisites

1. Follow the procedure in [before working inside your computer](#).
2. Remove the [microSD-card](#).
3. Remove the [SIM card tray](#) for 4G LTE enabled systems.
4. Remove the [base cover](#).
5. Remove the [battery](#).
6. Remove the [speakers](#).

About this task

The following image indicates the location of the touchpad and provides a visual representation of the removal procedure.

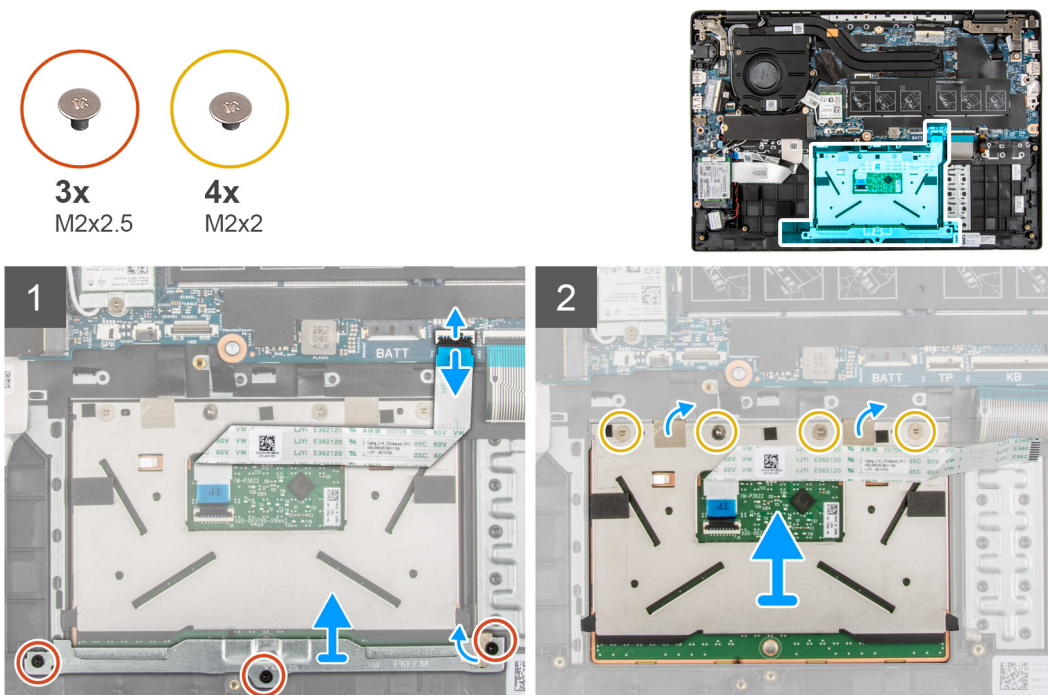

Steps

1. Open the latch and disconnect the touchpad cable from the connector on the system board.
2. Peel the adhesive tapes that secure the touchpad module in place.
3. Remove the three (M2x2.5) screws that secure the touchpad bracket to the touchpad module.
4. Lift and remove the touchpad bracket from the touchpad module.
5. Remove the four (M2x2) screws that secure the touchpad module to the palmrest assembly.
6. Lift and remove the touchpad module from the palmrest assembly.

Installing the touchpad

Prerequisites

If you are replacing a component, remove the existing component before performing the installation procedure.

About this task

The following image indicates the location of the touchpad and provides a visual representation of the installation procedure.

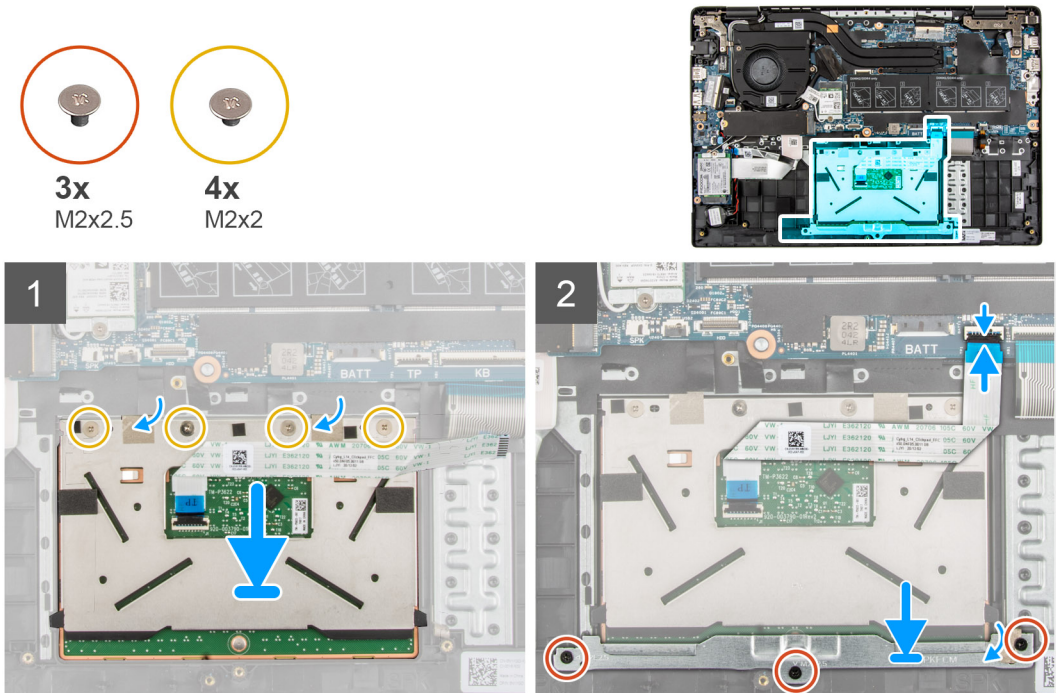

Steps

1. Align and place the touchpad module into the slot on the palmrest assembly.
2. Install the four (M2x2) screws to secure the touchpad module to the palmrest assembly.
3. Align and place the touchpad bracket on the touchpad module.
4. Install the three (M2x2.5) screws to secure the touchpad bracket to the touchpad module.
5. Affix the adhesive tapes to secure the touchpad module in place.
6. Connect the touchpad cable to the connector on the system board and close the latch.

Next steps

1. Install the [speakers](#).
2. Install the [battery](#).
3. Install the [base cover](#).
4. Install the [SIM card tray](#) for 4G LTE enabled systems.
5. Install the [microSD-card](#).
6. Follow the procedure in [after working inside your computer](#).

WWAN I/O board

Removing the WWAN I/O board

Prerequisites

1. Follow the procedure in [before working inside your computer](#).
2. Remove the [microSD card](#).
3. Remove the [SIM card tray](#) for 4G LTE enabled systems.
4. Remove the [base cover](#).
5. Remove the [battery cable](#).

About this task

The following image indicates the location of the WWAN I/O board and provides a visual representation of the removal procedure.

 **NOTE:** The following steps are applicable only for 4G LTE enabled systems.



2x
M2x3

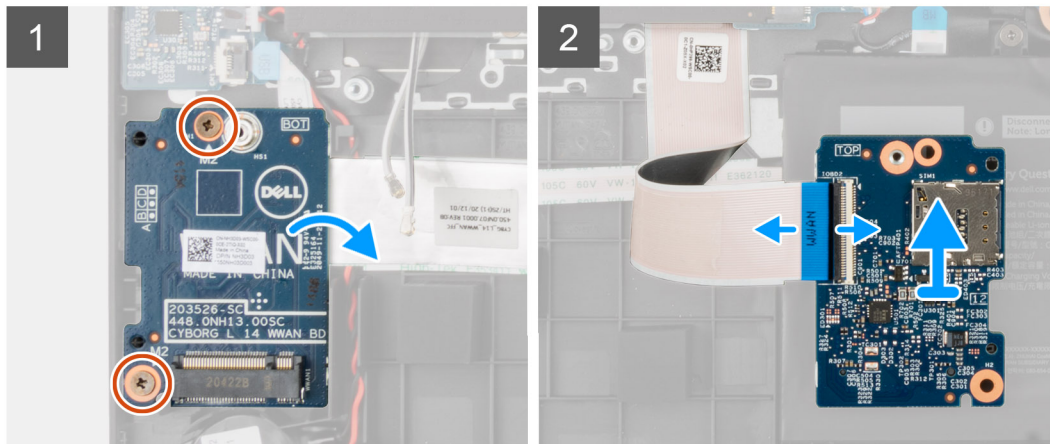
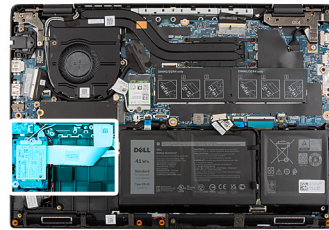

Steps

1. Remove the two (M2x3) screws that secure the WWAN I/O board to the palmrest assembly.
2. Gently flip the WWAN I/O board toward right.
3. Open the latch and disconnect the WWAN cable from the connector on the WWAN I/O board.
4. Lift and remove the WWAN I/O board from the palmrest assembly.

Installing the WWAN I/O board

Prerequisites

If you are replacing a component, remove the existing component before performing the installation procedure.

About this task

The following image indicates the location of the WWAN I/O board and provides a visual representation of the installation procedure.

 **NOTE:** The following steps are applicable only for 4G LTE enabled systems.



2x
M2x3

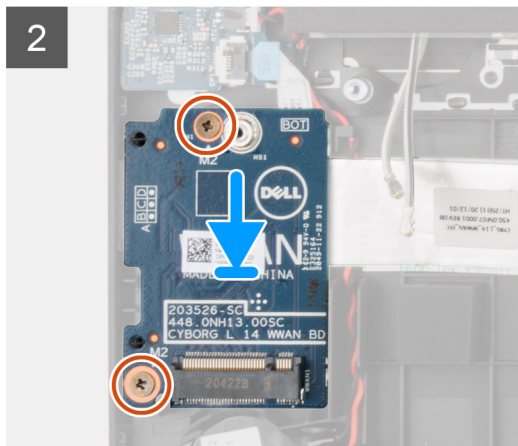
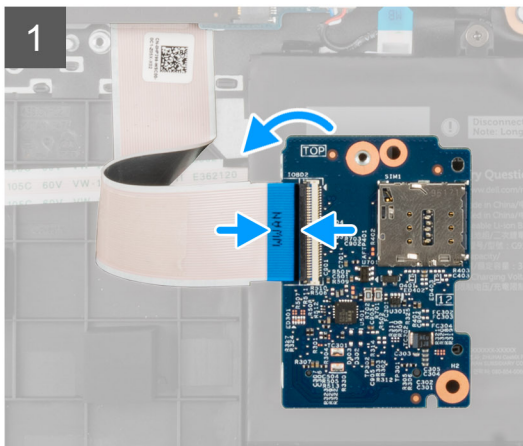
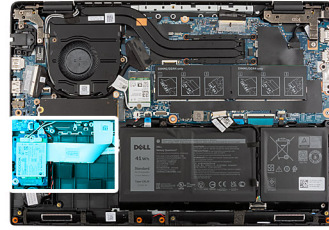

Steps

1. Connect the WWAN cable to the connector on the WWAN I/O board and close the latch.
2. Gently flip the WWAN I/O board toward right.
3. Align and place the WWAN I/O board into its slot on the palmrest assembly.
4. Install the two (M2x3) screws to secure the WWAN I/O board to the palmrest assembly.

Next steps

1. Install the [battery cable](#)
2. Install the [base cover](#).
3. Install the [SIM card tray](#) for 4G LTE enabled systems.
4. Install the [microSD card](#).
5. Follow the procedure in [After working on your computer](#).

Palmrest assembly

Removing the palmrest assembly

Prerequisites

1. Follow the procedure in [before working inside your computer](#).
2. Remove the [microSD-card](#).
3. Remove the [SIM card tray](#) for 4G LTE enabled systems.
4. Remove the [base cover](#).
5. Remove the [battery](#).
6. Remove the [memory module](#).

7. Remove the [M.2 SSD](#).
8. Remove the [M.2 SSD conversion bracket](#).
9. Remove the [M.2 SSD conversion plate](#).
10. Remove the [hard-disk drive](#).
11. Remove the [WLAN card](#).
12. Remove the [WWAN card](#) for systems enabled with 4G LTE.
13. Remove the [I/O board cable](#).
14. Remove the [display assembly](#).
15. Remove the [system fan](#).
16. Remove the [heatsink assembly](#).
17. Remove the [power adapter port](#).
18. Remove the [I/O board](#).
19. Remove the [coin-cell battery](#).
20. Remove the [USB cable](#).
21. Remove the [WWAN I/O board](#) for systems enabled with 4G LTE.
22. Remove the [system board](#).

 **NOTE:** The system board can be removed along with the heat sink.

About this task

The following images indicate the location of the palmrest assembly.

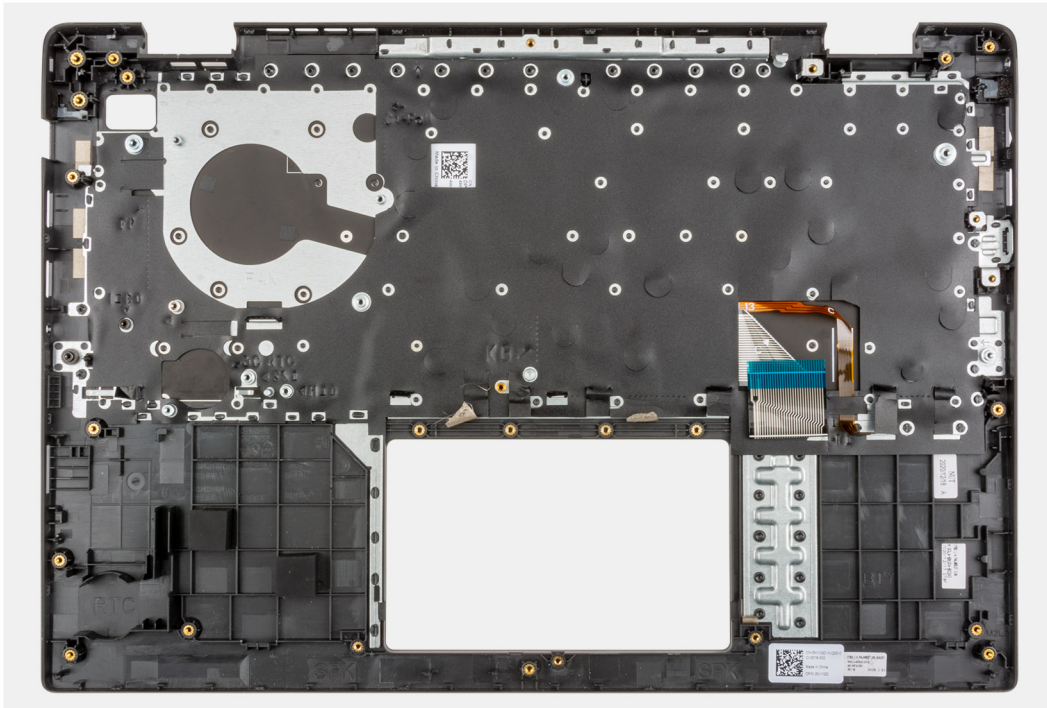

Steps

After performing the preceding steps, you are left with the palmrest assembly.

Installing the palmrest assembly

Prerequisites

If you are replacing a component, remove the existing component before performing the installation procedure.

About this task

The following image indicates the palmrest assembly.

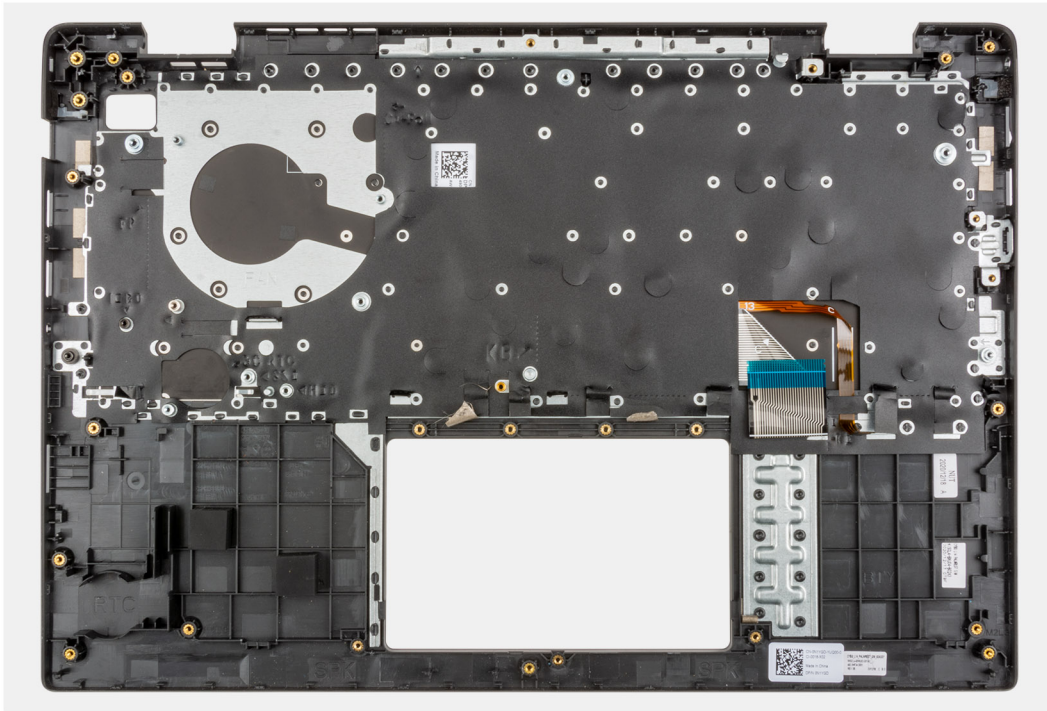

Steps

After performing the succeeding steps, you are left with the palmrest assembly.

Next steps

1. Install the [system board](#).
2. Install the [WWAN I/O board](#) for systems enabled with 4G LTE.
3. Install the [USB cable](#).
4. Install the [coin-cell battery](#).
5. Install the [I/O board](#).
6. Install the [power adapter port](#).
7. Install the [heatsink assembly](#).
8. Install the [system fan](#).
9. Install the [display assembly](#).
10. Install the [I/O board cable](#).
11. Install the [WWAN card](#) for systems enabled with 4G LTE.
12. Install the [WLAN card](#).
13. Install the [hard-disk drive](#).
14. Install the [M.2 SSD conversion plate](#).
15. Install the [M.2 SSD conversion bracket](#).
16. Install the [M.2 SSD](#).
17. Install the [memory module](#).
18. Install the [battery](#).
19. Install the [base cover](#).
20. Install the [SIM card tray](#) for 4G LTE enabled systems.
21. Install the [microSD-card](#).
22. Follow the procedure in [after working inside your computer](#).

Camera

Removing the camera

Prerequisites

1. Follow the procedure in [before working inside your computer](#).
2. Remove the [microSD-card](#).
3. Remove the [SIM card tray](#) for 4G LTE enabled systems.
4. Enter the [service mode](#).
5. Remove the [base cover](#).
6. Remove the [WLAN card](#).
7. Remove the [WWAN card](#) for 4G LTE enabled systems.
8. Remove the [I/O board cable](#).
9. Remove the [display assembly](#).
10. Remove the [display bezel](#).
11. Remove the [display panel](#).

About this task

The following image indicates the location of the camera and provides a visual representation of the removal procedure.

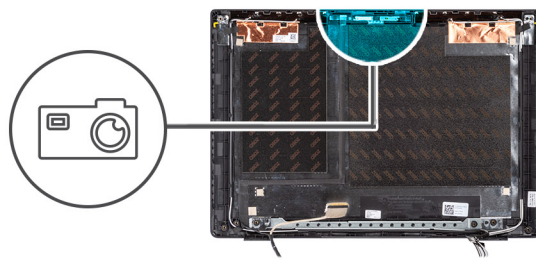

Steps

1. Peel the adhesive that secures the camera cable to the connector on the camera module.
2. Disconnect the camera cable from the connector on the camera module.
3. Peel the camera cable from the display back-cover.
4. Carefully pry loose and remove the camera module from the display back-cover.

Installing the camera

Prerequisites

If you are replacing a component, remove the existing component before performing the installation procedure.

About this task

The following image indicates the location of the camera and provides a visual representation of the installation procedure.

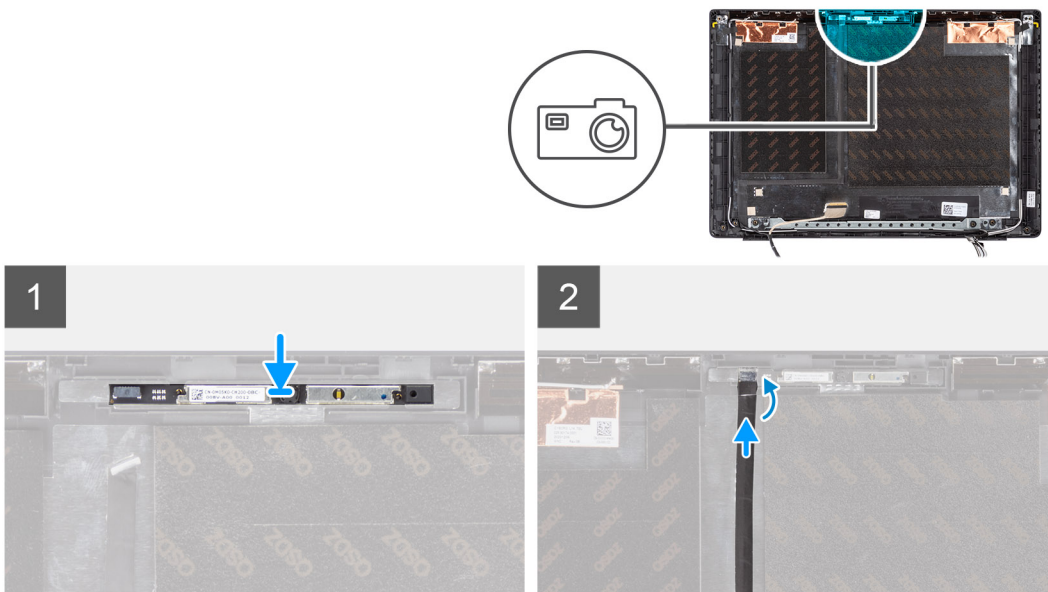

Steps

1. Align and place the camera module into the slot on the display back-cover.
2. Connect the camera cable to the connector on the camera module.
3. Affix the adhesive tape to secure the camera cable to the connector on the camera module.
4. Align and affix the camera cable on the display back-cover.

Next steps

1. Install the [display panel](#).
2. Install the [display bezel](#).
3. Install the [display assembly](#).
4. Install the [I/O board cable](#).
5. Install the [WWAN card](#) for 4G LTE enabled systems.
6. Install the [WLAN card](#).
7. Install the [base cover](#).
8. Exit the [service mode](#)
9. Install the [SIM card tray](#) for 4G LTE enabled systems.
10. Install the [microSD-card](#).
11. Follow the procedure in [after working inside your computer](#).

Display cable

Removing the display cable

Prerequisites

1. Follow the procedure in [before working inside your computer](#).
2. Remove the [microSD-card](#).
3. Remove the [SIM card tray](#) for 4G LTE enabled systems.
4. Enter the [service mode](#).
5. Remove the [base cover](#).
6. Remove the [WLAN card](#).
7. Remove the [WWAN card](#) for 4G LTE enabled systems.

8. Remove the [I/O board cable](#).
9. Remove the [display assembly](#).
10. Remove the [display bezel](#).
11. Remove the [display panel](#).

About this task

The following image indicates the location of the display cable and provides a visual representation of the removal procedure.

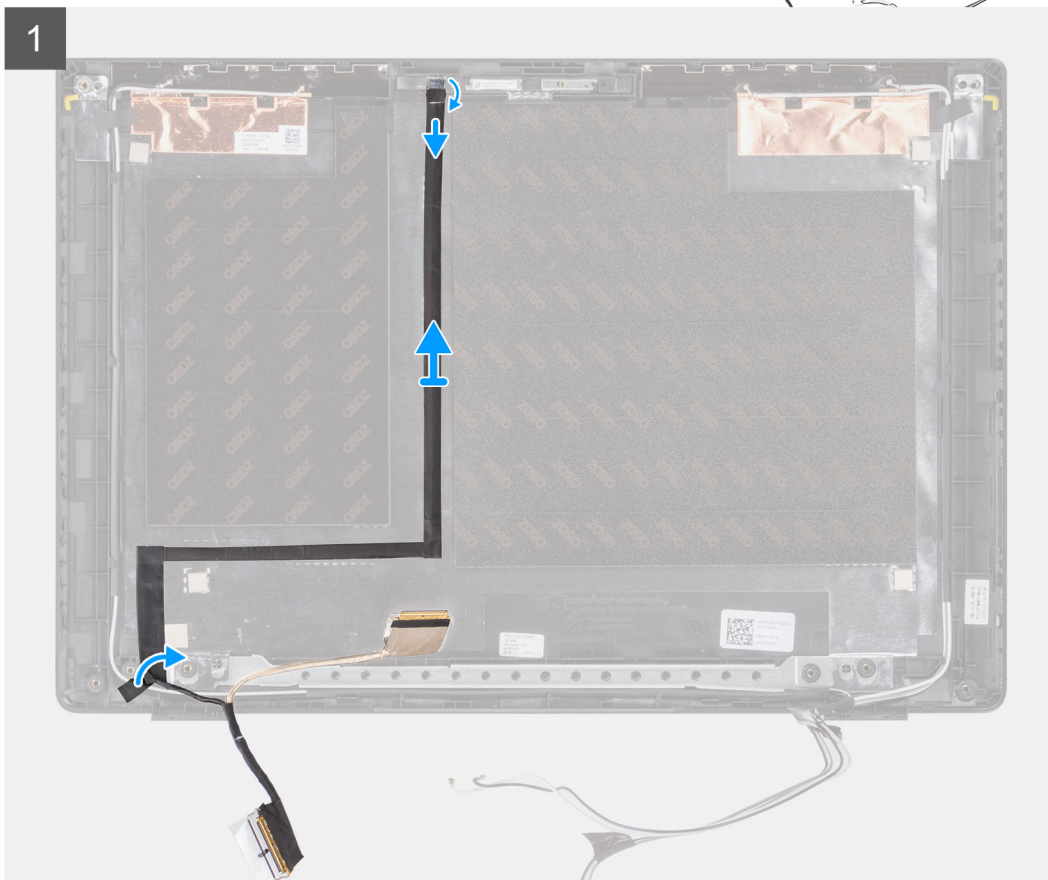
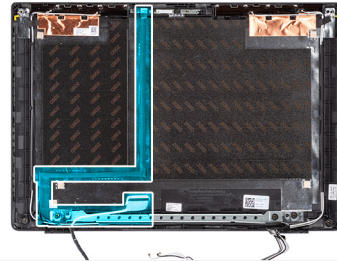

Steps

1. Disconnect the display cable from the connector on the system board.
2. Disconnect the display cable from the connector on the display panel.
3. Disconnect the display cable from the connector on the camera module.

Installing the display cable

Prerequisites

If you are replacing a component, remove the existing component before performing the installation procedure.

About this task

The following image indicates the location of the display cable and provides a visual representation of the installation procedure.

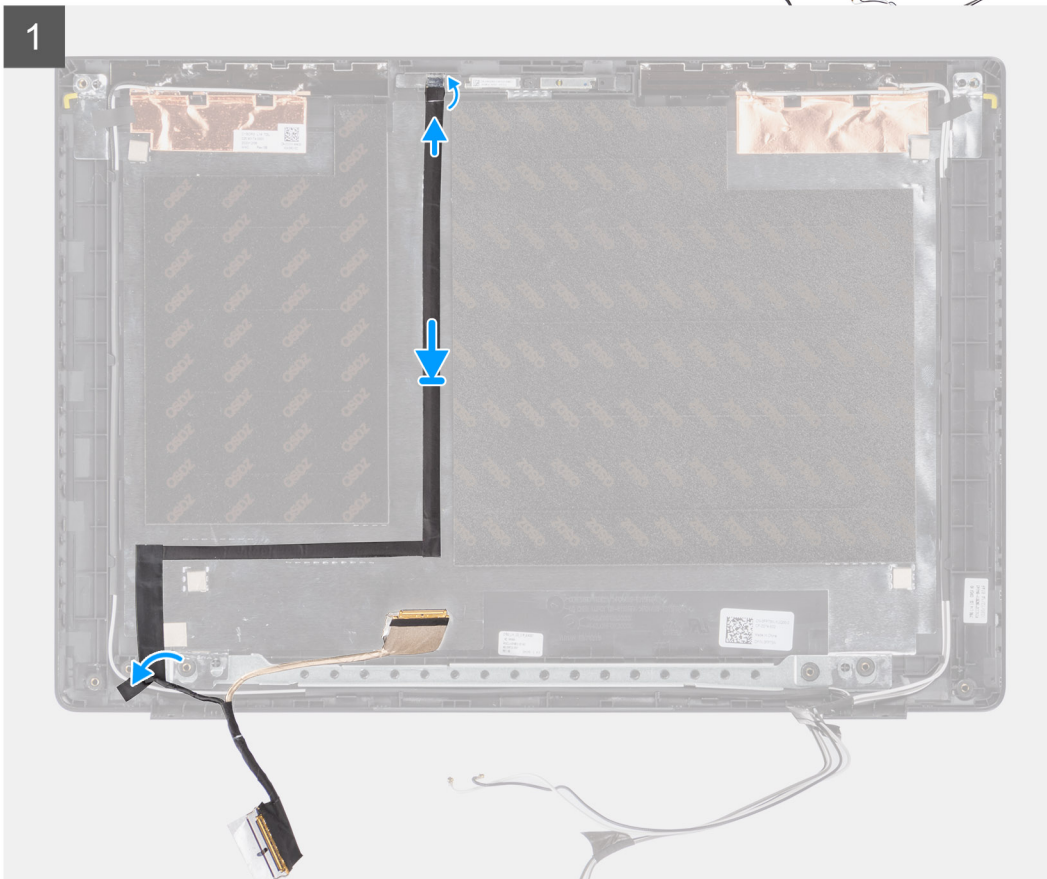
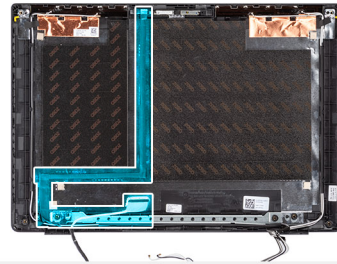

Steps

1. Connect the display cable from the connector on the camera module.
2. Connect the display cable from the connector on the display panel.
3. Connect the display cable from the connector on the system board.

Next steps

1. Install the [display panel](#).
2. Install the [display bezel](#).
3. Install the [display assembly](#).
4. Install the [I/O board cable](#).
5. Install the [WWAN card](#) for 4G LTE enabled systems. .
6. Install the [WLAN card](#).
7. Install the [base cover](#).
8. Exit the [service mode](#)
9. Install the [SIM card tray](#) for 4G LTE enabled systems.
10. Install the [microSD-card](#).
11. Follow the procedure in [after working inside your computer](#).

Display back-cover

Removing the display back-cover

Prerequisites

1. Follow the procedure in [before working inside your computer](#).
2. Remove the [microSD-card](#).
3. Remove the [SIM card tray](#) for 4G LTE enabled systems.
4. Enter the [service mode](#).
5. Remove the [base cover](#).
6. Remove the [WLAN card](#).
7. Remove the [WWAN card](#) for 4G LTE enabled systems.
8. Remove the [I/O board cable](#).
9. Remove the [display assembly](#).
10. Remove the [display bezel](#).
11. Remove the [display panel](#).
12. Remove the [camera](#).
13. Remove the [display cable](#).

About this task

The following images indicate the location of the display back-cover and provide a visual representation of the removal procedure.

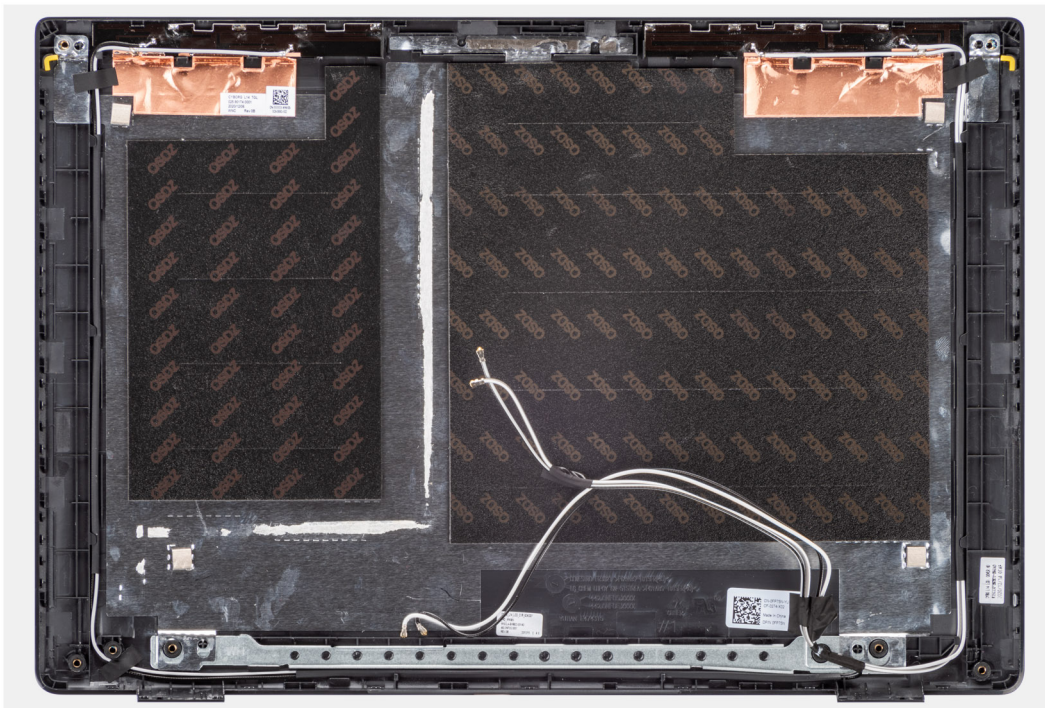

Steps

After performing the preceding steps, you are left with the base cover assembly.

Installing the display back-cover

Prerequisites

If you are replacing a component, remove the existing component before performing the installation procedure.

About this task

The following image indicates the location of the display back-cover and provides a visual representation of the installation procedure.

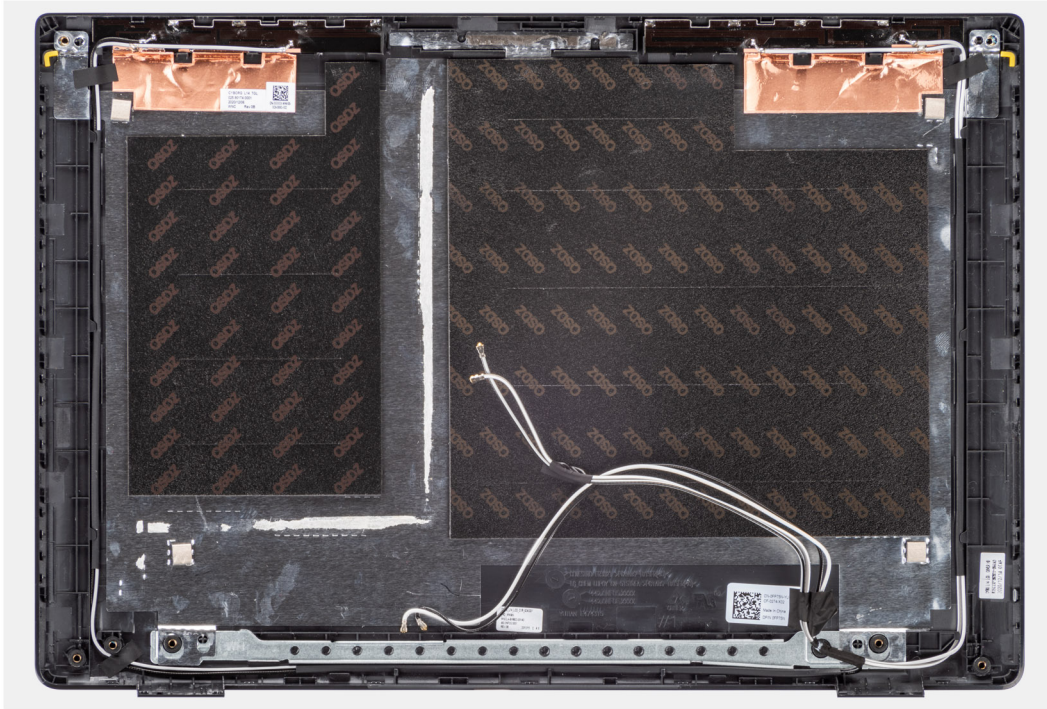

Steps

After performing the succeeding steps, you are left with the base cover assembly.

Next steps

1. Install the [display cable](#).
2. Install the [camera](#).
3. Install the [display panel](#).
4. Install the [display bezel](#).
5. Install the [display assembly](#).
6. Install the [I/O board cable](#).
7. Install the [WWAN card](#) for 4G LTE enabled systems. .
8. Install the [WLAN card](#).
9. Install the [base cover](#).
10. Exit the [service mode](#)
11. Install the [SIM card tray](#) for 4G LTE enabled systems.
12. Install the [microSD-card](#).
13. Follow the procedure in [after working inside your computer](#).

Drivers and downloads

When troubleshooting, downloading or installing drivers it is recommended that you read the Dell Knowledge Based article, Drivers and Downloads FAQ [000123347](#).

BIOS setup

CAUTION: Unless you are an expert computer user, do not change the settings in the BIOS Setup program. Certain changes can make your computer work incorrectly.

NOTE: Depending on the computer and its installed devices, the items listed in this section may or may not be displayed.

NOTE: Before you change BIOS Setup program, it is recommended that you write down the BIOS Setup program screen information for future reference.

Use the BIOS Setup program for the following purposes:

- Get information about the hardware installed in your computer, such as the amount of RAM and the size of the hard drive.
- Change the system configuration information.
- Set or change a user-selectable option, such as the user password, type of hard drive installed, and enabling or disabling base devices.

BIOS overview

The BIOS manages data flow between the computer's operating system and attached devices such as hard disk, video adapter, keyboard, mouse, and printer.

Entering BIOS setup program

Steps

1. Turn on your computer.
2. Press F2 immediately to enter the BIOS setup program.

NOTE: If you wait too long and the operating system logo appears, continue to wait until you see the desktop. Then, turn off your computer and try again.

Navigation keys

NOTE: For most of the System Setup options, changes that you make are recorded but do not take effect until you restart the system.

Table 4. Navigation keys

Keys	Navigation
Up arrow	Moves to the previous field.
Down arrow	Moves to the next field.
Enter	Selects a value in the selected field (if applicable) or follow the link in the field.
Spacebar	Expands or collapses a drop-down list, if applicable.
Tab	Moves to the next focus area. NOTE: For the standard graphics browser only.

Table 4. Navigation keys (continued)

Keys	Navigation
Esc	Moves to the previous page until you view the main screen. Pressing Esc in the main screen displays a message that prompts you to save any unsaved changes and restarts the system.

One time boot menu

To enter **one time boot menu**, turn on your computer, and then press F12 immediately.

i **NOTE:** It is recommended to shutdown the computer if it is on.

The one-time boot menu displays the devices that you can boot from including the diagnostic option. The boot menu options are:

- Removable Drive (if available)
- STXXXX Drive (if available)
 - i** **NOTE:** XXX denotes the SATA drive number.
- Optical Drive (if available)
- SATA Hard Drive (if available)
- Diagnostics

The boot sequence screen also displays the option to access the System Setup screen.

System setup options

i **NOTE:** Depending on your system and its installed devices, the items that are listed in this section may or may not appear.

Table 5. System setup options—System information menu

Overview	
Latitude 3420	
BIOS Version	Displays the BIOS version number.
Service Tag	Displays the Service Tag of the system.
Asset Tag	Displays the Asset Tag of the system.
Manufacture Date	Displays the manufacture date of the system.
Ownership Date	Displays the ownership date of the system.
Express Service Code	Displays the express service code of the system.
Ownership Tag	Displays the Ownership Tag of the system.
Signed Firmware Update	Displays whether the Signed Firmware Update is enabled on your system.
Battery Information	
Primary	Displays that battery is primary.
Battery Level	Displays the battery level of the system.
Battery State	Displays the battery state of the system.
Health	Displays the battery health of the system.
AC Adapter	Displays whether the AC adapter is connected or not.
Processor Information	
Processor Type	Displays the processor type.

Table 5. System setup options—System information menu (continued)

Overview	
Maximum Clock Speed	Displays the maximum processor clock speed.
Minimum Clock Speed	Displays the minimum processor clock speed.
Current Clock Speed	Displays the current processor clock speed.
Core Count	Displays the number of cores on the processor.
Processor ID	Displays the processor identification code.
Processor L2 Cache	Displays the processor L2 Cache size.
Processor L3 Cache	Displays the processor L3 Cache size.
Microcode Version	Displays the microcode version.
Intel Hyper-Threading Capable	Displays whether the processor is Hyper-Threading (HT) capable.
64-Bit Technology	Displays whether 64-bit technology is used.
Memory Information	
Memory Installed	Displays the total system memory installed.
Memory Available	Displays the total system memory available.
Memory Speed	Displays the memory speed.
Memory Channel Mode	Displays single or dual channel mode.
Memory Technology	Displays the technology that is used for the memory.
DIMM SLOT 1	Displays DIMM slot information.
DIMM SLOT 2	Displays DIMM slot information.
Devices Information	
Panel Type	Displays the Panel Type of the system.
Video Controller	Displays the video controller type of the system.
Video Memory	Displays the video memory information of the system.
Wi-Fi Device	Displays the wireless device information of the system.
Native Resolution	Displays the native resolution of the system.
Video BIOS Version	Displays the video BIOS version of the system.
Audio Controller	Displays the audio controller information of the system.
Bluetooth Device	Displays the Bluetooth device information of the system.
LOM MAC Address	Displays the LAN On Motherboard (LOM) MAC address of the system.
Pass Through MAC Address	Displays the pass through MAC address of the system.
Cellular Device	Displays the M.2 PCIe SSD information of the system.
dGPU Video Controller (For systems with discrete video card only)	Displays the video controller information.

Table 6. System setup options—Boot Configuration menu

Boot Configuration	
Boot Sequence	
Boot mode	Displays the boot mode. NOTE: Legacy Boot mode is not supported on this platform.
Boot Sequence	Displays the boot sequence.
Secure Digital (SD) Card Boot	Enable or disable the SD card read-only boot.

Table 6. System setup options—Boot Configuration menu (continued)

Boot Configuration	
	By default, the Secure Digital (SD) Card Boot option is not enabled.
Secure Boot	
Enable Secure Boot	Enable or disable the secure boot feature. By default, the option is disabled.
Secure Boot Mode	Allows you to modify the secure boot mode options. By default, the Deployed Mode is enabled. By default, the Audit Mode is disabled.
Expert Key Management	
Enable Custom Mode	Enable or disable custom mode. By default, the custom mode option is not enabled.
Custom Mode Key Management	Allows you to select the custom values for expert key management.

Table 7. System setup options—Integrated Devices menu

Integrated Devices	
Date/Time	Displays the current date in MM/DD/YYYY format and current time in HH:MM:SS AM/PM format.
Camera	Enables or disable the camera. By default, the Enable Camera option is selected
Audio	
Enable Audio	Enable or disable the integrated audio controller. By default, the Enable Audio option is enabled. By default, the Enable Microphone option is enabled. By default, the Enable Internal Speaker option is enabled.
USB Configuration	<ul style="list-style-type: none"> Enable or disable booting from USB mass storage devices that are connected to external USB ports. By default, the Enable External USB Ports option is enabled. Enable or disable booting from USB mass storage devices such as external hard drive, optical drive, and USB drive. By default, the Enable USB Boot Support option is enabled.
Disable USB4 PCIE Tunneling (For systems with discrete video card only)	Disable the USB4 PCIE Tunneling option. By default, this option is disabled.
Video/Power only on Type-C Ports (For systems with discrete video card only)	Enable or disable the Type-C port functionality to video or only power. By default, the Video/Power only on Type-C Ports option is disabled.

Table 8. System setup options—Storage menu

Storage	
SATA/NVMe Operation	
SATA/NVMe Operation	Set the operating mode of the integrated storage device controller. By default, the RAID On option is enabled.
Storage interface	

Table 8. System setup options—Storage menu (continued)

Storage	
Port Enablement	This page allows you to enable the onboard drives. By default, the SATA-1 option is enabled. By default, the M.2 PCIe SSD-1 option is enabled.
SMART Reporting	
Enable SMART Reporting	Enable or disable Self-Monitoring, Analysis, and Reporting Technology (SMART) during system startup. By default, the Enable SMART Reporting option is disabled.
Drive Information	
SATA-1	
Type	Displays the SATA type information of the system.
Device	Displays the SATA device information of the system.
M.2 PCIe SSD-1	
Type	Displays the M.2 PCIe SSD type information of the system.
Device	Displays the M.2 PCIe SSD device information of the system.
Enable Hard Drive Free Fall Protection	
Enable Hard Drive Free Fall Protection	Allows you to enable Hard Drive Free Fall Protection feature. By default, the Enable Hard Drive Free Fall Protection option is selected.
Enable MediaCard	
	Enable or disable the media card in read-only state. By default, the Secure Digital (SD) Card option is enabled.

Table 9. System setup options—Display menu

Display	
Display Brightness	
Brightness on battery power	Enable to set screen brightness when the system is running on battery power.
Brightness on AC power	Enable to set screen brightness when the system is running on AC power.
Touchscreen	
	Enable or disable touchscreen for the operating system. Touchscreen will always work in the BIOS setup irrespective of this setting. This option is enabled by default.
EcoPower	
Enable EcoPower	Enable or disabled EcoPower feature. This option is enabled by default.
Full Screen Logo	
	Enable or disable full screen logo. By default, the option is disabled.

Table 10. System setup options—Connection menu

Connection	
Network Controller Configuration	
Integrated NIC	If enabled, UEFI network protocols are installed and available, allowing pre-OS and early OS networking features to use any enabled NICs. The option Enable with PXE is enabled by default.

Table 10. System setup options—Connection menu (continued)

Connection	
Wireless Device Enable	
WWAN/GPS (For systems with integrated video card only)	Enable or disable the internal WWAN/GPS device. By default, the option enabled.
WLAN	Enable or disable the internal WLAN device. By default, the option enabled.
Bluetooth	Enable or disable the internal Bluetooth device. By default, the option enabled.
Enable UEFI Network Stack	Enable or disable UEFI Network Stack. By default, the Enable UEFI Network Stack option is enabled.
Wireless Radio Control	
Control WLAN radio	Sense the connection of the system to a wired network and subsequently disable the selected wireless radios (WLAN). By default, the option is disabled.
Control WWAN radio	Sense the connection of the system to a wired network and subsequently disable the selected wireless radios (WWAN). By default, the option is disabled.
HTTPs Boot Feature (For systems with discrete video card only)	
HTTPs Boot	Enable or disable the HTTPs Boot feature. By default, the HTTPs Boot option is enabled.

Table 11. System setup options—Power menu

Power	
Battery configuration	Enables the system to run on battery during peak power usage hours. Use the table Custom Charge Start and Custom Charge Stop , to prevent AC power usage between certain times of each day. By default, the Adaptive option is enabled.
Advanced Configuration	
Enable Advanced Battery Charge Configuration	Enable or disable the advanced battery charge configuration. By default, the Enable Advanced Battery Charge Configuration option is disabled.
Peak Shift	Enables the system to run on battery during peak power usage hours. By default, the Enable Peak Shift option is disabled.
USB PowerShare	
Enable USB PowerShare	Enable or disable the USB PowerShare. By default, the Enable USB PowerShare option is disabled
Thermal Management	Enables to cool the fan and processor heat management to adjust the system performance, noise, and temperature. By default, the Optimized option is enabled.
USB Wake Support	
Enable USB Wake Support	Enables USB wake support.

Table 11. System setup options—Power menu (continued)

Power	
Wake on Dell USB-C Dock	<p>By default, the Enable USB Wake Support option is disabled.</p> <p>When enabled, connecting a Dell USB-C Dock will wake the system from standby.</p> <p>By default, the Wake on Dell USB-C Dock option is enabled.</p>
Block Sleep	<p>Enables to block entering sleep (S3) mode in the operating system.</p> <p>By default, the Block Sleep option is disabled.</p>
Lid Switch	<p>Enable or disable the lid switch.</p> <p>By default, the Lid Switch option is enabled.</p>
Power On Lid Open	<p>Enables or disables system Power up from Off state when the lid is opened.</p> <p>By default, the Power On Lid Open option is enabled.</p>
Intel Speed Shift Technology	<p>Enable or disable the Intel speed shift technology support.</p> <p>By default, the Intel Speed Shift Technology option is enabled.</p>

Table 12. System setup options—Security menu

Security	
TPM 2.0 Security	
TPM 2.0 Security On	<p>Enable or disable TPM 2.0 security options.</p> <p>By default, the TPM 2.0 Security On option is enabled.</p>
PPI Bypass for Enable Commands	<p>Enables to control TPM Physical Presence Interface (PPI).</p> <p>By default, the PPI Bypass for Enable Commands option is disabled.</p>
PPI Bypass for Disable Commands	<p>Enables to control TPM Physical Presence Interface (PPI).</p> <p>By default, the PPI Bypass for Disable Commands option is disabled.</p>
Attestation Enable	<p>Enables to control whether the Trusted Platform Module (TPM) Endorsement Hierarchy is available to the operating system.</p> <p>By default, the Attestation Enable option is enabled.</p>
Key Storage Enable	<p>Enables to control whether the Trusted Platform Module (TPM) Storage Hierarchy is available to the operating system.</p> <p>By default, the Key Storage Enable option is enabled.</p>
SHA-256	<p>BIOS and the TPM will use the SHA-256 hash algorithm to extend measurements into the TPM PCRs during BIOS boot.</p> <p>By default, the SHA-256 option is enabled.</p>
Clear	<p>Enables to clear the TPM owner information and returns the TPM to the default state.</p> <p>By default, the Clear option is disabled.</p>
PPI ByPass for Clear Commands	<p>Controls the TPM Physical Presence Interface (PPI).</p> <p>By default, the PPI ByPass for clear Commands option is disabled.</p>
TPM State	<p>Enables or disables TPM.</p> <p>By default, the option is enabled.</p>
Intel Software Guard Extensions	

Table 12. System setup options—Security menu (continued)

Security	
Intel SGX	<p>Enable Intel Software Guard Extensions (SGX) to provide a secured environment for running code/storing sensitive information in the context of the main operating system.</p> <p>By default, the Software Control option is enabled.</p>
SMM Security Mitigation	<p>Enable or disable SMM Security Mitigation.</p> <p>By default, the option is enabled.</p>
Data Wipe on Next Boot	
Start Data Wipe	<p>Enable or disable the data wipe on next boot.</p> <p>By default, the option is disabled.</p>
Absolute	<p>Enable or disable or permanently disable the BIOS module interface of the optional Absolute Persistence Module service from Absolute software.</p> <p>By default, the option is enabled.</p>
UEFI Boot Path Security	<p>Controls whether the system will prompt the user to enter the admin password (if set) when booting to a UEFI boot device from the F12 boot menu.</p> <p>By default, the Always Except Internal HDD option is enabled.</p>

Table 13. System setup options—Passwords menu

Passwords	
Admin Password	Set, change, or delete the administrator password.
System Password	Set, change, or delete the system password.
Internal HDD-1 Password	Set, change, or delete the Internal HDD-1 password.
NVMe SSD0	Set, change, or delete the NVMe SSD0 password.
Password Configuration	
Upper Case Letter	<p>Reinforces password must have at least one upper case letter.</p> <p>By default, the option is enabled.</p>
Lower Case Letter	<p>Reinforces password must have at least one lower case letter.</p> <p>By default, the option is enabled.</p>
Digit	<p>Reinforces password must have at least one digit.</p> <p>By default, the option is enabled.</p>
Special Character	<p>Reinforces password must have at least one special character.</p> <p>By default, the option is enabled.</p>
Minimum Characters	Set the minimum characters allowed for password.
Password Bypass	<p>When enabled, this always prompts for system and internal hard drive passwords when powered on from the off state.</p> <p>By default, the Disabled option is selected.</p>
Password Changes	
Enable Non-Admin Password Changes	<p>Enable or disable to change system and hard drive password without the need for admin password.</p> <p>By default, the option is disabled.</p>
Admin Setup Lockout	

Table 13. System setup options—Passwords menu (continued)

Passwords	
Enable Admin Setup Lockout	Enables administrators control over how their users can or cannot access BIOS setup. By default, the option is disabled.
Master Password Lockout	
Enable Master Password Lockout	When enabled, this disables the master password support. By default, the option is disabled.
Allow Non-Admin PSID Revert (For systems with discrete video card only)	
Enable Allow Non-Admin PSID Revert	Controls access to the Physical Security ID (PSID) revert of NVMe hard-drives from the Dell Security Manager prompt. By default, the option is disabled.

Table 14. System setup options—Update, Recovery menu

Update, Recovery	
UEFI Capsule Firmware Updates	Enable or disable BIOS updates through UEFI capsule update packages. By default, the option is enabled.
BIOS Recovery from Hard Drive	Enables the user to recover from certain corrupted BIOS conditions from a recovery file on the user primary hard drive or an external USB key. By default, the option is enabled.
BIOS Downgrade	
Allow BIOS Downgrade	Enable or disable the flashing of the system firmware to previous revision is blocked. By default, the option is enabled.
SupportAssist OS Recovery	Enable or disable the boot flow for SupportAssist OS Recovery tool in the event of certain system errors. By default, the option is enabled.
BIOSConnect	Enable or disable cloud Service operating system recovery if the main operating system fails to boot with the number of failures equal to or greater than the value specified by the Auto operating system Recovery Threshold setup option and local Service operating system does not boot or is not installed. By default, the option is enabled.
Dell Auto operating system Recovery Threshold	Controls the automatic boot flow for SupportAssist System Resolution Console and for Dell operating system Recovery Tool. By default, the threshold value is set to 2.

Table 15. System setup options—System Management menu

System Management	
Service Tag	Display the Service Tag of the system.
Asset Tag	Create a system Asset Tag.
AC Behavior	
Wake on AC	Enable or disable the wake on AC option. By default, the option is disabled.
Wake on LAN	

Table 15. System setup options—System Management menu (continued)

System Management	
Wake on LAN	<p>Enable or disable the system to power on by special LAN signals when it receives a wakeup signal from the WLAN.</p> <p>By default, the Disabled option is selected.</p>
Auto on Time	<p>Enable to set the system to turn on automatically every day or on a preselected date and time. This option can be configured only if the Auto On Time is set to Everyday, Weekdays, or Selected Days.</p> <p>By default, the option is disabled.</p>

Table 16. System setup options—Keyboard menu

Keyboard	
Numlock Options	By default, the Numlock option is enabled.
Fn Lock Options	By default, the Fn lock option is enabled.
Lock Mode	By default, Lock Mode Secondary is enabled.
Keyboard Illumination	<p>Enables to change the keyboard illumination settings.</p> <p>By default, the Bright option is enabled.</p>
Keyboard Backlight Timeout on AC	<p>Set the timeout value for the keyboard backlight when an AC adapter is connected to the system.</p> <p>By default, the 1 minute option is enabled.</p>
Keyboard Backlight Timeout on Battery	<p>Set the timeout value for the keyboard backlight when the is running only on battery power.</p> <p>By default, the 1 minute option is enabled.</p>

Table 17. System setup options—Pre-boot Behavior menu

Pre-boot Behavior	
Adapter Warnings	
Enable Adapter Warnings	<p>Enable or disable the warning messages during boot when the adapters with less power capacity are detected.</p> <p>By default, the option is enabled.</p>
Warning and Errors	<p>Enable or disable the action to be done when a warning or error is encountered.</p> <p>By default, the Prompt on Warnings and Errors option is enabled.</p>
USB-C Warnings	
Enable Dock Warning Messages	By default, the option is enabled.
Fastboot	<p>Enable to set the speed of the boot process.</p> <p>By default, the Thorough option is enabled.</p>
Extend BIOS POST Time	<p>Set the BIOS POST time.</p> <p>By default, the 0 seconds option is enabled.</p>
MAC Address Pass-Through	<p>Replaces the external NIC MAC address with the selected MAC address from the system.</p> <p>By default, the System Unique MAC Address option is enabled.</p>

Table 18. System setup options—Virtualization menu

Virtualization	
Intel Virtualization Technology	
Enable Intel Virtualization Technology (VT)	Specify whether a Virtual Machine Monitor (VMM) can use the additional hardware capabilities that are provided by Intel Virtualization Technology. By default, the option is enabled.
VT for Direct I/O	
	Specify whether a Virtual Machine Monitor (VMM) can use the additional hardware capabilities that are provided by Intel Virtualization Technology for Direct I/O. By default, the option is enabled.

Table 19. System setup options—Performance menu

Performance	
Multi Core Support	
Active Cores	Enables to change the number of CPU cores available to the operating system. By default, the All Cores option is enabled.
Intel SpeedStep	
Enable Intel SpeedStep Technology	Enables the system to dynamically adjust processor voltage and core frequency, decreasing average power consumption and heat production. By default, the option is enabled.
C-States Control	
Enable C-State Control	Enable or disable additional processor sleep states. By default, the option is enabled.
Enable Adaptive C-States for Discrete Graphics	Enable or disable usage of Discrete graphics and requires AC adapter due to higher energy consumption. By default, the option is enabled.
Intel TurbocBoost Technology	
Enable Intel Turbo Boost Technology	Enable or disable Intel TurboBoost mode of the processor. By default, the option is enabled.
Intel Hyper-Threading Technology	
Enable Intel Hyper-Threading Technology	Enable or disable Hyper-Threading in the processor. By default, the option is enabled.

Table 20. System setup options—System Logs menu

System Logs	
BIOS Event Log	
Clear Bios Event Log	Display BIOS events. By default, the Keep option is enabled.
Thermal Event Log	
Clear Thermal Event Log	Display Thermal events. By default, the Keep option is enabled.
Power Event Log	
Clear Power Event Log	Display power events.

Table 20. System setup options—System Logs menu (continued)

System Logs	
	By default, the Keep option is enabled.
License Information	Displays the license information of the system.

Updating the BIOS

Updating the BIOS in Windows

About this task

CAUTION: If BitLocker is not suspended before updating the BIOS, the next time you reboot the system it will not recognize the BitLocker key. You will then be prompted to enter the recovery key to progress and the system will ask for this on each reboot. If the recovery key is not known this can result in data loss or an unnecessary operating system re-install. For more information on this subject, see Knowledge Article: <https://www.dell.com/support/article/sln153694>

Steps

1. Go to www.dell.com/support.
2. Click **Product support**. In the **Search support** box, enter the Service Tag of your computer, and then click **Search**.
NOTE: If you do not have the Service Tag, use the SupportAssist feature to automatically identify your computer. You can also use the product ID or manually browse for your computer model.
3. Click **Drivers & Downloads**. Expand **Find drivers**.
4. Select the operating system installed on your computer.
5. In the **Category** drop-down list, select **BIOS**.
6. Select the latest version of BIOS, and click **Download** to download the BIOS file for your computer.
7. After the download is complete, browse the folder where you saved the BIOS update file.
8. Double-click the BIOS update file icon and follow the on-screen instructions.
For more information, see knowledge base article [000124211](http://www.dell.com/support/article/000124211) at www.dell.com/support.

Updating the BIOS in Linux and Ubuntu

To update the system BIOS on a computer that is installed with Linux or Ubuntu, see the knowledge base article [000131486](http://www.dell.com/support/article/000131486) at www.dell.com/support.

Updating the BIOS using the USB drive in Windows

About this task

CAUTION: If BitLocker is not suspended before updating the BIOS, the next time you reboot the system it will not recognize the BitLocker key. You will then be prompted to enter the recovery key to progress and the system will ask for this on each reboot. If the recovery key is not known this can result in data loss or an unnecessary operating system re-install. For more information on this subject, see Knowledge Article: <https://www.dell.com/support/article/sln153694>

Steps

1. Follow the procedure from step 1 to step 6 in [Updating the BIOS in Windows](#) to download the latest BIOS setup program file.
2. Create a bootable USB drive. For more information, see the knowledge base article [000145519](http://www.dell.com/support/article/000145519) at www.dell.com/support.

3. Copy the BIOS setup program file to the bootable USB drive.
4. Connect the bootable USB drive to the computer that needs the BIOS update.
5. Restart the computer and press **F12** .
6. Select the USB drive from the **One Time Boot Menu**.
7. Type the BIOS setup program filename and press **Enter**.
The **BIOS Update Utility** appears.
8. Follow the on-screen instructions to complete the BIOS update.

Updating the BIOS from the F12 One-Time boot menu

Update your computer BIOS using the BIOS update.exe file that is copied to a FAT32 USB drive and booting from the F12 One-Time boot menu.

About this task

 **CAUTION:** If BitLocker is not suspended before updating the BIOS, the next time you reboot the system it will not recognize the BitLocker key. You will then be prompted to enter the recovery key to progress and the system will ask for this on each reboot. If the recovery key is not known this can result in data loss or an unnecessary operating system re-install. For more information on this subject, see Knowledge Article: <https://www.dell.com/support/article/sln153694>

BIOS Update

You can run the BIOS update file from Windows using a bootable USB drive or you can also update the BIOS from the F12 One-Time boot menu on the computer.

Most of the Dell computers built after 2012 have this capability, and you can confirm by booting your computer to the F12 One-Time Boot Menu to see if BIOS FLASH UPDATE is listed as a boot option for your computer. If the option is listed, then the BIOS supports this BIOS update option.

 **NOTE:** Only computers with BIOS Flash Update option in the F12 One-Time boot menu can use this function.

Updating from the One-Time boot menu

To update your BIOS from the F12 One-Time boot menu, you need the following:

- USB drive formatted to the FAT32 file system (key does not have to be bootable)
- BIOS executable file that you downloaded from the Dell Support website and copied to the root of the USB drive
- AC power adapter that is connected to the computer
- Functional computer battery to flash the BIOS

Perform the following steps to perform the BIOS update flash process from the F12 menu:

 **CAUTION:** Do not turn off the computer during the BIOS update process. The computer may not boot if you turn off your computer.

Steps

1. From a turn off state, insert the USB drive where you copied the flash into a USB port of the computer.
2. Turn on the computer and press F12 to access the One-Time Boot Menu, select BIOS Update using the mouse or arrow keys then press Enter.
The flash BIOS menu is displayed.
3. Click **Flash from file**.
4. Select external USB device.
5. Select the file and double-click the flash target file, and then click **Submit**.
6. Click **Update BIOS**. The computer restarts to flash the BIOS.
7. The computer will restart after the BIOS update is completed.

System and setup password

Table 21. System and setup password

Password type	Description
System password	Password that you must enter to log in to your system.
Setup password	Password that you must enter to access and make changes to the BIOS settings of your computer.

You can create a system password and a setup password to secure your computer.

 **CAUTION:** The password features provide a basic level of security for the data on your computer.

 **CAUTION:** Anyone can access the data that is stored on your computer if it is not locked and left unattended.

 **NOTE:** System and setup password feature is disabled.

Assigning a system setup password

Prerequisites

You can assign a new **System or Admin Password** only when the status is in **Not Set**.

About this task

To enter the system setup, press F12 immediately after a power-on or reboot.

Steps

1. In the **System BIOS** or **System Setup** screen, select **Security** and press Enter.
The **Security** screen is displayed.
2. Select **System/Admin Password** and create a password in the **Enter the new password** field.
Use the following guidelines to assign the system password:
 - A password can have up to 32 characters.
 - The password can contain the numbers 0 through 9.
 - Only lower case letters are valid, upper case letters are not valid.
 - Only the following special characters are valid: Space, ("), (+), (.), (-), (.), (/), (:), ([), (\), (]), (`).
3. Type the system password that you entered earlier in the **Confirm new password** field and click **OK**.
4. Press Esc and a message prompt's you to save the changes.
5. Press Y to save the changes.
The computer restarts.

Deleting or changing an existing system setup password

Prerequisites

Ensure that the **Password Status** is Unlocked (in the System Setup) before attempting to delete or change the existing System and/or Setup password. You cannot delete or change an existing System or Setup password, if the **Password Status** is Locked.

About this task

To enter the System Setup, press F12 immediately after a power-on or reboot.

Steps

1. In the **System BIOS** or **System Setup** screen, select **System Security** and press Enter.
The **System Security** screen is displayed.

2. In the **System Security** screen, verify that **Password Status** is **Unlocked**.
3. Select **System Password**, update, or delete the existing system password, and press Enter or Tab.
4. Select **Setup Password**, update, or delete the existing setup password, and press Enter or Tab.
 -  **NOTE:** If you change the System and/or Setup password, reenter the new password when prompted. If you delete the System and/or Setup password, confirm the deletion when prompted.
5. Press Esc and a message prompts you to save the changes.
6. Press Y to save the changes and exit from System Setup.
The computer restarts.

Clearing CMOS settings

About this task

 **CAUTION:** Clearing CMOS settings will reset the BIOS settings on your computer.

Steps

1. Remove the [base cover](#).
2. Disconnect the battery cable from the system board.
3. Remove the [coin-cell battery](#).
4. Wait for one minute.
5. Replace the [coin-cell battery](#).
6. Connect the battery cable to the system board.
7. Replace the [base cover](#).

Clearing BIOS (System Setup) and System passwords

About this task

To clear the system or BIOS passwords, contact Dell technical support as described at www.dell.com/contactdell.

 **NOTE:** For information on how to reset Windows or application passwords, refer to the documentation accompanying Windows or your application.

Troubleshooting

Handling swollen rechargeable Li-ion batteries

Like most laptops, Dell laptops use rechargeable Li-ion batteries. One type of rechargeable li-ion battery is the rechargeable Li-ion battery. Rechargeable Li-ion batteries have increased in popularity in recent years and have become standard in the electronics industry due to customer preferences for a slim form factor (especially with newer ultra-thin laptops) and long battery life. Inherent to rechargeable Li-ion battery technology is the potential for swelling of the battery cells.

Swollen battery may impact the performance of the laptop. To prevent possible further damage to the device enclosure or internal components leading to malfunction, discontinue the use of the laptop and discharge it by disconnecting the AC adapter and letting the battery drain.

Swollen batteries should not be used and should be replaced and disposed of properly. We recommend contacting Dell product support for options to replace a swollen battery under the terms of the applicable warranty or service contract, including options for replacement by a Dell authorized service technician.

The guidelines for handling and replacing rechargeable Li-ion batteries are as follows:

- Exercise caution when handling rechargeable Li-ion batteries.
- Discharge the battery before removing it from the system. To discharge the battery, unplug the AC adapter from the system and operate the system only on battery power. When the system will no longer power on when the power button is pressed, the battery is fully discharged.
- Do not crush, drop, mutilate, or penetrate the battery with foreign objects.
- Do not expose the battery to high temperatures, or disassemble battery packs and cells.
- Do not apply pressure to the surface of the battery.
- Do not bend the battery.
- Do not use tools of any type to pry on or against the battery.
- If a battery gets stuck in a device as a result of swelling, do not try to free it as puncturing, bending, or crushing a battery can be dangerous.
- Do not attempt to reassemble a damaged or swollen battery into a laptop.
- Swollen batteries that are covered under warranty should be returned to Dell in an approved shipping container (provided by Dell)—this is to comply with transportation regulations. Swollen batteries that are not covered under warranty should be disposed of at an approved recycling center. Contact Dell product support at <https://www.dell.com/support> for assistance and further instructions.
- Using a non-Dell or incompatible battery may increase the risk of fire or explosion. Replace the battery only with a compatible battery purchased from Dell that is designed to work with your Dell computer. Do not use a battery from other computers with your computer. Always purchase genuine batteries from <https://www.dell.com> or otherwise directly from Dell.

Rechargeable Li-ion batteries can swell for various reasons such as age, number of charge cycles, or exposure to high heat. For more information on how to improve the performance and lifespan of the laptop battery and to minimize the possibility of occurrence of the issue, search Dell Laptop Battery in the Knowledge Base Resource at www.dell.com/support.

Dell SupportAssist Pre-boot System Performance Check diagnostics

About this task

SupportAssist diagnostics (also known as system diagnostics) performs a complete check of your hardware. The Dell SupportAssist Pre-boot System Performance Check diagnostics is embedded with the BIOS and is launched by the BIOS internally. The embedded system diagnostics provides a set of options for particular devices or device groups allowing you to:

- Run tests automatically or in an interactive mode
- Repeat tests
- Display or save test results

- Run thorough tests to introduce additional test options to provide extra information about the failed device(s)
- View status messages that inform you if tests are completed successfully
- View error messages that inform you of problems encountered during testing

NOTE: Some tests for specific devices require user interaction. Always ensure that you are present at the computer terminal when the diagnostic tests are performed.

For more information, see <https://www.dell.com/support/kbdoc/000180971>.

Running the SupportAssist Pre-Boot System Performance Check

Steps

1. Turn on your computer.
2. As the computer boots, press the F12 key as the Dell logo appears.
3. On the boot menu screen, select the **Diagnostics** option.
4. Click the arrow at the bottom left corner.
Diagnostics front page is displayed.
5. Click the arrow in the lower-right corner to go to the page listing.
The items detected are listed.
6. To run a diagnostic test on a specific device, press Esc and click **Yes** to stop the diagnostic test.
7. Select the device from the left pane and click **Run Tests**.
8. If there are any issues, error codes are displayed.
Note the error code and validation number and contact Dell.

Built-in self-test (BIST)

M-BIST

M-BIST (Built In Self-Test) is the system board's built-in self-test diagnostics tool that improves the diagnostics accuracy of system board embedded controller (EC) failures.

NOTE: M-BIST can be manually initiated before POST (Power On Self Test).

How to run M-BIST

NOTE: M-BIST must be initiated on the system from a power-off state either connected to AC power or with battery only.

1. Press and hold both the **M** key on the keyboard and the **power button** to initiate M-BIST.
2. With both the **M** key and the **power button** held down, the battery indicator LED may exhibit two states:
 - a. OFF: No fault detected with the system board
 - b. AMBER: Indicates a problem with the system board
3. If there is a failure with the system board, the battery status LED will flash one of the following error codes for 30 seconds:

Table 22. LED error codes

Blinking Pattern		Possible Problem
Amber	White	
2	1	CPU Failure
2	8	LCD Power Rail Failure
1	1	TPM Detection Failure
2	4	Unrecoverable SPI Failure

4. If there is no failure with the system board, the LCD will cycle through the solid color screens described in the LCD-BIST section for 30 seconds and then power off.

LCD Power rail test (L-BIST)

L-BIST is an enhancement to the single LED error code diagnostics and is automatically initiated during POST. L-BIST will check the LCD power rail. If there is no power being supplied to the LCD (i.e., the L-BIST circuit fails), the battery status LED will flash either an error code [2,8] or an error code [2,7].

NOTE: If L-BIST fails, LCD-BIST cannot function as no power will be supplied to the LCD.

How to invoke L-BIST Test:

1. Press the power button to start the system.
2. If the system does not start up normally, look at the battery status LED:
 - If the battery status LED flashes an error code [2,7], the display cable may not be connected properly.
 - If the battery status LED flashes an error code [2,8], there is a failure on the LCD power rail of the system board, hence there is no power supplied to the LCD.
3. For cases, when a [2,7] error code is shown, check to see if the display cable is properly connected.
4. For cases when a [2,8] error code is shown, replace the system board.

LCD Built-in Self Test (BIST)

Dell laptops have a built-in diagnostic tool that helps you determine if the screen abnormality you are experiencing is an inherent problem with the LCD (screen) of the Dell laptop or with the video card (GPU) and PC settings.

When you notice screen abnormalities like flickering, distortion, clarity issues, fuzzy or blurry image, horizontal or vertical lines, color fade etc., it is always a good practice to isolate the LCD (screen) by running the Built-In Self Test (BIST).

How to invoke LCD BIST Test

1. Power off the Dell laptop.
2. Disconnect any peripherals that are connected to the laptop. Connect only the AC adapter (charger) to the laptop.
3. Ensure that the LCD (screen) is clean (no dust particles on the surface of the screen).
4. Press and hold **D** key and **Power on** the laptop to enter LCD built-in self test (BIST) mode. Continue to hold the D key, until the system boots up.
5. The screen will display solid colors and change colors on the entire screen to white, black, red, green, and blue twice.
6. Then it will display the colors white, black and red.
7. Carefully inspect the screen for abnormalities (any lines, fuzzy color or distortion on the screen).
8. At the end of the last solid color (red), the system will shut down.

NOTE: Dell SupportAssist Pre-boot diagnostics upon launch, initiates an LCD BIST first, expecting a user intervention confirm functionality of the LCD.

System-diagnostic lights

Table 23. System-diagnostic lights

Blinking pattern		Problem description	Suggested resolution
Amber	White		
1	1	TPM detection failure	Replace the system board.
1	2	Unrecoverable SPI Flash Failure	Replace the system board.
1	5	EC unable to program i-Fuse	Replace the system board.

Table 23. System-diagnostic lights (continued)

Blinking pattern		Problem description	Suggested resolution
Amber	White		
1	6	Generic catch-all for ungraceful EC code flow errors	Disconnect all power source (AC, battery, coin cell) and drain flea power by pressing and holding down power button for 3~5 seconds.
2	1	CPU failure	<ul style="list-style-type: none"> • Run the Dell Support Assist/Dell Diagnostics tool. • If problem persists, replace the system board.
2	2	System board failure (included BIOS corruption or ROM error)	<ul style="list-style-type: none"> • Flash latest BIOS version • If problem persists, replace the system board.
2	3	No memory/RAM detected	<ul style="list-style-type: none"> • Confirm that the memory module is installed properly. • If problem persists, replace the memory module.
2	4	Memory/RAM failure	<ul style="list-style-type: none"> • Reset and swap memory modules among the slots. • If problem persists, replace the memory module.
2	5	Invalid memory installed	<ul style="list-style-type: none"> • Reset and swap memory modules among the slots. • If problem persists, replace the memory module.
2	6	System board/Chipset Error	Replace the system board.
2	7	LCD failure (SBIOS message)	Replace the LCD module.
2	8	LCD failure (EC detection of power rail failure)	Replace the system board.
3	1	CMOS battery failure	<ul style="list-style-type: none"> • Reset the main battery connection. • If problem persists, replace the main battery.
3	2	PCI or Video card/chip failure	Replace the system board.
3	3	BIOS Recovery image not found	<ul style="list-style-type: none"> • Flash latest BIOS version • If problem persists, replace the system board.
3	4	BIOS Recovery image found but invalid	<ul style="list-style-type: none"> • Flash latest BIOS version • If problem persists, replace the system board.
3	5	Power rail failure	Replace the system board.
3	6	Flash corruption detected by SBIOS.	<ul style="list-style-type: none"> • Press power button for over 25 seconds to do

Table 23. System-diagnostic lights (continued)

Blinking pattern		Problem description	Suggested resolution
Amber	White		
			RTC reset. If problem persists, replace the system board. <ul style="list-style-type: none"> • Disconnect all power source (AC, battery, coin cell) and drain flea power by pressing and holding down power button 3~5 seconds to ensure all power are drained. • Run "BIOS recovery from USB", and the instructions are in the website Dell support. • If problem persists, replace the system board.
3	7	Timeout waiting on ME to reply to HECI message.	Replace the system board.

NOTE: Blinking 3-3-3 LEDs on Lock LED (Caps-Lock or Num-Lock), Power button LED (without Fingerprint reader), and Diagnostic LED indicates failure to provide input during LCD panel test on Dell SupportAssist Pre-boot System Performance. Check diagnostics.

Recovering the operating system

When your computer is unable to boot to the operating system even after repeated attempts, it automatically starts Dell SupportAssist OS Recovery.

Dell SupportAssist OS Recovery is a standalone tool that is preinstalled in all Dell computers installed with Windows operating system. It consists of tools to diagnose and troubleshoot issues that may occur before your computer boots to the operating system. It enables you to diagnose hardware issues, repair your computer, back up your files, or restore your computer to its factory state.

You can also download it from the Dell Support website to troubleshoot and fix your computer when it fails to boot into their primary operating system due to software or hardware failures.

For more information about the Dell SupportAssist OS Recovery, see *Dell SupportAssist OS Recovery User's Guide* at www.dell.com/serviceabilitytools. Click **SupportAssist** and then, click **SupportAssist OS Recovery**.

Real-Time Clock (RTC Reset)

The Real Time Clock (RTC) reset function allows you or the service technician to recover Dell Latitude systems from No POST/No Power/No Boot situations. The legacy jumper enabled RTC reset has been retired on these models.

Start the RTC reset with the system powered off and connected to AC power. Press and hold the power button for thirty (30) seconds. The system RTC Reset occurs after you release the power button.

Backup media and recovery options

It is recommended to create a recovery drive to troubleshoot and fix problems that may occur with Windows. Dell proposes multiple options for recovering Windows operating system on your Dell PC. For more information, see [Dell Windows Backup Media and Recovery Options](#).

WiFi power cycle

About this task

If your computer is unable to access the internet due to WiFi connectivity issues a WiFi power cycle procedure may be performed. The following procedure provides the instructions on how to conduct a WiFi power cycle:

 **NOTE:** Some ISPs (Internet Service Providers) provide a modem/router combo device.

Steps

1. Turn off your computer.
2. Turn off the modem.
3. Turn off the wireless router.
4. Wait for 30 seconds.
5. Turn on the wireless router.
6. Turn on the modem.
7. Turn on your computer.

Drain residual flea power (perform hard reset)

About this task

Flea power is the residual static electricity that remains in the computer even after it has been powered off and the battery is removed.

For your safety, and to protect the sensitive electronic components in your computer, you are requested to drain residual flea power before removing or replacing any components in your computer.

Draining residual flea power, also known as a performing a "hard reset", is also a common troubleshooting step if your computer does not power on or boot into the operating system.

To drain residual flea power (perform a hard reset)

Steps

1. Turn off your computer.
2. Disconnect the power adapter from your computer.
3. Remove the base cover.
4. Remove the battery.
5. Press and hold the power button for 20 seconds to drain the flea power.
6. Install the battery.
7. Install the base cover.
8. Connect the power adapter to your computer.
9. Turn on your computer.



 **NOTE:** For more information about performing a hard reset, see the knowledge base article [000130881](https://www.dell.com/support) at www.dell.com/support.

Getting help and contacting Dell

Self-help resources

You can get information and help on Dell products and services using these self-help resources:

Table 24. Self-help resources

Self-help resources	Resource location
Information about Dell products and services	www.dell.com
My Dell app	
Tips	
Contact Support	In Windows search, type <code>Contact Support</code> , and press Enter.
Online help for operating system	www.dell.com/support/windows
Access top solutions, diagnostics, drivers and downloads, and learn more about your computer through videos, manuals and documents.	Your Dell computer is uniquely identified by a Service Tag or Express Service Code. To view relevant support resources for your Dell computer, enter the Service Tag or Express Service Code at www.dell.com/support . For more information on how to find the Service Tag for your computer, see Locate the Service Tag on your computer .
Dell knowledge base articles for a variety of computer concerns	<ol style="list-style-type: none"> 1. Go to www.dell.com/support. 2. On the menu bar at the top of the Support page, select Support > Knowledge Base. 3. In the Search field on the Knowledge Base page, type the keyword, topic, or model number, and then click or tap the search icon to view the related articles.

Contacting Dell

To contact Dell for sales, technical support, or customer service issues, see www.dell.com/contactdell.

 **NOTE:** Availability varies by country/region and product, and some services may not be available in your country/region.

 **NOTE:** If you do not have an active Internet connection, you can find contact information about your purchase invoice, packing slip, bill, or Dell product catalog.