

Precision 5480

Service Manual

Notes, cautions, and warnings

 **NOTE:** A NOTE indicates important information that helps you make better use of your product.

 **CAUTION:** A CAUTION indicates either potential damage to hardware or loss of data and tells you how to avoid the problem.

 **WARNING:** A WARNING indicates a potential for property damage, personal injury, or death.

Chapter 1: Working inside your computer	6
Safety instructions.....	6
Before working inside your computer.....	6
Safety precautions.....	7
Electrostatic discharge—ESD protection.....	7
ESD field service kit	8
Transporting sensitive components.....	9
After working inside your computer.....	9
BitLocker.....	9
Chapter 2: Removing and installing components	10
Recommended tools.....	10
Screw list.....	10
Major components of Precision 5480.....	11
Base cover.....	13
Removing the base cover.....	13
Installing the base cover.....	15
Battery.....	17
Lithium-ion battery precautions.....	17
Removing the battery.....	18
Installing the battery.....	19
M.2 solid-state drive.....	20
Removing the M.2 2230 solid state drive.....	20
Installing the M.2 2230 solid state drive.....	21
Removing the M.2 2280 solid state drive.....	23
Installing the M.2 2280 solid state drive.....	23
Left fan.....	24
Removing the left fan.....	24
Installing the left fan.....	25
Right fan.....	26
Removing the right fan.....	26
Installing the right fan.....	27
Heat sink.....	29
Removing the heat sink for integrated graphics.....	29
Installing the heat sink for integrated graphics.....	29
Removing the heat sink for discrete graphics.....	30
Installing the heat sink for discrete graphics.....	31
Audio jack.....	32
Removing the audio jack.....	32
Installing the audio jack.....	33
Speakers.....	34
Removing the speaker.....	34
Installing the speaker.....	35
Smart-card reader.....	37

Removing the smart-card reader.....	37
Installing the smart-card reader.....	37
Display assembly.....	38
Removing the display assembly.....	38
Installing the display assembly.....	41
System board.....	43
Removing the system board.....	43
Installing the system board.....	46
Power button with fingerprint reader.....	49
Removing the power-button board with fingerprint reader.....	49
Installing the power-button board with fingerprint reader.....	50
USH board.....	51
Removing the USH daughter-board.....	51
Installing the USH daughter-board.....	52
WLAN antennas.....	53
Removing the WLAN antennas.....	53
Installing the WLAN antennas.....	54
Palm-rest and keyboard assembly.....	56
Removing the palm-rest and keyboard assembly.....	56
Installing the palm-rest and keyboard assembly.....	57
Chapter 3: Drivers and downloads.....	58
Chapter 4: BIOS setup.....	59
BIOS overview.....	59
Entering BIOS setup program.....	59
Navigation keys.....	59
One Time Boot menu.....	60
BIOS setup options.....	60
Updating the BIOS.....	71
Updating the BIOS in Windows.....	71
Updating the BIOS in Linux and Ubuntu.....	71
Updating the BIOS using the USB drive in Windows.....	71
Updating the BIOS from the F12 One-Time boot menu.....	72
System and setup password.....	73
Assigning a system setup password.....	73
Deleting or changing an existing system setup password.....	73
Clearing BIOS (System Setup) and System passwords.....	74
Chapter 5: Troubleshooting.....	75
Handling swollen Lithium-ion batteries.....	75
Dell SupportAssist Pre-boot System Performance Check diagnostics.....	75
Running the SupportAssist Pre-Boot System Performance Check.....	76
Built-in self-test (BIST).....	76
M-BIST.....	76
LCD Power rail test (L-BIST).....	77
LCD Built-in Self Test (BIST).....	77
System-diagnostic lights.....	77
Real-Time Clock (RTC Reset).....	79











Recovering the operating system.....79
Backup media and recovery options..... 79
Wi-Fi power cycle..... 80
Drain residual flea power (perform hard reset)..... 80

Chapter 6: Getting help and contacting Dell.....81

Working inside your computer

Safety instructions

Use the following safety guidelines to protect your computer from potential damage and to ensure your personal safety. Unless otherwise noted, each procedure included in this document assumes that you have read the safety information that shipped with your computer.

-  **WARNING:** Before working inside your computer, read the safety information that is shipped with your computer. For more safety best practices, see the Regulatory Compliance home page at www.dell.com/regulatory_compliance.
-  **WARNING:** Disconnect your computer from all power sources before opening the computer cover or panels. After you finish working inside the computer, replace all covers, panels, and screws before connecting your computer to an electrical outlet.
-  **CAUTION:** To avoid damaging the computer, ensure that the work surface is flat, dry, and clean.
-  **CAUTION:** To avoid damaging the components and cards, handle them by their edges, and avoid touching the pins and the contacts.
-  **CAUTION:** You should only perform troubleshooting and repairs as authorized or directed by the Dell technical assistance team. Damage due to servicing that is not authorized by Dell is not covered by your warranty. See the safety instructions that is shipped with the product or at www.dell.com/regulatory_compliance.
-  **CAUTION:** Before touching anything inside your computer, ground yourself by touching an unpainted metal surface, such as the metal at the back of the computer. While you work, periodically touch an unpainted metal surface to dissipate static electricity which could harm internal components.
-  **CAUTION:** When you disconnect a cable, pull it by its connector or its pull tab, not the cable itself. Some cables have connectors with locking tabs or thumbscrews that you must disengage before disconnecting the cable. When disconnecting cables, keep them evenly aligned to avoid bending the connector pins. When connecting cables, ensure that the ports and the connectors are correctly oriented and aligned.
-  **CAUTION:** Press and eject any installed card from the media-card reader.
-  **CAUTION:** Exercise caution when handling Lithium-ion batteries in laptops. Swollen batteries should not be used and should be replaced and disposed properly.
-  **NOTE:** The color of your computer and certain components may appear differently than shown in this document.

Before working inside your computer

About this task

-  **NOTE:** The images in this document may differ from your computer depending on the configuration you ordered.

Steps

1. Save and close all open files and exit all open applications.
2. Shut down your computer. For Windows operating system, click **Start** >  **Power** > **Shut down**.

 **NOTE:** If you are using a different operating system, see the documentation of your operating system for shut-down instructions.

3. Disconnect your computer and all attached devices from their electrical outlets.
4. Disconnect all attached network devices and peripherals, such as keyboard, mouse, and monitor from your computer.

 **CAUTION:** To disconnect a network cable, first unplug the cable from your computer and then unplug the cable from the network device.

5. Remove any media card and optical disc from your computer, if applicable.

Safety precautions

The safety precautions chapter details the primary steps to be taken before performing any disassembly instructions.

Observe the following safety precautions before you perform any installation or break/fix procedures involving disassembly or reassembly:

- Turn off the system and all attached peripherals.
- Disconnect the system and all attached peripherals from AC power.
- Disconnect all network cables, telephone, and telecommunications lines from the system.
- Use an ESD field service kit when working inside any tablet/notebook/desktop to avoid electrostatic discharge (ESD) damage.
- After removing any system component, carefully place the removed component on an anti-static mat.
- Wear shoes with non-conductive rubber soles to reduce the chance of getting electrocuted.

Standby power

Dell products with standby power must be unplugged before you open the case. Systems that incorporate standby power are essentially powered while turned off. The internal power enables the system to be remotely turned on (wake on LAN) and suspended into a sleep mode and has other advanced power management features.

Unplugging, pressing, and holding the power button for 15 seconds should discharge residual power in the system board.

Bonding

Bonding is a method for connecting two or more grounding conductors to the same electrical potential. This is done through the use of a field service electrostatic discharge (ESD) kit. When connecting a bonding wire, ensure that it is connected to bare metal and never to a painted or non-metal surface. The wrist strap should be secure and in full contact with your skin, and ensure that you remove all jewelry such as watches, bracelets, or rings prior to bonding yourself and the equipment.

Electrostatic discharge—ESD protection

ESD is a major concern when you handle electronic components, especially sensitive components such as expansion cards, processors, memory DIMMs, and system boards. Very slight charges can damage circuits in ways that may not be obvious, such as intermittent problems or a shortened product life span. As the industry pushes for lower power requirements and increased density, ESD protection is an increasing concern.

Due to the increased density of semiconductors used in recent Dell products, the sensitivity to static damage is now higher than in previous Dell products. For this reason, some previously approved methods of handling parts are no longer applicable.

Two recognized types of ESD damage are catastrophic and intermittent failures.

- **Catastrophic** – Catastrophic failures represent approximately 20 percent of ESD-related failures. The damage causes an immediate and complete loss of device functionality. An example of catastrophic failure is a memory DIMM that has received a static shock and immediately generates a "No POST/No Video" symptom with a beep code emitted for missing or nonfunctional memory.
- **Intermittent** – Intermittent failures represent approximately 80 percent of ESD-related failures. The high rate of intermittent failures means that most of the time when damage occurs, it is not immediately recognizable. The DIMM receives a static shock, but the tracing is merely weakened and does not immediately produce outward symptoms related to the damage. The weakened trace may take weeks or months to melt, and in the meantime may cause degradation of memory integrity, intermittent memory errors, etc.

The more difficult type of damage to recognize and troubleshoot is the intermittent (also called latent or "walking wounded") failure.

Perform the following steps to prevent ESD damage:

- Use a wired ESD wrist strap that is properly grounded. The use of wireless anti-static straps is no longer allowed; they do not provide adequate protection. Touching the chassis before handling parts does not ensure adequate ESD protection on parts with increased sensitivity to ESD damage.
- Handle all static-sensitive components in a static-safe area. If possible, use anti-static floor pads and workbench pads.
- When unpacking a static-sensitive component from its shipping carton, do not remove the component from the anti-static packing material until you are ready to install the component. Before unwrapping the anti-static packaging, ensure that you discharge static electricity from your body.
- Before transporting a static-sensitive component, place it in an anti-static container or packaging.

ESD field service kit

The unmonitored Field Service kit is the most commonly used service kit. Each Field Service kit includes three main components: anti-static mat, wrist strap, and bonding wire.

Components of an ESD field service kit

The components of an ESD field service kit are:

- **Anti-Static Mat** – The anti-static mat is dissipative and parts can be placed on it during service procedures. When using an anti-static mat, your wrist strap should be snug and the bonding wire should be connected to the mat and to any bare metal on the system being worked on. Once deployed properly, service parts can be removed from the ESD bag and placed directly on the mat. ESD-sensitive items are safe in your hand, on the ESD mat, in the system, or inside a bag.
- **Wrist Strap and Bonding Wire** – The wrist strap and bonding wire can be either directly connected between your wrist and bare metal on the hardware if the ESD mat is not required, or connected to the anti-static mat to protect hardware that is temporarily placed on the mat. The physical connection of the wrist strap and bonding wire between your skin, the ESD mat, and the hardware is known as bonding. Use only Field Service kits with a wrist strap, mat, and bonding wire. Never use wireless wrist straps. Always be aware that the internal wires of a wrist strap are prone to damage from normal wear and tear, and must be checked regularly with a wrist strap tester in order to avoid accidental ESD hardware damage. It is recommended to test the wrist strap and bonding wire at least once per week.
- **ESD Wrist Strap Tester** – The wires inside of an ESD strap are prone to damage over time. When using an unmonitored kit, it is a best practice to regularly test the strap prior to each service call, and at a minimum, test once per week. A wrist strap tester is the best method for doing this test. If you do not have your own wrist strap tester, check with your regional office to find out if they have one. To perform the test, plug the wrist-strap's bonding-wire into the tester while it is strapped to your wrist and push the button to test. A green LED is lit if the test is successful; a red LED is lit and an alarm sounds if the test fails.
- **Insulator Elements** – It is critical to keep ESD sensitive devices, such as plastic heat sink casings, away from internal parts that are insulators and often highly charged.
- **Working Environment** – Before deploying the ESD Field Service kit, assess the situation at the customer location. For example, deploying the kit for a server environment is different than for a desktop or portable environment. Servers are typically installed in a rack within a data center; desktops or portables are typically placed on office desks or cubicles. Always look for a large open flat work area that is free of clutter and large enough to deploy the ESD kit with additional space to accommodate the type of system that is being repaired. The workspace should also be free of insulators that can cause an ESD event. On the work area, insulators such as Styrofoam and other plastics should always be moved at least 12 inches or 30 centimeters away from sensitive parts before physically handling any hardware components
- **ESD Packaging** – All ESD-sensitive devices must be shipped and received in static-safe packaging. Metal, static-shielded bags are preferred. However, you should always return the damaged part using the same ESD bag and packaging that the new part arrived in. The ESD bag should be folded over and taped shut and all the same foam packing material should be used in the original box that the new part arrived in. ESD-sensitive devices should be removed from packaging only at an ESD-protected work surface, and parts should never be placed on top of the ESD bag because only the inside of the bag is shielded. Always place parts in your hand, on the ESD mat, in the system, or inside an anti-static bag.
- **Transporting Sensitive Components** – When transporting ESD sensitive components such as replacement parts or parts to be returned to Dell, it is critical to place these parts in anti-static bags for safe transport.

ESD protection summary

It is recommended to use the traditional wired ESD grounding wrist strap and protective anti-static mat at all times when servicing Dell products. In addition, it is critical to keep sensitive parts separate from all insulator parts while performing service and that they use anti-static bags for transporting sensitive components.

Transporting sensitive components

When transporting ESD sensitive components such as replacement parts or parts to be returned to Dell, it is critical to place these parts in anti-static bags for safe transport.

After working inside your computer

About this task

 **NOTE:** Leaving stray or loose screws inside your computer may severely damage your computer.

Steps

1. Replace all screws and ensure that no stray screws remain inside your computer.
2. Connect any external devices, peripherals, or cables you removed before working on your computer.
3. Replace any media cards, discs, or any other parts that you removed before working on your computer.
4. Connect your computer and all attached devices to their electrical outlets.
5. Turn on your computer.

BitLocker

 **CAUTION:** If BitLocker is not suspended before updating the BIOS, the next time you reboot the system it will not recognize the BitLocker key. You will then be prompted to enter the recovery key to progress, and the system will ask for this on each reboot. If the recovery key is not known this can result in data loss or an unnecessary operating system reinstall. For more information about this subject, see Knowledge Article: [updating the BIOS on Dell systems with BitLocker enabled](#).

The installation of the following components triggers BitLocker:

- Hard disk drive or solid state drive
- System board

Removing and installing components

NOTE: The images in this document may differ from your computer depending on the configuration you ordered.

Recommended tools

The procedures in this document may require the following tools:

- Phillips screwdriver #0
- Phillips screwdriver #1
- Torx #5 (T5) screwdriver
- Plastic scribe

Screw list

NOTE: When removing screws from a component, it is recommended to note the screw type, the quantity of screws, and then place them in a screw storage box. This is to ensure that the correct number of screws and correct screw type is restored when the component is replaced.

NOTE: Some computers have magnetic surfaces. Ensure that the screws are not left attached to such surfaces when replacing a component.

NOTE: Screw color may vary with the configuration ordered.

Table 1. Screw list





















Component	Screw type	Quantity	Screw image
Base cover	T5, M2x3	8	
M.2 2230 solid state drive NOTE: For computers shipped with M.2 2230 solid state drive.	M2x2	2	
M.2 2280 solid state drive NOTE: For computers shipped with M.2 2280 solid state drive.	M2x2	1	
Battery	M2x4	5	
Left fan	M2x4	2	
Right fan	M2x4	2	

Table 1. Screw list (continued)

Component	Screw type	Quantity	Screw image
Heat-sink for integrated graphics	Captive screw	4	
Heat-sink for discrete graphics	Captive screw	5	
Audio jack	M2x4 M1.6x3	3 1	 
Speakers	M1.6x1.8	2	
Smart-card reader	M1.6x1.7	2	
Display assembly	M2.5x5 T5, M1.4x4	6 4	 
System board	M2x4 T5, M1.4x4 M1.6x2.3	6 4 1	  
Power button board with fingerprint reader	M1.6x2	3	
USH board	M1.4x1.2	2	
WLAN antennas	M1.4x2.5	4	

Major components of Precision 5480

The following image shows the major components of Precision 5480.

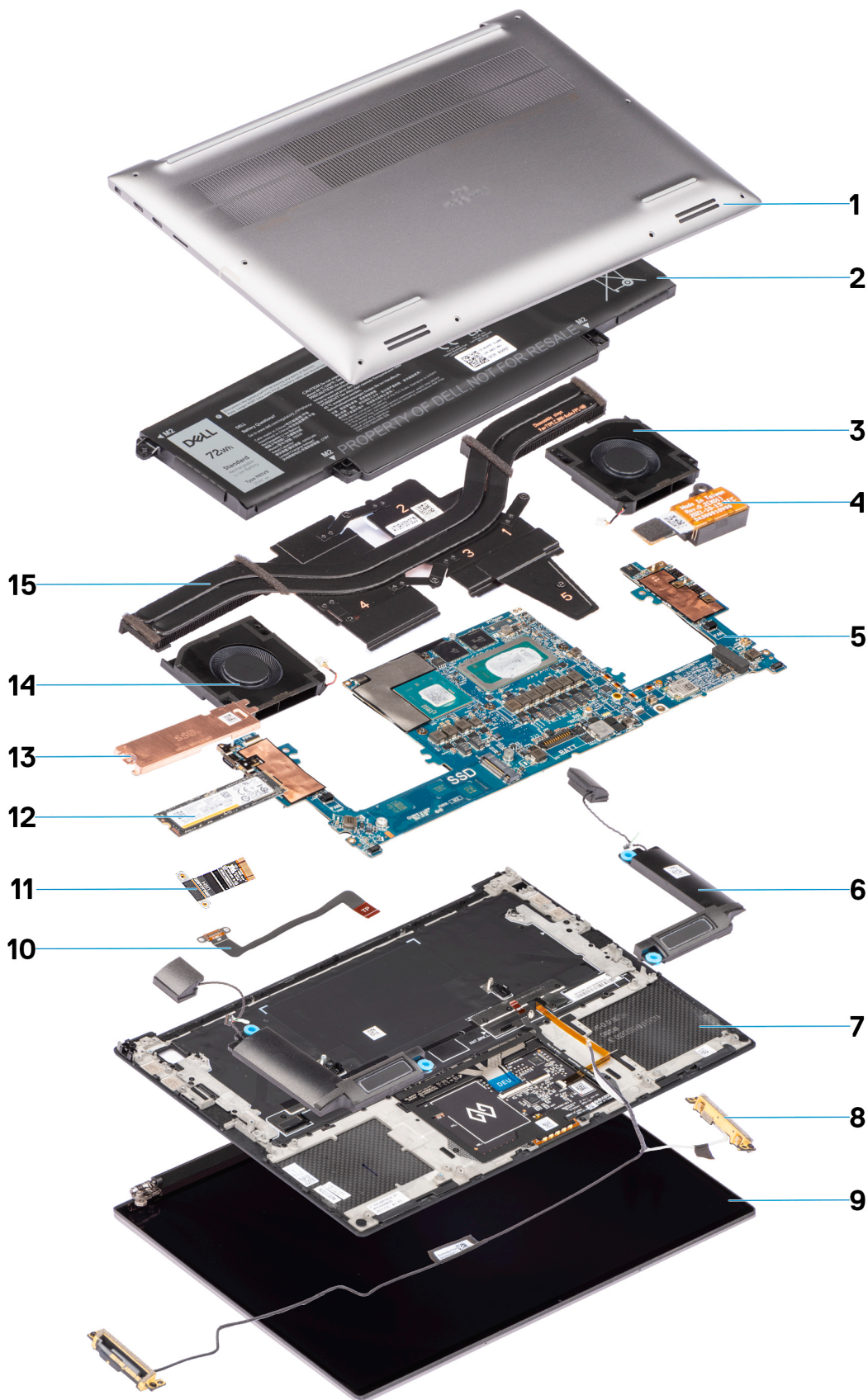

- 1. Base cover
- 3. Right fan
- 5. System board
- 7. Palm-rest

- 2. Battery
- 4. Audio jack
- 6. Speakers
- 8. WLAN antennas

- 9. Display assembly
- 10. Touchpad flat printed cable
- 11. USH daughter-board flat printed cable
- 12. Solid-state drive
- 13. Solid-state drive shield
- 14. Left fan
- 15. Heat sink

NOTE: Dell provides a list of components and their part numbers for the original system configuration purchased. These parts are available according to warranty coverages purchased by the customer. Contact your Dell sales representative for purchase options.

Base cover

Removing the base cover

Prerequisites

1. Follow the procedure in [before working inside your computer](#).

About this task

The figure indicates the location of the base cover and provides a visual representation of the removal procedure.



8x
T5 M2x3





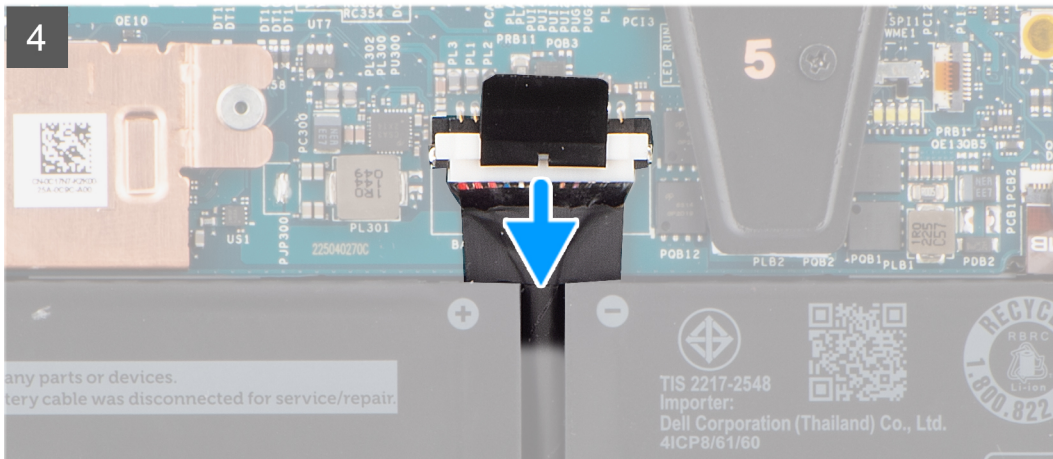
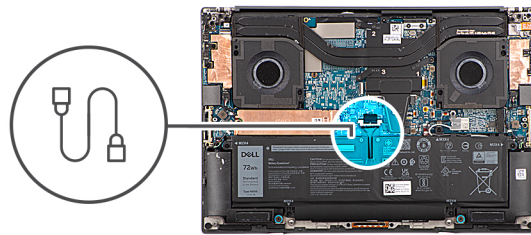

Steps

1. Remove the eight (T5, M2x3) torx screws that secure the base cover to the computer.
2. Use a scribe to pry from the gap at the bottom-left corner of the base cover. Then slide the scribe towards the middle of bottom side, and then the left side of the system to disengage the clips. Repeat the same process for the other side of the system.
 - NOTE:** Do not pry up from the top side (near the vents) of the base cover as it can damage the rear side of the cover.
 - CAUTION:** Only use the plastic scribe to disengage and release the clips with the prying motion along the edges of the base cover. Do not use your fingers.
3. Lift the base cover starting from the bottom edge and push it towards the rear to remove it from the computer.
4. Disconnect the battery cable from the connector on the system board.
 - NOTE:** Pull the pull tab vertically to disconnect the battery cable.

Installing the base cover

Prerequisites

If you are replacing a component, remove the existing component before performing the installation procedure.

About this task

The figure indicates the location of the base cover and provides a visual representation of the installation procedure.

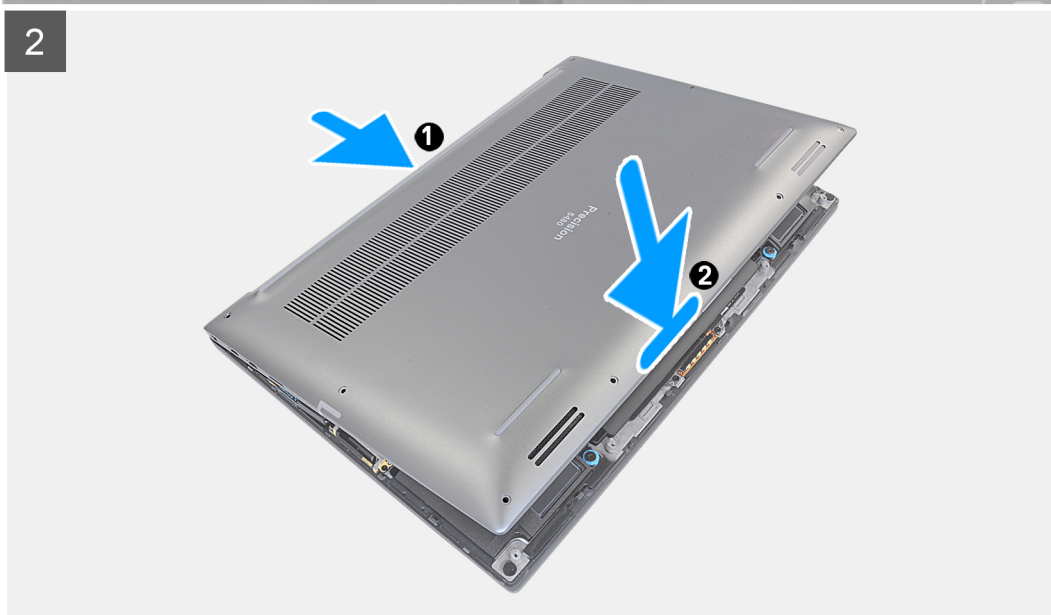
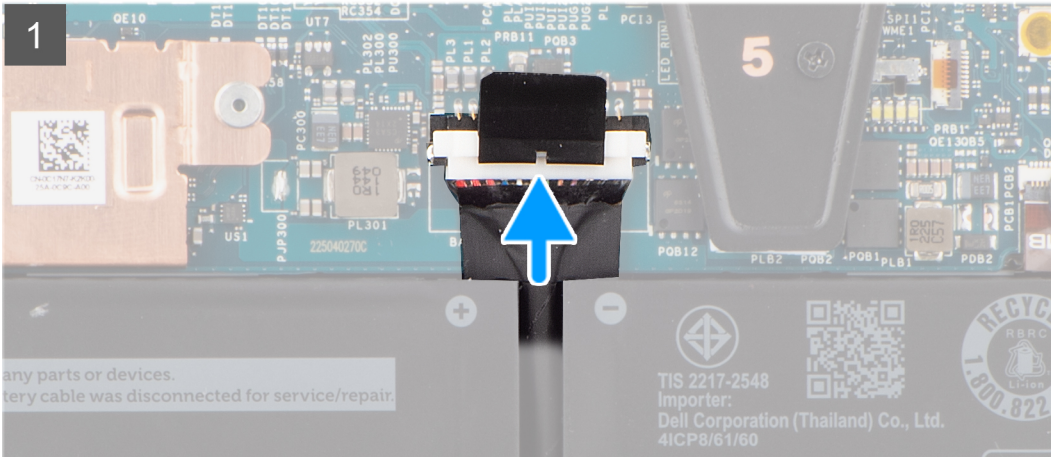
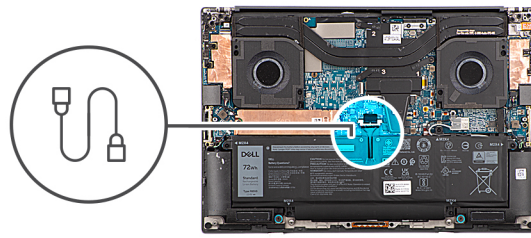



8x
T5 M2x3

3



Steps

1. Connect the battery cable to the connector on the system board.
2. Slide the base cover into its slot until it clicks into place and replace the eight (T5, M2x3) torx screws to secure the base cover to the computer.

Next steps

1. Follow the procedure in [after working inside your computer](#).

Battery

Lithium-ion battery precautions

⚠ CAUTION:

- Exercise caution when handling Lithium-ion batteries.
- Discharge the battery completely before removing it. Disconnect the AC power adapter from the system and operate the computer solely on battery power—the battery is fully discharged when the computer no longer turns on when the power button is pressed.
- Do not crush, drop, mutilate, or penetrate the battery with foreign objects.
- Do not expose the battery to high temperatures, or disassemble battery packs and cells.
- Do not apply pressure to the surface of the battery.

- Do not bend the battery.
- Do not use tools of any kind to pry on or against the battery.
- Ensure any screws during the servicing of this product are not lost or misplaced, to prevent accidental puncture or damage to the battery and other system components.
- If the battery gets stuck inside your computer as a result of swelling, do not try to release it as puncturing, bending, or crushing a lithium-ion battery can be dangerous. In such an instance, contact Dell technical support for assistance. See www.dell.com/contactdell.
- Always purchase genuine batteries from www.dell.com or authorized Dell partners and resellers.
- Swollen batteries should not be used and should be replaced and disposed properly. For guidelines on how to handle and replace swollen Lithium-ion batteries, see [Handling swollen Lithium-ion batteries](#).

Removing the battery

Prerequisites

1. Follow the procedure in [Before working inside your computer](#).
2. Remove the [base cover](#).

About this task

The figure indicates the location of the battery and provides a visual representation of the removal procedure.

NOTE: For models shipped with WLAN antennas, unroute the cables from the top-right side of the battery before battery removal and then tuck the cables back into the routing channels when re-installing the battery.

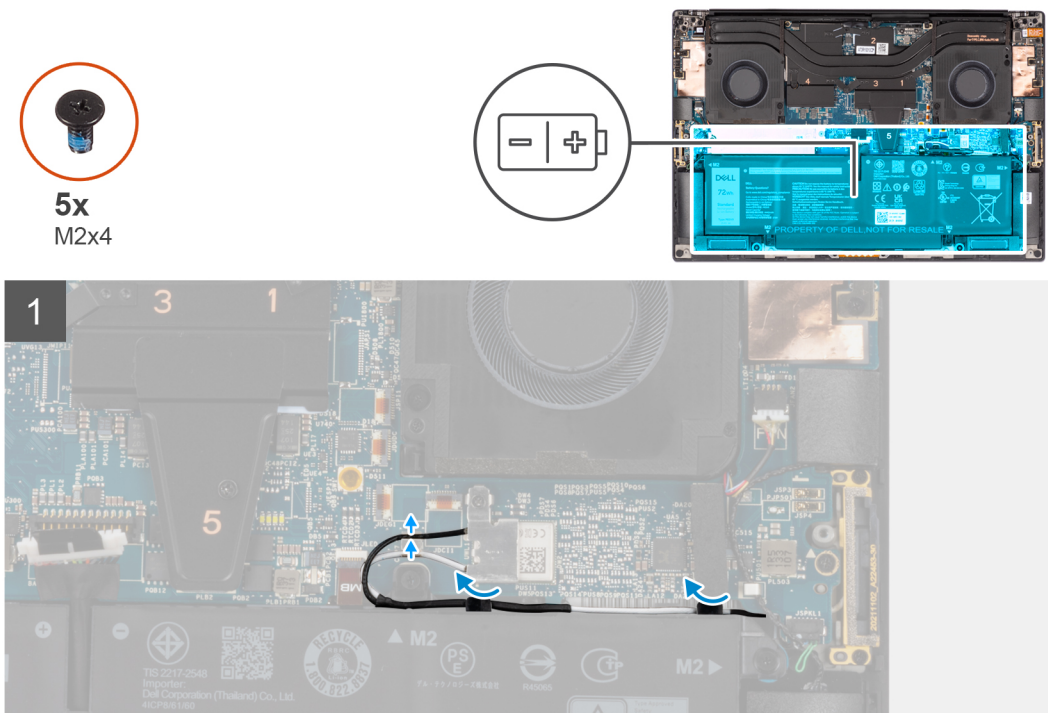



Steps

1. Unroute the WLAN antennas from the routing guides on the battery.
2. Remove the five (M2x4) screws that secure the battery to the palm-rest and keyboard assembly.
3. Slightly lift the battery at an angle and slide to remove from the palm-rest and keyboard assembly.

Installing the battery

Prerequisites

If you are replacing a component, remove the existing component before performing the installation procedure.

About this task

The figure indicates the location of the battery and provides a visual representation of the installation procedure.

NOTE: For models shipped with WLAN antennas, unroute the cables from the top-right side of the battery before battery removal and then tuck the cables back into the routing channels when re-installing the battery.

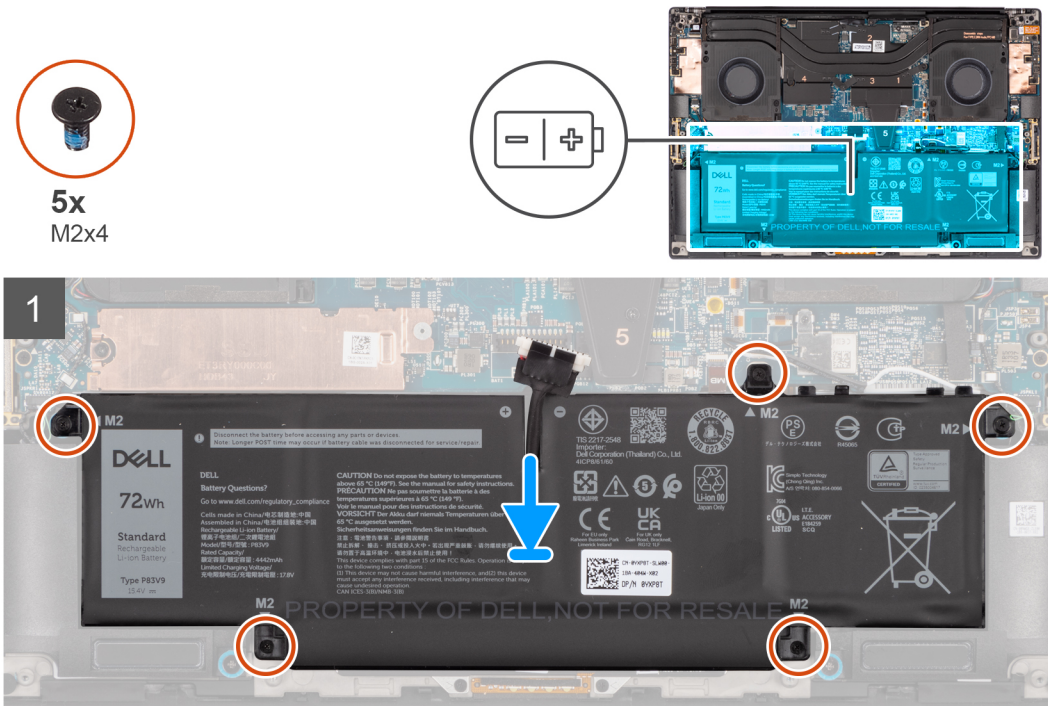

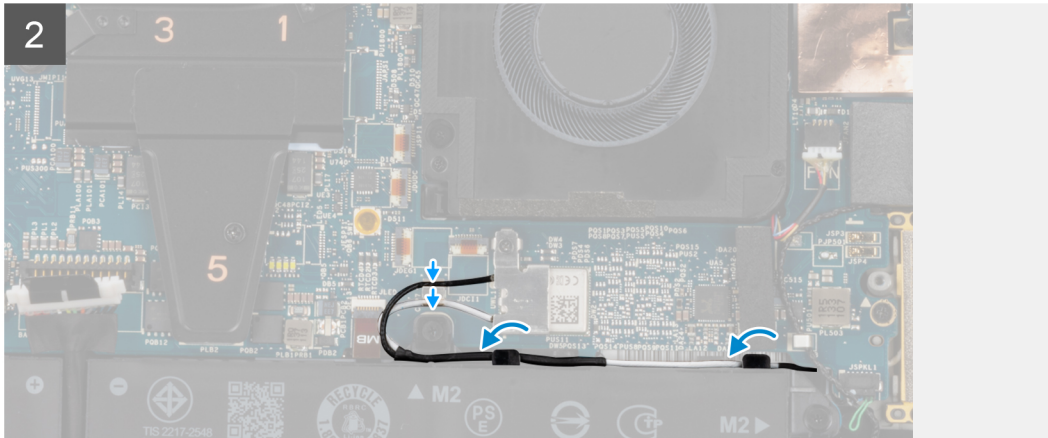

Steps

1. Place the battery onto its slot in the palm-rest and keyboard assembly.
2. Replace the five (M2x4) screws that secure the battery to the palm-rest and keyboard assembly.
3. Route the WLAN antennas using the routing guides on the battery.

Next steps

1. Install the [base cover](#).
2. Follow the procedure in [After working inside your computer](#).

M.2 solid-state drive

Removing the M.2 2230 solid state drive

Prerequisites

 **NOTE:** For computers shipped with M.2 2230 solid state drive.

1. Follow the procedure in [Before working inside your computer](#).
2. Remove the [base cover](#).

About this task

The figure indicates the location of the M.2 2230 solid state drive and provides a visual representation of the removal procedure.



2x
M2x2

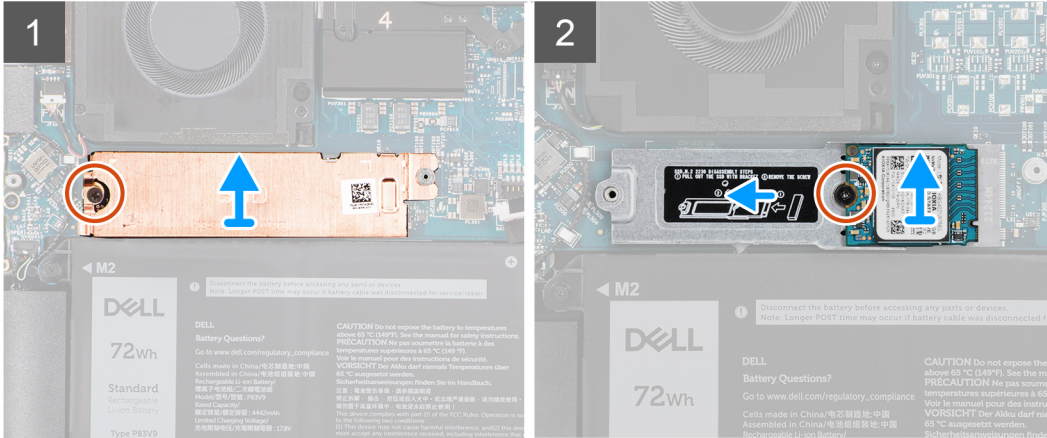
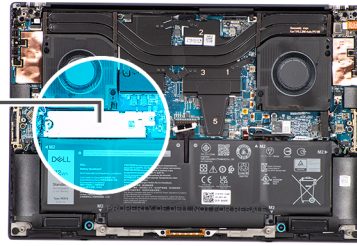

Steps

1. Remove the (M2x2) screw that secures the SSD thermal plate to the M.2 2230 solid state drive bracket.
2. Lift to remove the SSD thermal plate away from the computer.
3. Remove the (M2x2) screw that secures the M.2 2230 solid state drive to the M.2 2230 solid state drive bracket.
4. Lift the M.2 2230 solid state drive bracket at an angle and slide to remove from its slot on the system board.
5. Lift to remove M.2 2230 solid state drive from the M.2 2230 solid state drive bracket.

Installing the M.2 2230 solid state drive

Prerequisites

i **NOTE:** For computers shipped with M.2 2230 solid state drive.

If you are replacing a component, remove the existing component before performing the installation procedure.

About this task

The figure indicates the location of the M.2 2230 solid state drive and provides a visual representation of the installation procedure.



2x
M2x2

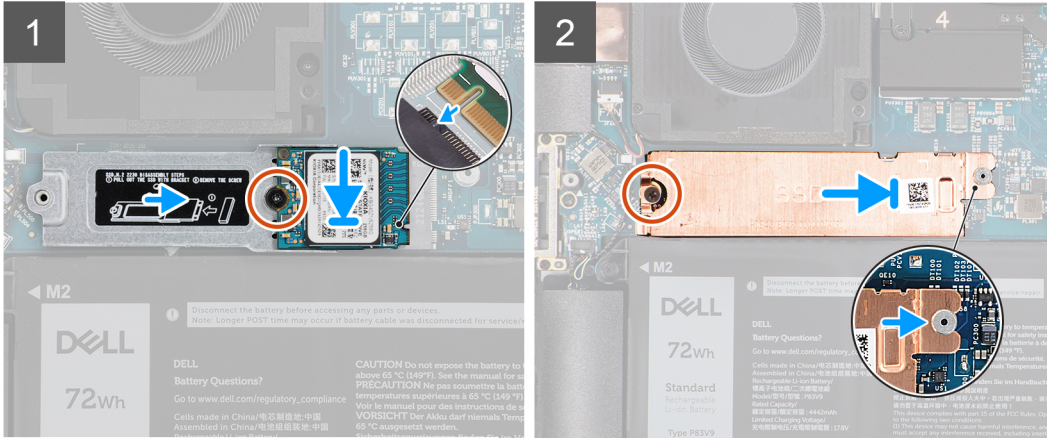
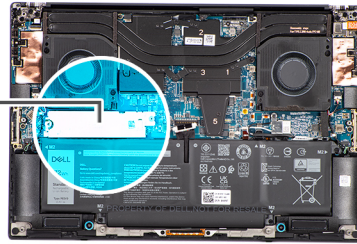

Steps

1. Align and place the M.2 2230 solid state drive on the M.2 2230 solid state drive bracket.

i NOTE: Install the M.2 2230 solid state drive to the SSD bracket so that the top side (with the sticker) of the M.2 2230 solid state drive is facing up.



2. Replace the (M2x2) screw that secures the M.2 2230 solid state drive to the M.2 2230 solid state drive bracket.
3. Carefully align and insert the M.2 2230 solid state drive bracket to its slot on the system board.
4. Slide the thermal plate into place over the SSD so that the tab on the plate is inserted into the securing peg on the system board.
5. Replace the (M2x2) screw that secures the SSD thermal plate to the M.2 2230 solid state drive bracket.

Next steps

1. Install the [base cover](#).
2. Follow the procedure in [After working inside your computer](#).

Removing the M.2 2280 solid state drive

Prerequisites

NOTE: For computers shipped with M.2 2280 solid state drive.

1. Follow the procedure in [Before working inside your computer](#).
2. Remove the [base cover](#).

About this task

The figure indicates the location of the M.2 2280 solid state drive and provides a visual representation of the removal procedure.

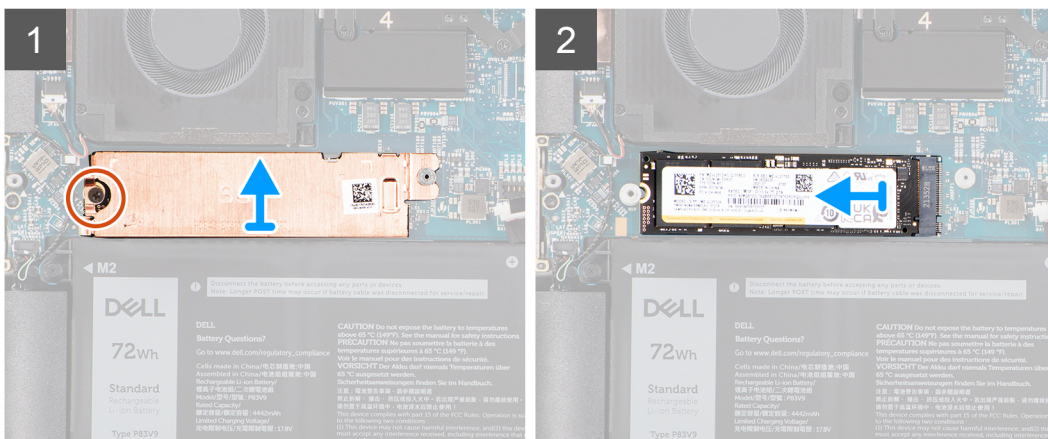

Steps

1. Remove the (M2x2) screw that secures the SSD thermal plate to the M.2 2280 solid state drive.
2. Lift to remove the SSD thermal plate away from the computer.
3. Lift the M.2 2280 solid state drive at an angle and slide to remove from its slot on the system board.

Installing the M.2 2280 solid state drive

Prerequisites

NOTE: For computers shipped with M.2 2280 solid state drive.

If you are replacing a component, remove the existing component before performing the installation procedure.

About this task

The figure indicates the location of the M.2 2280 solid state drive and provides a visual representation of the installation procedure.

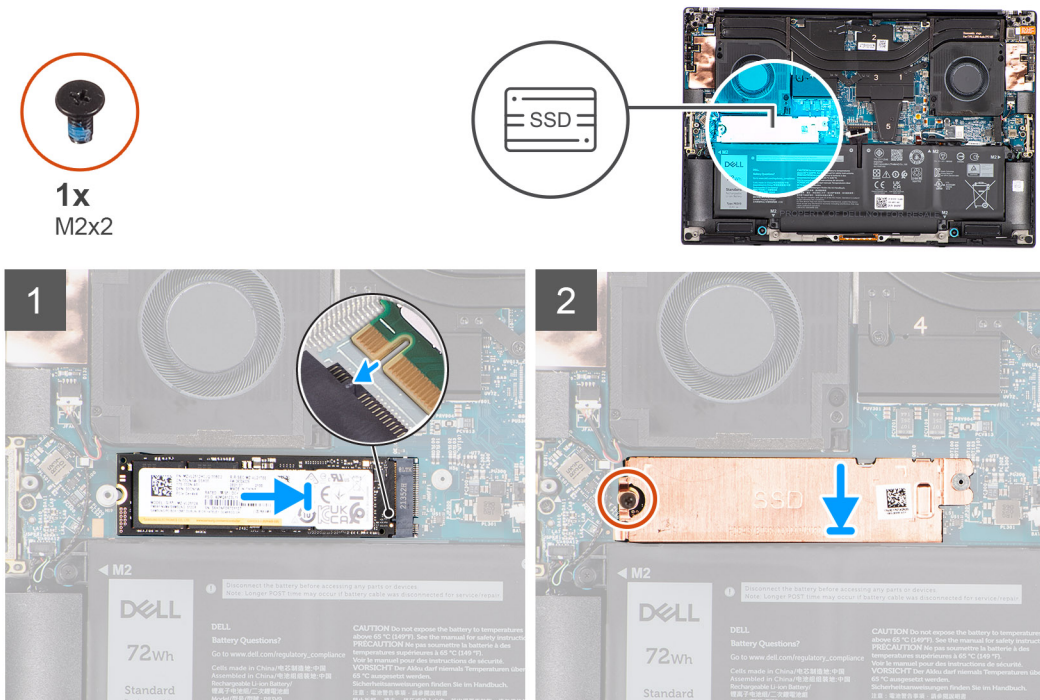

Steps

1. Carefully align and insert the M.2 2280 solid state drive to its slot on the system board.
2. Replace the (M2x2) screw that secures the SSD thermal plate to the M.2 2280 solid state drive.

Next steps

1. Install the [base cover](#).
2. Follow the procedure in [After working inside your computer](#).

Left fan

Removing the left fan

Prerequisites

1. Follow the procedure in [Before working inside your computer](#).
2. Remove the [base cover](#).

About this task

The following images indicate the location of the left fan and provide a visual representation of the removal procedure.



2x
M2x4

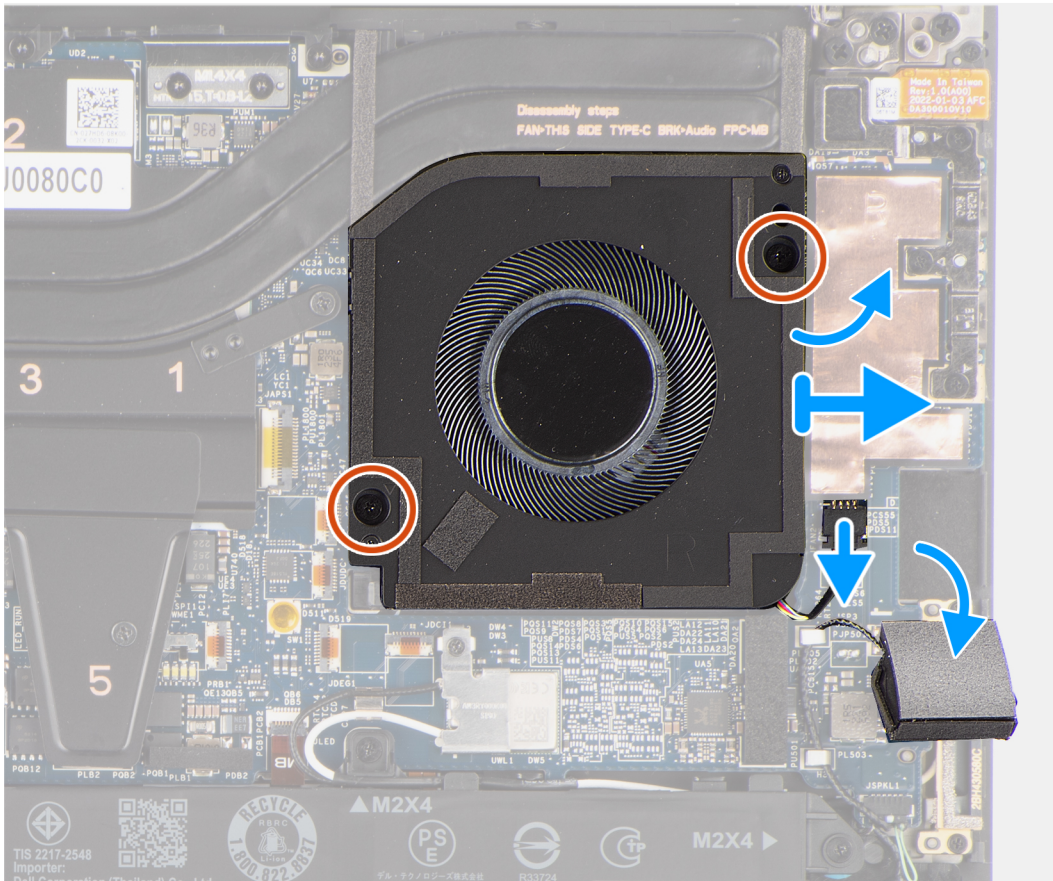
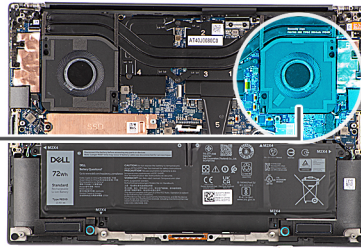
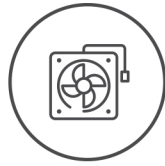

Steps

1. Carefully peel off the tweeter speaker from its compartment next to the fan connector to create more space to disconnect the fan cable.
2. Disconnect the left fan cable from the system board.
3. Remove the two (M2x4) screws that secure the left fan to the palm-rest and keyboard assembly.
4. Lift the fan from its outer edge and slide it away from the palm-rest and keyboard assembly.

Installing the left fan

Prerequisites

If you are replacing a component, remove the existing component before performing the installation procedure.

About this task

The following images indicate the location of the left fan and provide a visual representation of the installation procedure.



2x
M2x4

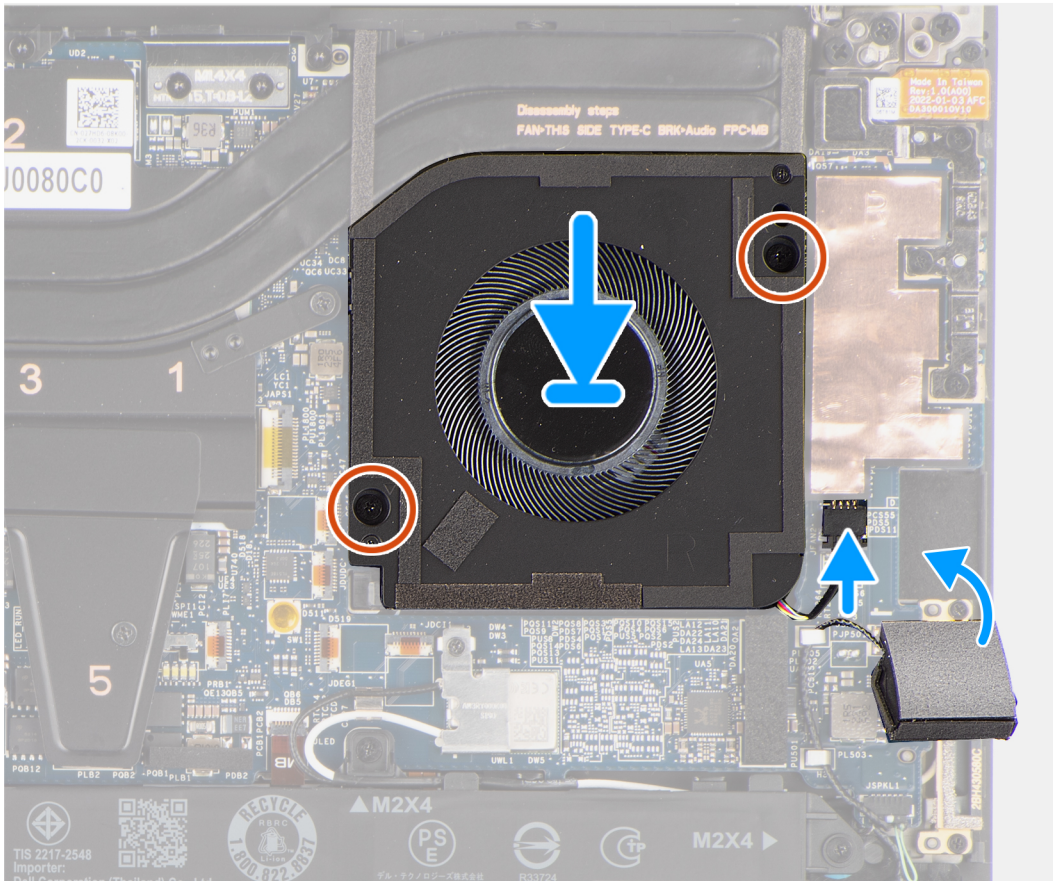
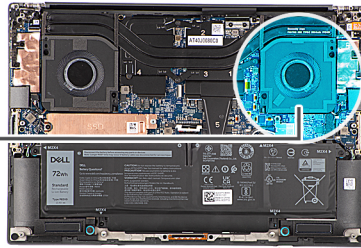
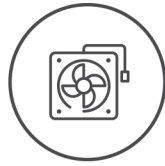

Steps

1. Align the screw holes on left fan with the screw holes on the palm-rest and keyboard assembly.
2. Replace the two (M2x4) screws that secure the left fan to the palm-rest and keyboard assembly.
3. Connect the left fan cable to the system board.
4. Adhere the tweeter speaker in its compartment on the palm-rest and keyboard assembly.

Next steps

1. Install the [base cover](#).
2. Follow the procedure in [After working inside your computer](#).

Right fan

Removing the right fan

Prerequisites

1. Follow the procedure in [Before working inside your computer](#).

2. Remove the [base cover](#).

About this task

The following images indicate the location of the right fan and provide a visual representation of the removal procedure.



2x
M2x4

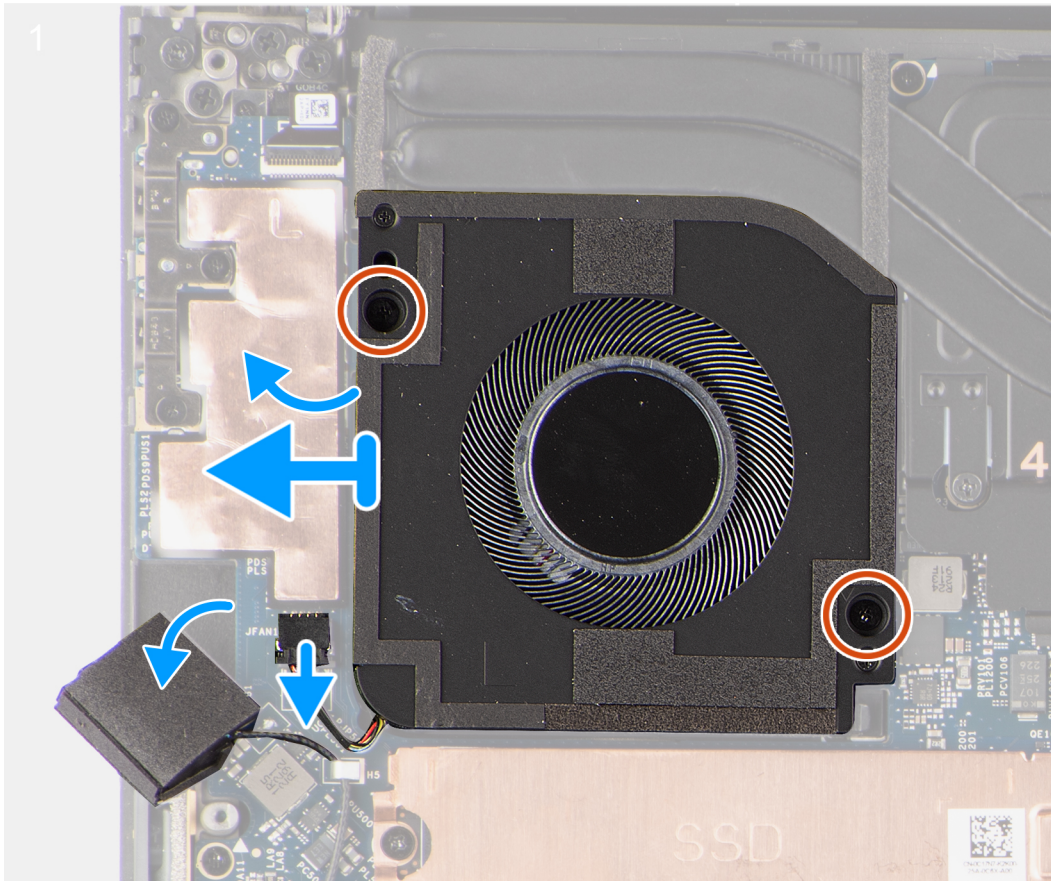
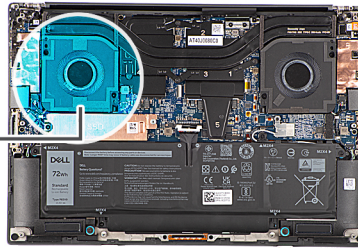
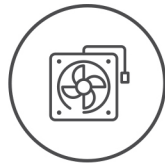

Steps

1. Carefully peel off the tweeter speaker from its compartment next to the fan connector to create more space to disconnect the fan cable.
2. Disconnect the right fan cable from the system board.
3. Remove the two (M2x4) screws that secure the right fan to the palm-rest and keyboard assembly.
4. Lift the fan from its outer edge and slide it away from the palm-rest and keyboard assembly.

Installing the right fan

Prerequisites

If you are replacing a component, remove the existing component before performing the installation procedure.

About this task

The following images indicate the location of the right fan and provide a visual representation of the installation procedure.



2x
M2x4

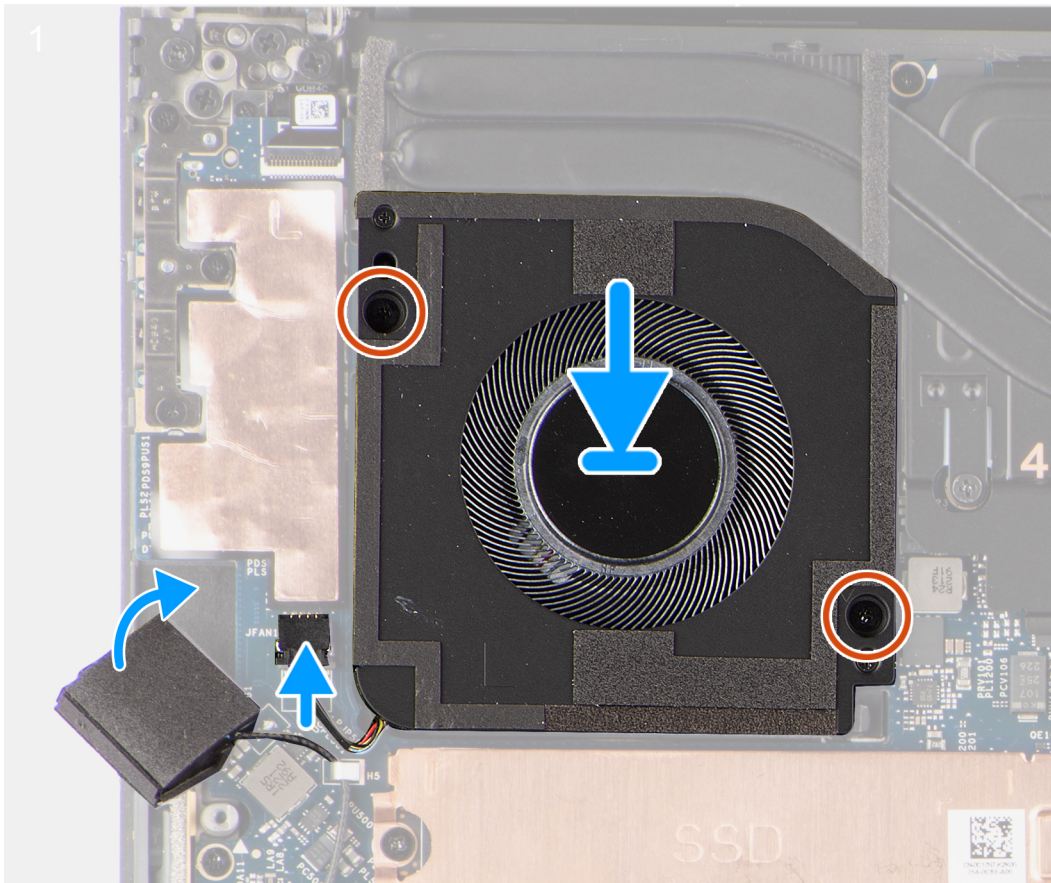
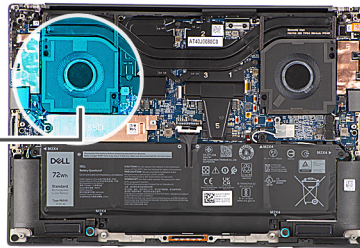
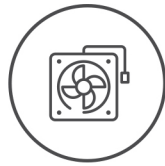

Steps

1. Align the screw holes on right fan with the screw holes on the palm-rest and keyboard assembly.
2. Replace the two (M2x4) screws that secure the right fan to the palm-rest and keyboard assembly.
3. Connect the right fan cable to the system board.
4. Adhere the tweeter speaker in its compartment on the palm-rest and keyboard assembly.

Next steps

1. Install the [base cover](#).
2. Follow the procedure in [After working inside your computer](#).

Heat sink

Removing the heat sink for integrated graphics

Prerequisites

1. Follow the procedure in [Before working inside your computer](#).
2. Remove the [base cover](#).

About this task

The figure indicates the location of the heat sink and provides a visual representation of the removal procedure.

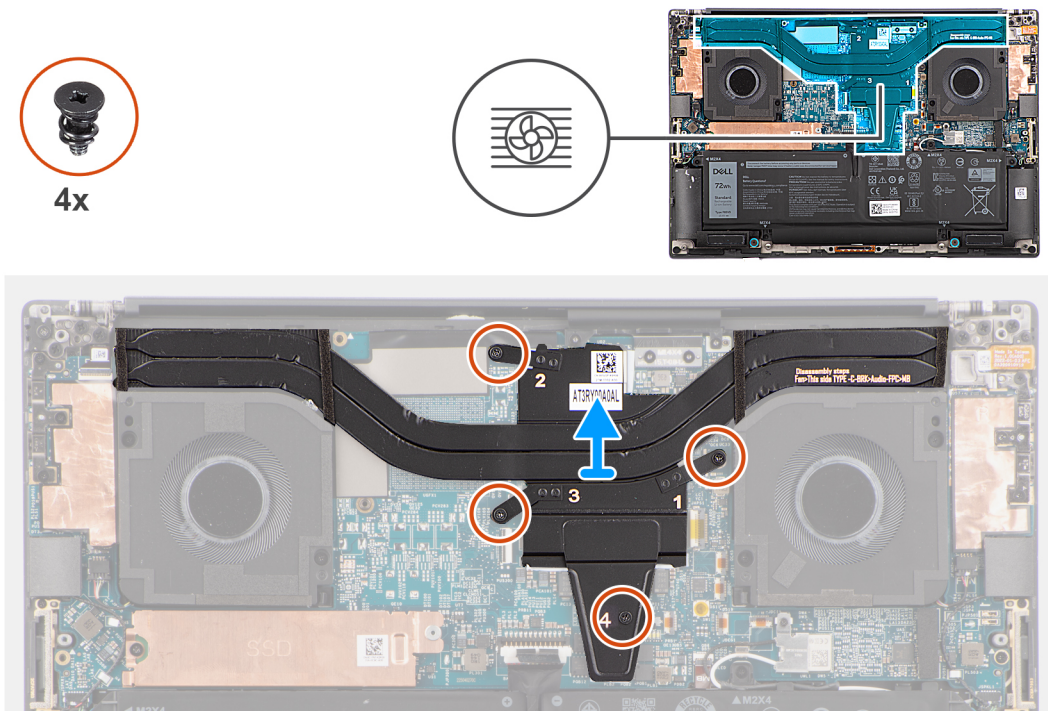

Steps

1. Loosen the four captive screws that secure the heat sink to the system board.
i **NOTE:** Loosen the captive screws in the order that is marked on the heat sink assembly next to the screws [4 > 3 > 2 > 1].
2. Carefully lift the heat sink to remove it from the system board.

Installing the heat sink for integrated graphics

Prerequisites

If you are replacing a component, remove the existing component before performing the installation procedure.

About this task

The figure indicates the location of the heat sink and provides a visual representation of the installation procedure.

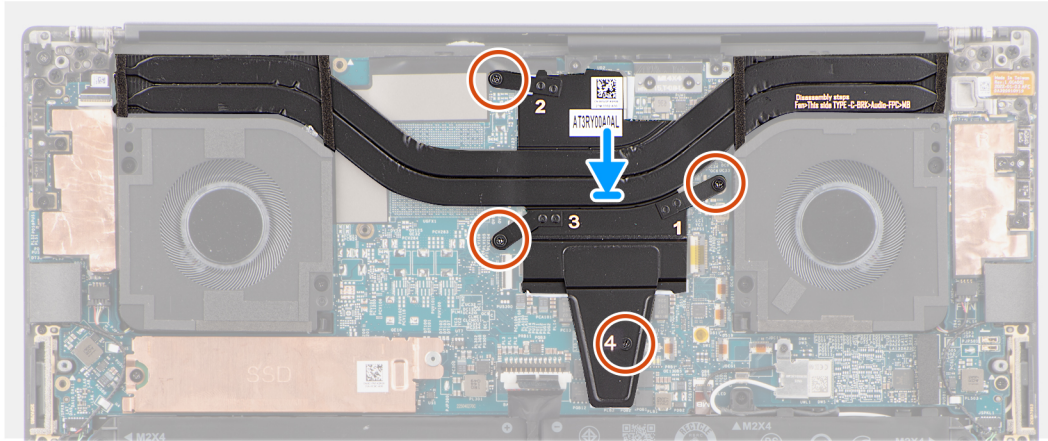
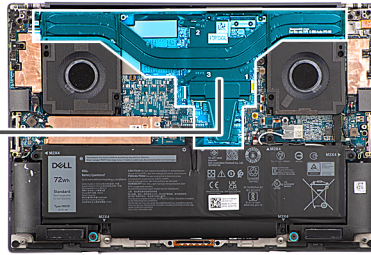

Steps

1. Align and insert the heat sink into its slot on the system board.
2. Tighten the four captive screws that secure the heat sink to the system board.

NOTE: Tighten the captive screws in the order that is marked on the heat sink next to the screws [1 > 2 > 3 > 4].

CAUTION: Do NOT over-torque the screws for the heat sink. Install the screws to a point where they are firmly secured. Over-torquing the screws can flex and damage the system board.

Next steps

1. Install the [base cover](#).
2. Follow the procedure in [After working inside your computer](#).

Removing the heat sink for discrete graphics

Prerequisites

1. Follow the procedure in [Before working inside your computer](#).
2. Remove the [base cover](#).

About this task

The figure indicates the location of the heat sink and provides a visual representation of the removal procedure.

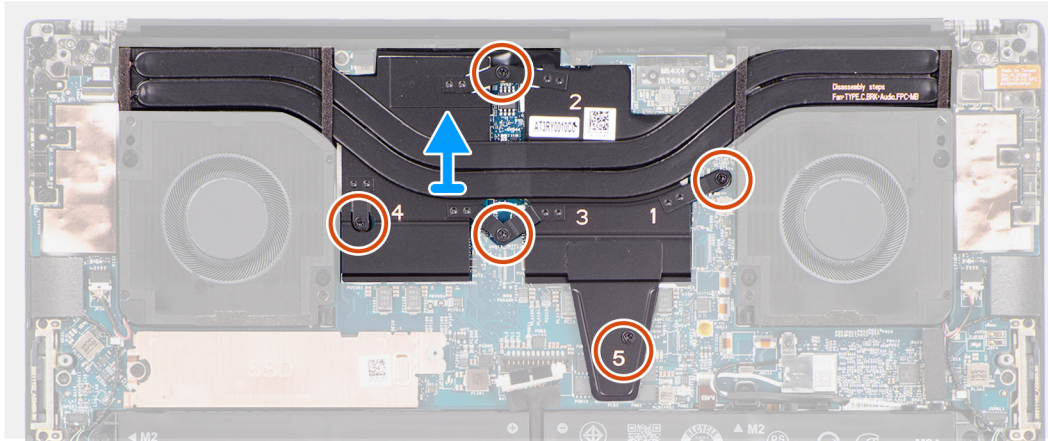
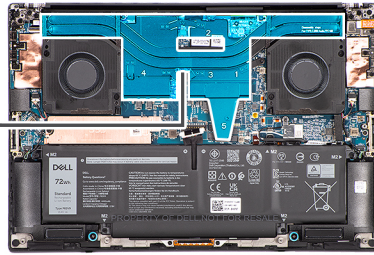

Steps

1. Loosen the five captive screws that secure the heat sink to the system board.

 **NOTE:** Loosen the captive screws in the order that is marked on the heat sink assembly next to the screws [5 > 4 > 3 > 2 > 1].

2. Carefully lift the heat sink to remove it from the system board.

Installing the heat sink for discrete graphics

Prerequisites

If you are replacing a component, remove the existing component before performing the installation procedure.

About this task

The figure indicates the location of the heat sink and provides a visual representation of the installation procedure.

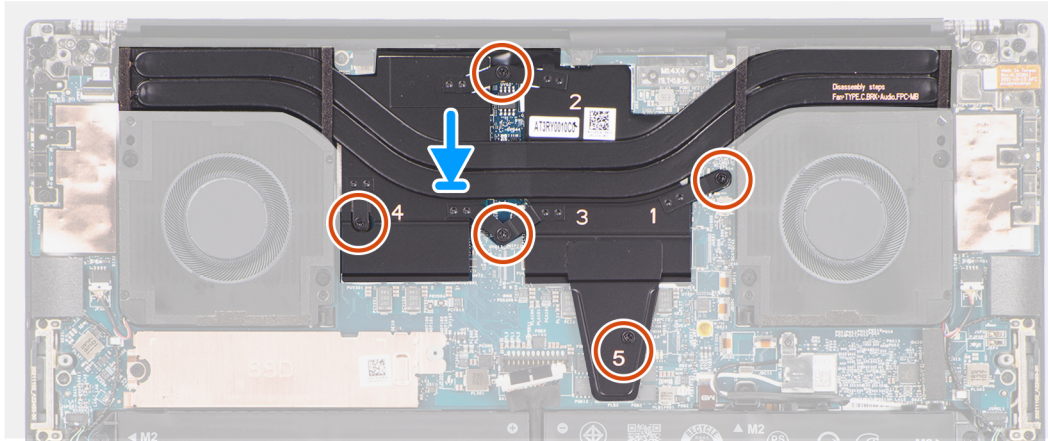
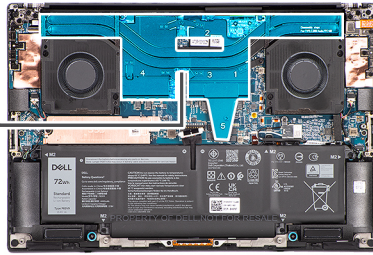

Steps

1. Align and insert the heat sink into its slot on the system board.
2. Tighten the five captive screws that secure the heat sink to the system board.

NOTE: Tighten the captive screws in the order that is marked on the heat sink next to the screws [1 > 2 > 3 > 4 > 5].

CAUTION: Do not over-torque the screws for the heat sink. Install the screws to a point where they are firmly secured. Over-torquing the screws can flex and damage the system board.

Next steps

1. Install the [base cover](#).
2. Follow the procedure in [After working inside your computer](#).

Audio jack

Removing the audio jack

Prerequisites

1. Follow the procedure in [Before working inside your computer](#).
2. Remove the [base cover](#).

About this task

The following images indicate the location of the audio jack and provide a visual representation of the removal procedure.



3x
M2x4



1x
M1.6x3

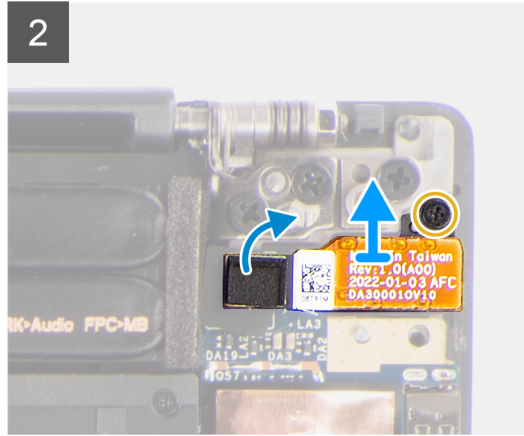
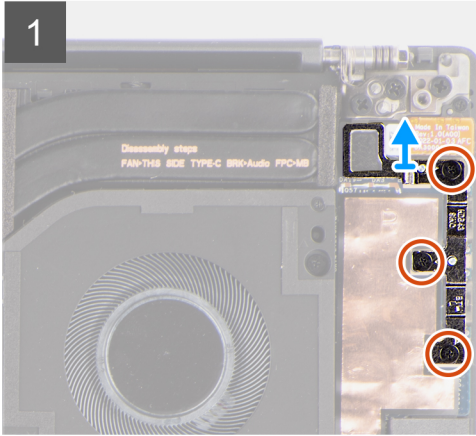
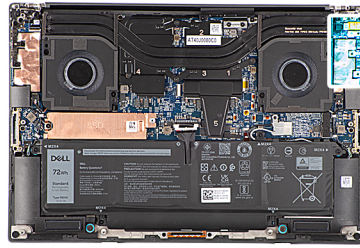

Steps

1. Remove the three (M2x4) screws that secure the left USB Type-C bracket to the system board.
2. Lift to remove the left USB Type-C bracket from the system board.
3. Disconnect the audio jack FPC from its connector on the system board.
4. Remove the (M1.6x3) screw that secures the audio jack to the system board.
5. Lift to remove the audio jack from the palm-rest and keyboard assembly.

Installing the audio jack

Prerequisites

If you are replacing a component, remove the existing component before performing the installation procedure.

About this task

The following images indicate the location of the audio jack and provide a visual representation of the installation procedure.



3x
M2x4



1x
M1.6x3

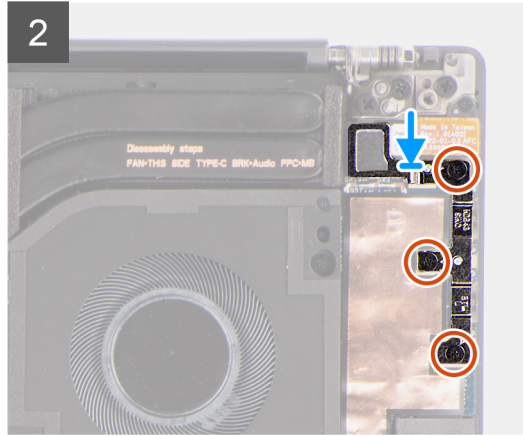
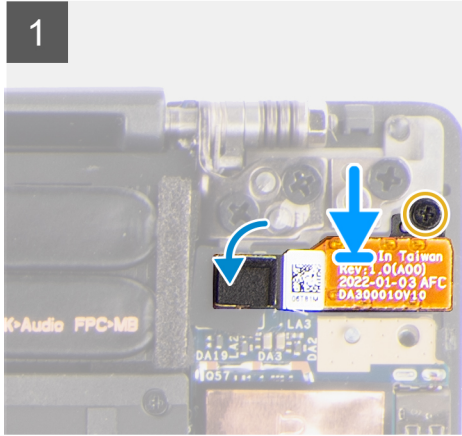
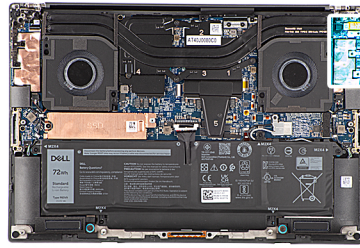

Steps

1. Align and place the audio jack in its slot on the palm-rest and keyboard assembly.
2. Connect the audio jack FPC to its connector on the system board.
3. Replace the (M1.6x3) screw to secure the audio jack to the system board.
4. Align and place the left USB Type-C bracket on the system board.
5. Replace the three (M2x4) screws that secure the left USB Type-C bracket to the system board.

Next steps

1. Install the [base cover](#).
2. Follow the procedure in [After working inside your computer](#).

Speakers

Removing the speaker

Prerequisites

1. Follow the procedure in [Before working inside your computer](#).
2. Remove the [base cover](#).
3. Remove the [battery](#).

About this task

The figure indicates the location of the speaker and provides a visual representation of the removal procedure.



2x
M1.6x1.8

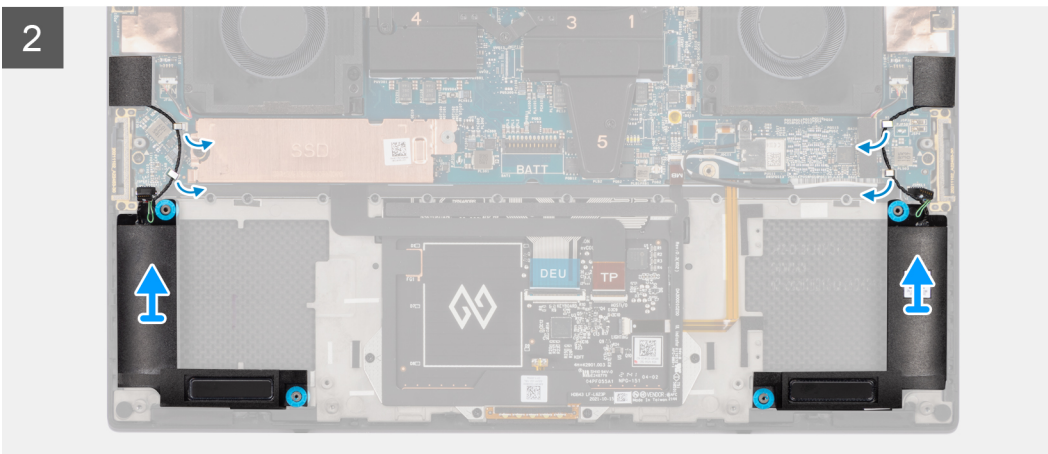
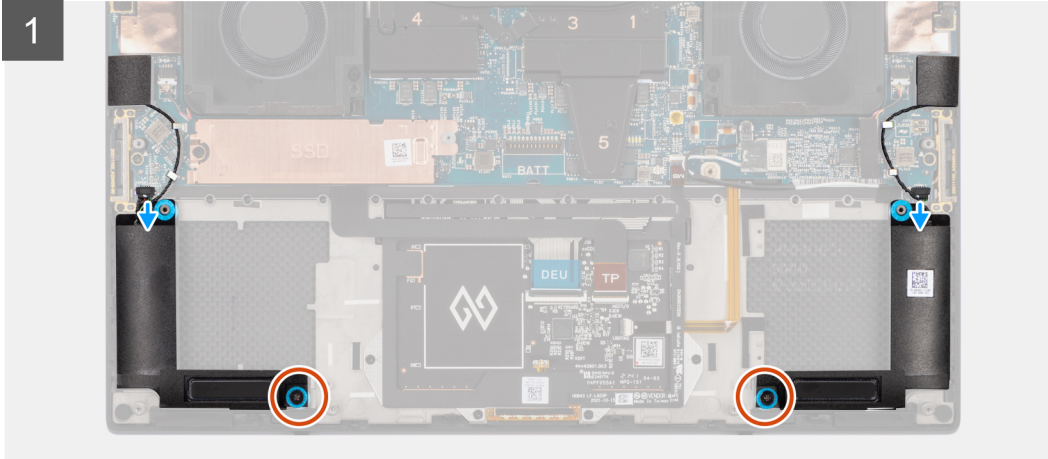
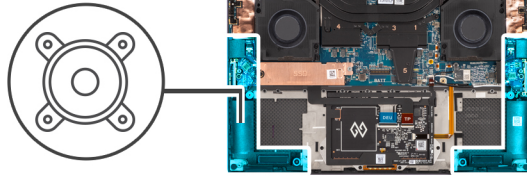

Steps

1. Disconnect the left and right speaker cables from the connectors on the system board.
2. Peel the left and right tweeter speakers from their compartments on the palm-rest and keyboard assembly.
3. Remove the two (M1.6x1.8) screws that secure the left and right speakers to the palm-rest and keyboard assembly.
4. Unroute the left and right tweeter speaker cables from their routing guides on the system board.
5. Lift to remove the left and right speakers from the palm-rest and keyboard assembly.

Installing the speaker

Prerequisites

If you are replacing a component, remove the existing component before performing the installation procedure.

About this task

The figure indicates the location of the speakers and provides a visual representation of the installation procedure.



2x
M1.6x1.8

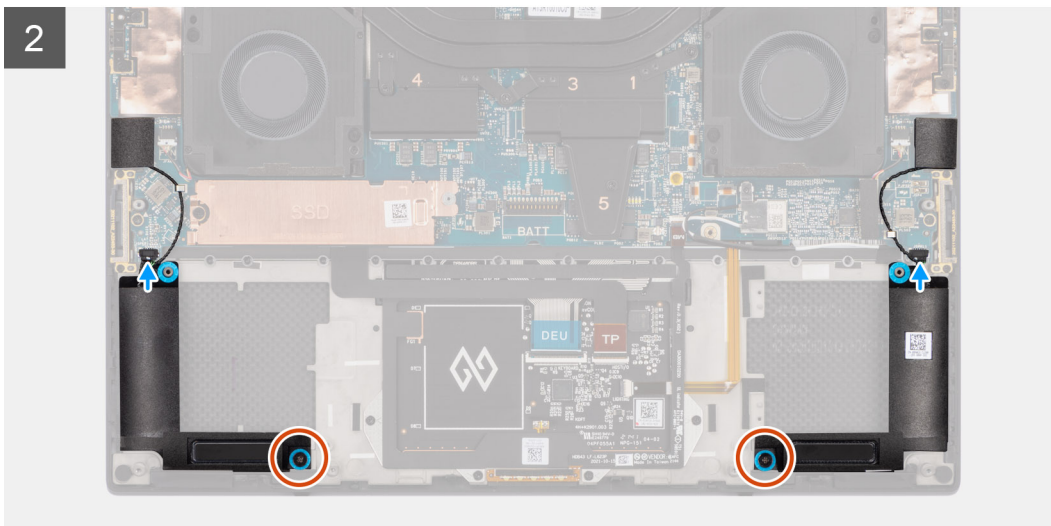
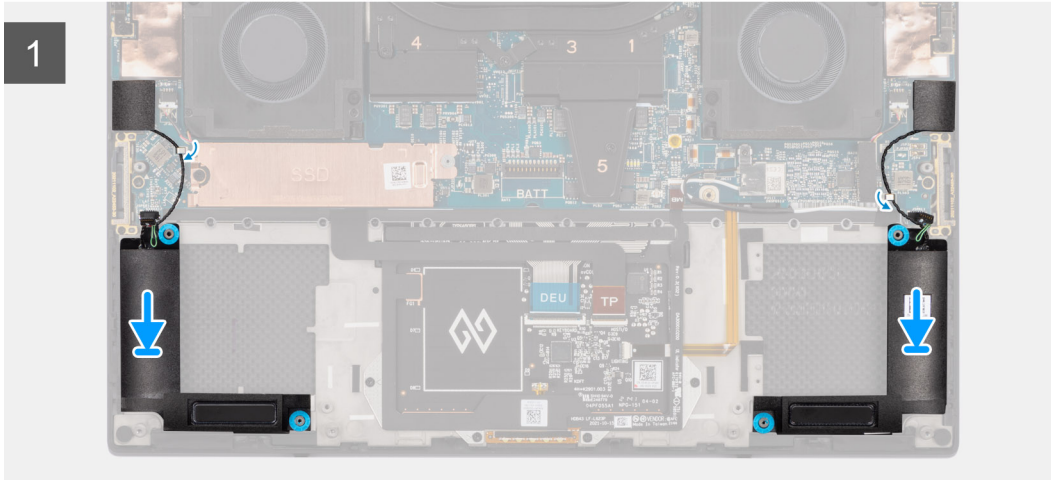
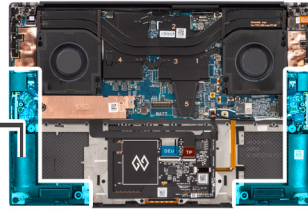
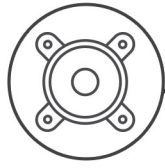

Steps

1. Align and place the left and right speakers into its slot on the palm-rest and keyboard assembly.
2. Route the left and right tweeter speakers using the routing guides on the system board.
3. Replace the two (M1.6x1.8) screws that secure the left and right speakers to the palm-rest and keyboard assembly.
4. Adhere the left and right tweeter speakers in their compartments on the system board.
5. Connect the left and right speaker cables to the connectors on the system board.

Next steps

1. Install the [battery](#).
2. Install the [base cover](#).
3. Follow the procedure in [After working inside your computer](#).

Smart-card reader

Removing the smart-card reader

Prerequisites

1. Follow the procedure in [before working inside your computer](#).
2. Remove the [base cover](#).
3. Remove the [battery](#).
4. Remove the [speakers](#).

About this task

The figure indicates the location of the smart-card reader and provides a visual representation of the removal procedure.

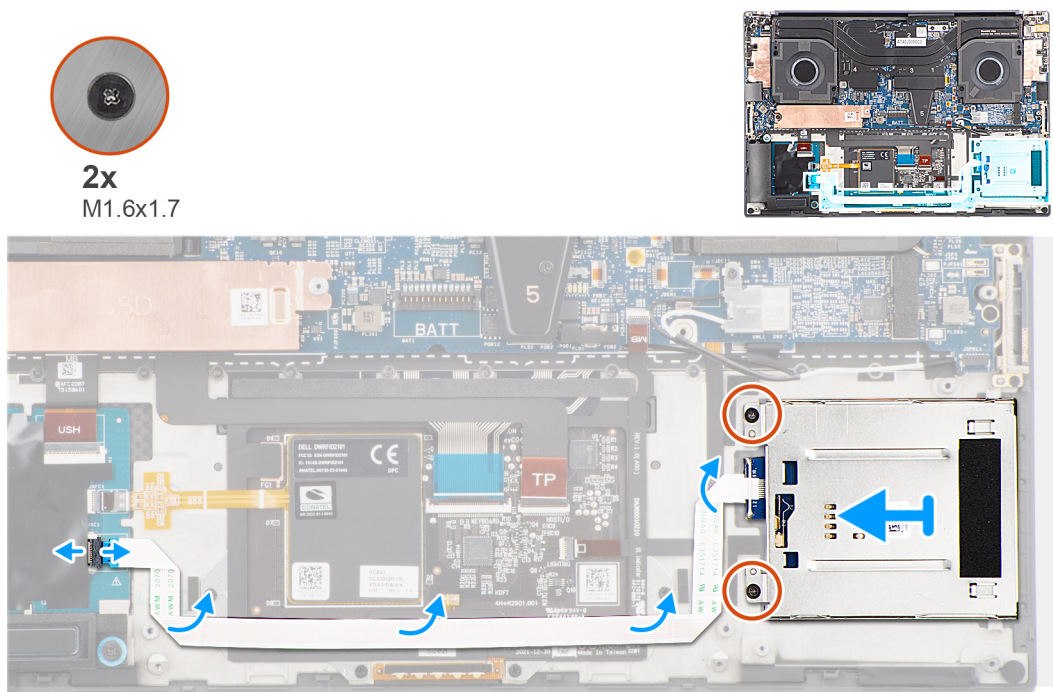

Steps

1. Disconnect the smart-card reader FFC from the connector on the USH board.
2. Peel the smart-card reader FFC from the palm-rest and keyboard assembly.
3. Remove the two (M1.6x1.7) screws that secure the smart-card reader to the palm-rest and keyboard assembly.
4. Lift the smart-card reader module away from the palm-rest and keyboard assembly.

Installing the smart-card reader

Prerequisites

If you are replacing a component, remove the existing component before performing the installation procedure.

About this task

The figure indicates the location of the smart-card reader and provides a visual representation of the installation procedure.



2x
M1.6x1.7

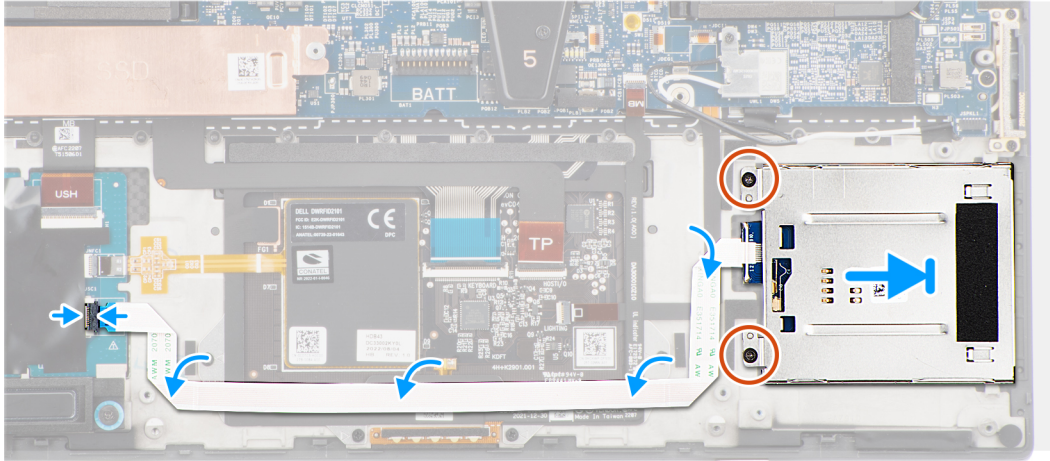
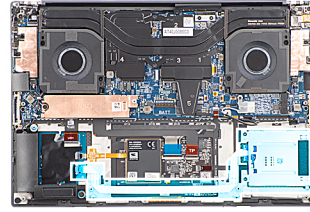

Steps

1. Align and place the smart-card reader into its slot on the palm-rest and keyboard assembly.
2. Replace the two (M1.6x1.7) screws to secure the smart-card reader to the palm-rest and keyboard assembly.
3. Adhere the smart-card reader FFC to the palmrest and keyboard assembly.
4. Connect the smart-card reader FFC to the connector on the USH board.

Next steps

1. Install the [speakers](#).
2. Install the [battery](#).
3. Install the [base cover](#).
4. Follow the procedure in [after working inside your computer](#).

Display assembly

Removing the display assembly

Prerequisites

1. Follow the procedure in [Before working inside your computer](#).
2. Remove the [base cover](#).

About this task

The figure indicates the location of the display assembly and provides a visual representation of the removal procedure.



6x
M2.5x5



4x
M1.4x4, T5

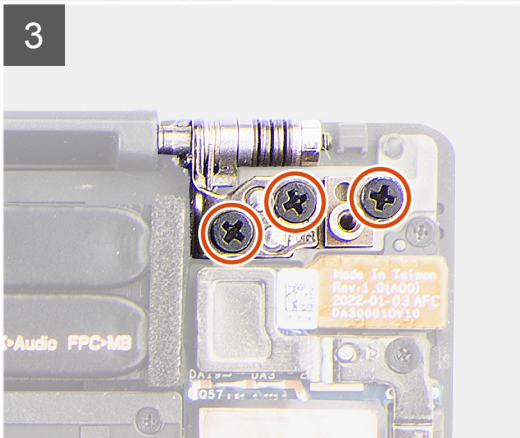
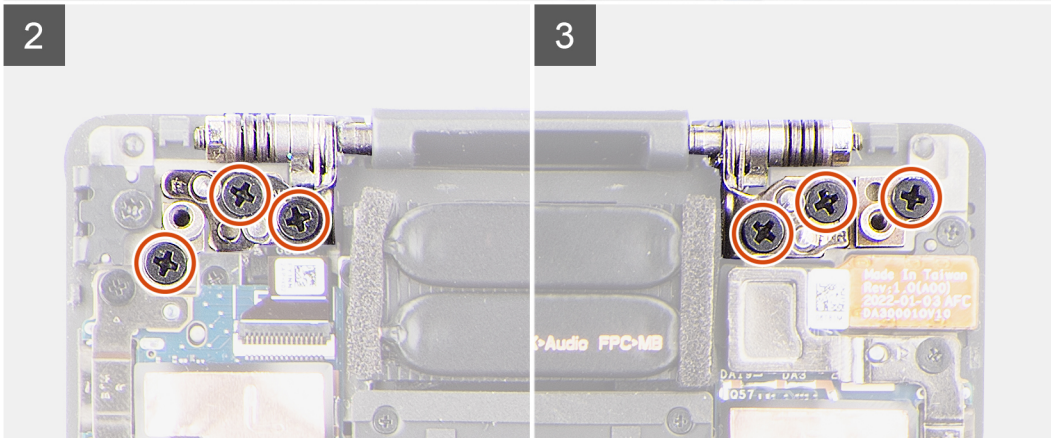
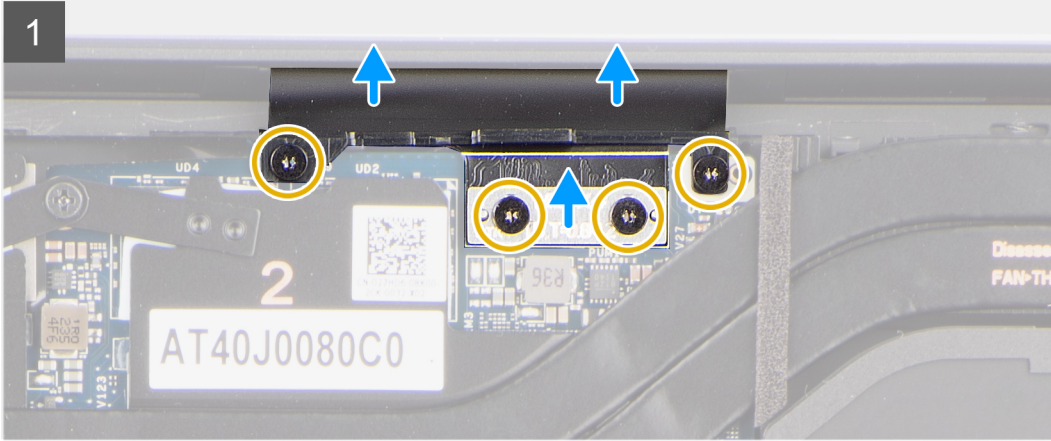
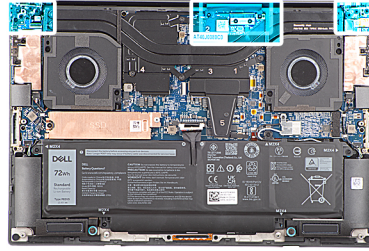

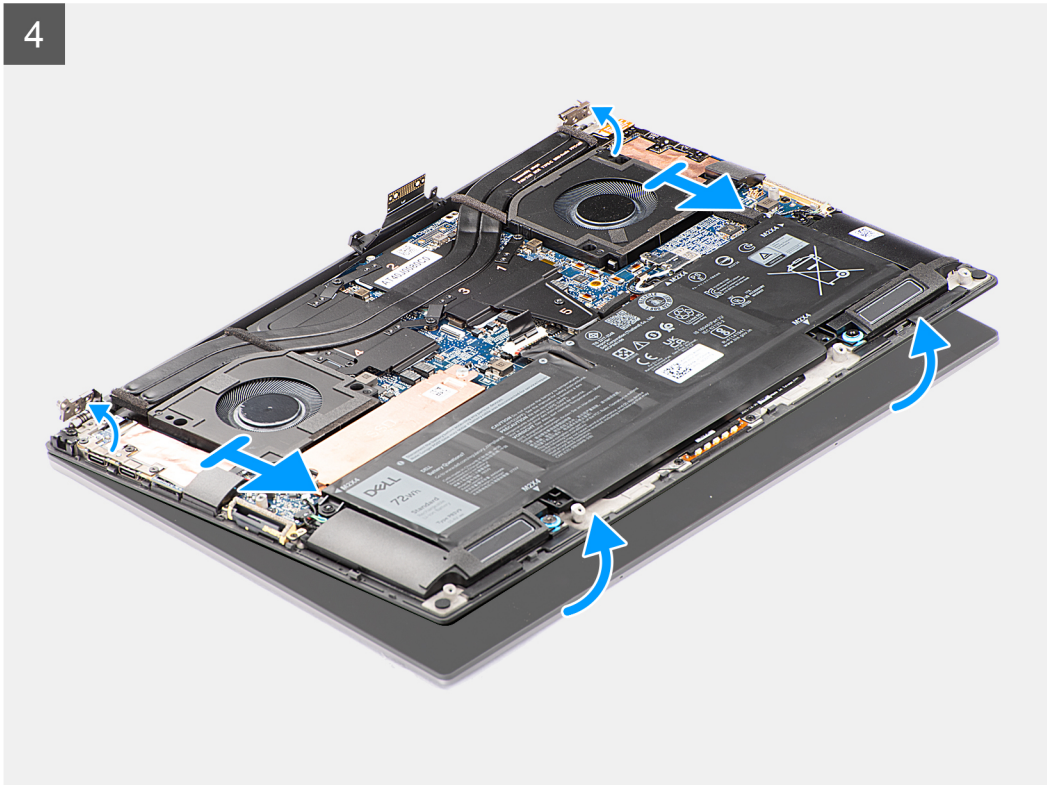

Steps

1. Remove the two (T5, M1.4x4) Torx screws that secure the display FPC holder to the system board.
2. Remove the two (T5, M1.4x4) Torx screws that secure the display FPC to the system board.
3. Disconnect the display FPC from the system board and remove the interposer board.

CAUTION: The pins on the interposer board are very fragile. Do not push or apply pressure to the pins on the interposer board or perform any action that may scratch the pins, such as rotating/turning the board while they are in contact with any surface. When handling the interposer board, lift and hold the board from the edges or the sides.

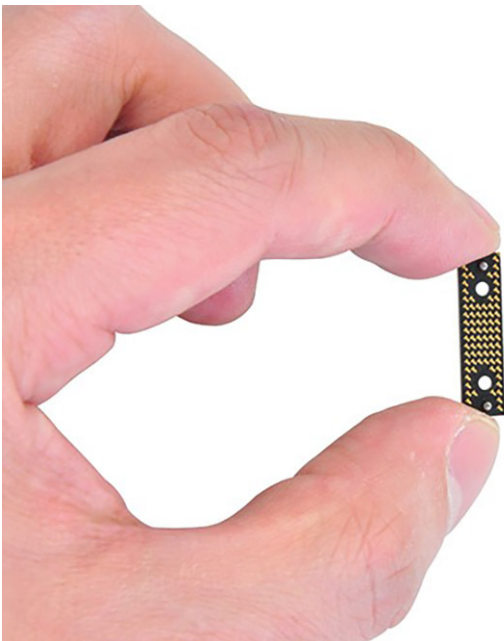

4. Remove the six (M2.5x5) screws that secure the display hinges to the palm-rest and keyboard assembly.

5. Slide the bottom assembly slightly to the left and then move it away from the display assembly.

NOTE: The display assembly is a Hinge-Up Design (HUD) assembly and cannot be further disassembled once it is removed from the bottom chassis. If any components in the display assembly are malfunctioning, then you must replace the entire display assembly.

Installing the display assembly

Prerequisites

If you are replacing a component, remove the existing component before performing the installation procedure.

About this task

The figure indicates the location of the display assembly and provides a visual representation of the installation procedure.

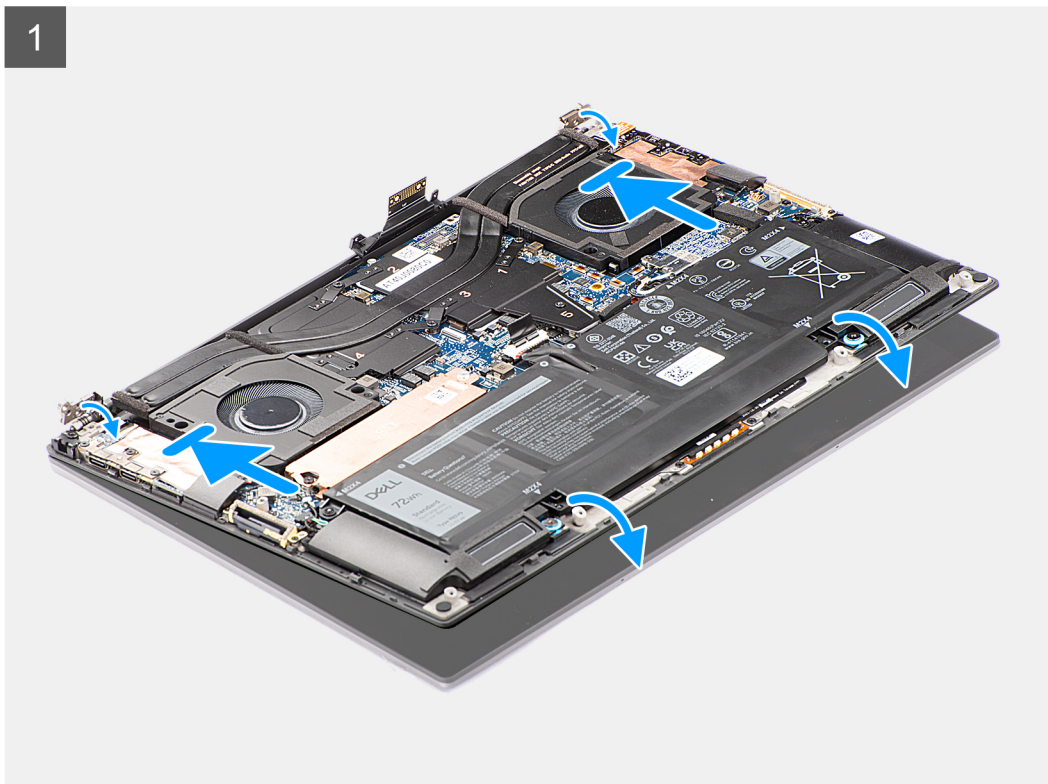

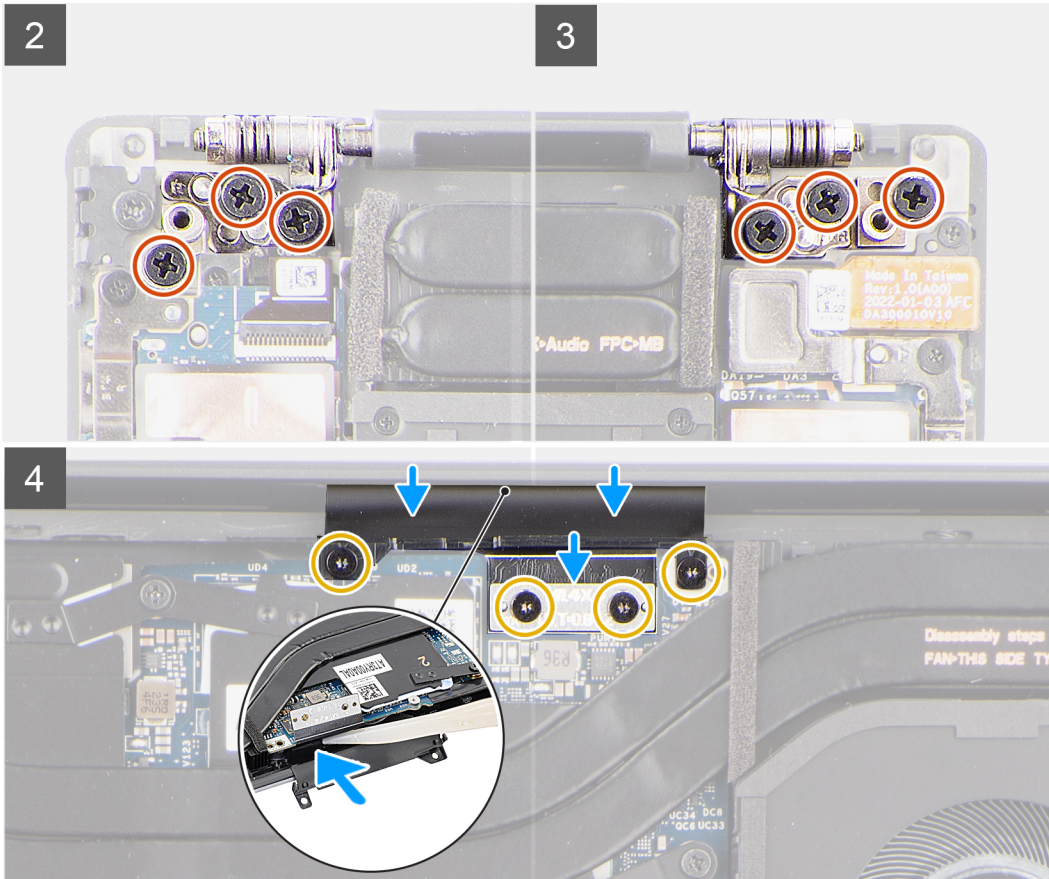
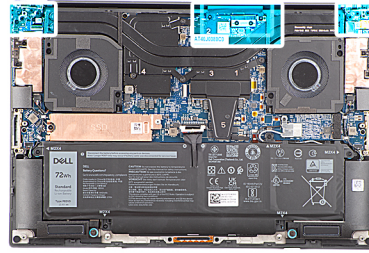
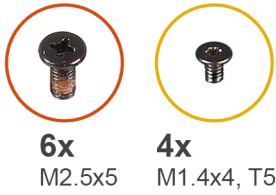

Steps

1. Align the screw holes on the display hinges to the screw holes on the palm-rest and keyboard assembly.
2. Replace the six (M2.5x5) screws to secure the display assembly to the palm-rest and keyboard assembly.
3. Use a plastic scribe to tuck the display FPC into the gap between the system board and the bottom assembly until the white line on the display connector lines up with the edge of the system board.
4. Place the interposer board and connect the display FPC to the system board.
5. Replace the two (T5, M1.4x4) Torx screws that secure the display FPC to the system board.
6. Replace the two (T5, M1.4x4) Torx screws that secure the display FPC holder to the system board.

Next steps

1. Install the [base cover](#).
2. Follow the procedure in [After working inside your computer](#).

System board

Removing the system board

Prerequisites

1. Follow the procedure in [before working inside your computer](#).
2. Remove the [base cover](#).
3. Remove the [M.2 2230 solid state drive](#) or [M.2 2280 solid state drive](#).
4. Remove the [battery](#).
5. Remove the [left fan](#).
6. Remove the [right fan](#).
7. Remove the [audio jack](#).
8. Remove the [heat sink for integrated graphics](#) or [heat sink for discrete graphics](#).

About this task

The following image indicates the connectors on your system board:

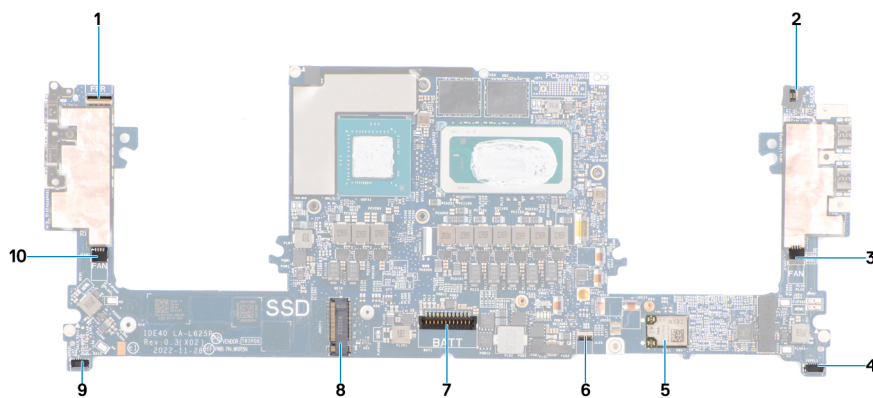

1. Power button with fingerprint reader FPC connector
2. Audio jack FPC connector
3. Left fan cable connector
4. Left tweeter speaker cable connector
5. Integrated WLAN card
6. Battery LED FPC connector
7. Battery cable connector
8. M.2 2230/2280 solid state drive slot
9. Right tweeter speaker cable connector
10. Right fan cable connector

The figure indicates the location of the system board and provides a visual representation of the removal procedure.



6x
M2x4



4x
M1.4x4



1x
M1.6x2.3



4x
M1.4x1.2

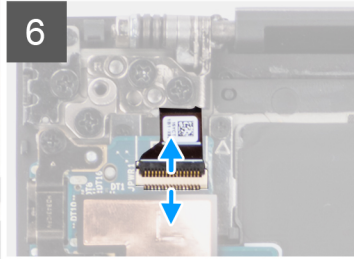
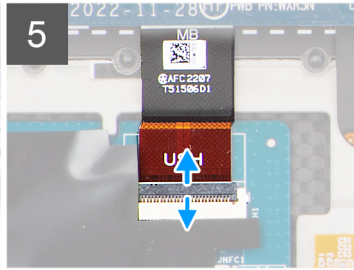
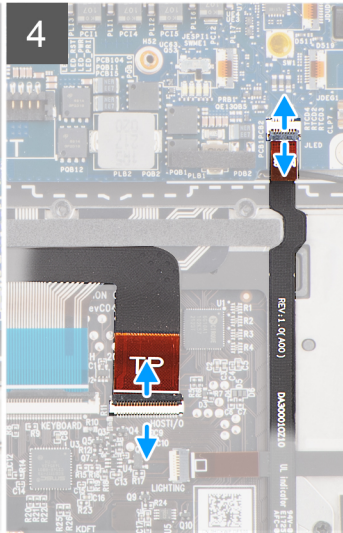
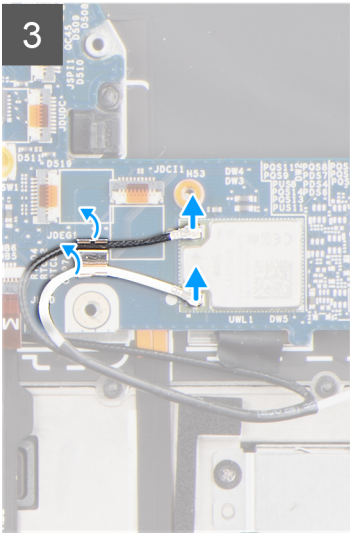
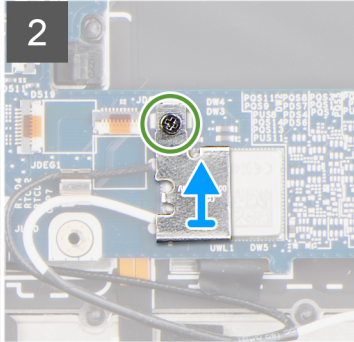
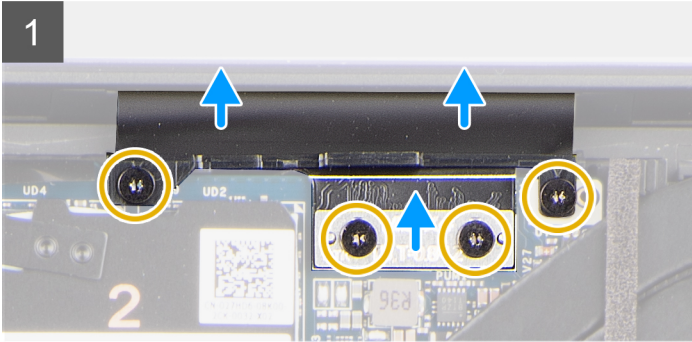
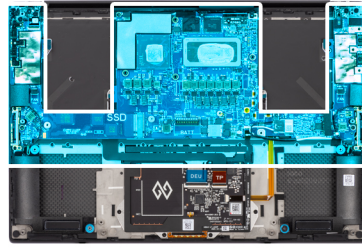

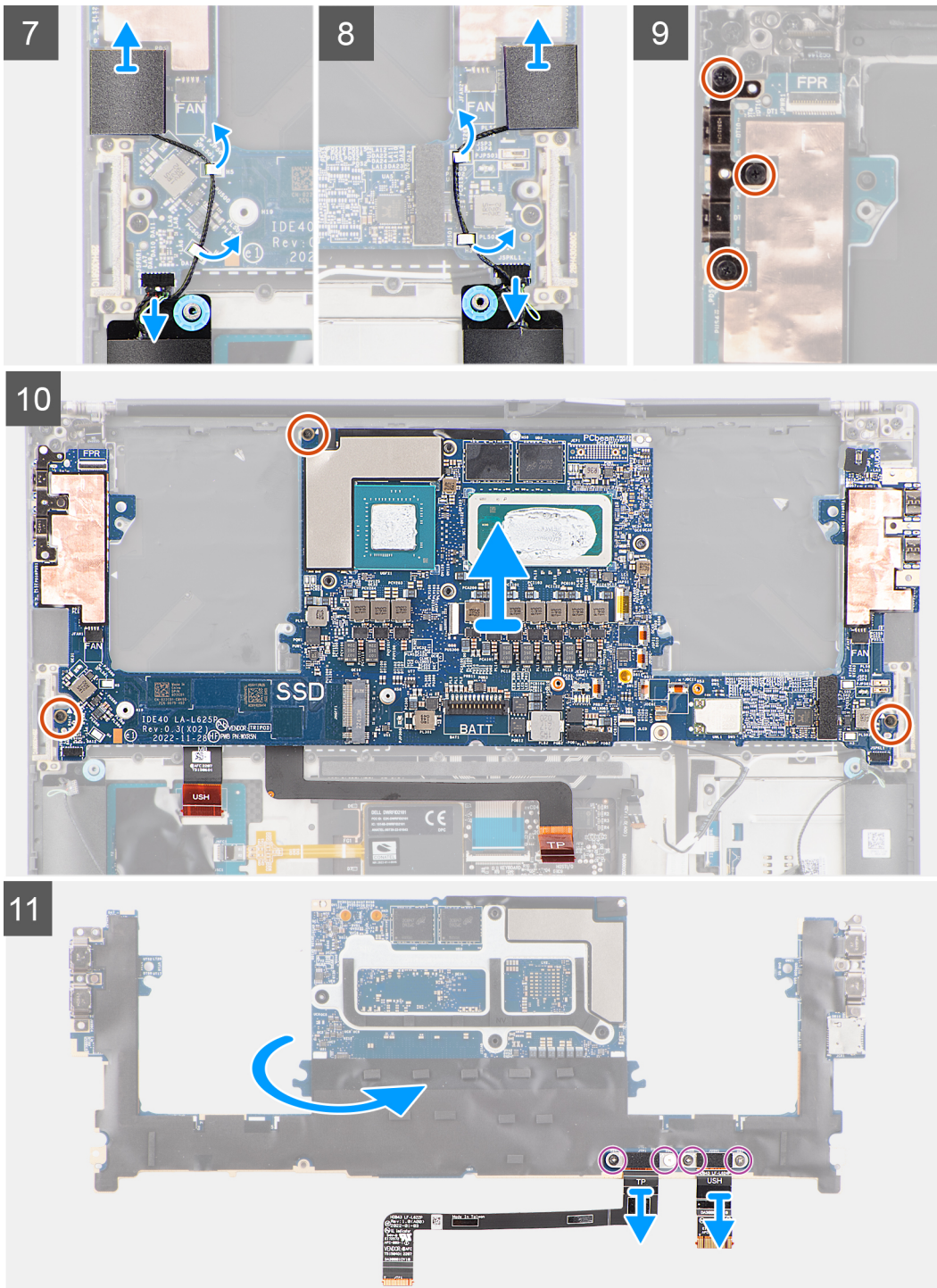

Steps

1. Remove the four (T5, M1.4x4) Torx screws that secure the display FPC holder and display FPC to the system board.
2. Disconnect the display FPC from the system board and remove the interposer board.

CAUTION: Technicians must remove the interposer board immediately after disconnecting the display FPC to prevent the board from falling out of the system during subsequent removal procedures. The pins on the interposer board are fragile. Avoid contact with the pins on the board. Instead, handle the board by lifting and holding from the edges or the sides.

3. Loosen the single (M1.6x2.3) captive screw that secure the WLAN bracket to the system board.
4. Disconnect the antenna cables from the WLAN module and unroute them from the metal clips on the system board.
5. Open the latch and disconnect the battery LED FPC from the system board.

6. Open the latch and disconnect the USH board FPC (for models shipped with a USH board) and touchpad FPC from their respective connectors.
7. Open the latch and disconnect the power button board with fingerprint reader FPC from the system board.
8. Peel the left and right tweeter speakers from their compartments on the palm-rest and keyboard assembly.
9. Unroute the tweeter speaker cables from the metal clips on the system board.
10. Disconnect the left and right speaker cables from the system board.
11. Remove the three (M2x4) screws that secure the right USB Type-C bracket to the system board.
12. Remove the three (M2x4) screws that secure the system board to the palm-rest and keyboard assembly.
13. Remove the system board from the palm-rest and keyboard assembly.
14. Flip-over the system board and remove the four (M1.4x1.2) screws that secure the USH board FPC (for models shipped with a USH board) and touchpad FPC to the system board.
15. Remove the USH board FPC (for models shipped with a USH board) and touchpad FPC away from the system board.

NOTE: The USH board FPC and touchpad FPC must be transferred to the new replacement system board.

Installing the system board

Prerequisites

If you are replacing a component, remove the existing component before performing the installation procedure.

About this task

The following image indicates the connectors on your system board:

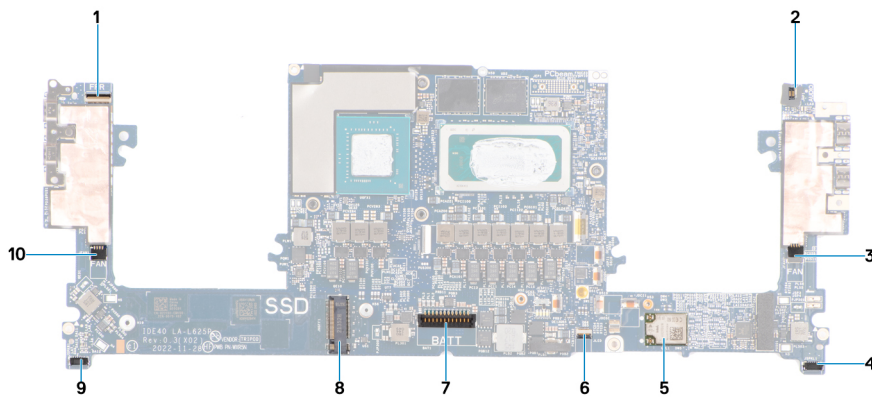

1. Power button with fingerprint reader FPC connector
2. Audio jack FPC connector
3. Left fan cable connector
4. Left tweeter speaker cable connector
5. Integrated WLAN card
6. Battery LED FPC connector
7. Battery cable connector
8. M.2 2230/2280 solid state drive slot
9. Right tweeter speaker cable connector
10. Right fan cable connector

The figure indicates the location of the system board and provides a visual representation of the installation procedure

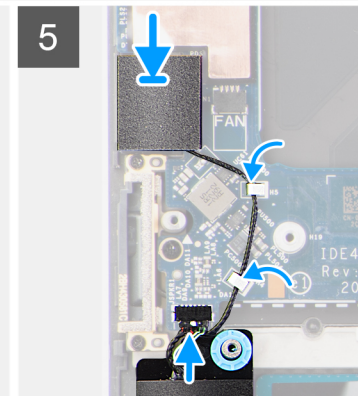
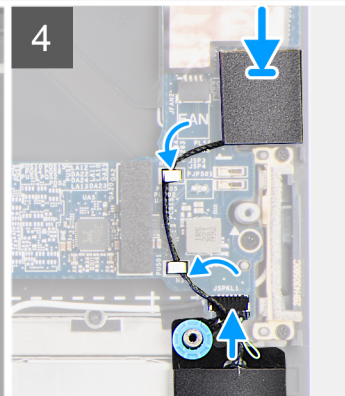
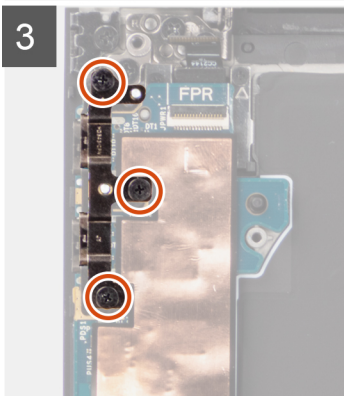
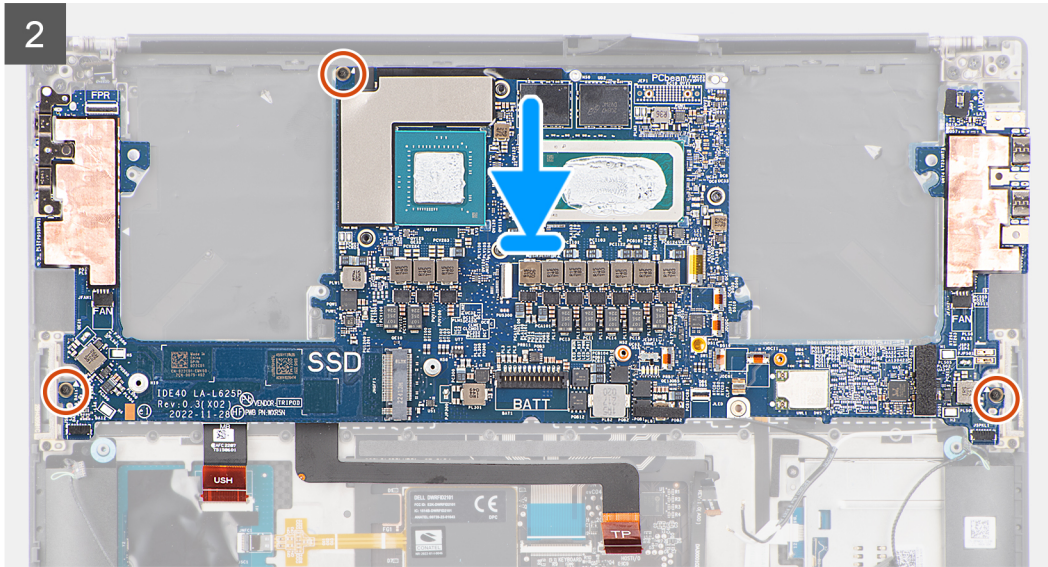
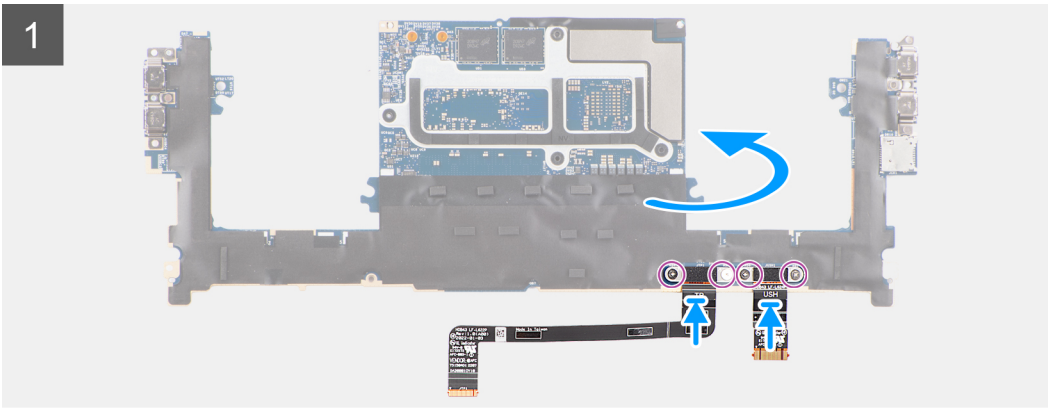

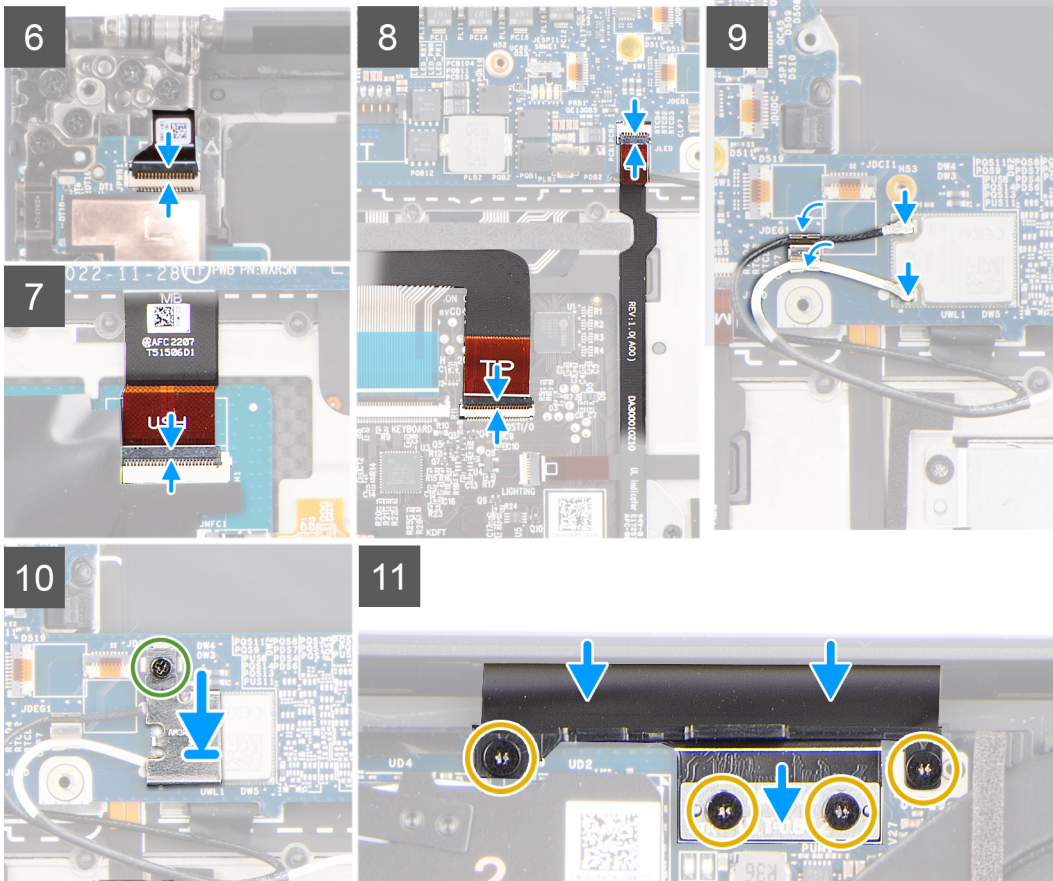
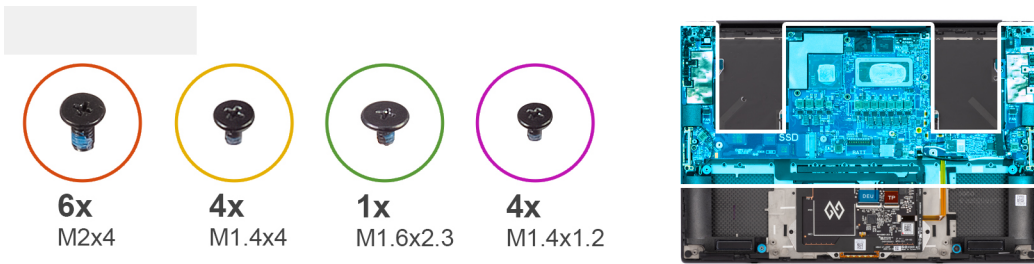

Steps

1. Align the screw holes on the USH board FPC (for models shipped with a USH board) and touchpad FPC.
2. Replace the four (M1.4x1.2) screws to secure the USH board FPC (for models shipped with a USH board) and touchpad FPC to the system board.
3. Flip-over the system board and align the screw holes on the system board with the holes on the palm-rest and keyboard assembly.
4. Replace the three (M2x4) screws to secure the system board to the palm-rest and keyboard assembly.
5. Replace the three (M2x4) screws to secure the right USB Type-C bracket on the system board.
6. Adhere the left and right tweeter speakers to their compartments on the palm-rest and keyboard assembly and route the speaker cables through the metal clips on the system board.
7. Connect the left and right speaker cables to the connectors on the system board.
8. Connect the power button board with fingerprint reader FPC to the connector on the system board and close the latch.
9. Connect the USH board FPC (for models shipped with a USH board) and touchpad FPC to their respective connectors and close the latch.
10. Connect the battery LED FPC to the system board and close the latch.
11. Route the WLAN antenna cables using the metal clips on the system board and connect them to the WLAN module.
12. Tighten the single (M1.6x2.3) captive screw to secure the WLAN bracket on the system board.
13. Place the interposer board and connect the display FPC to the system board.
14. Replace the four (T5, M1.4x4) Torx screws that secure the display FPC holder and display FPC to the system board.

Next steps

1. Install the [heat sink for integrated graphics](#) or [heat sink for discrete graphics](#).
2. Install the [audio jack](#).
3. Install the [right fan](#).
4. Install the [left fan](#).
5. Install the [battery](#).
6. Install the [M.2 2230 solid state drive](#) or [M.2 2280 solid state drive](#).
7. Install the [base cover](#).
8. Follow the procedure in [after working inside your computer](#).

Power button with fingerprint reader

Removing the power-button board with fingerprint reader

Prerequisites

1. Follow the procedure in [before working inside your computer](#).
2. Remove the [base cover](#).
3. Remove the [M.2 2230 solid state drive](#) or [M.2 2280 solid state drive](#).
4. Remove the [battery](#).
5. Remove the [left fan](#).
6. Remove the [right fan](#).
7. Remove the [audio jack](#).
8. Remove the [display assembly](#).
9. Remove the [system board](#).

 **NOTE:** The system board can be removed or installed together with the heat sink attached. This simplifies the procedure and avoids breaking the thermal bond between the system board and the heat sink.

About this task

The figure indicates the location of the power-button board with fingerprint reader and provides a visual representation of the removal procedure.



3x
M1.6x2

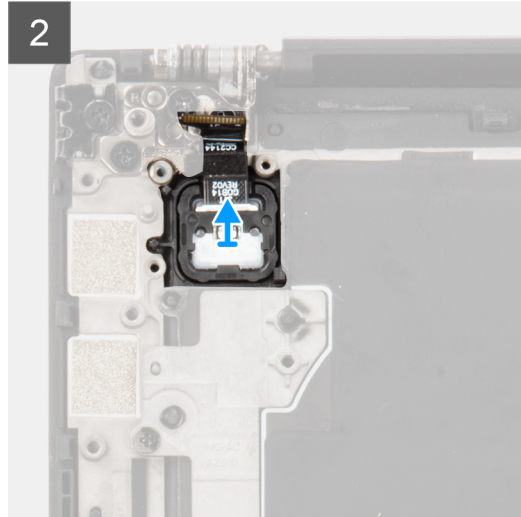
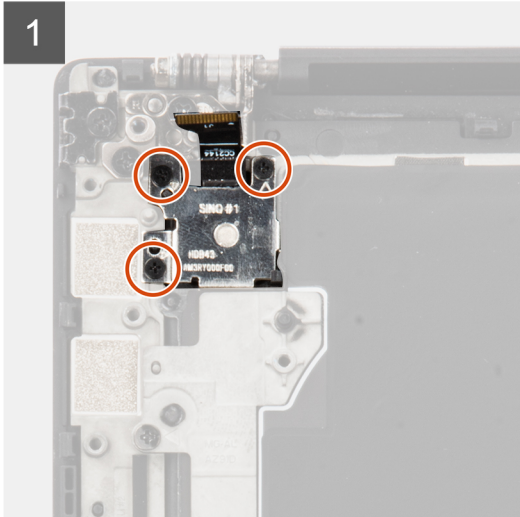
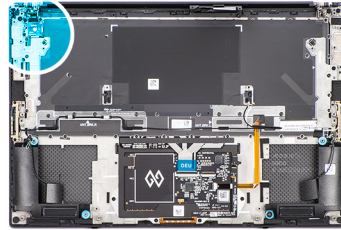

Steps

1. Remove the three (M1.6x2) screws that secure the fingerprint-reader bracket to the power-button board.
2. Remove the fingerprint-reader bracket from the power-button board.
3. Remove the power-button board with power-button FPC from the palm-rest and keyboard assembly.

Installing the power-button board with fingerprint reader

Prerequisites

If you are replacing a component, remove the existing component before performing the installation procedure.

About this task

The figure indicates the location of the power-button board with fingerprint reader and provides a visual representation of the installation procedure.



3x
M1.6x2

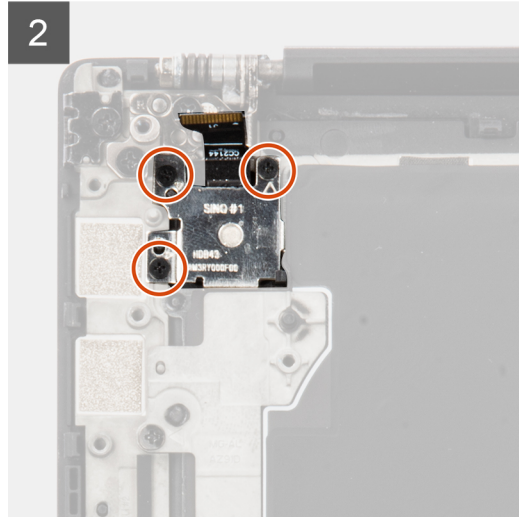
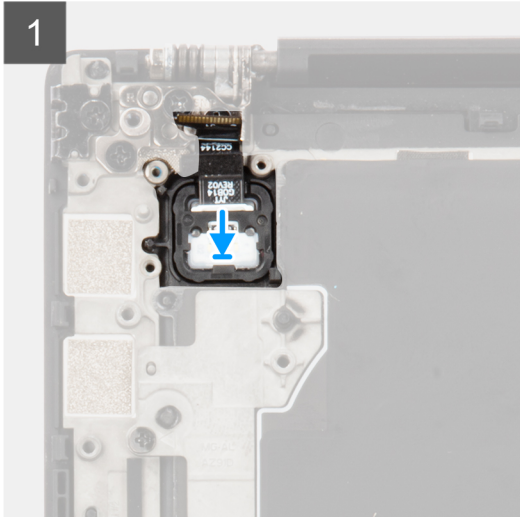
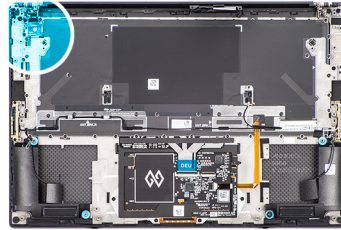

Steps

1. Align and place the power-button board with power-button FPC into its slot on the palm-rest and keyboard assembly.
2. Align and place the fingerprint-reader bracket on the power-button board.
3. Replace the three (M1.6x2) screws to secure the fingerprint-reader bracket to the power-button board.

Next steps

1. Install the [system board](#).
2. Install the [display assembly](#).
3. Install the [audio jack](#).
4. Install the [right fan](#).
5. Install the [left fan](#).
6. Install the [battery](#).
7. Install the [M.2 2230 solid state drive](#) or [M.2 2280 solid state drive](#).
8. Install the [base cover](#).
9. Follow the procedure in [after working inside your computer](#).

USH board

Removing the USH daughter-board

Prerequisites

1. Follow the procedure in [before working inside your computer](#).
2. Remove the [base cover](#).
3. Remove the [M.2 2230 solid state drive](#) or [M.2 2280 solid state drive](#).
4. Remove the [battery](#).
5. Remove the [left fan](#).
6. Remove the [right fan](#).
7. Remove the [audio jack](#).

8. Remove the [system board](#).

NOTE: The system board can be removed or installed together with the heat-sink attached. This simplifies the procedure and avoids breaking the thermal bond between the system board and the heat-sink.

About this task

The figure indicates the location of the USH daughter-board and provides a visual representation of the removal procedure.

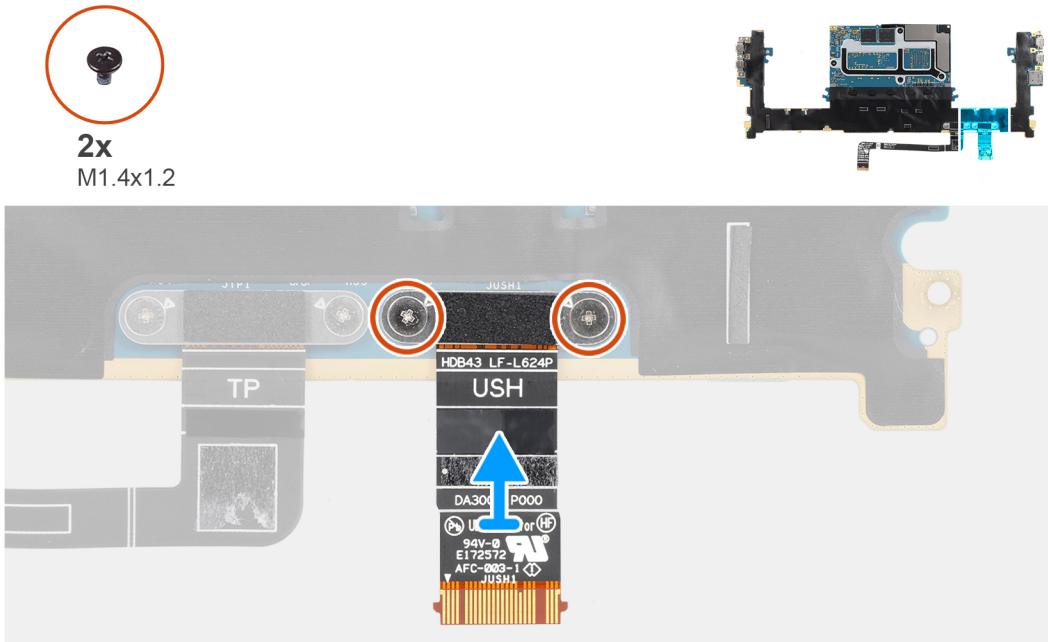

Steps

1. Remove the two (M1.4x1.2) screws that secure the USH board flat printed cable on the system board.
2. Remove the USH board flat printed cable from the system board.

Installing the USH daughter-board

Prerequisites

If you are replacing a component, remove the existing component before performing the installation procedure.

About this task

The figure indicates the location of the USH daughter-board and provides a visual representation of the installation procedure.



2x
M1.4x1.2

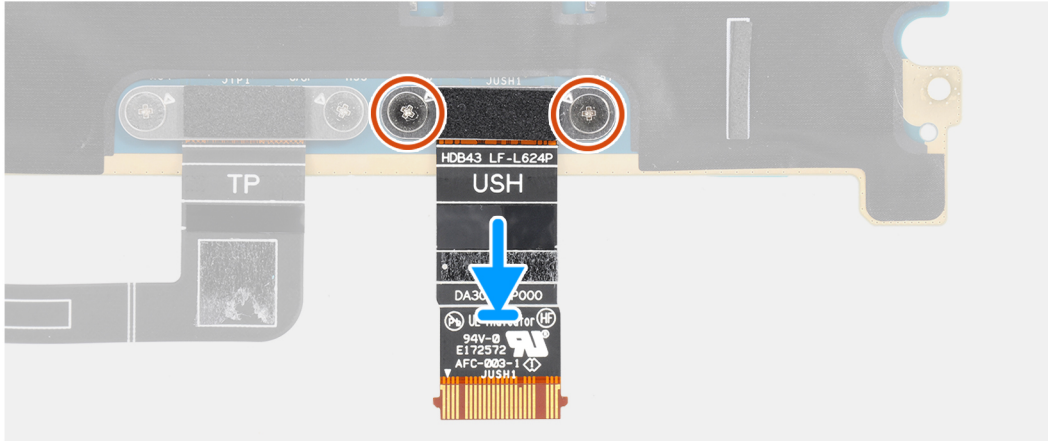

Steps

1. Align and place the USB board flat printed cable on the system board.
2. Replace the two (M1.4x1.2) screws that secure the USB board flat printed cable to the system board.

Next steps

1. Install the [system board](#).
2. Install the [audio jack](#).
3. Install the [right fan](#).
4. Install the [left fan](#).
5. Install the [battery](#).
6. Install the [M.2 2230 solid state drive](#) or [M.2 2280 solid state drive](#).
7. Install the [base cover](#).
8. Follow the procedure in [after working inside your computer](#).

WLAN antennas

Removing the WLAN antennas

Prerequisites

1. Follow the procedure in [before working inside your computer](#).
2. Remove the [base cover](#).
3. Remove the [M.2 2230 solid state drive](#) or [M.2 2280 solid state drive](#).
4. Remove the [battery](#).
5. Remove the [left fan](#).
6. Remove the [right fan](#).
7. Remove the [audio jack](#).
8. Remove the [system board](#).

NOTE: The system board can be removed or installed together with the heat-sink attached. This simplifies the procedure and avoids breaking the thermal bond between the system board and the heat-sink.

About this task

The figure indicates the location of the WLAN antennas and provides a visual representation of the removal procedure.



4x
M1.4x2.5

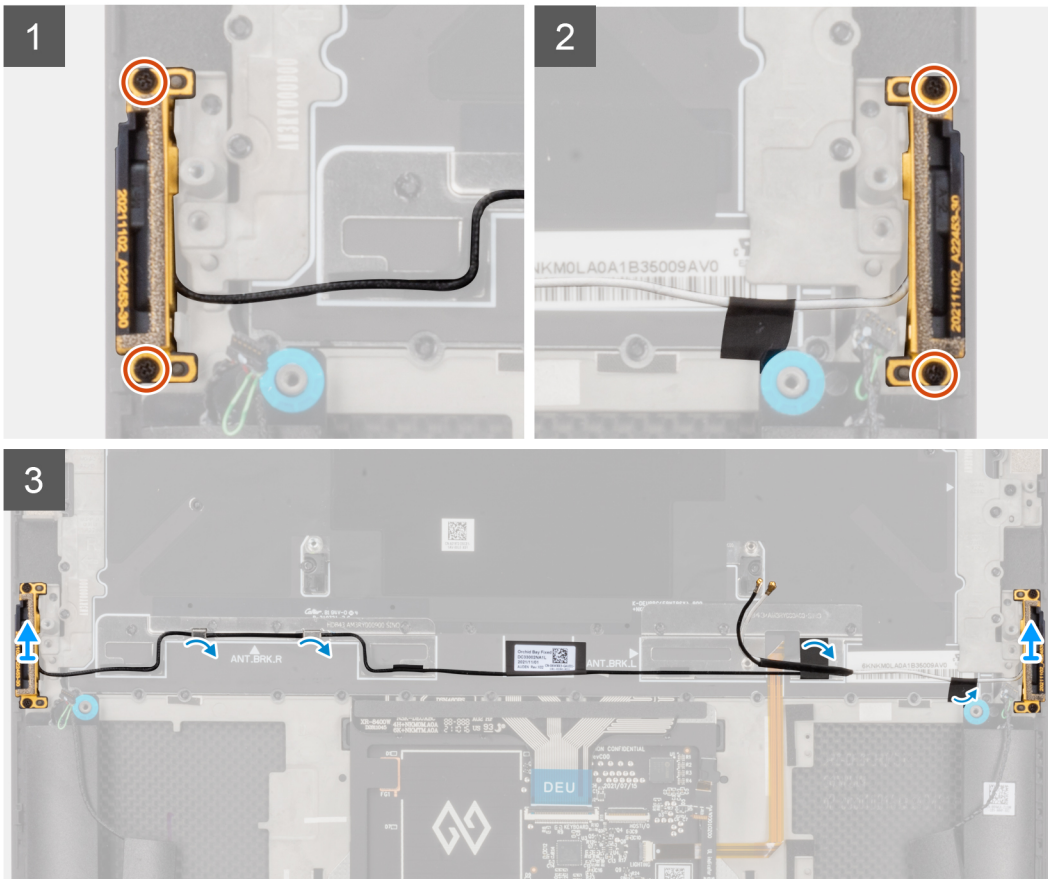
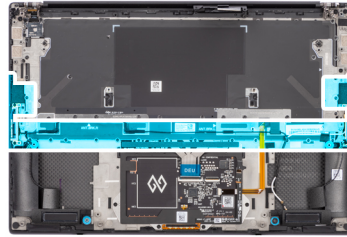

Steps

1. Remove the two (M1.4x2.5) captive screws that secure the auxiliary antenna on the palm-rest and keyboard assembly.
2. Remove the two (M1.4x2.5) captive screws that secure the main antenna on the palm-rest and keyboard assembly.
3. Peel the adhesives securing the auxiliary and main antennas to the palm-rest and keyboard assembly.
4. Unroute the auxiliary and main antennas from the routing guides on the palm-rest and keyboard assembly.
5. Lift to remove the auxiliary and main antennas from the palm-rest and keyboard assembly.

Installing the WLAN antennas

Prerequisites

If you are replacing a component, remove the existing component before performing the installation procedure.

About this task

The figure indicates the location of the WLAN antennas and provides a visual representation of the installation procedure.



4x
M1.4x2.5

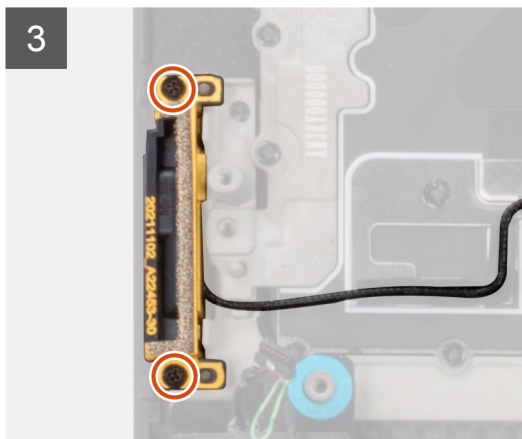
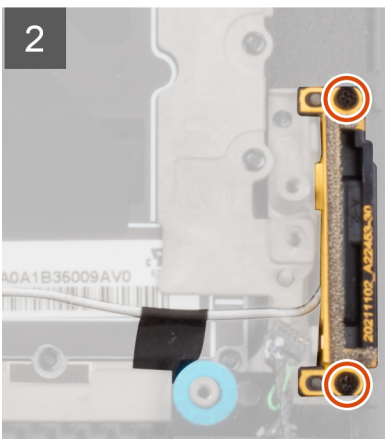
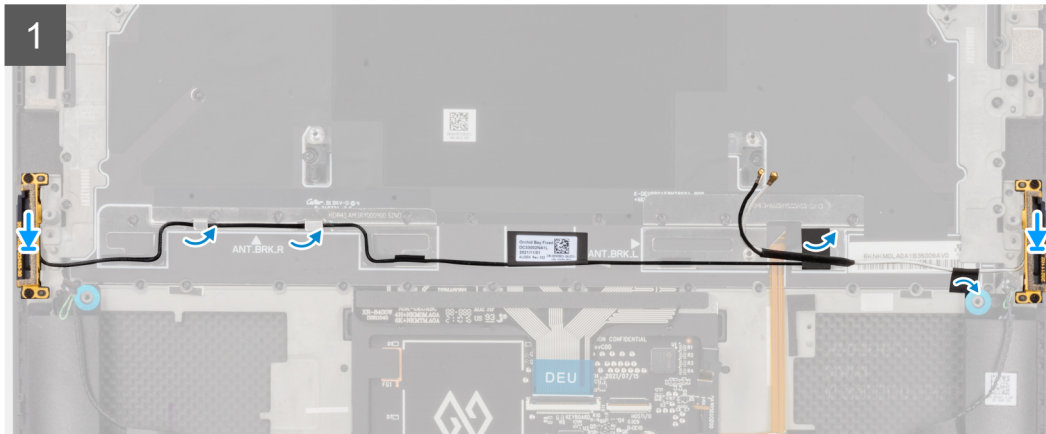
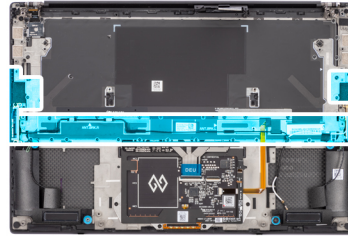

Steps

1. Align and place the auxiliary and main antennas into its slot on the palm-rest and keyboard assembly.
2. Reroute the auxiliary and main antennas using the routing guides on the palm-rest and keyboard assembly.
3. Adhere the tapes securing the auxiliary and main antennas to the palm-rest and keyboard assembly.
4. Replace the two (M1.4x2.5) captive screws that secure the main antenna on the palm-rest and keyboard assembly.
5. Replace the two (M1.4x2.5) captive screws that secure the auxiliary antenna on the palm-rest and keyboard assembly.

Next steps

1. Install the [system board](#).
2. Install the [audio jack](#).
3. Install the [right fan](#).
4. Install the [left fan](#).
5. Install the [battery](#).
6. Install the [M.2 2230 solid state drive](#) or [M.2 2280 solid state drive](#).
7. Install the [base cover](#).
8. Follow the procedure in [after working inside your computer](#).

Palm-rest and keyboard assembly

Removing the palm-rest and keyboard assembly

Prerequisites

1. Follow the procedure in [before working inside your computer](#).
2. Remove the [base cover](#).
3. Remove the [M.2 2230 solid state drive](#) or [M.2 2280 solid state drive](#).
4. Remove the [battery](#).
5. Remove the [left fan](#).
6. Remove the [right fan](#).
7. Remove the [audio jack](#).
8. Remove the [speakers](#).
9. Remove the [display assembly](#).
10. Remove the [system board](#).

i **NOTE:** The system board can be removed or installed together with the heat-sink attached. This simplifies the procedure and avoids breaking the thermal bond between the system board and the heat-sink.

11. Remove the [power button board with finger print reader](#).
12. Remove the [WLAN antennas](#).

About this task

The following image indicates the palm-rest and keyboard assembly and provides a visual representation of the removal procedure

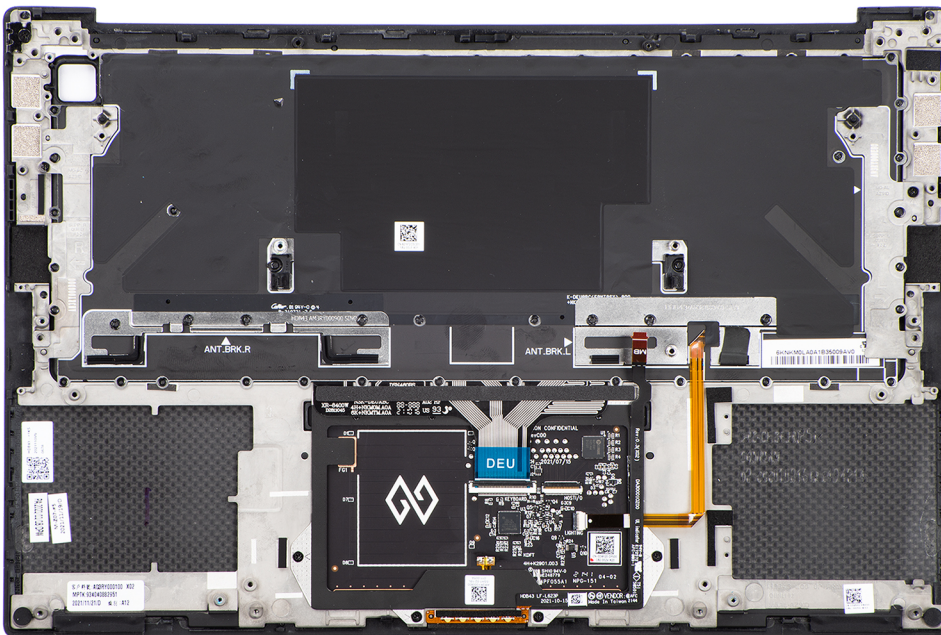

Steps

After performing the steps in the pre-requisites, we are left with the palm-rest and keyboard assembly.

Installing the palm-rest and keyboard assembly

Prerequisites

If you are replacing a component, remove the existing component before performing the installation procedure.

About this task

The following image indicates the palm-rest and keyboard assembly and provides a visual representation of the installation procedure.

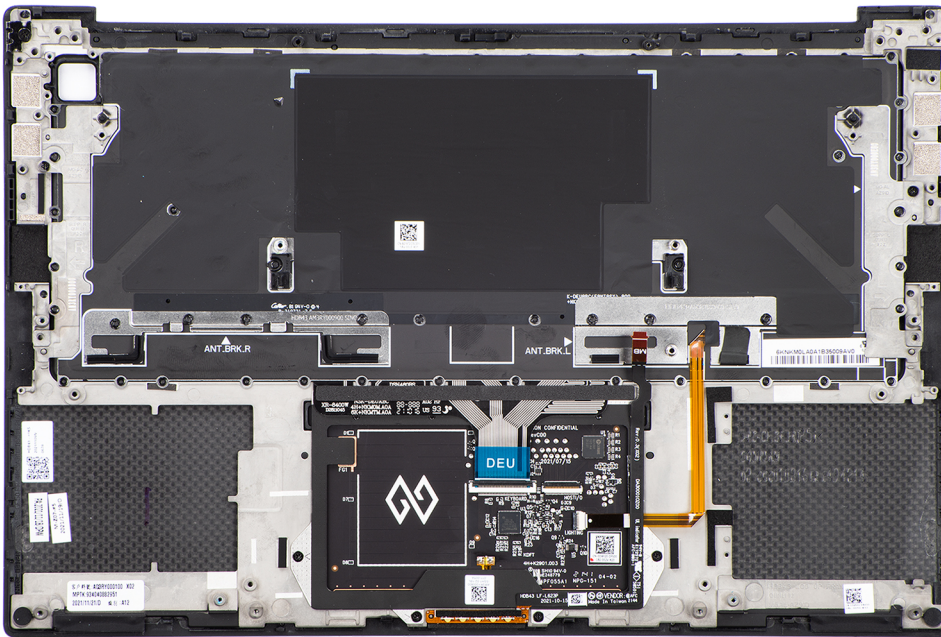

Steps

1. Place the palm-rest assembly on a flat surface.
2. Perform the steps in the post-requisites.

Next steps

1. Install the [WLAN antennas](#).
2. Install the [power-button board with finger print reader](#).
3. Install the [system board](#).
4. Install the [display assembly](#).
5. Install the [speakers](#).
6. Install the [audio jack](#).
7. Install the [right fan](#).
8. Install the [left fan](#).
9. Install the [battery](#).
10. Install the [M.2 2230 solid state drive](#) or [M.2 2280 solid state drive](#).
11. Install the [base cover](#).
12. Follow the procedure in [after working inside your computer](#).

Drivers and downloads

When troubleshooting, downloading or installing drivers it is recommended that you read the Dell Knowledge Base article, Drivers and Downloads FAQ [000123347](#).

BIOS setup

CAUTION: Unless you are an expert computer user, do not change the settings in the BIOS Setup program. Certain changes can make your computer work incorrectly.

NOTE: Depending on the computer and its installed devices, the items listed in this section may or may not be displayed.

NOTE: Before you change BIOS Setup program, it is recommended that you write down the BIOS Setup program screen information for future reference.

Use the BIOS Setup program for the following purposes:

- Get information about the hardware installed in your computer, such as the amount of RAM and the size of the hard drive.
- Change the system configuration information.
- Set or change a user-selectable option, such as the user password, type of hard drive installed, and enabling or disabling base devices.

BIOS overview

The BIOS manages data flow between the computer's operating system and attached devices such as hard disk, video adapter, keyboard, mouse, and printer.

Entering BIOS setup program

Steps

1. Turn on your computer.
2. Press F2 immediately to enter the BIOS setup program.

NOTE: If you wait too long and the operating system logo appears, continue to wait until you see the desktop. Then, turn off your computer and try again.

Navigation keys

NOTE: For most of the System Setup options, changes that you make are recorded but do not take effect until you restart the system.

Table 2. Navigation keys

Keys	Navigation
Up arrow	Moves to the previous field.
Down arrow	Moves to the next field.
Enter	Selects a value in the selected field (if applicable) or follow the link in the field.
Spacebar	Expands or collapses a drop-down list, if applicable.
Tab	Moves to the next focus area. NOTE: For the standard graphics browser only.

Table 2. Navigation keys (continued)

Keys	Navigation
Esc	Moves to the previous page until you view the main screen. Pressing Esc in the main screen displays a message that prompts you to save any unsaved changes and restarts the system.

One Time Boot menu

To enter **One Time Boot menu**, turn on your computer, and then press F12 immediately.

i **NOTE:** It is recommended to shutdown the computer if it is on.

The one-time boot menu displays the devices that you can boot from including the diagnostic option. The boot menu options are:

- Removable Drive (if available)
- STXXXX Drive (if available)
i **NOTE:** XXX denotes the SATA drive number.
- Optical Drive (if available)
- SATA Hard Drive (if available)
- Diagnostics

The boot sequence screen also displays the option to access the System Setup screen.

BIOS setup options

i **NOTE:** Depending on this computer and its installed devices, the items that are listed in this section may or may not appear.

Table 3. BIOS setup options—System information menu

Overview	
Precision 5480	
BIOS Version	Displays the BIOS version number.
Service Tag	Displays the Service Tag of the computer.
Asset Tag	Displays the Asset Tag of the computer.
Manufacturing Date	Displays the manufacture date of the computer.
Ownership Date	Displays the ownership date of the computer.
Express Service Code	Displays the express service code of the computer.
Ownership Tag	Displays the ownership tag of the computer.
Signed Firmware Update	Displays whether the Signed Firmware Update is enabled on your system.
Battery	
Primary	Displays that battery is primary.
Battery Level	Displays the battery level of the system.
Battery State	Displays the battery state of the system.
Health	Displays the battery health of the system.
AC Adapter	Displays whether the AC adapter is connected or not.
Battery Life Type	Displays the battery life type of the system.
Processor	

Table 3. BIOS setup options—System information menu (continued)

Overview	
Processor Type	Displays the processor type.
Maximum Clock Speed	Displays the maximum processor clock speed.
Minimum Clock Speed	Displays the minimum processor clock speed.
Current Clock Speed	Displays the current processor clock speed.
Core Count	Displays the number of cores on the processor.
Processor ID	Displays the processor identification code.
Processor L2 Cache	Displays the processor L2 Cache size.
Processor L3 Cache	Displays the processor L3 Cache size.
Microcode Version	Displays the microcode version.
Intel Hyper-Threading Capable	Displays whether the processor is Hyper-Threading (HT) capable.
64-Bit Technology	Displays whether 64-bit technology is used.
Memory	
Memory Installed	Displays the total system memory installed.
Memory Available	Displays the total system memory available.
Memory Speed	Displays the memory speed.
Memory Channel Mode	Displays single or dual channel mode.
Memory Technology	Displays the technology that is used for the memory.
Devices	
Panel Type	Displays the Panel Type of the system.
Video Controller	Displays the video controller type of the system.
Video Memory	Displays the video memory information of the system.
Wi-Fi Device	Displays the wireless device information of the system.
Native Resolution	Displays the native resolution of the system.
Video BIOS Version	Displays the video BIOS version of the system.
Audio Controller	Displays the audio controller information of the system.
Bluetooth Device	Displays the Bluetooth device information of the system.
Passthrough MAC Address	Displays the unique MAC address information of the computer.
dGPU Video Controller	Displays the discrete graphics information of the computer.

Table 4. System setup options—Boot Configuration menu

Boot Configuration	
Boot Sequence	
Boot mode	Displays the boot mode.
Boot Sequence	Displays the boot sequence.
Secure Digital (SD) Card Boot	Enable or disable the SD card read-only boot. By default, the Secure Digital (SD) Card Boot option is not enabled.
Secure Boot	
Enable Secure Boot	Enable or disable the secure boot feature. By default, the option is not enabled.
Enable Microsoft UEFI CA	Enable or disable the Microsoft UEFI CA feature.

Table 4. System setup options—Boot Configuration menu (continued)

Boot Configuration	
	By default, the option is enabled.
Secure Boot Mode	Enable or disable to change the secure boot mode options. By default, the Deployed Mode is enabled.
Expert Key Management	
Enable Custom Mode	Enable or disable custom mode. By default, the custom mode option is not enabled.
Custom Mode Key Management	Select the custom values for expert key management. By default, the PK option is enabled.

Table 5. System setup options—Integrated Devices menu

Integrated Devices	
Date/Time	Displays the current date in MM/DD/YYYY format and current time in HH:MM:SS AM/PM format.
Camera	Enable or disable the camera. By default, the Enable Camera option is enabled.
Audio	
Enable Audio	Enable or disable the integrated audio controller. By default, all the options are enabled.
USB/Thunderbolt Configuration	<ul style="list-style-type: none"> Enable or disable booting from USB mass storage devices that are connected to external USB ports. By default, the Enable External USB Ports option is enabled. Enable or disable booting from USB mass storage devices such as external hard drive, optical drive, and USB drive. By default, the Enable USB Boot Support option is enabled.
Enable Thunderbolt Technology Support	Enable or disable the associated ports and adapters. By default, the Enable Thunderbolt Technology Support option is enabled.
Enable Thunderbolt Boot Support	Enable or disable the Thunderbolt adapter-peripheral device and USB devices that are connected to the Thunderbolt adapter to be used during BIOS Pre-boot. By default, the Enable Thunderbolt Boot Support option is disabled.
Enable Thunderbolt (and PCIe behind TBT) pre-boot modules	Enable or disable the PCIe devices that are connected through a Thunderbolt adapter to run the PCIe devices UEFI Option ROM (if present) during pre-boot. By default, the Enable Thunderbolt (and PCIe behind TBT) pre-boot modules option is disabled.
Disable USB4 PCIE Tunneling	Disable the USB4 PCIE Tunneling option. By default, the option is disabled.
Video/Power only on Type-C Ports	Enable or disable the Type-C port functionality to video or only power. By default, the Video/Power only on Type-C Ports option is disabled.
Type-C Dock Override	Enable to use connected Type-C Dell Dock to provide data stream with external USB ports disabled. When Type-C Dock Override is enabled, the Audio/Lan submenu is activated.

Table 5. System setup options—Integrated Devices menu (continued)

Integrated Devices	
Type-C Dock Audio	By default, the Type-C Dock Override option is enabled. Enable or disable the usage of audio on Dell Dock external ports. By default, the Audio option is enabled.
Type-C Dock Lan	Enable or disable the usage of LAN on Dell Dock external ports. By default, the Lan option is enabled.
Miscellaneous Devices	Enable or disable Fingerprint Reader device. By default, the Enable Fingerprint Reader Device option is enabled.
Unobtrusive Mode	When the feature is enabled it turns off all system light and sound. By default, the option is disabled.

Table 6. System setup options—Storage menu

Storage	
SATA/NVMe Operation	
SATA/NVMe Operation	Set the operating mode of the integrated storage device controller. By default, the RAID On option is enabled.
Storage interface	
Port Enablement	This page allows you to enable the onboard drives. By default, the M.2 PCIe SSD option is enabled.
SMART Reporting	
Enable SMART Reporting	Enable or disable Self-Monitoring, Analysis, and Reporting Technology (SMART) during system startup. By default, the Enable SMART Reporting option is not enabled.
Drive Information	
M.2 PCIe SSD	
Type	Displays the M.2 PCIe SSD type information of the system.
Device	Displays the M.2 PCIe SSD device information of the system.
Enable MediaCard	
Secure Digital (SD) Card	Enable or disable the SD card. By default, the Secure Digital (SD) Card option is enabled.
Secure Digital (SD) Card Read-Only Mode	Enable or disable the SD card read-only mode. By default, the Secure Digital (SD) Card Read-Only Mode option is disabled.

Table 7. System setup options—Display menu

Display	
Display Brightness	
Brightness on battery power	Enable to set screen brightness when the system is running on battery power.
Brightness on AC power	Enable to set screen brightness when the system is running on AC power.
Touchscreen	
Touchscreen	Enable or disable the touchscreen for the OS.

Table 7. System setup options—Display menu (continued)

Display	
	By default, the option is enabled.
Full Screen Logo	Enable or disable full screen logo. By default, the option is disabled.

Table 8. System setup options—Connection menu

Connection	
Wireless Device Enable	
WLAN	Enable or disable the internal WLAN device. By default, the option enabled.
Bluetooth	Enable or disable the internal Bluetooth device By default, the option enabled.
Contactless smartcard/NFC	Enable or disable the internal Contactless smartcard/NFC device By default, the option enabled.
Enable UEFI Network Stack	Enable or disable UEFI Network Stack and controls the on-board LAN Controller. By default, the Enabled option is selected.
Wireless Radio Control	
Control WLAN radio	Sense the connection of the system to a wired network and subsequently disable the selected wireless radios (WLAN). By default, the option is disabled.
HTTPs Boot Feature	
HTTPs Boot	Enable or disable the HTTPs Boot feature. By default, the ON option is enabled.
HTTPs Boot Mode	With Auto Mode, the HTTPs Boot extracts Boot URL from the DHCP. With Manual Mode, the HTTPs Boot reads Boot URL from the user-provided data. By default, the Auto Mode option is enabled.

Table 9. System setup options—Power menu

Power	
Battery Configuration	Enables the system to run on battery during peak power usage hours. Use the table Custom Charge Start and Custom Charge Stop to prevent AC power usage between certain times of each day. By default, the Adaptive option is enabled.
Advanced Configuration	
Enable Advanced Battery Charge Configuration	Enable or disable the advanced battery charge configuration. By default, the Enable Advanced Battery Charge Configuration option is disabled.
Peak Shift	
Enable Peak Shift	Enables the system to run on battery during peak power usage hours. By default, the Enable Peak Shift option is disabled.
Thermal Management	
	Enables to cool the fan and processor heat management to adjust the system performance, noise, and temperature.

Table 9. System setup options—Power menu (continued)

Power	
	By default, the Optimized option is enabled.
USB Wake Support	
Wake on Dell USB-C Dock	When enabled, connecting a Dell USB-C Dock will wake the system from Standby, Hibernate, and Power Off. By default, the Wake on Dell USB-C Dock option is enabled.
Block Sleep	Enable to block entering Sleep (S3) mode in the operating system. By default, the Block Sleep option is disabled.
Lid Switch	
Enable Lid Switch	Enable or disable the lid switch. By default, the Enable Lid Switch option is enabled.
Power On Lid Open	When enabled, allows the system to power up from the off state whenever the lid is opened. By default, the Power On Lid Open option is enabled.
Intel Speed Shift Technology	Enable or disable the Intel Speed Shift Technology support. By default, the Intel Speed Shift Technology option is enabled.

Table 10. System setup options—Security menu

Security	
TPM 2.0 Security	
TPM 2.0 Security On	Allows you to enable or disable TPM visibility to operating system. By default, the TPM 2.0 Security On option is enabled.
Attestation Enable	Enable to control whether the Trusted Platform Module (TPM) Endorsement Hierarchy is available to the operating system. By default, the Attestation Enable option is enabled.
Key Storage Enable	Enable to control whether the Trusted Platform Module (TPM) Storage Hierarchy is available to the operating system. By default, the Key Storage Enable option is enabled.
SHA-256	When enabled, the BIOS and TPM will use the SHA-256 hash algorithm to extend measurements into the TPM PCRs during BIOS boot. By default, the SHA-256 option is enabled.
Clear	Enable to clear the TPM owner information and returns the TPM to the default state. By default, the Clear option is disabled.
PPI Bypass for Clear Commands	Controls the TPM Physical Presence Interface (PPI). By default, the PPI Bypass for Clear Commands option is disabled.
Intel Total Memory Encryption	
Total Memory Encryption	Enable or disable you to protect memory from physical attacks including freeze spray, probing DDR to read the cycles, and others. By default, the Total Memory Encryption option is disabled.
Chassis intrusion	Controls the chassis intrusion feature. By default, the option is disabled. When the computer is shipped, the On-Silent option is enabled.

Table 10. System setup options—Security menu (continued)



Security	
Block Boot Until Cleared	when the Block Boot Until Cleared option is enabled, you may not be able to boot until returning to this page to clear the warning. If an Admin Password is set, you need to unlock setup to clear the warning.
SMM Security Mitigation	Enable or disable additional UEFI SMM Security Mitigation protections. By default, the option is enabled.
Data Wipe on Next Boot	
Start Data Wipe	Enable or disable the data wipe on next boot. By default, the Start Data Wipe option is disabled.
Absolute	Enable, disable, or permanently disable the BIOS module interface of the optional Absolute Persistence Module service from Absolute Software. By default, the option is enabled.
	<p> WARNING: The 'Permanently Disabled' option can only be selected once. When 'Permanently Disabled' is selected, Absolute Persistence cannot be re-enabled. No further changes to the Enable/Disable states are allowed.</p> <p> NOTE: The Enable/Disable options are unavailable while Computrace is in the activated state.</p>
UEFI Boot Path Security	Controls whether the system prompts the user to enter the admin password (if set) when booting to a UEFI boot path device from the F12 boot menu. By default, the Always Except Internal HDD option is enabled.
Firmware Device Tamper Detection	
Firmware Device Tamper Detection	By default, the Silent option is enabled.
Clear Firmware Device Tamper Detection	By default, the option is disabled.

Table 11. System setup options—Passwords menu

Passwords	
Admin Password	Set, change, or delete the administrator password.
System Password	Set, change, or delete the system password.
M.2 PCIe SSD-1	Set, change, or delete the NVMe SSD-0 password.
Password Configuration	
Upper Case Letter	Reinforces password must have at least one upper case letter. By default, the option is disabled.
Lower Case Letter	Reinforces password must have at least one lower case letter. By default, the option is disabled.
Digit	Reinforces password must have at least one digit number. By default, the option is disabled.
Special Character	Reinforces password must have at least one special character. By default, the option is disabled.
Minimum Characters	Set the minimum characters allowed for password.
Password Bypass	When enabled, this always prompts for system and internal hard drive passwords when powered on from the Off state.

Table 11. System setup options—Passwords menu (continued)

Passwords	
	By default, the Disabled option is selected.
Password Changes	
Allow Non-Admin Password Changes	Enable or disable to change system and hard drive password without the need for admin password. By default, the option is enabled.
Admin Setup Lockout	
Enable Admin Setup Lockout	Enables administrators control over how their users can or cannot access BIOS setup. By default, the option is disabled.
Master Password Lockout	
Enable Master Password Lockout	When enabled, this disables the master password support. By default, the option is disabled.
Allow Non-Admin PSID Revert	
Enable Allow Non-Admin PSID Revert	Controls access to the Physical Security ID (PSID) revert of NVMe hard-drives from the Dell Security Manager prompt. By default, the option is disabled.

Table 12. System setup options—Update, Recovery menu

Update, Recovery	
UEFI Capsule Firmware Updates	Enable or disable BIOS updates through UEFI capsule update packages. i NOTE: Disabling this option blocks BIOS updates from services such as Microsoft Windows Update and Linux Vendor Firmware Service (LVFS). By default, the option is enabled.
BIOS Recovery from Hard Drive	Enables the user to recover from certain corrupted BIOS conditions from a recovery file on the user primary hard drive or an external USB key. By default, the option is enabled. i NOTE: BIOS Recovery from Hard Drive is not available for self-encrypting drives (SED).
BIOS Downgrade	
Allow BIOS Downgrade	This field controls the flashing of the system firmware to previous revisions. By default, the option is enabled.
SupportAssist OS Recovery	Enable or disable the boot flow for SupportAssist OS Recovery tool in the event of certain system errors. By default, the option is enabled.
BIOSConnect	Enable or disable cloud Service operating system recovery if the main operating system fails to boot with the number of failures equal to or greater than the value specified by the Auto operating system Recovery Threshold setup option and local Service operating system does not boot or is not installed. By default, the option is enabled.
Dell Auto OS Recovery Threshold	Controls the automatic boot flow for SupportAssist System Resolution Console and for Dell operating system Recovery Tool. By default, the threshold value is set to 2.

Table 13. System setup options—System Management menu

System Management	
Service Tag	Displays the Service Tag of the system.
Asset Tag	Create a system Asset Tag.
AC Behavior	
Wake on AC	Enable or disable the wake on AC option. By default, the option is disabled.
Wake on LAN	
Wake on LAN	Enable or disable the system to power on by special LAN signals when it receives a wakeup signal from the WLAN. By default, the Disabled option is selected.
Auto on Time	Enable to set the system to turn on automatically every day or on a preselected date and time. This option can be configured only if the Auto On Time is set to Everyday, Weekdays, or Selected Days. By default, the option is disabled.
Intel AMT Capability	
Enable Intel AMT Capability	By default Restrict Preboot Access option is enabled.
Diagnostics	
OS Agent Requests	By default OS Agent Requests option is enabled.
Power-on-Self-Test Automatic Recovery	
Power-on-Self-Test Automatic Recovery	By default Power-on-Self-Test Automatic Recovery option is enabled.

Table 14. System setup options—Keyboard menu

Keyboard	
Fn Lock Options	By default, the Fn lock option is enabled.
Lock Mode	By default, the Lock Mode Secondary option is enabled. With this option, the F1-F2 keys scan the code for their secondary functions.
Keyboard Illumination	Enable to change the keyboard illumination settings. By default, the Keyboard Illumination option is disabled.
Keyboard Backlight Timeout on AC	Set the timeout value for the keyboard backlight when an AC adapter is connected to the system. By default, the 10 seconds option is enabled.
Keyboard Backlight Timeout on Battery	Set the timeout value for the keyboard backlight when the is running only on battery power. By default, the 10 seconds option is enabled.
Device Configuration Hotkey Access	Manages whether you can access device configuration screens through hotkeys during system startup. By default, the option is enabled.

Table 15. System setup options—Pre-boot Behavior menu

Pre-boot Behavior	
Adapter Warnings	
Enable Adapter Warnings	Enable or disable the warning messages during boot when the adapters with less power capacity are detected.

Table 15. System setup options—Pre-boot Behavior menu (continued)

Pre-boot Behavior	
Warning and Errors	By default, the option is enabled. Enable or disable the action to be done when a warning or error is encountered. By default, the Prompt on Warnings and Errors option is enabled.
USB-C Warnings	
Enable Dock Warning Messages	By default, the option is enabled.
Fastboot	Allows you to configure the speed of the UEFI boot process. By default, the Minimal option is enabled.
Extend BIOS POST Time	Set the BIOS POST load time. By default, the 0 seconds option is enabled.
MAC Address Pass-Through	Replaces the external NIC MAC address with the selected MAC address from the system. By default, the Passthrough MAC Address option is enabled.
Sign of Life	
Early Keyboard Backlight	By default, the option is enabled.

Table 16. System setup options—Virtualization menu

Virtualization	
Intel Virtualization Technology	
Enable Intel Virtualization Technology (VT)	When enabled, the system can run a Virtual Machine Monitor (VMM). By default, the option is enabled.
VT for Direct I/O	When enabled, the system can perform Virtualization Technology for Direct I/O (VT-d). By default, the option is enabled.
Intel Trusted Execution Technology (TXT)	
Enable Intel Trusted Execution Technology (TXT)	Specifies whether a measured Virtual Machine Monitor (MVMM) can use the additional hardware capabilities that are provided by Intel Trusted Execution Technology. The following must be enabled in order to enable Intel TXT. <ul style="list-style-type: none"> • Trusted Platform Module (TPM) • Intel Hyper-Threading • All CPU cores (Multi-Core Support) • Intel Virtualization Technology • Intel VT for Direct I/O By default, the option is disabled.
DMA Protection	
Enable Pre-Boot DMA Support	This setting controls Pre-boot DMA protection for both internal and external ports. By default, the option is enabled.
Enable OS Kernel DMA Support	This setting controls Kernel DMA protection for both internal and external ports. By default, the option is enabled.

Table 17. System setup options—Performance menu

Performance	
Multi Core Support	
Active Cores	Enables to change the number of CPU cores available to the operating system. By default, the All Cores option is enabled.
Multiple Atom Cores	Enables to change the number of Atom cores available to the operating system. By default, the All Cores option is enabled.
Intel SpeedStep	
Enable Intel SpeedStep Technology	Enables the system to dynamically adjust processor voltage and core frequency, decreasing average power consumption and heat production. By default, the option is enabled.
C-States Control	
Enable C-State Control	Enables the ability of the CPU to enter and exit low power state. When disabled, it disabled all C-states. When enabled, it enabled all C-states that the chipset or platform allows. By default, the option is enabled.
Enable Adaptive C-States for Discrete Graphics	By default, the option is enabled.
Intel Turbo Boost Technology	
Enable Intel Turbo Boost Technology	Enable or disable the Intel TurboBoost mode of the processor. By default, the option is enabled.
Intel Turbo Boost Maximum Technology 3.0	
Enable Intel Turbo Boost Maximum Technology 3.0	Enable or disable the Intel TurboBoost maximum mode of the processor. By default, the option is disabled.
Intel Hyper-Threading Technology	
Enable Intel Hyper-Threading Technology	Enable or disable Hyper-Threading in the processor. By default, the option is enabled.

Table 18. System setup options—System Logs menu

System Logs	
BIOS Event Log	
Clear Bios Event Log	Displays BIOS events. By default, the Keep Log option is enabled.
Thermal Event Log	
Clear Thermal Event Log	Displays Thermal events. By default, the Keep Log option is enabled.
Power Event Log	
Clear Power Event Log	Displays power events. By default, the Keep Log option is enabled.

Table 19. System setup options—About

About	
License Information	Displays the license information of the system.

Updating the BIOS

Updating the BIOS in Windows

About this task

CAUTION: If BitLocker is not suspended before updating the BIOS, the next time you reboot the system it will not recognize the BitLocker key. You will then be prompted to enter the recovery key to progress and the system will ask for this on each reboot. If the recovery key is not known this can result in data loss or an unnecessary operating system re-install. For more information on this subject, search in the Knowledge Base Resource at www.dell.com/support.

Steps

1. Go to www.dell.com/support.
2. Click **Product support**. In the **Search support** box, enter the Service Tag of your computer, and then click **Search**.
NOTE: If you do not have the Service Tag, use the SupportAssist feature to automatically identify your computer. You can also use the product ID or manually browse for your computer model.
3. Click **Drivers & Downloads**. Expand **Find drivers**.
4. Select the operating system installed on your computer.
5. In the **Category** drop-down list, select **BIOS**.
6. Select the latest version of BIOS, and click **Download** to download the BIOS file for your computer.
7. After the download is complete, browse the folder where you saved the BIOS update file.
8. Double-click the BIOS update file icon and follow the on-screen instructions.
For more information, search in the Knowledge Base Resource at www.dell.com/support.

Updating the BIOS in Linux and Ubuntu

To update the system BIOS on a computer that is installed with Linux or Ubuntu, see the knowledge base article [000131486](http://www.dell.com/support) at www.dell.com/support.

Updating the BIOS using the USB drive in Windows

About this task

CAUTION: If BitLocker is not suspended before updating the BIOS, the next time you reboot the system it will not recognize the BitLocker key. You will then be prompted to enter the recovery key to progress and the system will ask for this on each reboot. If the recovery key is not known this can result in data loss or an unnecessary operating system re-install. For more information on this subject, search in the Knowledge Base Resource at www.dell.com/support.

Steps

1. Follow the procedure from step 1 to step 6 in [Updating the BIOS in Windows](#) to download the latest BIOS setup program file.
2. Create a bootable USB drive. For more information, search in the Knowledge Base Resource at www.dell.com/support.
3. Copy the BIOS setup program file to the bootable USB drive.
4. Connect the bootable USB drive to the computer that needs the BIOS update.

5. Restart the computer and press **F12** .
6. Select the USB drive from the **One Time Boot Menu**.
7. Type the BIOS setup program filename and press **Enter**.
The **BIOS Update Utility** appears.
8. Follow the on-screen instructions to complete the BIOS update.

Updating the BIOS from the F12 One-Time boot menu

Update your computer BIOS using the BIOS update.exe file that is copied to a FAT32 USB drive and booting from the F12 One-Time boot menu.

About this task

 **CAUTION:** If BitLocker is not suspended before updating the BIOS, the next time you reboot the system it will not recognize the BitLocker key. You will then be prompted to enter the recovery key to progress and the system will ask for this on each reboot. If the recovery key is not known this can result in data loss or an unnecessary operating system re-install. For more information on this subject, search in the Knowledge Base Resource at www.dell.com/support.

BIOS Update

You can run the BIOS update file from Windows using a bootable USB drive or you can also update the BIOS from the F12 One-Time boot menu on the computer.

Most of the Dell computers built after 2012 have this capability, and you can confirm by booting your computer to the F12 One-Time Boot Menu to see if BIOS FLASH UPDATE is listed as a boot option for your computer. If the option is listed, then the BIOS supports this BIOS update option.

 **NOTE:** Only computers with BIOS Flash Update option in the F12 One-Time boot menu can use this function.

Updating from the One-Time boot menu

To update your BIOS from the F12 One-Time boot menu, you need the following:

- USB drive formatted to the FAT32 file system (key does not have to be bootable)
- BIOS executable file that you downloaded from the Dell Support website and copied to the root of the USB drive
- AC power adapter that is connected to the computer
- Functional computer battery to flash the BIOS

Perform the following steps to perform the BIOS update flash process from the F12 menu:

 **CAUTION:** Do not turn off the computer during the BIOS update process. The computer may not boot if you turn off your computer.

Steps

1. From a turn off state, insert the USB drive where you copied the flash into a USB port of the computer.
2. Turn on the computer and press F12 to access the One-Time Boot Menu, select BIOS Update using the mouse or arrow keys then press Enter.
The flash BIOS menu is displayed.
3. Click **Flash from file**.
4. Select external USB device.
5. Select the file and double-click the flash target file, and then click **Submit**.
6. Click **Update BIOS**. The computer restarts to flash the BIOS.
7. The computer will restart after the BIOS update is completed.

System and setup password

Table 20. System and setup password

Password type	Description
System password	Password that you must enter to log in to your system.
Setup password	Password that you must enter to access and make changes to the BIOS settings of your computer.

You can create a system password and a setup password to secure your computer.

 **CAUTION:** The password features provide a basic level of security for the data on your computer.

 **CAUTION:** Anyone can access the data that is stored on your computer if it is not locked and left unattended.

 **NOTE:** System and setup password feature is disabled.

Assigning a system setup password

Prerequisites

You can assign a new **System or Admin Password** only when the status is in **Not Set**.

About this task

To enter the system setup, press F12 immediately after a power-on or reboot.

Steps

1. In the **System BIOS** or **System Setup** screen, select **Security** and press Enter.
The **Security** screen is displayed.
2. Select **System/Admin Password** and create a password in the **Enter the new password** field.
Use the following guidelines to assign the system password:
 - A password can have up to 32 characters.
 - At least one special character: ! " # \$ % & ' () * + , - . / : ; < = > ? @ [\] ^ _ ` { | }
 - Numbers 0 through 9.
 - Upper case letters from A to Z.
 - Lower case letters from a to z.
3. Type the system password that you entered earlier in the **Confirm new password** field and click **OK**.
4. Press Esc and save the changes as prompted by the pop-up message.
5. Press Y to save the changes.
The computer restarts.

Deleting or changing an existing system setup password

Prerequisites

Ensure that the **Password Status** is Unlocked (in the System Setup) before attempting to delete or change the existing System and/or Setup password. You cannot delete or change an existing System or Setup password, if the **Password Status** is Locked.

About this task

To enter the System Setup, press F12 immediately after a power-on or reboot.

Steps

1. In the **System BIOS** or **System Setup** screen, select **System Security** and press Enter.
The **System Security** screen is displayed.
2. In the **System Security** screen, verify that **Password Status** is **Unlocked**.
3. Select **System Password**, update, or delete the existing system password, and press Enter or Tab.
4. Select **Setup Password**, update, or delete the existing setup password, and press Enter or Tab.
 **NOTE:** If you change the System and/or Setup password, reenter the new password when prompted. If you delete the System and/or Setup password, confirm the deletion when prompted.
5. Press Esc and a message prompts you to save the changes.
6. Press Y to save the changes and exit from System Setup.
The computer restarts.

Clearing BIOS (System Setup) and System passwords

About this task

To clear the system or BIOS passwords, contact Dell technical support as described at www.dell.com/contactdell.

-  **NOTE:** For information on how to reset Windows or application passwords, refer to the documentation accompanying Windows or your application.

Troubleshooting

Handling swollen Lithium-ion batteries

Like most laptops, Dell laptops use lithium-ion batteries. One type of lithium-ion battery is the lithium-ion polymer battery. Lithium-ion polymer batteries have increased in popularity in recent years and have become standard in the electronics industry due to customer preferences for a slim form factor (especially with newer ultra-thin laptops) and long battery life. Inherent to lithium-ion polymer battery technology is the potential for swelling of the battery cells.

Swollen battery may impact the performance of the laptop. To prevent possible further damage to the device enclosure or internal components leading to malfunction, discontinue the use of the laptop and discharge it by disconnecting the AC adapter and letting the battery drain.

Swollen batteries should not be used and should be replaced and disposed of properly. We recommend contacting Dell product support for options to replace a swollen battery under the terms of the applicable warranty or service contract, including options for replacement by a Dell authorized service technician.

The guidelines for handling and replacing Lithium-ion batteries are as follows:

- Exercise caution when handling Lithium-ion batteries.
- Discharge the battery before removing it from the system. To discharge the battery, unplug the AC adapter from the system and operate the system only on battery power. When the system will no longer power on when the power button is pressed, the battery is fully discharged.
- Do not crush, drop, mutilate, or penetrate the battery with foreign objects.
- Do not expose the battery to high temperatures, or disassemble battery packs and cells.
- Do not apply pressure to the surface of the battery.
- Do not bend the battery.
- Do not use tools of any type to pry on or against the battery.
- If a battery gets stuck in a device as a result of swelling, do not try to free it as puncturing, bending, or crushing a battery can be dangerous.
- Do not attempt to reassemble a damaged or swollen battery into a laptop.
- Swollen batteries that are covered under warranty should be returned to Dell in an approved shipping container (provided by Dell)—this is to comply with transportation regulations. Swollen batteries that are not covered under warranty should be disposed of at an approved recycling center. Contact Dell product support at <https://www.dell.com/support> for assistance and further instructions.
- Using a non-Dell or incompatible battery may increase the risk of fire or explosion. Replace the battery only with a compatible battery purchased from Dell that is designed to work with your Dell computer. Do not use a battery from other computers with your computer. Always purchase genuine batteries from <https://www.dell.com> or otherwise directly from Dell.

Lithium-ion batteries can swell for various reasons such as age, number of charge cycles, or exposure to high heat. For more information on how to improve the performance and lifespan of the laptop battery and to minimize the possibility of occurrence of the issue, search Dell Laptop Battery in the Knowledge Base Resource at www.dell.com/support.

Dell SupportAssist Pre-boot System Performance Check diagnostics

About this task

SupportAssist diagnostics (also known as system diagnostics) performs a complete check of your hardware. The Dell SupportAssist Pre-boot System Performance Check diagnostics is embedded with the BIOS and is launched by the BIOS internally. The embedded system diagnostics provides a set of options for particular devices or device groups allowing you to:

- Run tests automatically or in an interactive mode
- Repeat tests
- Display or save test results

- Run thorough tests to introduce additional test options to provide extra information about the failed device(s)
- View status messages that inform you if tests are completed successfully
- View error messages that inform you of problems encountered during testing

NOTE: Some tests for specific devices require user interaction. Always ensure that you are present at the computer terminal when the diagnostic tests are performed.

For more information, see <https://www.dell.com/support/kbdoc/000180971>.

Running the SupportAssist Pre-Boot System Performance Check

Steps

1. Turn on your computer.
2. As the computer boots, press the F12 key as the Dell logo appears.
3. On the boot menu screen, select the **Diagnostics** option.
4. Click the arrow at the bottom left corner.
Diagnostics front page is displayed.
5. Click the arrow in the lower-right corner to go to the page listing.
The items detected are listed.
6. To run a diagnostic test on a specific device, press Esc and click **Yes** to stop the diagnostic test.
7. Select the device from the left pane and click **Run Tests**.
8. If there are any issues, error codes are displayed.
Note the error code and validation number and contact Dell.

Built-in self-test (BIST)

M-BIST

M-BIST (Built In Self-Test) is the system board's built-in self-test diagnostics tool that improves the diagnostics accuracy of system board embedded controller (EC) failures.

NOTE: M-BIST can be manually initiated before POST (Power On Self Test).

How to run M-BIST

NOTE: M-BIST must be initiated on the system from a power-off state either connected to AC power or with battery only.

1. Press and hold both the **M** key on the keyboard and the **power button** to initiate M-BIST.
2. With both the **M** key and the **power button** held down, the battery indicator LED may exhibit two states:
 - a. OFF: No fault detected with the system board
 - b. AMBER: Indicates a problem with the system board
3. If there is a failure with the system board, the battery status LED will flash one of the following error codes for 30 seconds:

Table 21. LED error codes

Blinking Pattern		Possible Problem
Amber	White	
2	1	CPU Failure
2	8	LCD Power Rail Failure
1	1	TPM Detection Failure
2	4	Memory/RAM failure

4. If there is no failure with the system board, the LCD will cycle through the solid color screens described in the LCD-BIST section for 30 seconds and then power off.

LCD Power rail test (L-BIST)

L-BIST is an enhancement to the single LED error code diagnostics and is automatically initiated during POST. L-BIST will check the LCD power rail. If there is no power being supplied to the LCD (that is if the L-BIST circuit fails), the battery status LED will flash either an error code [2,8] or an error code [2,7].

NOTE: If L-BIST fails, LCD-BIST cannot function as no power will be supplied to the LCD.

How to invoke L-BIST Test:

1. Press the power button to start the system.
2. If the system does not start up normally, look at the battery status LED:
 - If the battery status LED flashes an error code [2,7], the display cable may not be connected properly.
 - If the battery status LED flashes an error code [2,8], there is a failure on the LCD power rail of the system board, hence there is no power supplied to the LCD.
3. For cases, when a [2,7] error code is shown, check to see if the display cable is properly connected.
4. For cases when a [2,8] error code is shown, replace the system board.

LCD Built-in Self Test (BIST)

Dell laptops have a built-in diagnostic tool that helps you determine if the screen abnormality you are experiencing is an inherent problem with the LCD (screen) of the Dell laptop or with the video card (GPU) and PC settings.

When you notice screen abnormalities like flickering, distortion, clarity issues, fuzzy or blurry image, horizontal or vertical lines, color fade etc., it is always a good practice to isolate the LCD (screen) by running the Built-In Self Test (BIST).

How to invoke LCD BIST Test

1. Power off the Dell laptop.
2. Disconnect any peripherals that are connected to the laptop. Connect only the AC adapter (charger) to the laptop.
3. Ensure that the LCD (screen) is clean (no dust particles on the surface of the screen).
4. Press and hold **D** key and **Power on** the laptop to enter LCD built-in self test (BIST) mode. Continue to hold the D key, until the system boots up.
5. The screen will display solid colors and change colors on the entire screen to white, black, red, green, and blue twice.
6. Then it will display the colors white, black and red.
7. Carefully inspect the screen for abnormalities (any lines, fuzzy color or distortion on the screen).
8. At the end of the last solid color (red), the system will shut down.

NOTE: Dell SupportAssist Pre-boot diagnostics upon launch, initiates an LCD BIST first, expecting a user intervention confirm functionality of the LCD.

System-diagnostic lights

This section lists the system-diagnostic lights of your Precision 5480.

Table 22. System-diagnostic lights

Blinking pattern		Problem description	Suggested resolution
Amber	White		
1	1	TPM detection failure	Replace the system board.
1	2	Unrecoverable SPI Flash Failure	Replace the system board.
1	5	EC unable to program i-Fuse	Replace the system board.

Table 22. System-diagnostic lights (continued)

Blinking pattern		Problem description	Suggested resolution
Amber	White		
1	6	Generic catch-all for ungraceful EC code flow errors	Disconnect all power source (AC, battery, coin cell) and drain flea power by pressing and holding down power button for 3~5 seconds.
2	1	CPU failure	<ul style="list-style-type: none"> • Run the Dell Support Assist/Dell Diagnostics tool. • If problem persists, replace the system board.
2	2	System board failure (included BIOS corruption or ROM error)	<ul style="list-style-type: none"> • Flash latest BIOS version • If problem persists, replace the system board.
2	3	No memory/RAM detected	<ul style="list-style-type: none"> • Confirm that the memory module is installed properly. • If problem persists, replace the memory module.
2	4	Memory/RAM failure	<ul style="list-style-type: none"> • Reset and swap memory modules among the slots. • If problem persists, replace the memory module.
2	5	Invalid memory installed	<ul style="list-style-type: none"> • Reset and swap memory modules among the slots. • If problem persists, replace the memory module.
2	6	System board/Chipset Error	Replace the system board.
2	7	LCD failure (SBIOS message)	Replace the LCD module.
2	8	LCD failure (EC detection of power rail failure)	Replace the system board.
3	1	CMOS battery failure	<ul style="list-style-type: none"> • Reset the main battery connection. • If problem persists, replace the main battery.
3	2	PCI or Video card/chip failure	Replace the system board.
3	3	BIOS Recovery image not found	<ul style="list-style-type: none"> • Flash latest BIOS version • If problem persists, replace the system board.
3	4	BIOS Recovery image found but invalid	<ul style="list-style-type: none"> • Flash latest BIOS version • If problem persists, replace the system board.
3	5	Power rail failure	Replace the system board.
3	6	Flash corruption detected by SBIOS.	<ul style="list-style-type: none"> • Press power button for over 25 seconds to do

Table 22. System-diagnostic lights (continued)

Blinking pattern		Problem description	Suggested resolution
Amber	White		
			RTC reset. If problem persists, replace the system board. <ul style="list-style-type: none"> • Disconnect all power source (AC, battery, coin cell) and drain flea power by pressing and holding down power button 3~5 seconds to ensure all power are drained. • Run "BIOS recovery from USB", and the instructions are in the website Dell support. • If problem persists, replace the system board.
3	7	Timeout waiting on ME to reply to HECI message.	Replace the system board.

NOTE: Blinking 3-3-3 LEDs on Lock LED (Caps-Lock or Num-Lock), Power button LED (without Fingerprint reader), and Diagnostic LED indicates failure to provide input during LCD panel test on Dell SupportAssist Pre-boot System Performance. Check diagnostics.

Real-Time Clock (RTC Reset)

The Real Time Clock (RTC) reset function allows you or the service technician to recover Dell systems from No POST/No Power/No Boot situations. The legacy jumper enabled RTC reset has been retired on these models.

Start the RTC reset with the system powered off and connected to AC power. Press and hold the power button for thirty (30) seconds

. The system RTC Reset occurs after you release the power button.

Recovering the operating system

When your computer is unable to boot to the operating system even after repeated attempts, it automatically starts Dell SupportAssist OS Recovery.

Dell SupportAssist OS Recovery is a standalone tool that is preinstalled in all Dell computers installed with Windows operating system. It consists of tools to diagnose and troubleshoot issues that may occur before your computer boots to the operating system. It enables you to diagnose hardware issues, repair your computer, back up your files, or restore your computer to its factory state.

You can also download it from the Dell Support website to troubleshoot and fix your computer when it fails to boot into their primary operating system due to software or hardware failures.

For more information about the Dell SupportAssist OS Recovery, see *Dell SupportAssist OS Recovery User's Guide* at www.dell.com/serviceabilitytools. Click **SupportAssist** and then, click **SupportAssist OS Recovery**.

Backup media and recovery options

It is recommended to create a recovery drive to troubleshoot and fix problems that may occur with Windows. Dell proposes multiple options for recovering Windows operating system on your Dell PC. For more information, see [Dell Windows Backup Media and Recovery Options](#).

Wi-Fi power cycle

About this task

If your computer is unable to access the Internet due to Wi-Fi connectivity issues a Wi-Fi power cycle procedure may be performed. The following procedure provides the instructions on how to conduct a Wi-Fi power cycle:

 **NOTE:** Some ISPs (Internet Service Providers) provide a modem/router combo device.

Steps

1. Turn off your computer.
2. Turn off the modem.
3. Turn off the wireless router.
4. Wait for 30 seconds.
5. Turn on the wireless router.
6. Turn on the modem.
7. Turn on your computer.

Drain residual flea power (perform hard reset)

About this task

Flea power is the residual static electricity that remains in the computer even after it has been powered off and the battery is removed.

For your safety, and to protect the sensitive electronic components in your computer, you are requested to drain residual flea power before removing or replacing any components in your computer.

Draining residual flea power, also known as a performing a "hard reset", is also a common troubleshooting step if your computer does not power on or boot into the operating system.

To drain residual flea power (perform a hard reset)

Steps

1. Turn off your computer.
2. Disconnect the power adapter from your computer.
3. Remove the base cover.
4. Remove the battery.
5. Press and hold the power button for 20 seconds to drain the flea power.
6. Install the battery.
7. Install the base cover.
8. Connect the power adapter to your computer.
9. Turn on your computer.

 **NOTE:** For more information about performing a hard reset, search in the Knowledge Base Resource at www.dell.com/support.

Getting help and contacting Dell

Self-help resources

You can get information and help on Dell products and services using these self-help resources:

Table 23. Self-help resources

Self-help resources	Resource location
Information about Dell products and services	www.dell.com
Tips	
Contact Support	In Windows search, type <code>Contact Support</code> , and press Enter.
Online help for operating system	www.dell.com/support/windows www.dell.com/support/linux
Access top solutions, diagnostics, drivers and downloads, and learn more about your computer through videos, manuals and documents.	Your Dell computer is uniquely identified by a Service Tag or Express Service Code. To view relevant support resources for your Dell computer, enter the Service Tag or Express Service Code at www.dell.com/support . For more information on how to find the Service Tag for your computer, see Locate the Service Tag on your computer .
Dell knowledge base articles for a variety of computer concerns	<ol style="list-style-type: none"> 1. Go to www.dell.com/support. 2. On the menu bar at the top of the Support page, select Support > Knowledge Base. 3. In the Search field on the Knowledge Base page, type the keyword, topic, or model number, and then click or tap the search icon to view the related articles.

Contacting Dell

To contact Dell for sales, technical support, or customer service issues, see www.dell.com/contactdell.

 **NOTE:** Availability varies by country/region and product, and some services may not be available in your country/region.

 **NOTE:** If you do not have an active Internet connection, you can find contact information about your purchase invoice, packing slip, bill, or Dell product catalog.