

ASUS[®]

VA24EHF Series LCD Monitor

User Guide

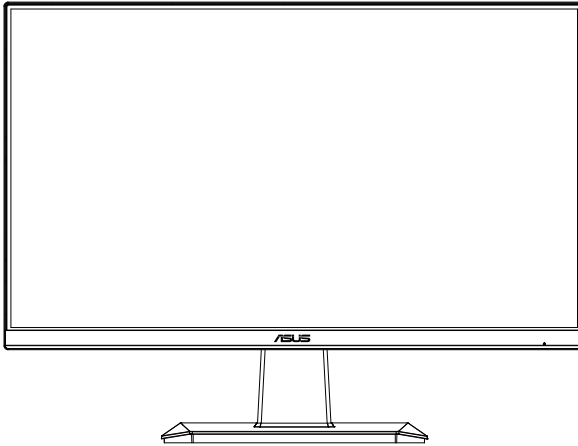

HDMI[™]
HIGH-DEFINITION MULTIMEDIA INTERFACE

Table of contents

TCO certified	iii
Notices	iv
Care & Cleaning	ix
Takeback Services	x
1.1 Welcome!	1-1
1.2 Package contents.....	1-1
1.3 Assembling the monitor	1-2
1.4 Connect cables.....	1-3
1.4.1 Rear of the LCD monitor	1-3
1.4.2 Six sides figure.....	1-4
1.5 Monitor introduction	1-5
1.5.1 Using the Controls button	1-5
2.1 Detaching the arm/stand (for VESA wall mount)	2-1
2.2 Adjusting the monitor	2-2
3.1 OSD (On-Screen Display) menu	3-1
3.1.1 How to reconfigure	3-1
3.1.2 OSD Function Introduction.....	3-2
3.2 Specifications.....	3-10
3.3 Troubleshooting (FAQ).....	3-12
3.4 Supported Timing List.....	3-13

Copyright © 2021 ASUSTeK COMPUTER INC. All Rights Reserved.

No part of this manual, including the products and software described in it, may be reproduced, transmitted, transcribed, stored in a retrieval system, or translated into any language in any form or by any means, except documentation kept by the purchaser for backup purposes, without the express written permission of ASUSTeK COMPUTER INC. ("ASUS").

Product warranty or service will not be extended if: (1) the product is repaired, modified or altered, unless such repair, modification or alteration is authorized in writing by ASUS; or (2) the serial number of the product is defaced or missing.

ASUS PROVIDES THIS MANUAL "AS IS" WITHOUT WARRANTY OF ANY KIND, EITHER EXPRESS OR IMPLIED, INCLUDING BUT NOT LIMITED TO THE IMPLIED WARRANTIES OR CONDITIONS OF MERCHANTABILITY OR FITNESS FOR A PARTICULAR PURPOSE. IN NO EVENT SHALL ASUS, ITS DIRECTORS, OFFICERS, EMPLOYEES OR AGENTS BE LIABLE FOR ANY INDIRECT, SPECIAL, INCIDENTAL, OR CONSEQUENTIAL DAMAGES (INCLUDING DAMAGES FOR LOSS OF PROFITS, LOSS OF BUSINESS, LOSS OF USE OR DATA, INTERRUPTION OF BUSINESS AND THE LIKE), EVEN IF ASUS HAS BEEN ADVISED OF THE POSSIBILITY OF SUCH DAMAGES ARISING FROM ANY DEFECT OR ERROR IN THIS MANUAL OR PRODUCT.

SPECIFICATIONS AND INFORMATION CONTAINED IN THIS MANUAL ARE FURNISHED FOR INFORMATIONAL USE ONLY, AND ARE SUBJECT TO CHANGE AT ANY TIME WITHOUT NOTICE, AND SHOULD NOT BE CONSTRUED AS A COMMITMENT BY ASUS. ASUS ASSUMES NO RESPONSIBILITY OR LIABILITY FOR ANY ERRORS OR INACCURACIES THAT MAY APPEAR IN THIS MANUAL, INCLUDING THE PRODUCTS AND SOFTWARE DESCRIBED IN IT.

Products and corporate names appearing in this manual may or may not be registered trademarks or copyrights of their respective companies, and are used only for identification or explanation and to the owners' benefit, without intent to infringe.

TCO certified

A third-party certification according to ISO 14024



Toward sustainable IT products



Say hello to a more sustainable product

IT products are associated with a wide range of sustainability risks throughout their life cycle. Human rights violations are common in the factories. Harmful substances are used both in products and their manufacture. Products can often have a short lifespan because of poor ergonomics, low quality and when they are not able to be repaired or upgraded.

This product is a better choice. It meets all the criteria in TCO Certified, the world's most comprehensive sustainability certification for IT products. Thank you for making a responsible product choice, that help drive progress towards a more sustainable future!

Criteria in TCO Certified have a life-cycle perspective and balance environmental and social responsibility. Conformity is verified by independent and approved verifiers that specialize in IT products, social responsibility or other sustainability issues. Verification is done both before and after the certificate is issued, covering the entire validity period. The process also includes ensuring that corrective actions are implemented in all cases of factory non-conformities. And last but not least, to make sure that the certification and independent verification is accurate, both TCO Certified and the verifiers are reviewed regularly.

Want to know more?

Read information about TCO Certified, full criteria documents, news and updates at [tcocertified.com](https://www.tcocertified.com). On the website you'll also find our Product Finder, which presents a complete, searchable listing of certified products.

Notices

Federal Communications Commission Statement

This device complies with Part 15 of the FCC Rules. Operation is subject to the following two conditions:

- This device may not cause harmful interference, and
- This device must accept any interference received including interference that may cause undesired operation.

This equipment has been tested and found to comply with the limits for a Class B digital device, pursuant to Part 15 of the FCC Rules. These limits are designed to provide reasonable protection against harmful interference in a residential installation. This equipment generates, uses and can radiate radio frequency energy and, if not installed and used in accordance with manufacturer's instructions, may cause harmful interference to radio communications. However, there is no guarantee that interference will not occur in a particular installation. If this equipment does cause harmful interference to radio or television reception, which can be determined by turning the equipment off and on, the user is encouraged to try to correct the interference by one or more of the following measures:

- Reorient or relocate the receiving antenna.
- Increase the separation between the equipment and receiver.
- Connect the equipment to an outlet on a circuit different from that to which the receiver is connected.
- Consult the dealer or an experienced radio/TV technician for help.



NOTE: This monitor is ENERGY STAR certified.

This product qualifies for ENERGY STAR in the factory default setting which can be restored by "Factory Reset" function in the OSD menu. Changing the factory default settings or enabling other features may increase power consumption that could exceed the ENERGY STAR specified limits.

Canadian Department of Communications Statement

This digital apparatus does not exceed the Class B limits for radio noise emissions from digital apparatus set out in the Radio Interference Regulations of the Canadian Department of Communications.

This class B digital apparatus complies with Canadian ICES-003.



Declaration of Conformity

This device complies with the requirements set out in the Council Directive on the Approximation of the Laws of the Member States relating to Electromagnetic Compatibility (2014/30/EU), Low-voltage Directive (2014/35/EU), ErP Directive (2009/125/EC) and RoHS directive (2011/65/EU). This product has been tested and found to comply with the harmonized standards for Information Technology Equipment, these harmonized standards published under Directives of Official Journal of the European Union.

WEEE Symbol Statement

This symbol on the product or on its packaging indicates that this product must not be disposed of with your other household waste. Instead, it is your responsibility to dispose of your waste equipment by handing it over to a designated collection point for the recycling of waste electrical and electronic equipment. The separate collection and recycling of your waste equipment at the time of disposal will help to conserve natural resources and ensure that it is recycled in a manner that protects human health and the environment. For more information about where you can drop off your waste equipment for recycling, please contact your local city office, your household waste disposal service or the shop where you purchased the product.



██████████
AEEE yönetmeliğine uygundur

Safety information

- Before setting up the monitor, carefully read all the documentation that came with the package.
- To prevent fire or shock hazard, never expose the monitor to rain or moisture.
- Never try to open the monitor cabinet. The dangerous high voltages inside the monitor may result in serious physical injury.
- If the power supply is broken, do not try to fix it by yourself. Contact a qualified service technician or your retailer.
- Before using the product, make sure all cables are correctly connected and the power cables are not damaged. If you detect any damage, contact your dealer immediately.
- Slots and openings on the back or top of the cabinet are provided for ventilation. Do not block these slots. Never place this product near or over a radiator or heat source unless proper ventilation is provided.
- The monitor should be operated only from the type of power source indicated on the label. If you are not sure of the type of power supply to your home, consult your dealer or local power company.
- Use the appropriate power plug which complies with your local power standard.
- Do not overload power strips and extension cords. Overloading can result in fire or electric shock.
- Avoid dust, humidity, and temperature extremes. Do not place the monitor in any area where it may become wet. Place the monitor on a stable surface.
- Unplug the unit during a lightning storm or if it will not be used for a long period of time. This will protect the monitor from damage due to power surges.
- Never push objects or spill liquid of any kind into the slots on the monitor cabinet.
- To ensure satisfactory operation, use the monitor only with UL listed computers which have appropriate configured receptacles marked between 100 ~ 240V AC.
- The socket-outlet shall be installed near the equipment and shall be easily accessible
- If you encounter technical problems with the monitor, contact a qualified service technician.
- Provide an earthing connection before the mains plug is connected to the mains. And, when disconnecting the earthing connection, be sure to disconnect after pulling out the mains plug from the mains.

WARNING

Usage of other than specified head- or earphones can result in hearing loss due to excessive sound pressures.

Please confirm the distribution system in building installation shall provide the circuit breaker rated 120/240V, 20A (maximum).

If provided with a 3-pin attachment plug on the power cord, plug the cord into a grounded (earthed) 3-pin outlet. Do not disable the power cord grounding pin, for example, by attaching a 2-pin adapter. The grounding pin is an important safety feature.

Stability Hazard.

The product may fall, causing serious personal injury or death. To prevent injury, this product must be securely attached to the floor/wall in accordance with the installation instructions.

A product may fall, causing serious personal injury or death. Many injuries, particularly to children, can be avoided by taking simple precautions such as:

ALWAYS use cabinets or stands or installation methods recommended by the manufacturer of the product set.

ALWAYS use furniture that can safely support the product.

ALWAYS ensure the product is not overhanging the edge of the supporting furniture.

ALWAYS educate children about the dangers of climbing on furniture to reach the product or its controls.

ALWAYS route cords and cables connected to your product so they cannot be tripped over, pulled or grabbed.

NEVER place a product in an unstable location.

NEVER place the product on tall furniture (for example, cupboards or bookcases) without anchoring both the furniture and the product to a suitable support.

NEVER place the product on cloth or other materials that may be located between the product and supporting furniture.

NEVER place items that might tempt children to climb, such as toys and remote controls, on the top of the product or furniture on which the product is placed.

If the existing product is going to be retained and relocated, the same considerations as above should be applied.

Excessive sound pressure from earphones and headphones can cause hearing loss. Adjustment of the equalizer to maximum increases the earphones and headphones output voltage and therefore the sound pressure level.

Restriction on Hazardous Substances statement (India) This product complies with the "India E-Waste (Management) Rules, 2016" and prohibits use of Lead, Mercury, Hexavalent Chromium, polybrominated biphenyls(PBBs) and polybrominated diphenyl ethers(PBDEs) in concentration exceeding 0.1% by weight in homogenous materials and 0.01% by weight in homogenous materials for cadmium, except of exemptions listed in Schedule 2 of the Rule.

Care & Cleaning

- Before you lift or reposition your monitor, it is better to disconnect the cables and power cord. Follow the correct lifting techniques when positioning the monitor. When lifting or carrying the monitor, grasp the edges of the monitor. Do not lift the display by the stand or the cord.
- Cleaning. Turn your monitor off and unplug the power cord. Clean the monitor surface with a lint-free, non-abrasive cloth. Stubborn stains may be removed with a cloth dampened with mild cleaner.
- Avoid using a cleaner containing alcohol or acetone. Use a cleaner intended for use with the LCD. Never spray cleaner directly on the screen, as it may drip inside the monitor and cause an electric shock.

The following symptoms are normal with the monitor:

- The screen may flicker during the initial use due to the nature of the fluorescent light. Turn off the Power Switch and turn it on again to make sure that the flicker disappears.
- You may find slightly uneven brightness on the screen depending on the desktop pattern you use.
- When the same image is displayed for hours, an afterimage of the previous screen may remain after switching the image. The screen will recover slowly or you can turn off the Power Switch for hours.
- When the screen becomes black or flashes, or cannot work anymore, contact your dealer or service center to fix it. Do not repair the screen by yourself!

Conventions used in this guide



WARNING: Information to prevent injury to yourself when trying to complete a task.



CAUTION: Information to prevent damage to the components when trying to complete a task.



IMPORTANT: Information that you **MUST** follow to complete a task.



NOTE: Tips and additional information to aid in completing a task.

Where to find more information

Refer to the following sources for additional information and for product and software updates.

1. **ASUS websites**

The ASUS websites worldwide provide updated information on ASUS hardware and software products. Refer to **<http://www.asus.com>**

2. **Optional documentation**

Your product package may include optional documentation that may have been added by your dealer. These documents are not part of the standard package.

Takeback Services

ASUS recycling and takeback programs come from our commitment to the highest standards for protecting our environment. We believe in providing solutions for our customers to be able to responsibly recycle our products, batteries and other components as well as the packaging materials.

Please go to <http://csr.asus.com/english/Takeback.htm> for detail recycling information in different region.

Product information for EU energy label



1.1 Welcome!

Thank you for purchasing the ASUS® LCD monitor!

The latest widescreen LCD monitor from ASUS provides a crisper, broader, and brighter display, plus a host of features that enhance your viewing experience.

With these features, you can enjoy the convenience and delightful visual experience that the monitor brings you!

1.2 Package contents

Check your package for the following items:

- ✓ LCD Monitor
- ✓ Monitor Base
- ✓ Monitor Column
- ✓ Quick Start Guide
- ✓ Warranty Card
- ✓ 1x Power Cord *
- ✓ 1x HDMI Cable *



-
- If any of the above items is damaged or missing, contact your retailer immediately.
 - * Also the Replaceable parts required by the TCO Certified.
-

1.3 Assembling the monitor

To assemble the monitor

1. Place the monitor face down on soft and smooth surface taking care to avoid scratching or damaging the screen. Attach/Slide the base column with the monitor until it clicks into position.
2. Buckling the base with stand, then hold them with both hands and firmly insert the stand into the cover. Adjust the monitor to the angle that is most comfortable for you.

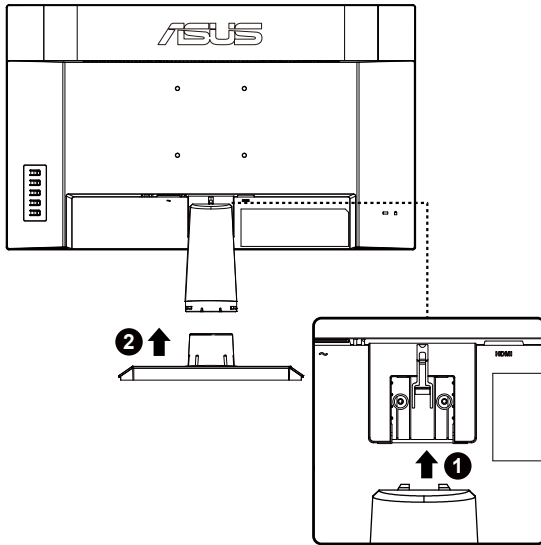

1.4 Connect cables

1.4.1 Rear of the LCD monitor

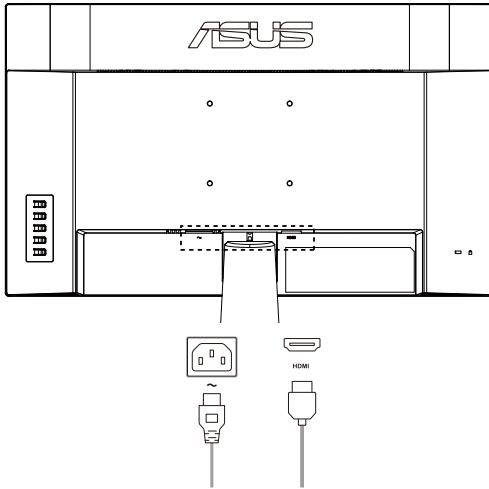

1. AC-IN Port
2. HDMI Port

1.4.2 Six sides figure

VA24EHF
UNIT:mm

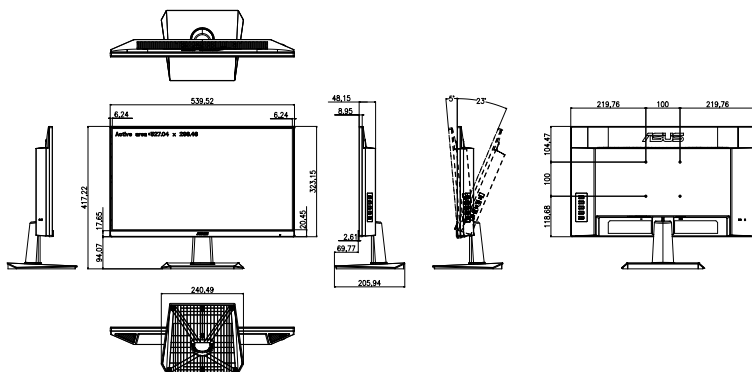

1.5 Monitor introduction

1.5.1 Using the Controls button

Use the control button on the back of the monitor to adjust the image settings.

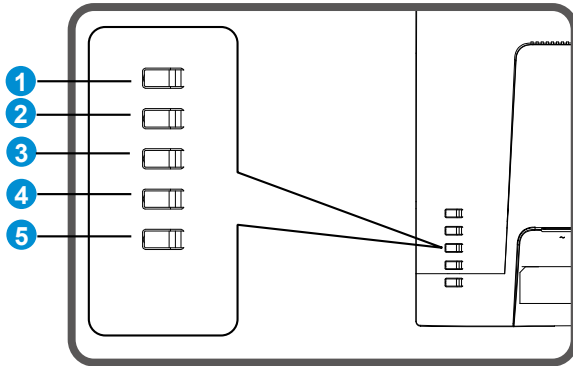

1. Menu Button/Exit OSD:
 - Press this Button enter the OSD menu.
 - Exit the OSD menu.
 - Return to previous menu.
 - Key Locked Hot key
2. Enter/Close/Return Button:
 - Exit the OSD menu.
 - Enter/select the icon (function) highlighted while the OSD is activated.
3. Brightness hot key/Decrease value:
 - Next Item or Decrease value
 - Brightness hot key
4. Energy Saving hot key/Increase value:
 - Add or Increase value
 - Energy Saving hot key
5. Power Button:
 - Power on/off monitor when monitor is power off/on.

2.1 Detaching the arm/stand (for VESA wall mount)

To detach the arm/stand

1. Disconnect power and signal cables, Carefully put the front of the monitor face down on a clean table.
2. Press down on the release button of the cover with one stand, while holding the stand with the other hand, and pull it horizontally backwards.



- We recommend that you cover the table surface with soft cloth to prevent damage to the monitor.

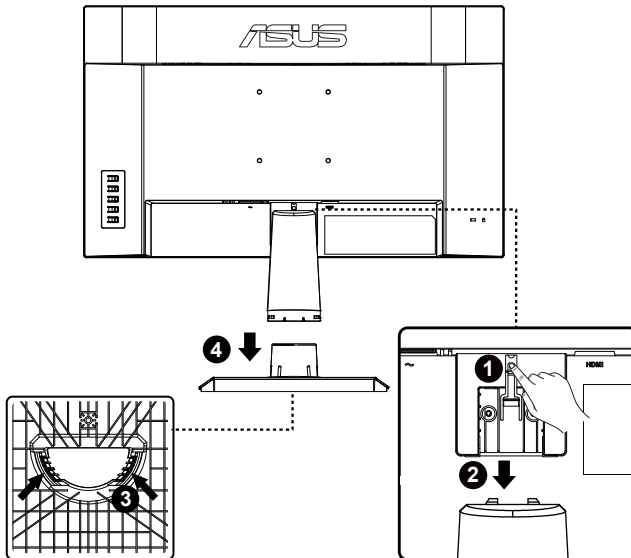

*Vesa mount: 100 x 100mm

*Base screw size: M4 x 8mm

2.2 Adjusting the monitor

- For optimal viewing, we recommend that you look at the full face of the monitor, then adjust the monitor to the angle that is most comfortable for you.
- Hold the stand to prevent the monitor from falling when you change its angle.
- Adjust the monitor follow the pictures for the most comfortable viewing for you.

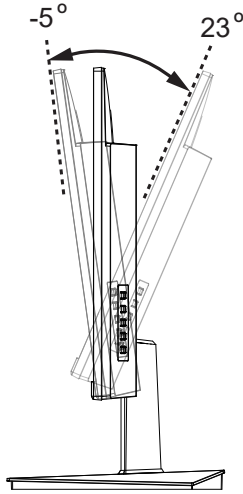

It is normal that the monitor slightly shakes while you adjust the viewing angle.

3.1 OSD (On-Screen Display) menu

3.1.1 How to reconfigure

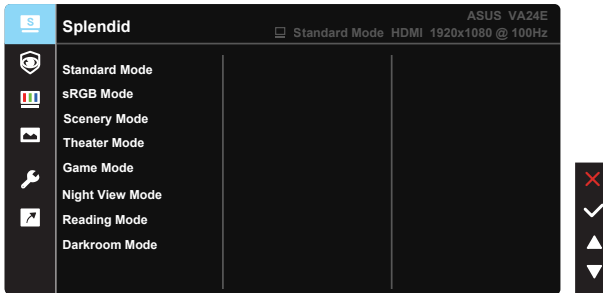

1. Press the MENU button to activate the OSD menu.
2. Press the ▼ and ▲ buttons to toggle between options in the Menu. As you move from one icon to another, the option name is highlighted.
3. To select the highlighted item on the menu press the ✓ key.
4. Press the ▼ and ▲ buttons to select the desired parameter.
5. Press the ✓ key to enter the slide bar and then use the ▼ or ▲ buttons, according to the indicators on the menu, to make your changes.

3.1.2 OSD Function Introduction

1. Splendid

This function contains eight sub-functions that you can select for your preference. Each mode has the Reset selection, allowing you to maintain your setting or return to the preset mode.

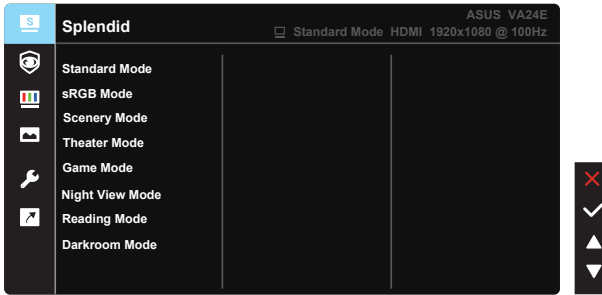

- **Standard Mode:** This is the best choice for document editing with SPLENDID™ Video Intelligence Technology.
- **sRGB Mode:** This is the best choice for viewing photos and graphics from PCs.
- **Scenery Mode:** This is the best choice for scenery photo displaying with SPLENDID™ Video Intelligence Technology.
- **Theater Mode:** This is the best choice for movie watching with SPLENDID™ Video Intelligence Technology.
- **Game Mode:** This is the best choice for game playing with SPLENDID™ Video Intelligence Technology.
- **Night View Mode:** This is the best choice for playing dark-scene game or watching dark-scene movie with SPLENDID™ Video Intelligence Technology.
- **Reading Mode :** This is the best choice for book reading.
- **Darkroom Mode :** This is the best choice for a weak ambient light environment.



-
- In the Standard Mode, the Saturation, Sharpness, and ASCR functions are not user-configurable.
 - In the sRGB, the Saturation, Color Temp., Sharpness, Brightness, Contrast and ASCR functions are not user-configurable.
 - In the Reading Mode, the Saturation, ASCR, contrast, and Color Temp functions are not user-configurable.
-

2. EyeCare

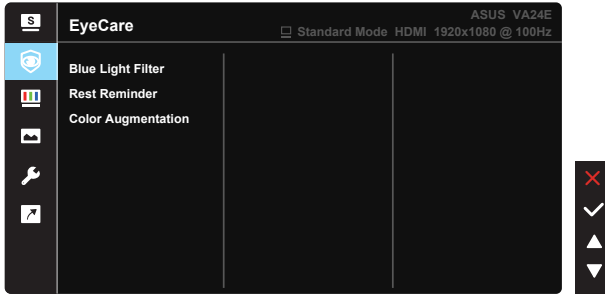

- **Blue Light Filter:** In this function, you can adjust the blue light filter from 0 to max. 0: no changes; Max: The higher the level, the less blue light is scattered. When blue light filter is activated, the default settings of Standard Mode will be automatically imported. Besides maximum level, the brightness is user-configurable. Maximum is the optimized setting. It is compliance with TUV low blue light certification*. The brightness function is not user configurable.



-
- When the user adjusts blue light filter bar to maximum level.
 - *When color augmentation is in default value (50).
-



Please refer to the following to alleviate eye strains:

- Users should take some time away from the display if working for long hours. It is advised to take short breaks (at least 5 mins) after around 1 hour of continuous working at the computer. Taking short and frequent breaks is more effective than a single longer break.
 - To minimize eye strain and dryness in your eyes, users should rest the eye periodically by focusing on objects that are far away.
 - Eye exercises can help to reduce eye strain. Repeat these exercises often. If eye strain continues please consult a physician. Eye exercises: (1) Repeating look up and down (2) Slowly roll your eyes (3) Move your eyes diagonal.
 - High energy blue light may lead to eye strain and AMD (Age-Related Macular Degeneration). Blue light filter to reduce 70% (max.) harmful blue light to avoiding CVS (Computer Vision Syndrome).
-

- **Rest Reminder:** This function provides you a rest reminder according to how long you set for your working time. For example, a user sets 60 minutes working time and there will be a pop up reminder appeared on the upper left corner of the monitor for 5 seconds. Press any key to make this reminder OSD disappeared.



-
- When this function is enable, the following functions are not available: Splendid Demo Mode, GamePlus and QuickFit.
-

- **Color Augmentation:** The adjusting range of color enhancement is from 0 to 100.



- This function is not available in sRGB mode under Splendid.

3. Color

Select the image color you like from this function.

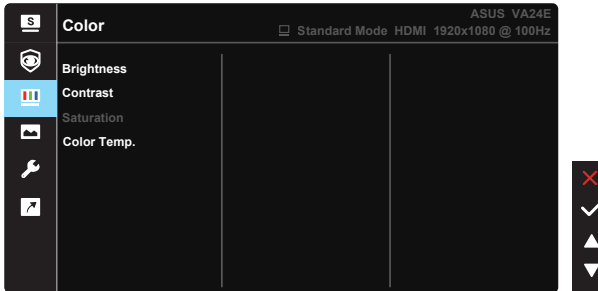

- **Brightness:** The adjusting range is from 0 to 100.
- **Contrast:** The adjusting range is from 0 to 100.
- **Saturation:** The adjusting range is from 0 to 100.
- **Color Temp.:** Contains three preset color modes (**Cool**, **Normal**, **Warm**) and **User Mode**.



- In the User Mode, colors of R (Red), G (Green), and B (Blue) are user-configurable; the adjusting range is from 0 ~ 100.

4. Image

You can adjust the image Sharpness, Trace Free, Aspect Control, VividPixel, ASCR, Adaptive-Sync from this main function.

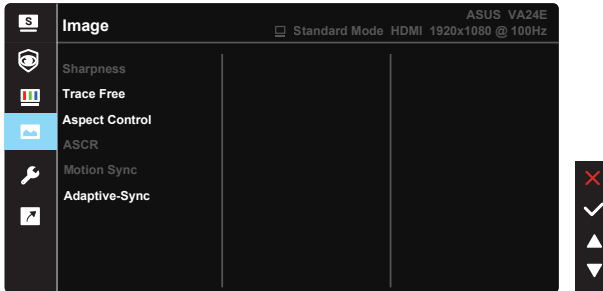

- **Sharpness:** Adjusts the picture sharpness. The adjusting range is from 0 to 100.
- **Trace Free:** Speeds up the response time by Over Drive technology. The adjusting range is from lower 0 to faster 100.
- **Aspect Control:** Adjusts the aspect ratio to “Full”, “1:1 Ratio” .
- **ASCR:** Select **ON** or **OFF** to enable or disable dynamic contrast ratio function.
- **Motion Sync:** Select Normal Mode, Advanced Mode or turn it off.
- **Adaptive-Sync:** It can allow a Adaptive-Sync supported graphics source to dynamically adjust display refresh rate based on typical content frame rates for power efficient, virtually stutter free and low-latency display update.

5. System Setup

Adjusts the system configuration.

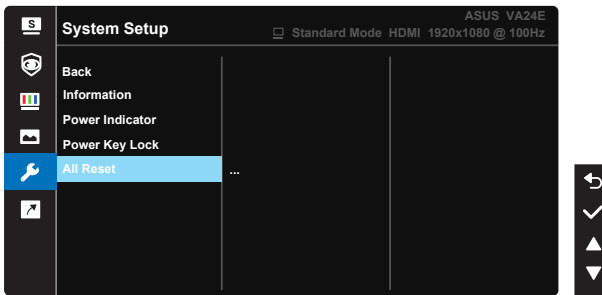
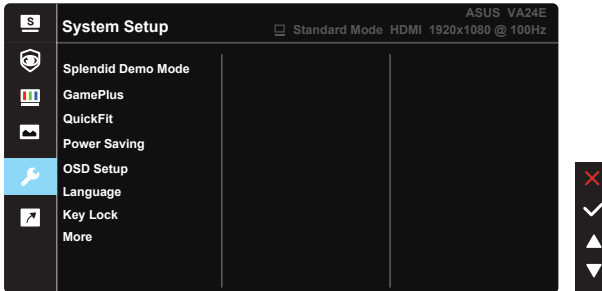

- **Splendid Demo Mode:** Activate the demo mode for the Splendid function.
- **GamePlus:** The GamePlus Function provides a toolkit and creates a better gaming environment for users when playing different types of games. Particularly, Aimpoint function is specially designed for new gamers or beginners interested in First Person Shooter (FPS) games.
To active GamePlus:
 - Select **ON** to enter the GamePlus main menu.
 - Press **▼** and **▲** to select between Crosshair, Timer, FPS Counter, Display Alignment function.
 - Press **✓** key to confirm the function you choose. Press **↶** to go back. Press **✗** to go off, and exit.



- **QuickFit:** contains three patterns: (1) Grid (2) Paper size (3) Photo size.
 1. Grid pattern: Facilitates designers and users to organize content and layout on one page and achieve a consistent look and feel.

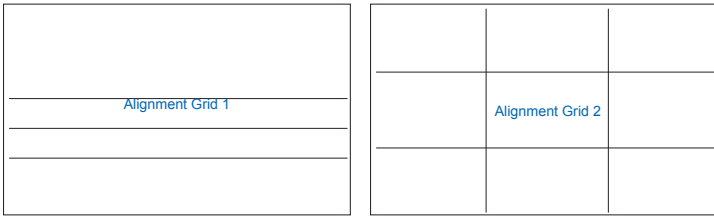

2. Paper size: Provides users to view their documents in real size on the screen.

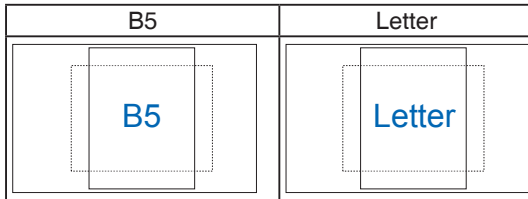

3. Photo size: Provides photographers and other users to accurately view and edit their photos in real size on the screen.

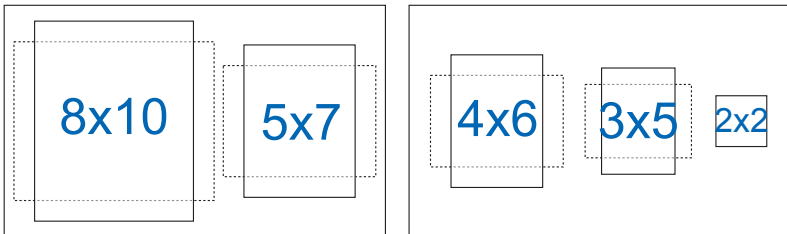

- **Power Saving:** Reduces power consumption. The default setting is “Deep Level”. When “Deep Level” is selected, the maximum brightness value is fixed and Splendid mode is fixed at “Standard Mode”.
- **OSD Setup:** Adjusts the **OSD Timeout**, **DDC/CI**, and **Transparency** of the OSD screen.
- **Language:** Select OSD language. The selections are: **English, French, German, Spanish, Italian, Dutch, Russian, Poland, Czech, Croacia, Hungary, Romania, Portugal, Turkey, Simplified Chinese, Traditional Chinese, Japanese, Korean, Persian, Thai, Indonesian, Ukrainian.**
- **Key Lock:** Disable all key functions. Pressing the Menu button on the back for more than five seconds to disable key lock function.
- **More:** Return the next page of System Setting.

- **Back:** Return the previous page of System Setting.
- **Information:** Displays the monitor information.
- **Power Indicator:** Turn the power LED indicator on/off.
- **Power Key Lock:** To disable / enable power key
- **All Reset:** Selects “Yes” to revert all settings to the factory default mode.

6. Shortcut

Selecting this option allows you to set two shortcut keys.

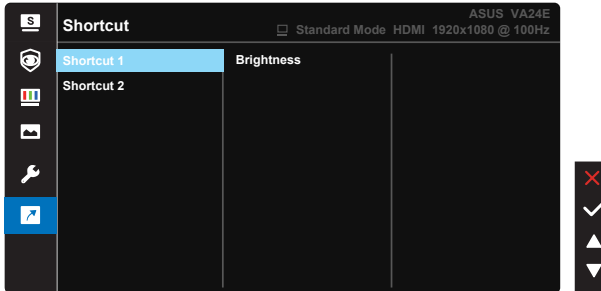

- **Shortcut 1:** User can select from “Blue Light Filter” “Splendid”, “Brightness”, “Contrast”, “Color Temp.”, “QuickFit”, “GamePlus”, “Rest Reminder”, “Color Augmentation”, “Energy Saving” and set as shortcut key. The default setting is Brightness .
- **Shortcut 2:** User can select from “Blue Light Filter” “Splendid”, “Brightness”, “Contrast”, “Color Temp.”, “QuickFit”, “GamePlus”, “Rest Reminder”, “Color Augmentation”, “Energy Saving” and set as shortcut key. The default setting is Energy Saving .

3.2 Specifications

Model	VA24EHF
Panel Type	TFT LCD
Panel Size	23.8"W
Max. Resolution	1920x1080
Pixel pitch	0.2745 mm x 0.2745 mm
Brightness (Typ.)	250cd/m ²
Contrast Ratio (Typ.)	1300:1
Contrast Ratio (Max.)	100,000,000:1 (with ASCR on)
Viewing Angle (CR>10)	178°(V) /178°(H)
Display Colors	16.7 M(6bit+FRC)
Response Time	1ms MPRT
Video Preset Mode (Splendid™)	8 modes (Scenery, Standard, Theater, Game, Night View, sRGB, Reading, Darkroom)
Color Temperature Selection	4 modes (Cool, Normal, Warm, User)
Signal Input	HDMI v1.4
AC input voltage	AC 100~240V(Built-in)
Power on consumption	12.02W(Based on Energy Star 8.0 standard)
Power saving mode	< 0.5W
Power off mode	< 0.3W under ERP Lot5
Colors	Black
Tilt	+23°~ -5°
Height Adjustment	NA
Kensington lock	Yes
VESA Wall Mounting	Yes (100mm x 100mm)
Temperature (Operating)	0°C~ 40°C
Operating Humidity	10% ~ 80%
Altitude	16,404 feet(5,000m)
Phys. Dimension with stand (WxHxD)	539.52mm x 417.22mm x 205.94mm

Phys. Dimension without stand (WxHxD) (For VESA Wall Mount)	539.52mm x 323.15mm x 48.15mm
Box Dimension (WxHxD)	600.00mm x 448.00 x 125.00mm
Net Weight (Esti.)	2.84 kg
Gross Weight (Esti.)	4.31 kg
Multi-languages	27 Languages (English, Simplified Chinese, Traditional Chinese, Japanese, Russian, Spanish, Italian, German, Franch, Dutch, Portuguese, Czech, Croatia, Romania, Turkish, Arabic, Danish, Finnish, Greek, Hungarian, Slovak, Slovenian, Swedish, Polish, Korean & Persian),Ukaraine.
Compliance and Standards	cTUVus, CB, CE, Erp, EU Energy label, FCC, ICES-003, CCC, CEL, ISO9241-307, BSMI, CU, RCM, MEPS, VCCI, PSE, J-MOSS, KC, KCC, e-Standby, RoHS, UkrSEPRO, PC Recycle, WHQL Windows 10/11(plus), Energy Star 8.0, TCO, TÜV Flicker-free, TÜV Low Blue Light, WEEE, CEC.

3.3 Troubleshooting (FAQ)

Problem	Possible Solution
Power LED is not ON	<ul style="list-style-type: none"> • Press the  button to check if the monitor is in the ON mode. • Check if the power cord is properly connected to the monitor and the power outlet. • Check Power Indicator function in main menu OSD. Select "ON" to turn on power LED.
The power LED lights amber and there is no screen image	<ul style="list-style-type: none"> • Check if the monitor and the computer are in the ON mode. • Make sure the signal cable is properly connected the monitor and the computer. • Inspect the signal cable and make sure none of the pins are bent. • Connect the computer with another available monitor to check if the computer is properly working.
Screen image is too light or dark	<ul style="list-style-type: none"> • Adjust the Contrast and Brightness settings via OSD.
Screen image bounces or a wave pattern is present in the image	<ul style="list-style-type: none"> • Make sure the signal cable is properly connected to the monitor and the computer. • Move electrical devices that may cause electrical interference.
Screen image has color defects (white does not look white)	<ul style="list-style-type: none"> • Inspect the signal cable and make sure that none of the pins are bent. • Perform Reset via OSD. • Adjust the R/G/B color settings or select the Color Temperature via OSD.

3.4 Supported Timing List

PC Supported Primary Timing

Resolution	Refresh Rate	Horizontal Frequency
640x480	60Hz	31.469kHz
640x480	72Hz	37.861kHz
640x480	75Hz	37.5kHz
800x600	56Hz	35.156kHz
800x600	60Hz	37.879kHz
800x600	72Hz	48.077kHz
800x600	75Hz	46.875kHz
1024x768	60Hz	48.363kHz
1024x768	70Hz	56.476kHz
1024x768	75Hz	60.023kHz
1152x864	75Hz	67.5kHz
1280x960	60Hz	60kHz
1280x1024	60Hz	63.981kHz
1280x1024	75Hz	79.976kHz
1440x900	60Hz	55.935kHz
1680x1050	60Hz	65.29kHz
1920x1080	60Hz	67.5kHz
1920x1080	75Hz	83.894kHz
1920x1080	100Hz	110.192kHz

MAC Modes, Factory Preset Timing

Resolution	Refresh Rate	Horizontal Frequency
640x480	67Hz	35kHz

VESA Modes, User Available Timing

Resolution	Refresh Rate	Horizontal Frequency
1280x720(RB)	60Hz	44.444kHz
1280x720	60Hz	44.772kHz
1680x1050(RB)	60Hz	64.674kHz
1920x1080	60Hz	66.587kHz

SD/HD Timings

HDMI1.4,CEA-861B Formats, SD/HD Supported Primary Timings of (HDMI input only)

Resolution	Refresh Rate	Horizontal Frequency
640 x 480 P	59.94/60Hz	31.469/31.5kHz
720 x 480 P	59.94/60Hz	31.469/31.5kHz
720 x 576 P	50Hz	31.25kHz
1280 x 720 P	50Hz	37.5kHz
1280 x 720 P	59.94/60Hz	44.955/45kHz

HDMI1.4,CEA-861B Formats, SD/HD Supported Optional Timings of (HDMI input only)

Resolution	Refresh Rate	Horizontal Frequency
1920x1080P	50Hz	56.25kHz
1920x1080P	59.94 / 60Hz	67.433 / 67.5kHz

* The modes not listed in the above tables may not be supported. For optimal resolution, we recommend that you choose a mode listed in the above tables.