

USER MANUAL

Pro Lite

LCD Monitor

ENGLISH

Pro Lite B1980D
Pro Lite E1980D

Thank you very much for choosing the iiyama LCD monitor.

We recommend that you take a few minutes to read carefully through this brief but comprehensive manual before installing and switching on the monitor. Please keep this manual in a safe place for your future reference.



Dear user, we congratulate you on the purchase of your iiyama LCD.

For details on warranty and locally used pixel policies that apply directly after installation of your product please check the iiyama website.

To report a fault, please contact your local support centre found at www.iiyama.com/service

Things to check before you call the iiyama information line

- | if the power cable is connected securely and turned on?
- | if the display has been turned on?
- | if the signal cable is connected securely and the correct input selected?
- | if the computer has been restarted with the display connected?
- | if the graphics card is correctly installed with the latest drivers possible?
- | if the correct native resolution has been selected via 'Display Properties'?
- | If the R/G/B signal configuration is correct?
- | if the displays On Screen Menu is shown?
- | if the correct brightness and contrast settings have been set?
- | if given display tolerances and compatibility have been considered?
- | if via the On Screen Menu you have performed a Factory Reset/Recall?

Before reporting the screen defect, please prepare the following information/evidence:

- | model number *
- | purchase receipt and serial number *
- | name and address for collection
- | telephone/fax number, for availability during the day
- | convenient collection date (date, time)
- | short description of the defect

Important Note:

If there is no fault found in the collected equipment after inspection, the transferring party shall incur charges for transport and administration.

If you have checked all of the above and there is still no picture, call our information line for assistance in your country.

* see the identification plate on the back of the case.

CE MARKING DECLARATION OF CONFORMITY

This LCD monitor complies with the requirements of the EC/EU Directive 2014/30/EU "EMC Directive", 2014/35/EU "Low Voltage Directive", 2009/125/EC "ErP Directive" and 2011/65/EU "RoHS Directive".

The electro-magnetic susceptibility has been chosen at a level that gives correct operation in residential areas, business and light industrial premises and small-scale enterprises, inside as well as outside of the buildings. All places of operation are characterised by their connection to the public low voltage power supply system.

IYAMA CORPORATION: Wijkmeerstraat 8, 2131 HA Hoofddorp, The Netherlands

Model No. : PL1980



We recommend recycling of used product. Please contact your dealer or iiyama service center. Recycle information is obtained via the Internet, using the address: <http://www.iiyama.com>

You can access the Web page of different countries from there.

- We reserve the right to change specifications without notice.
- All trademarks used in this user manual are the property of their respective owners.
- As an ENERGY STAR® Partner, iiyama has determined that this product meets the ENERGY STAR® guidelines for energy efficiency.
- This product qualifies for ENERGY STAR® in the "factory default" setting and this is the setting in which power saving will be achieved. Changing the factory default picture settings or enabling other features will increase power consumption that could exceed the limits necessary to qualify for ENERGY STAR® rating.
- Eprel registration number B1980D-B5 : 1335868 , B1980D-W5 : 1335920, E1980D-B1 : 819356

TABLE OF CONTENTS

| | |
|---|----|
| FOR YOUR SAFETY..... | 1 |
| SAFETY PRECAUTIONS..... | 1 |
| SPECIAL NOTES ON LCD MONITORS..... | 3 |
| CUSTOMER SERVICE..... | 3 |
| CLEANING..... | 3 |
| BEFORE YOU OPERATE THE MONITOR..... | 4 |
| FEATURES..... | 4 |
| CHECKING THE CONTENTS OF THE PACKAGE..... | 4 |
| INSTALLATION..... | 5 |
| FITTING AND REMOVAL OF BASE : ProLite B1980D..... | 7 |
| FITTING AND REMOVAL OF BASE : ProLite E1980D..... | 8 |
| CONTROLS AND CONNECTORS : ProLite B1980D..... | 9 |
| CONTROLS AND CONNECTORS : ProLite E1980D..... | 10 |
| CONNECTING YOUR MONITOR : ProLite B1980D..... | 11 |
| CONNECTING YOUR MONITOR : ProLite E1980D..... | 12 |
| COMPUTER SETTING..... | 13 |
| ADJUSTING THE HEIGHT AND THE VIEWING ANGLE : | |
| ProLite B1980D..... | 13 |
| ADJUSTING THE VIEWING ANGLE : ProLite E1980D..... | 14 |
| OPERATING THE MONITOR..... | 15 |
| ADJUSTMENT MENU CONTENTS..... | 16 |
| SCREEN ADJUSTMENTS..... | 22 |
| STANDBY FEATURE..... | 25 |
| TROUBLE SHOOTING..... | 26 |
| RECYCLING INFORMATION..... | 27 |
| APPENDIX..... | 28 |
| SPECIFICATIONS : ProLite B1980D-B5 / ProLite B1980D-W5..... | 28 |
| SPECIFICATIONS : ProLite E1980D-B1..... | 29 |
| DIMENSIONS : ProLite B1980D-B5 / ProLite B1980D-W5..... | 30 |
| DIMENSIONS : ProLite E1980D-B1..... | 30 |
| COMPLIANT TIMING..... | 31 |

FOR YOUR SAFETY

SAFETY PRECAUTIONS

WARNING

STOP OPERATING THE MONITOR IF YOU ARE AWARE OF ANY PROBLEMS

If you notice any abnormal phenomena such as smoke, strange sounds or fumes, unplug the monitor and contact your dealer or iiyama service center immediately. Further use may be dangerous and can cause fire or electric shock.

NEVER REMOVE THE CABINET

High voltage circuits are inside the monitor. Removing the cabinet may expose you to the danger of fire or electric shock.

DO NOT PUT ANY OBJECT INTO THE MONITOR

Do not put any solid objects or liquids such as water into the monitor. In case of an accident, unplug your monitor immediately and contact your dealer or iiyama service center. Using the monitor with any object inside may cause fire, electric shock or damage.

INSTALL THE MONITOR ON A FLAT, STABLE SURFACE

The monitor may cause an injury if it falls or is dropped.

DO NOT USE THE MONITOR NEAR WATER

Do not use where water may be splashed or spilt onto the monitor as it may cause fire or electric shock.

OPERATE UNDER THE SPECIFIED POWER SUPPLY

Be sure to operate the monitor only with the specified power supply. Use of an incorrect voltage will cause malfunction and may cause fire or electric shock.

PROTECT THE CABLES

Do not pull or bend the power cable and signal cable. Do not place the monitor or any other heavy objects on the cables. If damaged, the cables may cause fire or electric shock.

ADVERSE WEATHER CONDITIONS

It is advisable not to operate the monitor during a heavy thunder storm as the continual breaks in power may cause malfunction. It is also advised not to touch the plug in these circumstances as it may cause electric shock.

CAUTION

INSTALLATION LOCATION

Do not install the monitor where sudden temperature changes may occur, or in humid, dusty or smoky areas as it may cause fire, electric shock or damage. You should also avoid areas where the sun shines directly on the monitor.

DO NOT PLACE THE MONITOR IN A HAZARDOUS POSITION

The monitor may topple and cause injury if not suitably located. Please also ensure that you do not place any heavy objects on the monitor, and that all cables are routed such that children may not pull the cables and possibly cause injury.

MAINTAIN GOOD VENTILATION

Ventilation slots are provided to keep the monitor from overheating. Covering the slots may cause fire. To allow adequate air circulation, place the monitor at least 10 cm (or 4 inches) from any walls. When removing the tilt stand, the ventilation slots on the back side of the monitor can be blocked. This may overheat the monitor and may cause fire or damage. Make sure to allow enough ventilation when removing the tilt stand. Operating the monitor on its back, side, upside down or on a carpet or any other soft material may also cause damage.

DISCONNECT THE CABLES WHEN YOU MOVE THE MONITOR

When you move the monitor, turn off the power switch, unplug the monitor and be sure the signal cable is disconnected. If you do not disconnect them, it may cause fire or electric shock.

UNPLUG THE MONITOR

If the monitor is not in use for a long period of time it is recommended that it is left unplugged to avoid accidents.

HOLD THE PLUG WHEN DISCONNECTING

To disconnect the power cable or signal cable, always pull it by the plug. Never pull on the cable itself as this may cause fire or electric shock.

DO NOT TOUCH THE PLUG WITH WET HANDS

Pulling or inserting the plug with wet hands may cause electric shock.

WHEN YOU INSTALL THE MONITOR ON YOUR COMPUTER

Be sure the computer is strong enough to hold the weight of the monitor, otherwise, you may damage your computer.

CAREFUL! PROTECT YOUR HANDS AND FINGERS

- Be careful not to hurt your fingers or hands when you change the height or the angle.
- Injury can occur if care is not taken to avoid finger contact with the displays base when adjusting the height. (Just for height adjustable model.)

REMARK FOR 24/7 USAGE

This product is not specifically designed for 24/7 usage in all environments.

OTHERS

ERGONOMIC RECOMMENDATIONS

To eliminate eye fatigue, do not operate the monitor against a bright background or in a dark room. For optimal viewing comfort, the monitor should be just below eye level and 40-60 cm (16-24 inches) away from your eyes. When using the monitor over a prolonged time, a ten minute break every hour is recommended as looking at the screen continuously can cause eye strain.

SPECIAL NOTES ON LCD MONITORS

The following symptoms are normal with LCD monitors and do not indicate a problem.

- NOTE**
- When you first turn on the LCD monitor, the picture may not fit in the display area because of the type of computer that is used. In this case, adjust the picture position to the correct position.
 - You may find slightly uneven brightness on the screen depending on the desktop pattern you use.
 - Due to the nature of the LCD screen, an afterimage of the previous screen may remain after switching the image, when the same image is displayed for hours. In this case, the screen can be recovered slowly by changing the image or turning off the Power Switch for some hours.

CUSTOMER SERVICE

- NOTE**
- If you have to return your unit for service and the original packaging has been discarded, please contact your dealer or iiyama service center for advice or replacement packaging.

CLEANING

- WARNING**
- If you drop any materials or liquids such as water into the monitor when cleaning, unplug the power cable immediately and contact your dealer or iiyama service center.

- CAUTION**
- For safety reasons, turn off the power switch and unplug the monitor before you clean it.

- NOTE**
- To protect the LCD panel, do not scratch or rub the screen with a hard object.
 - Never use any of the following strong solvents. These will damage the cabinet and the LCD screen.

| | |
|------------------|--------------------------|
| Thinner | Spray-type cleaner |
| Benzene | Wax |
| Abrasive cleaner | Acid or Alkaline solvent |

- Touching the cabinet with any product made from rubber or plastic for a long time may cause degeneration or loss of paint on the cabinet.

CABINET Stains can be removed with a cloth lightly moistened with a mild detergent solvent. Then wipe the cabinet with a soft dry cloth.

LCD Periodic cleaning with a soft dry cloth is recommended.

SCREEN Don't use tissue paper etc. because these will damage the LCD screen.

BEFORE YOU OPERATE THE MONITOR

FEATURES

- ◆ Supports Resolutions up to 1280 × 1024
- ◆ High Contrast 1000:1 (Typical), Adv. Contrast Function Available / Brightness 250cd/m² (Typical) / Quick Response Time 5ms (Typical)
- ◆ Digital Character Smoothing
- ◆ Automatic Set-up
- ◆ Standby Feature (ENERGY STAR® and VESA DPMS Compliant)
- ◆ VESA Mounting Standard (100mm×100mm) Compliant
- ◆ Keyhole for Security Lock

CHECKING THE CONTENTS OF THE PACKAGE

The following accessories are included in your package. Check to see if they are enclosed with the monitor. If anything is missing or damaged, please contact your local iiyama dealer or regional iiyama office.

- | | | |
|-----------------------------|----------------|---|
| ■ Power Cable* ¹ | ■ DVI-D Cable | ■ Stand-Base with a screw* ² |
| ■ Stand-Base* ³ | ■ Stand-Neck | ■ Cable Holder* ³ |
| ■ Screwdriver* ² | ■ Safety Guide | ■ Quick Start Guide |

CAUTION

*¹ The rating of the Power Cable enclosed in 120V area is 10A/125V. If you are using a power supply higher than this rating, then a power cable with a rating of 10A/250V must be used. However, all guarantees and warranties are void for any problems or damage caused by a power cable not supplied by iiyama.
An approved power cable greater or equal to H05VVVF, 3G, 0.75mm² must be used.

*² Accessory for ProLite B1980D.

*³ Accessory for ProLite E1980D.

INSTALLATION

CAUTION

- Before installation, make sure the wall, ceiling or desktop arm is strong enough to hold the necessary weight of the display and the mount.

[WALL MOUNTING]

CAUTION

- When you use with the wall mounting, in consideration of thickness of the mounting stage, tighten the M4 Screws (4 pcs) which "L" length is 7mm to fasten the monitor. Using the screw longer than this may cause electric shock or damage because it may contact with the electrical parts inside the monitor.

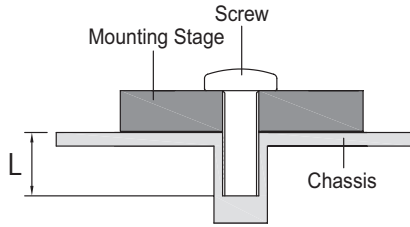

[ROTATING THE MONITOR]

• ProLite B1980D

The monitor is designed to be compatible with both landscape and portrait (clockwise) modes. Video card for portrait display will be required for rotating the image on the screen.

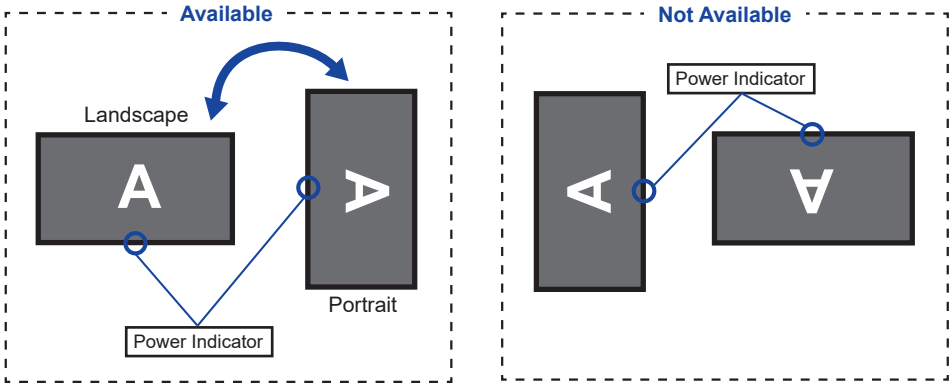

With Stand:

NOTE

- Adjust the monitor's height before panel rotation.
- Attempting to rotate the panel forcibly without adjusting the stand height may cause damage to the panel or the stand.

• ProLite E1980D

The monitor is designed to be compatible only with the landscape mode.

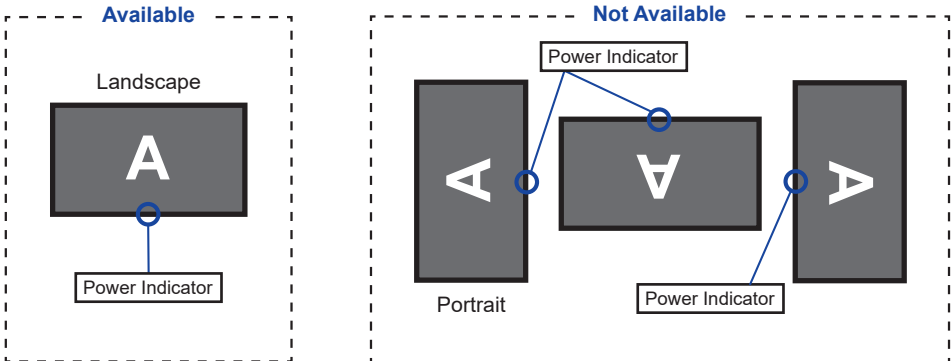

FITTING AND REMOVAL OF BASE : ProLite B1980D

CAUTION

- Put the monitor on a stable surface. The monitor may cause injury or damage if it falls or is dropped.
- Do not give a strong impact to the monitor. It may cause damage.
- Unplug the monitor before removal or installation to avoid an electric shock or a damage.

<Installation>

- ① Put a piece of soft cloth on the table beforehand to prevent the monitor from being scratched. Lay the monitor flat on a table with front face down.
- ② Install the Stand-Neck to the monitor and then tighten the 'thumb screw' with the provided screwdriver to secure them.

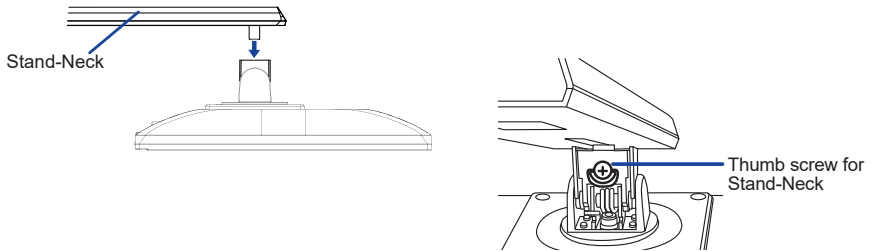

- ③ Install the Stand-Base to the Stand-Neck and then tighten the 'thumb screw' to secure them.

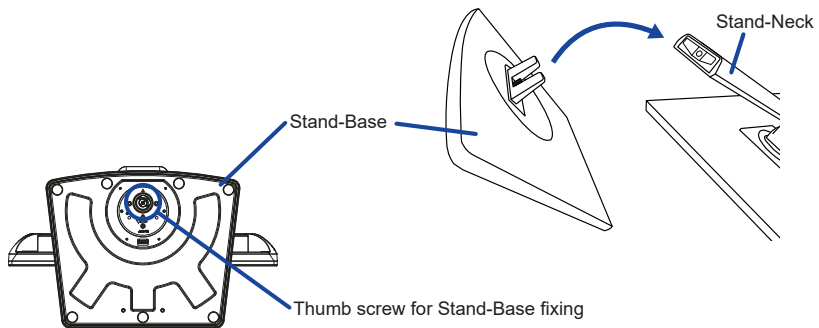

<Removal>

- ① Put a piece of soft cloth on the table beforehand to prevent the monitor from being scratched. Lay the monitor flat on a table with front face down.
- ② Loosen the 'thumb screw' to remove the Stand-Base from the monitor.
- ③ Loosen the 'thumb screw' with the provided screwdriver to remove the Stand-Neck from the monitor.

FITTING AND REMOVAL OF BASE : ProLite E1980D

CAUTION

- Put the monitor on a stable surface. The monitor may cause injury or damage if it falls or is dropped.
- Do not give a strong impact to the monitor. It may cause damage.
- Unplug the monitor before removal or installation to avoid an electric shock or a damage.

<Installation>

- ① Put a piece of soft cloth on the table beforehand to prevent the monitor from being scratched. Lay the monitor flat on a table with front face down.
- ② Hold the monitor and install the Stand-Neck to the monitor until it clicks to secure.
- ③ Install the Stand-Base to the Stand-Neck.
- ④ Place the Cable Holder.

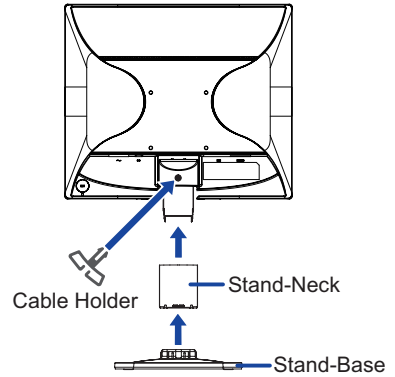

<Removal>

- ① Put a piece of soft cloth on the table beforehand to prevent the monitor from being scratched. Lay the monitor flat on a table with front face down.
- ② Keep pressing the Hooks inward to pull out the Stand-Neck.
- ③ There are two locks inside of the Stand-Neck, unlock them by thin stick and pull the Stand-Neck away from the monitor.

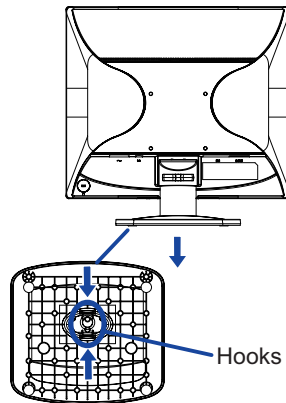
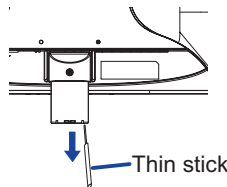

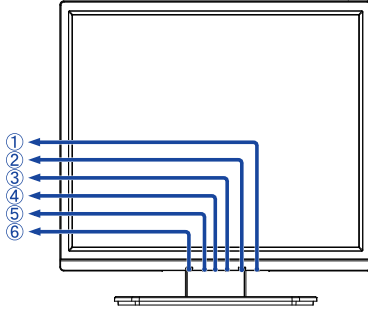

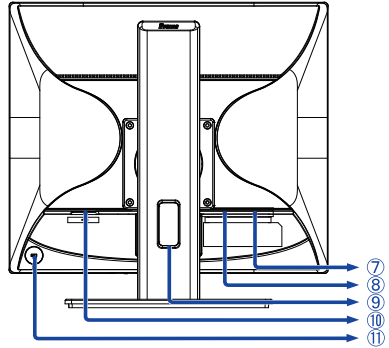

<Front>



<Back>

- ① Power Switch ()
- ② Menu Button (MENU)
- ③ + Button (+ / )
- ④ Power Indicator
- ⑤ - Button (- / )
- ⑥ Auto Adjust / Signal Select Button (AUTO) *
- ⑦ VGA Connector (D-SUB)
- ⑧ DVI-D Connector (DVI)
- ⑨ Cable Hole
- ⑩ AC Connector (~ : Alternating current)
- ⑪ Keyhole for Security Lock

NOTE Blue: Normal operation
Orange: Standby Mode

NOTE You can fasten a security lock and cable to prevent the monitor from being removed without your permission.

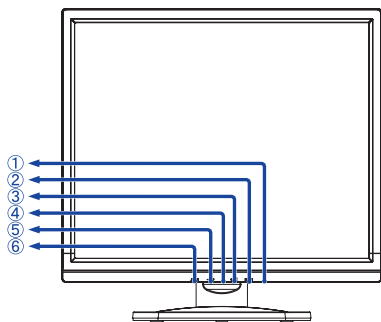

* You can skip the Menu items and directly display an option setting screen or an adjustment scale.

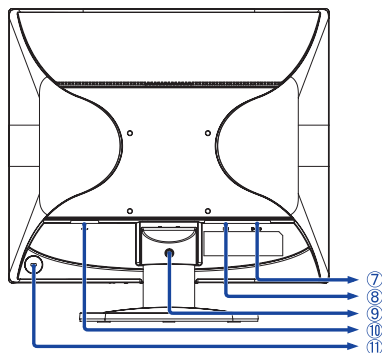

<Front>



<Back>

- ① Power Switch ()
- ② Menu Button (MENU)
- ③ + Button (+ / )
- ④ Power Indicator
- ⑤ - Button (- / )
- ⑥ Auto Adjust / Signal Select Button (AUTO) *

NOTE Blue: Normal operation
Orange: Standby Mode

- ⑦ VGA Connector (D-SUB)
- ⑧ DVI-D Connector (DVI)
- ⑨ Installation hole of Cable Holder
- ⑩ AC Connector (~ : Alternating current)
- ⑪ Keyhole for Security Lock

NOTE You can fasten a security lock and cable to prevent the monitor from being removed without your permission.

* You can skip the Menu items and directly display an option setting screen or an adjustment scale.

CONNECTING YOUR MONITOR : ProLite B1980D

- ① Ensure that both the computer and the monitor are switched off.
- ② Connect the computer to the monitor with the signal cable.
- ③ Connect the Power Cable to the monitor first and then to the power source.
- ④ Turn on your monitor and computer.

NOTE

- Make sure that the building installation has a circuit breaker of 120/240V, 20A (maximum).
- The signal cables used for connecting the computer and monitor may vary with the type of computer used. An incorrect connection may cause serious damage to both the monitor and the computer. The cable supplied with the monitor is for a standard connector. If a special cable is required please contact your local iiyama dealer or regional iiyama office.
- Make sure you tighten the finger screws at each end of the signal cable.
- The Class I pluggable equipment Type A must be connected to protective earth.
- The socket-outlet shall be installed near the equipment and shall be easily accessible.

[Example of Connection]

<Back>

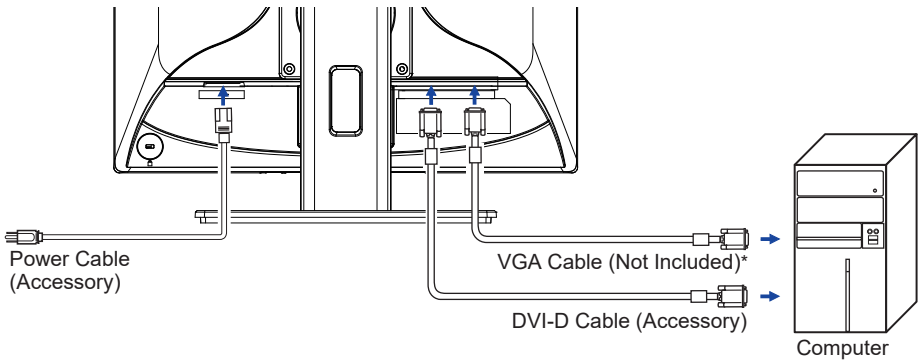

* VGA cable is not supplied with the monitor. If you use low quality VGA cable, it may cause a result of electro-magnetic interference. Please contact the iiyama Support Centre in your country if you wish to connect the monitor via the VGA input.

[Collect Cables]

Put the cables through the Cable Hole to bundle them.

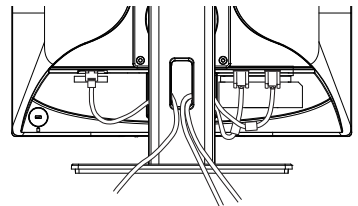

CONNECTING YOUR MONITOR : ProLite E1980D

- ① Ensure that both the computer and the monitor are switched off.
- ② Connect the computer to the monitor with the signal cable.
- ③ Connect the Power Cable to the monitor first and then to the power source.
- ④ Turn on your monitor and computer.

NOTE

- Make sure that the building installation has a circuit breaker of 120/240V, 20A (maximum).
- The signal cables used for connecting the computer and monitor may vary with the type of computer used. An incorrect connection may cause serious damage to both the monitor and the computer. The cable supplied with the monitor is for a standard connector. If a special cable is required please contact your local iiyama dealer or regional iiyama office.
- Make sure you tighten the finger screws at each end of the signal cable.
- The Class I pluggable equipment Type A must be connected to protective earth.
- The socket-outlet shall be installed near the equipment and shall be easily accessible.

[Example of Connection]

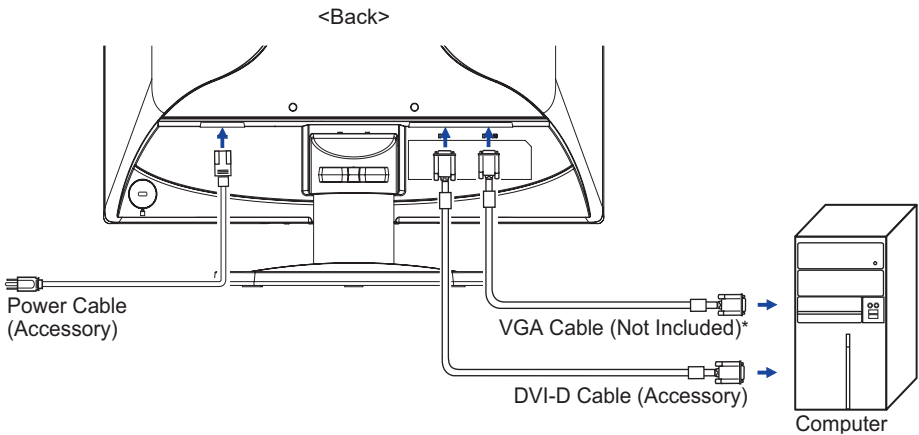

* VGA cable is not supplied with the monitor. If you use low quality VGA cable, it may cause a result of electro-magnetic interference. Please contact the iiyama Support Centre in your country if you wish to connect the monitor via the VGA input.

[Collect Cables]

Put the cables through the Cable Holder to bundle them.

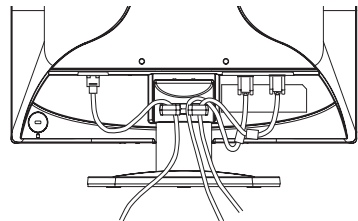

COMPUTER SETTING

■ Signal Timing

Change to the desired signal timing listed on page 31: COMPLIANT TIMING.

ADJUSTING THE HEIGHT AND THE VIEWING ANGLE : ProLite B1980D

- For optimal viewing it is recommended to position yourself directly opposite to the full face of the monitor, then adjust the monitor's height and angle to your own preference.
- Hold the panel so that the monitor does not topple when you change the monitor's height or angle.
- You are able to adjust the monitor's height up to 150mm, angle up to 45° right and left, 23° upward and 5° downward.

NOTE

- Do not touch the LCD screen when you change the height or the angle. It may cause damage or break the LCD screen.
- Careful attention is required not to pinch your fingers or hands into the moving part of the stand when you change the height or the angle.
- Injury can occur if care is not taken to avoid finger contact with the displays base when adjusting the height.

5° 23°

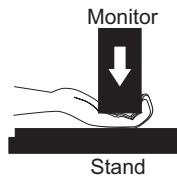
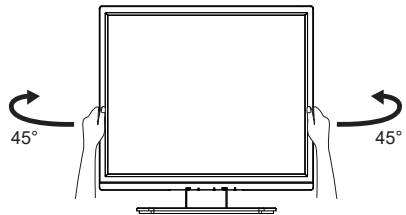
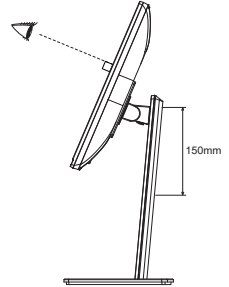

ADJUSTING THE VIEWING ANGLE : ProLite E1980D

- For optimal viewing it is recommended to look at the full face of the monitor.
- Hold the stand so that the monitor does not topple when you change the monitor's angle.
- You are able to adjust the monitor's angle up to 21° upward, 4° downward.
- In order to ensure a healthy and relaxed body position when using the monitor at visual display workstations, it is recommended that the adjusted tilt angle should not exceed 10°. Adjust the monitor's angle to your own preference.

- NOTE**
- Do not touch the LCD screen when you change the angle. It may cause damage or break the LCD screen.
 - Careful attention is required not to pinch your fingers or hands into the moving part of the stand when you change the angle.

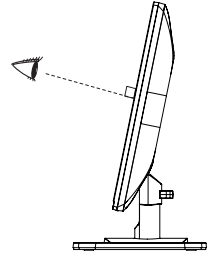
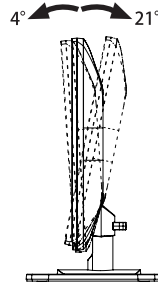

OPERATING THE MONITOR

To create the best picture, your iiyama LCD monitor has been preset at the factory with the COMPLIANT TIMING shown on page 31. You are also able to adjust the picture by following the button operation shown below. For more detailed adjustments, see page 22 for SCREEN ADJUSTMENTS.

- ① Press the MENU Button to start the On Screen Display feature. There are additional Menu items which can be switched by using the + / - Buttons.

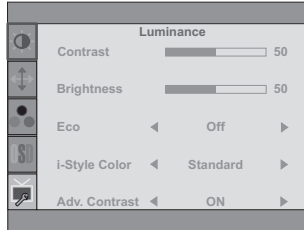

- ② Select the Menu item which contains the adjustment icon relating to the adjustment you want to make. Press the MENU Button. Then, use the + / - Buttons to highlight the desired adjustment icon.
- ③ Press the MENU Button again. Use the + / - Buttons to make the appropriate adjustment or setting.
- ④ Press the AUTO Button to leave the menu, and the settings you just made would be automatically saved.

For example, to correct for vertical position, select Menu item of Image Setup and then press the MENU Button. Then, select V.Position by using the + / - Buttons.

An adjustment page appears after you press the MENU Button. Then, use the + / - Buttons to change the vertical position settings. The vertical position of the overall display should be changing accordingly while you are doing this.

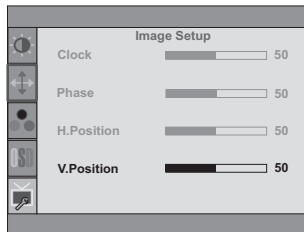

Press the AUTO Button lastly, it ends, all changes are saved in the memory.

NOTE

- When button operations are aborted during adjustment, On-Screen Display disappears when the time set for the Timeout has passed. Also, the AUTO Button can be used to return previous menu and turn off the On-Screen Display.
- Any changes are automatically saved in the memory when the On Screen Display disappears. Turning off the power should be avoided while using the Menu.
- Adjustments for H. / V. Position, Clock and Phase are saved for each signal timing. Except for these adjustments, all other adjustments have only one setting which applies to all signal timings.

ADJUSTMENT MENU CONTENTS

| Adjustment Item | | Problem / Option | Button to Press |
|--|---------------|------------------|--|
| Contrast | | Too dull | + |
| | | Too intense | - |
| Brightness * | | Too dark | + |
| | | Too bright | - |
| Eco | Direct | Off | Normal |
| | | Mode1 | Brightness of back-light is reduced. |
| | | Mode2 | Brightness of back-light is reduced more than Mode1. |
| | | Mode3 | Brightness of back-light is reduced more than Mode2. |
| i-Style Color | | Standard | For general windows environment and monitor default setting. |
| | | Text | For text editing and viewing in a word processing environment. |
| | | Internet | For internet environment. |
| | | Game | For PC game environment. |
| | | Movie | For movie and video environment. |
| | | Sports | For sport environment. |
| Adv. Contrast | | On | Increased Contrast Ratio |
| | | Off | Typical Contrast Ratio |
| <p>NOTE Adv. Contrast adjusts brightness according to the image, and improve the contrast ratio during movie playing. Contrast, Brightness, sRGB, Eco and i-Style Color cannot be adjusted and selected while Adv. Contrast is active.</p> | | | |

* Adjust the Brightness when you are using the monitor in a dark room and feel the screen is too bright.









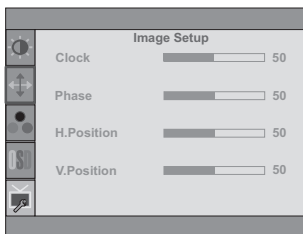













Direct

You can skip the Menu items and directly display an option setting screen by using the following button operations.

- Eco: Press the - Button when the Menu is not displayed.

Image Setup





| Adjustment Item | Problem / Option | Button to Press |
|---------------------------|--|--|
| Clock* ^{1,2} |  Too narrow  Too wide |     |
| Phase* ^{1,2} | To correct flickering text or lines |     |
| H. Position* ² |  Too left  Too right |     |
| V. Position* ² |  Too low  Too high |     |

*¹ See page 22 for SCREEN ADJUSTMENTS.

*² Only Analog Input.

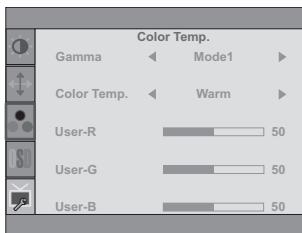
 Color Temp.











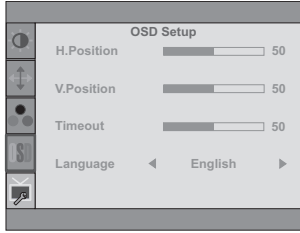



| Adjustment Item | Problem / Option | | Button to Press |
|-----------------|------------------|---------------|--|
| Gamma | Mode1 | Normal | |
| | Mode2 | High contrast | |
| | Mode3 | Dark | |
| Color Temp. | User | User-R | Too weak  <input data-bbox="953 464 1005 494" type="button" value="+"/> |
| | | User-G | |
| | | User-B | |
| | Warm | | |
| | Normal | | |
| Cool | | | |
| sRGB | | | |

NOTE

- sRGB is an international standard which defines and unifies the difference of color appearance between equipment.
- You can not adjust the Brightness, Contrast, Gamma and Eco during sRGB mode because those settings are locked.

OSD OSD Setup



| Adjustment Item | Problem / Option | | Button to Press | |
|-----------------|---|---------|---|--|
| H.Position | OSD is too left OSD is too right | |   |   |
| V.Position | OSD is too low OSD is too high | |   |   |
| Timeout | You can set the OSD display duration time between 5 and 60 seconds. | |  |   |
| Language | English | English | Portuguese | Portuguese |
| | Deutsch | German | 简体中文 | Simplified Chinese |
| | Français | French | Русский | Russian |
| | Español | Spanish | 日本語 | Japanese |
| | Italiano | Italian | | |

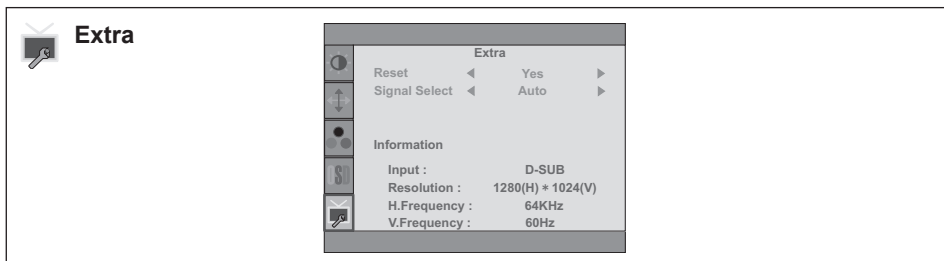

| Adjustment Item | Problem / Option | | Button to Press |
|-----------------------------|--|--|-----------------|
| Reset | Yes | Factory-preset data is restored. | |
| | No | Return to Menu. | |
| Signal Select Direct | Auto | Select the signal input automatically. | |
| | D-SUB | Select the Analog input. | |
| | DVI | Select the Digital (DVI) input. | |
| Information | Displays information regarding the current input signal coming from the graphic card in your computer. | | |
| | NOTE See your graphic card user guide for more information about changing the resolution and refresh. | | |

Direct

You can skip the Menu items and directly display an option setting screen by using the following button operations.

- Signal Select: Press the AUTO Button when the Menu is not displayed, it shows following Menu. Press the AUTO Button again to select input source and then press the MENU Button.

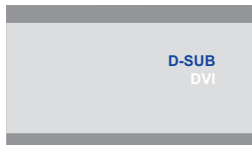

Direct

You can skip the Menu items and directly display an adjustment scale or perform adjustment by using the following button operations.

- Auto Adjust: Press and hold the AUTO Button for 3-4 seconds when the Menu is not displayed.

Only Analog Input

| Adjustment Item | Problem / Option | Button to Press |
|-----------------|---|-----------------|
| Auto Adjust * | Adjust H. / V. Position, Clock and Phase automatically. | |

* For best results, use the Auto Adjust in conjunction with the adjustment pattern. See page 22 for SCREEN ADJUSTMENTS.

- Lock Mode:

<OSD>

Hold the MENU Button and turn on the monitor when the monitor is power-off, it will lock/unlock the OSD Key Lock function.

<Power/OSD>

Pressing and holding the MENU Button for 10 seconds when Menu is not displayed, will lock/unlock the Power/OSD Key Lock function.

SCREEN ADJUSTMENTS

Adjust the image by following the procedure below to get the desired picture when selecting Analog input.

- The screen adjustments described in this manual are designed to set image position and minimize flicker or blur for the particular computer in use.
- The monitor is designed to provide the best performance at resolution of 1280 × 1024, but can not provide the best at resolutions of less than 1280 × 1024 because the picture is automatically stretched to fit the full screen. It is recommended to operate at resolution of 1280 × 1024 in normal use.
- Displayed text or lines will be blurred or irregular in thickness when the picture is stretched due to the screen enlargement process.
- It is preferable to adjust the image position and frequency with the monitor controls, rather than the computer software or utilities.
- Perform adjustments after a warm-up period of at least thirty minutes.
- Additional adjustments may be required after the Auto Adjust depending on the resolution or signal timing.
- The Auto Adjust may not work correctly when displaying the picture other than the screen adjustment pattern. In this case, manual adjustments are required.

There are two ways to adjust the screen. One way is automatic adjustment for Position, Clock and Phase. The other way is performing each adjustment manually.

Perform the Auto Adjust first when the monitor is connected to a new computer, or resolution is changed. If the screen has a flicker or blur, or the picture does not fit in the display area after performing the Auto Adjust, manual adjustments are required. Both adjustments should be made by using the screen adjustment pattern (Test.bmp) obtained via the Iiyama web site (<http://www.iiyama.com>).

Adjust the image by following the procedure below to get the desired picture.

This manual explains adjustment under Windows® OS.

- ① **Display the picture at the optimum resolution.**
- ② **Enter the Test.bmp (screen adjustment pattern) to wallpaper.**

NOTE

- Consult the appropriate documentation for doing this.
- Set the display position to center in the wallpaper setting dialogue box.

[Adjustment pattern]

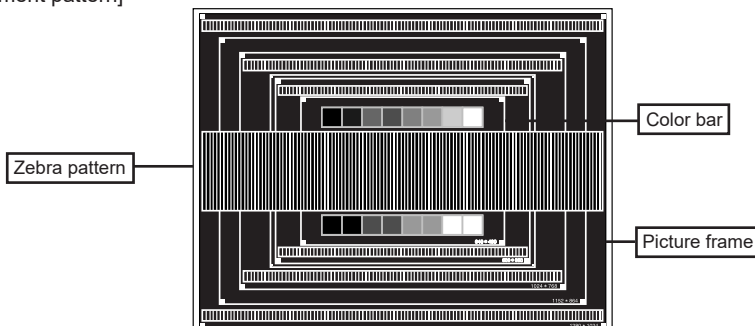

- ③ Pressing and holding of the AUTO Button for about 3-4 seconds. (Auto Adjust)
- ④ Adjust the image manually by following procedure below when the screen has a flicker or blur, or the picture does not fit in the display area after performing the Auto Adjust.
- ⑤ Adjust the V.Position so that the top and bottom of the picture frame will fit to the display area.

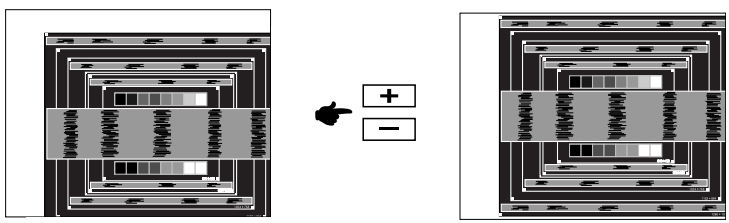

- ⑥ 1) Adjust the H.Position so that the left side of the picture frame will move to the left edge of the display area.

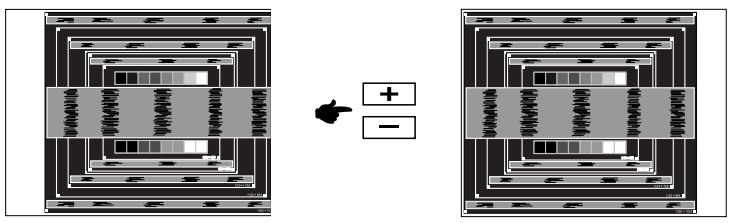

- 2) Stretch the right side of the picture frame to the right edge of the display area by adjusting the Clock.

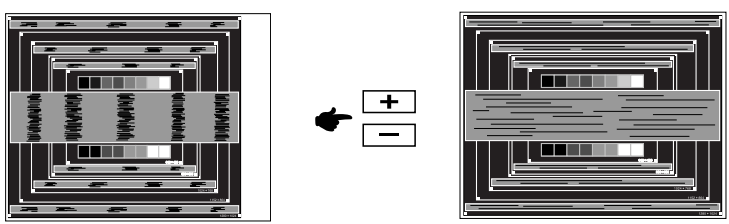

NOTE

- When the left side of the picture frame moves apart from the left edge of the display area during the Clock adjustment, adjust steps 1) and 2).
- Another way to make the Clock adjustment is to correct the vertical wavy lines in the zebra pattern.
- The picture may flicker during the Clock, H.Position and V.Position adjustment.
- In case the picture frame is bigger or smaller than the data display area after the Clock adjustment, repeat steps from ③.

⑦ Adjust the Phase to correct horizontal wavy noise, flicker or blur in the zebra pattern.

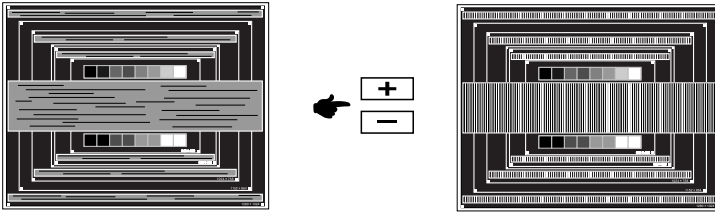

NOTE

- In case the strong flicker or blurs remain on a part of the screen, repeat steps ⑥ and ⑦ because the Clock may not be adjusted correctly. If the flicker or blurs still remain, set the refresh rate of computer to low (60Hz) and repeat steps from ③ again.
- Adjust the H.Position after the Phase adjustment if the horizontal position moves during the adjustment.

⑧ Adjust the Brightness and Color to get the desired picture after you complete the Clock and Phase adjustments.

Put back your favorite wallpaper.

STANDBY FEATURE

This product features the standby function. When activated, it automatically reduces unnecessary power consumption of the monitor when your computer is not in use.

There is a standby step the monitor takes as described below. The standby function, including any timer settings is configured by the operating system. Check your operating system manual for information on how this can be configured.

■ Standby Mode

When the video signal from the computer is off, the monitor enters into Standby Mode which reduces the power consumption to less than 0.5W. The screen becomes dark, and the power indicator turns to orange. From Standby Mode, the image reappears in several seconds when either the keyboard or the mouse are touched again.

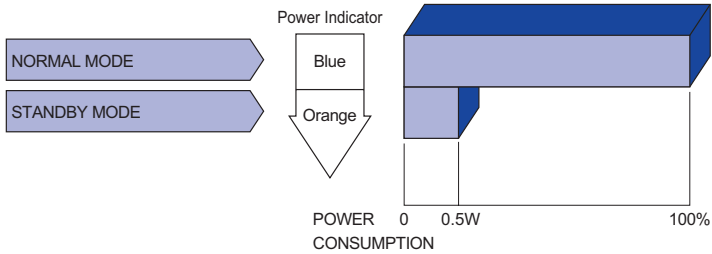

TROUBLE SHOOTING

If the monitor fails to operate correctly, please follow the steps below for a possible solution.

1. Perform the adjustments described in OPERATING THE MONITOR, depending on the problem you have. If the monitor does not get a picture, skip to 2.
2. Consult the following items if you cannot find an appropriate adjustment item in OPERATING THE MONITOR or if the problem persists.
3. If you are experiencing a problem which is not described below or you cannot correct the problem, discontinue using the monitor and contact your dealer or iiyama service center for further assistance.

Problem

Check

- ① The picture does not appear.

(Power indicator does not light up.)

- The Power Cable is firmly seated in the socket.
- The Power Switch is turned ON.
- The AC socket is live. Please check with another piece of equipment.

(Power indicator is blue.)

- If the blank screen saver is in active mode, touch the keyboard or the mouse.
- Increase the Contrast and/or Brightness.
- The computer is ON.
- The Signal Cable is properly connected.
- The signal timing of the computer is within the specification of the monitor.

(Power indicator is orange.)

- If the monitor is in standby mode, touch the keyboard or the mouse.
- The computer is ON.
- The Signal Cable is properly connected.
- The signal timing of the computer is within the specification of the monitor.

- ② The screen is not synchronized.

- The Signal Cable is properly connected.
- The signal timing of the computer is within the specification of the monitor.

- ③ The screen position is not in the center.

- The signal timing of the computer is within the specification of the monitor.

- ④ The screen is too bright or too dark.

- The video output level of the computer is within the specification of the monitor.

- ⑤ The screen is shaking.

- The power voltage is within the specification of the monitor.
- The signal timing of the computer is within the specification of the monitor.

RECYCLING INFORMATION

For better environment protection please don't dispose your monitor.
Please visit our web site: www.iiyama.com for monitor recycling.

APPENDIX

Design and specifications are subject to change without prior notice.

SPECIFICATIONS : ProLite B1980D-B5 / ProLite B1980D-W5

ENGLISH

| | | |
|------------------------------|------------------|--|
| Size Category | | 19" |
| LCD Panel | Panel technology | TN |
| | Size | Diagonal: 19" (48cm) |
| | Pixel pitch | 0.294mm H × 0.294mm V |
| | Brightness | 250cd/m ² (Typical), 200cd/m ² (Default / Energy Saving) |
| | Contrast ratio | 1000 : 1 (Typical), Adv. Contrast Function Available |
| | Viewable angle | Right / Left: 85 degrees each Up:75 degrees Down: 85 degrees (Typical) |
| | Response time | 5ms (Black, White, Black, Typical) |
| Display Colors | | Approx.16.7M |
| Sync Frequency | | Analog: Horizontal: 24.0-80.0kHz, Vertical: 56-75Hz Digital: Horizontal: 30.0-80.0kHz, Vertical: 56-75Hz |
| Native Resolution | | 1280 × 1024, 1.3 MegaPixels |
| Supported max. resolution | | VGA: 1280 × 1024, 60Hz DVI: 1280 × 1024, 60Hz |
| Input Connector | | VGA, DVI-D |
| Input Sync Signal | | Separate sync: TTL, Positive or Negative |
| Input Video Signal | | Analog: 0.7Vp-p (Standard), 75Ω, Positive Digital: DVI (Digital Visual Interface Standard Rev.1.0) compliance |
| Maximum Screen Size | | 376.32mm W × 301.05mm H / 14.8" W × 11.9" H |
| Power Source | | 100-240VAC, 50/60Hz, 1.5A |
| Power Consumption | | 16W typical, Standby mode: 0.5W maximum, Off mode: 0.3W maximum |
| Dimensions / Net Weight | | 411.0 × 453.0 - 603.0 × 245.5mm / 16.2 × 17.8 - 23.7 × 9.7" (W×H×D) 4.7kg / 10.4lbs |
| Angle | | Tilt: Upward: 23 degrees, Downward: 5 degrees Swivel: Left / Right : 45 degrees each Rotation: Clockwise: 90 degrees |
| Environmental Considerations | | Operating: Temperature 5 to 35°C / 41 to 95°F Humidity 10 to 80% (No condensation) Storage: Temperature -20 to 60°C / -4 to 140°F Humidity 5 to 85% (No condensation) |
| Approvals | | CE, UKCA, TÜV-GS, ENERGY STAR® |

SPECIFICATIONS : ProLite E1980D-B1

| | | |
|------------------------------|--|--|
| Size Category | 19" | |
| LCD Panel | Panel technology | TN |
| | Size | Diagonal: 19" (48cm) |
| | Pixel pitch | 0.294mm H × 0.294mm V |
| | Brightness | 250cd/m ² (Typical), 200cd/m ² (Default / Energy Saving) |
| | Contrast ratio | 1000 : 1 (Typical), Adv. Contrast Function Available |
| | Viewable angle | Right / Left: 85 degrees each Up:75 degrees Down: 85 degrees (Typical) |
| | Response time | 5ms (Black, White, Black, Typical) |
| Display Colors | Approx.16.7M | |
| Sync Frequency | Analog: Horizontal: 24.0-80.0kHz, Vertical: 56-75Hz Digital: Horizontal: 30.0-80.0kHz, Vertical: 56-75Hz | |
| Native Resolution | 1280 × 1024, 1.3 MegaPixels | |
| Supported max. resolution | VGA: 1280 × 1024, 60Hz DVI: 1280 × 1024, 60Hz | |
| Input Connector | VGA, DVI-D | |
| Input Sync Signal | Separate sync: TTL, Positive or Negative | |
| Input Video Signal | Analog: 0.7Vp-p (Standard), 75Ω, Positive Digital: DVI (Digital Visual Interface Standard Rev.1.0) compliance | |
| Maximum Screen Size | 376.32mm W × 301.05mm H / 14.8" W × 11.9" H | |
| Power Source | 100-240VAC, 50/60Hz, 1.5A | |
| Power Consumption | 16W typical, Standby mode: 0.5W maximum, Off mode: 0.3W maximum | |
| Dimensions / Net Weight | 411.0 × 402.0 × 204.5mm / 16.2 × 15.8 × 8.0" (W×H×D) 3.2kg / 7.1lbs | |
| Tilt Angle | Upward: 21 degrees, Downward: 4 degrees | |
| Environmental Considerations | Operating: Temperature 5 to 35°C / 41 to 95°F Humidity 10 to 80% (No condensation) Storage: Temperature -20 to 60°C / -4 to 140°F Humidity 5 to 85% (No condensation) | |
| Approvals | CE, UKCA, TÜV-GS, ENERGY STAR® | |

DIMENSIONS : ProLite B1980D-B5 / ProLite B1980D-W5

ENGLISH

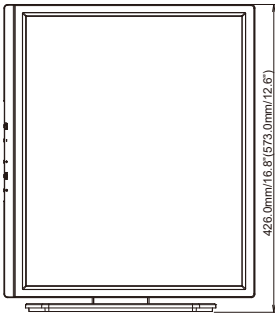
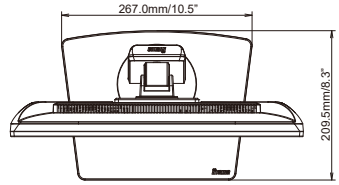
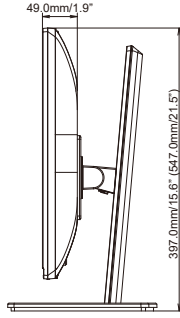
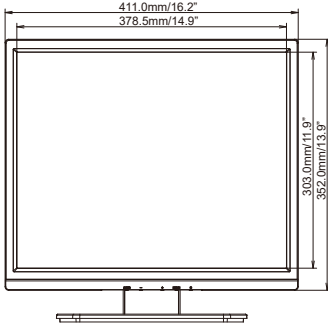

() : Maximum adjustment range

DIMENSIONS : ProLite E1980D-B1

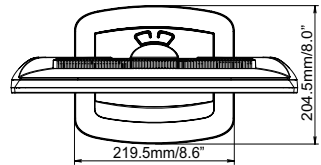
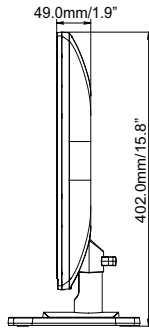
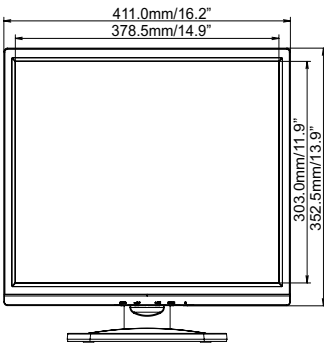

COMPLIANT TIMING

| Video Mode | Horizontal Frequency | Vertical Frequency | Dot Clock | |
|-------------|----------------------|--------------------|------------|---|
| 640 × 480 | 31.469kHz | 59.940Hz | 25.175MHz | |
| | 37.500kHz | 75.000Hz | 31.500MHz | |
| | 37.861kHz | 72.809Hz | 31.500MHz | |
| 800 × 600 | 35.156kHz | 56.250Hz | 36.000MHz | |
| | 37.879kHz | 60.317Hz | 40.000MHz | |
| | 46.875kHz | 75.000Hz | 49.500MHz | |
| | 48.077kHz | 72.188Hz | 50.000MHz | |
| 1024 × 768 | 48.363kHz | 60.004Hz | 65.000MHz | |
| | 56.476kHz | 70.069Hz | 75.000MHz | |
| | 60.023kHz | 75.029Hz | 78.750MHz | |
| 1280 × 1024 | 63.981kHz | 60.020Hz | 108.000MHz | |
| | 79.976kHz | 75.025Hz | 135.000MHz | |
| 640 × 480 | 35.000kHz | 66.667Hz | 30.240MHz | * |
| 832 × 624 | 49.725kHz | 74.500Hz | 57.283MHz | * |
| 1024 × 768 | 60.150kHz | 74.720Hz | 80.000MHz | * |
| 640 × 400 | 24.827kHz | 56.424Hz | 21.053MHz | * |

NOTE * Digital input is not compliant.