

USER MANUAL

Pro Lite

LCD Monitor

ENGLISH

Pro Lite XUB2493QSU

Thank you very much for choosing the iiyama LCD monitor.

We recommend that you take a few minutes to read carefully through this brief but comprehensive manual before installing and switching on the monitor. Please keep this manual in a safe place for your future reference.



Dear user, we congratulate you on the purchase of your iiyama LCD.

For details on warranty and locally used pixel policies that apply directly after installation of your product please check the iiyama website.

To report a fault, please contact your local support centre found at <https://iiyama.com>

Things to check before you call the iiyama information line

- | if the power cable is connected securely and turned on?
- | if the display has been turned on?
- | if the signal cable is connected securely and the correct input selected?
- | if the computer has been restarted with the display connected?
- | if the graphics card is correctly installed with the latest drivers possible?
- | if the correct native resolution has been selected via 'Display Properties'?
- | If the R/G/B signal configuration is correct?
- | if the displays On Screen Menu is shown?
- | if the correct brightness and contrast settings have been set?
- | if given display tolerances and compatibility have been considered?
- | if via the On Screen Menu you have performed a Factory Reset/Recall?

Before reporting the screen defect, please prepare the following information/evidence:

- | model number *
- | purchase receipt and serial number *
- | name and address for collection
- | telephone/fax number, for availability during the day
- | convenient collection date (date, time)
- | short description of the defect

Important Note:

If there is no fault found in the collected equipment after inspection, the transferring party shall incur charges for transport and administration.

If you have checked all of the above and there is still no picture, call our information line for assistance in your country.

* see the identification plate on the back of the case.

CE MARKING DECLARATION OF CONFORMITY

This LCD monitor complies with the requirements of the EC/EU Directive 2014/30/EU "EMC Directive", 2014/35/EU "Low Voltage Directive", 2009/125/EC "ErP Directive" and 2011/65/EU "RoHS Directive".

The electro-magnetic susceptibility has been chosen at a level that gives correct operation in residential areas, business and light industrial premises and small-scale enterprises, inside as well as outside of the buildings. All places of operation are characterised by their connection to the public low voltage power supply system.

IYAMA CORPORATION: Wijkmeerstraat 8, 2131 HA Hoofddorp, The Netherlands

Model No. : PL2493Q

An approved power cord greater or equal to H05VVF, 3G, 0.75mm² must be used.



We recommend recycling of used product. Please contact your dealer or iiyama service center. Recycle information is obtained via the Internet, using the address: <https://iiyama.com>

You can access the Web page of different countries from there.

- We reserve the right to change specifications without notice.
- All trademarks used in this user manual are the property of their respective owners.
- As an ENERGY STAR® Partner, iiyama has determined that this product meets the ENERGY STAR® guidelines for energy efficiency.
- This product qualifies for ENERGY STAR® in the "factory default" setting and this is the setting in which power saving will be achieved. Changing the factory default picture settings or enabling other features will increase power consumption that could exceed the limits necessary to qualify for ENERGY STAR® rating.
- Eprel registration number ProLite XUB2493QSU-B5 : 1328692

TABLE OF CONTENTS

FOR YOUR SAFETY.....	1
SAFETY PRECAUTIONS.....	1
SPECIAL NOTES ON LCD MONITORS.....	3
CUSTOMER SERVICE.....	3
CLEANING.....	3
BEFORE YOU OPERATE THE MONITOR.....	4
FEATURES.....	4
CHECKING THE CONTENTS OF THE PACKAGE.....	4
USING ARM OR STAND.....	5
FITTING AND REMOVAL OF STAND.....	7
CONTROLS AND CONNECTORS.....	8
CONNECTING YOUR MONITOR.....	9
DISCONNECTING YOUR MONITOR.....	10
COMPUTER SETTING.....	10
ADJUSTING THE HEIGHT AND THE VIEWING ANGLE.....	11
OPERATING THE MONITOR.....	12
ADJUSTMENT MENU CONTENTS.....	13
STANDBY FEATURE.....	22
TROUBLE SHOOTING.....	23
RECYCLING INFORMATION.....	24
APPENDIX.....	25
SPECIFICATIONS.....	25
DIMENSIONS.....	26
COMPLIANT TIMING.....	26

FOR YOUR SAFETY

SAFETY PRECAUTIONS

WARNING

STOP OPERATING THE MONITOR IF YOU ARE AWARE OF ANY PROBLEMS

If you notice any abnormal phenomena such as smoke, strange sounds or fumes, unplug the monitor and contact your dealer or iiyama service center immediately. Further use may be dangerous and can cause fire or electric shock.

NEVER REMOVE THE CABINET

High voltage circuits are inside the monitor. Removing the cabinet may expose you to the danger of fire or electric shock.

DO NOT PUT ANY OBJECT INTO THE MONITOR

Do not put any solid objects or liquids such as water into the monitor. In case of an accident, unplug your monitor immediately and contact your dealer or iiyama service center. Using the monitor with any object inside may cause fire, electric shock or damage.

INSTALL THE MONITOR ON A FLAT, STABLE SURFACE

The monitor may cause an injury if it falls or is dropped.

DO NOT USE THE MONITOR NEAR WATER

Do not use where water may be splashed or spilt onto the monitor as it may cause fire or electric shock.

OPERATE UNDER THE SPECIFIED POWER SUPPLY

Be sure to operate the monitor only with the specified power supply. Use of an incorrect voltage will cause malfunction and may cause fire or electric shock.

PROTECT THE CABLES

Do not pull or bend the power cable and signal cable. Do not place the monitor or any other heavy objects on the cables. If damaged, the cables may cause fire or electric shock.

ADVERSE WEATHER CONDITIONS

It is advisable not to operate the monitor during a heavy thunder storm as the continual breaks in power may cause malfunction. It is also advised not to touch the plug in these circumstances as it may cause electric shock.

CAUTION

INSTALLATION LOCATION

Do not install the monitor where sudden temperature changes may occur, or in humid, dusty or smoky areas as it may cause fire, electric shock or damage. You should also avoid areas where the sun shines directly on the monitor.

DO NOT PLACE THE MONITOR IN A HAZARDOUS POSITION

The monitor may topple and cause injury if not suitably located. Please also ensure that you do not place any heavy objects on the monitor, and that all cables are routed such that children may not pull the cables and possibly cause injury.

MAINTAIN GOOD VENTILATION

Ventilation slots are provided to keep the monitor from overheating. Covering the slots may cause fire. To allow adequate air circulation, place the monitor at least 10cm (or 4 inches) from any walls.

When removing the tilt stand, the ventilation slots on the back side of the monitor can be blocked. This may overheat the monitor and may cause fire or damage. Make sure to allow enough ventilation when removing the tilt stand. Operating the monitor on its back, side, upside down or on a carpet or any other soft material may also cause damage.

DISCONNECT THE CABLES WHEN YOU MOVE THE MONITOR

When you move the monitor, turn off the power switch, unplug the monitor and be sure the signal cable is disconnected. If you do not disconnect them, it may cause fire or electric shock.

UNPLUG THE MONITOR

If the monitor is not in use for a long period of time it is recommended that it is left unplugged to avoid accidents.

HOLD THE PLUG WHEN DISCONNECTING

To disconnect the power cable or signal cable, always pull it by the plug. Never pull on the cable itself as this may cause fire or electric shock.

DO NOT TOUCH THE PLUG WITH WET HANDS

Pulling or inserting the plug with wet hands may cause electric shock.

WHEN YOU INSTALL THE MONITOR ON YOUR COMPUTER

Be sure the computer is strong enough to hold the weight of the monitor, otherwise, you may damage your computer.

CAREFUL! PROTECT YOUR HANDS AND FINGERS

- Be careful not to hurt your fingers or hands when you change the height or the angle.
- Injury can occur if care is not taken to avoid finger contact with the displays base when adjusting the height.

REMARK FOR 24/7 USAGE

This product is not specifically designed for 24/7 usage in all environments.

REMARK FOR WALL MOUNTING

This product is not designed for digital signage (electronic signboard) applications such as wall mounting.

OTHERS

ERGONOMIC RECOMMENDATIONS

To eliminate eye fatigue, do not operate the monitor against a bright background or in a dark room. For optimal viewing comfort, the monitor should be just below eye level and 40-60 cm (16-24 inches) away from your eyes. When using the monitor over a prolonged time, a ten minute break every hour is recommended as looking at the screen continuously can cause eye strain.

SPECIAL NOTES ON LCD MONITORS

The following symptoms are normal with LCD monitors and do not indicate a problem.

- NOTE**
- When you first turn on the LCD monitor, the picture may not fit in the display area because of the type of computer that is used. In this case, adjust the picture position to the correct position.
 - You may find slightly uneven brightness on the screen depending on the desktop pattern you use.
 - Due to the nature of the LCD screen, an afterimage of the previous screen may remain after switching the image, when the same image is displayed for hours. In this case, the screen can be recovered slowly by changing the image or turning off the Power Switch for some hours.

CUSTOMER SERVICE

- NOTE**
- If you have to return your unit for service and the original packaging has been discarded, please contact your dealer or iiyama service center for advice or replacement packaging.

CLEANING

- WARNING**
- If you drop any materials or liquids such as water into the monitor when cleaning, unplug the power cable immediately and contact your dealer or iiyama service center.

- CAUTION**
- For safety reasons, turn off the power switch and unplug the monitor before you clean it.

- NOTE**
- To protect the LCD panel, do not scratch or rub the screen with a hard object.
 - Never use any of the following strong solvents. These will damage the cabinet and the LCD screen.

Thinner	Spray-type cleaner
Benzine	Wax
Abrasive cleaner	Acid or Alkaline solvent

- Touching the cabinet with any product made from rubber or plastic for a long time may cause degeneration or loss of paint on the cabinet.

CABINET Stains can be removed with a cloth lightly moistened with a mild detergent solvent. Then wipe the cabinet with a soft dry cloth.

LCD Periodic cleaning with a soft dry cloth is recommended.

SCREEN Don't use tissue paper etc. because these will damage the LCD screen.

BEFORE YOU OPERATE THE MONITOR

FEATURES

- ◆ Supports Resolutions up to 2560 × 1440
- ◆ High Contrast 1000:1 (Typical), Adv. Contrast Function Available / Brightness 300cd/m² (Typical)
- ◆ Blue Light Reducer
- ◆ Flicker-Free
- ◆ Digital Character Smoothing
- ◆ Automatic Set-up
- ◆ Stereo Speakers
2 × 2W Stereo Speakers
- ◆ ENERGY STAR® Compliant
- ◆ Standby Feature
- ◆ VESA Mounting Standard (100mm×100mm) Compliant
- ◆ Keyhole for Security Lock

CHECKING THE CONTENTS OF THE PACKAGE

The following accessories are included in your package. Check to see if they are enclosed with the monitor. If anything is missing or damaged, please contact your local iiyama dealer or regional iiyama office.

- | | | |
|----------------|---------------------------|---------------------|
| ■ Power Cable* | ■ HDMI Cable | ■ DisplayPort Cable |
| ■ USB Cable | ■ Stand-Base with a screw | ■ Stand-Neck |
| ■ Screwdriver | ■ Safety Guide | ■ Quick Start Guide |

CAUTION

- * The rating of the Power Cable enclosed in 120V area is 10A/125V. If you are using a power supply higher than this rating, then a power cable with a rating of 10A/250V must be used. However, all guarantees and warranties are void for any problems or damage caused by a power cable not supplied by iiyama. An approved power cable greater or equal to H05VVf, 3G, 0.75mm² must be used.

USING ARM OR STAND

CAUTION

- Before installation, make sure the display arm or desk arm stand is strong enough to hold the necessary weight of the monitor and the mount.
- Panel angle adjustment range : 23° upward and 5° downward

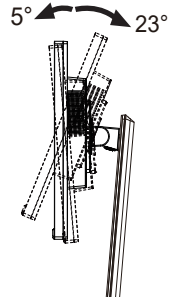

< DISPLAY ARM OR DESK ARM STAND >

CAUTION

When you use with the display arm or desk arm stand, in consideration of thickness of the mounting stage, tighten the M4 Screws (4pcs) which "L" length is 8mm to fasten the monitor. Using the screw longer than this may cause electric shock or damage because it may contact with the electrical parts inside the monitor.

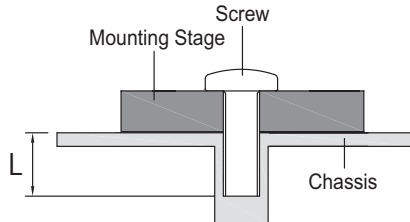

< ROTATING THE MONITOR >

The monitor is designed to be compatible with both landscape and portrait modes. Video card for portrait display will be required for rotating the image on the screen.

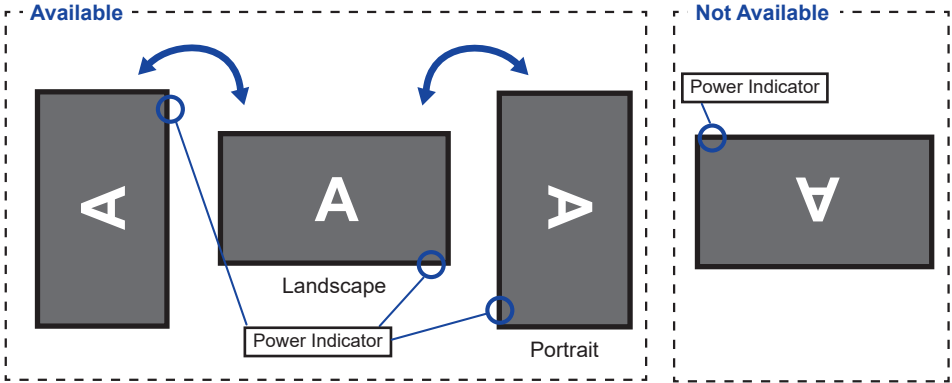

With Stand:

NOTE

- Adjust the monitor's height before panel rotation.
- Attempting to rotate the panel forcibly without adjusting the stand height may cause damage to the panel or the stand.

FITTING AND REMOVAL OF STAND

CAUTION

- Put the monitor on a stable surface. The monitor may cause injury or damage if it falls or is dropped.
- Do not give a strong impact to the monitor. It may cause damage.
- Unplug the monitor before removal or installation to avoid an electric shock or a damage.

<Installation>

- ① Put a piece of soft cloth on the table beforehand to prevent the monitor from being scratched. Lay the monitor flat on a table with front face down.
- ② Install the Stand-Neck to the monitor and then tighten the 'thumb screw' with the provided screwdriver to secure them.

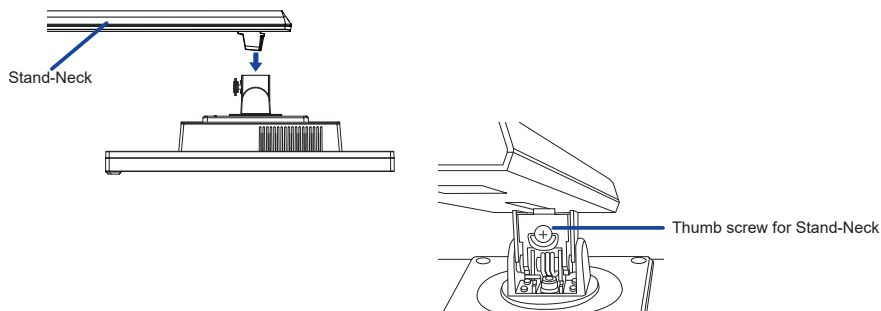

- ③ Install the Stand-Base to the Stand-Neck and then tighten the 'thumb screw' to secure them.

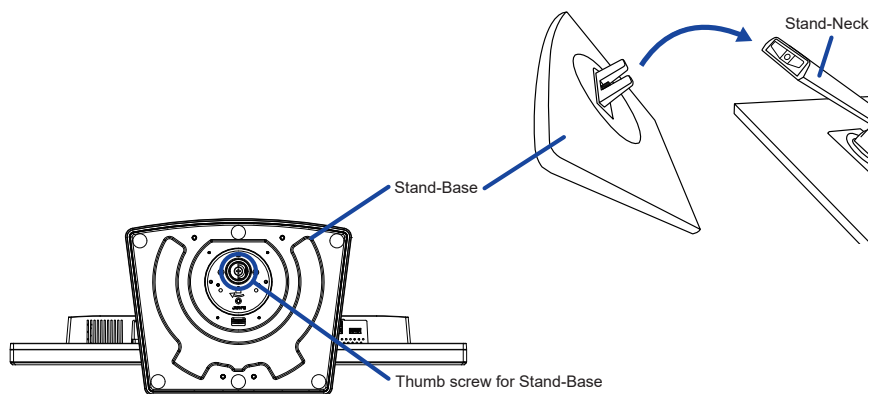

<Removal>

- ① Put a piece of soft cloth on the table beforehand to prevent the monitor from being scratched. Lay the monitor flat on a table with front face down.
- ② Loosen the 'thumb screw' to remove the Stand-Base from the Stand-Neck.
- ③ Loosen the 'thumb screw' with the provided screwdriver to remove the Stand-Neck from the monitor.





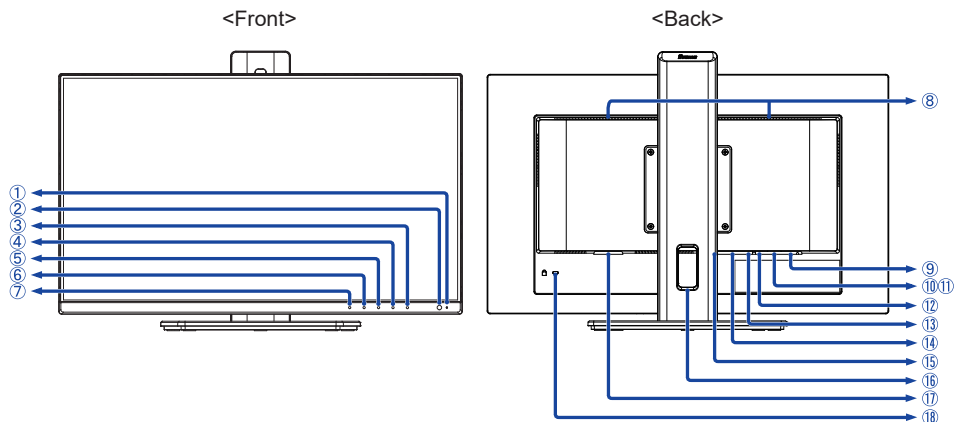



CONTROLS AND CONNECTORS

ENGLISH



- ① Power Indicator

NOTE Blue: Normal operation
Orange: Standby mode

- ② Power Switch ()
 ③ Menu Button (ENTER)
 ④ Up / Volume Button ( / )
 ⑤ Down / ECO Button ( / )
 ⑥ Exit / i-Style Color Button (EXIT)
 ⑦ Input Select Button (INPUT)
 ⑧ Speakers
 ⑨ USB Downstream Connector ( 5V, 500mA)
 ⑩ USB Downstream Connector ( 5V, 900mA)
 ⑪ USB Downstream Connector ( 5V, 900mA)
 ⑫ USB Upstream Connector ()
 ⑬ Headphone connector (HEADPHONE)
 ⑭ DisplayPort Connector (DP)
 ⑮ HDMI Connector (HDMI)
 ⑯ Cable Hole
 ⑰ AC Connector (AC IN) (~ : Alternating current)
 ⑱ Keyhole for Security Lock

NOTE You can fasten a security lock and cable to prevent the monitor from being removed without your permission.

CONNECTING YOUR MONITOR

- ① Ensure that both the computer and the monitor are switched off.
- ② Connect the computer to the monitor with the signal cable.
- ③ Connect the computer to the monitor with the USB Cable.
- ④ Connect the Power Cable to the monitor first and then to the power source.
- ⑤ Turn on your monitor and computer.

NOTE

- Make sure that the building installation has a circuit breaker of 120/240V, 20A (maximum).
- The signal cables used for connecting the computer and monitor may vary with the type of computer used. An incorrect connection may cause serious damage to both the monitor and the computer. The cable supplied with the monitor is for a standard connector. If a special cable is required please contact your local iiyama dealer or regional iiyama office.
- The Class I pluggable equipment Type A must be connected to protective earth.
- The socket-outlet shall be installed near the equipment and shall be easily accessible.
- Excessive sound pressure from ear/headphones can cause hearing damage/hearing loss.

[Example of Connection]

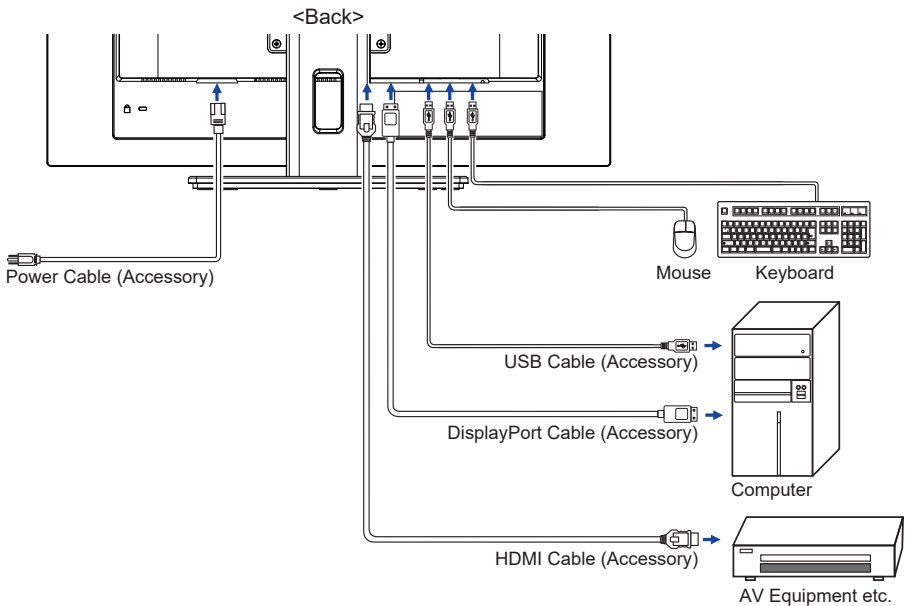

[Collect Cables]

Put the cables through the cable hole to bundle them.

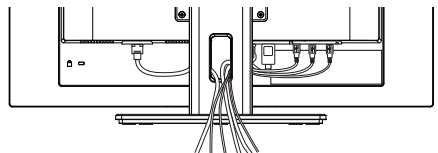

DISCONNECTING YOUR MONITOR

- ① Ensure that both the computer and the monitor are switched off.
- ② Disconnect the power source first and then the Power Cable from the monitor.
- ③ Disconnect the USB cable from the computer and the monitor.
- ④ Disconnect the signal cable from the computer and the monitor.

COMPUTER SETTING

■ Signal Timing

Change to the desired signal timing listed on page 26: COMPLIANT TIMING.

ADJUSTING THE HEIGHT AND THE VIEWING ANGLE

- For optimal viewing it is recommended to position yourself directly opposite to the full face of the monitor, then adjust the monitor's height and angle to your own preference.
- Hold the panel so that the monitor does not topple when you change the monitor's height or angle.
- You are able to adjust the monitor's height up to 150mm, angle up to 45 degrees right and left, 23 degrees upward and 5 degrees downward.

NOTE

- Do not touch the LCD screen when you change the height or the angle. It may cause damage or break the LCD screen.
- Careful attention is required not to pinch your fingers or hands into the moving part of the stand when you change the height or the angle.
- Injury can occur if care is not taken to avoid finger contact with the displays base when adjusting the height.

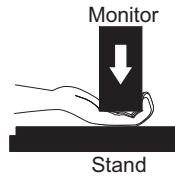
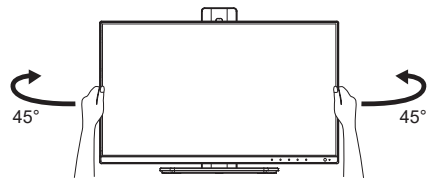
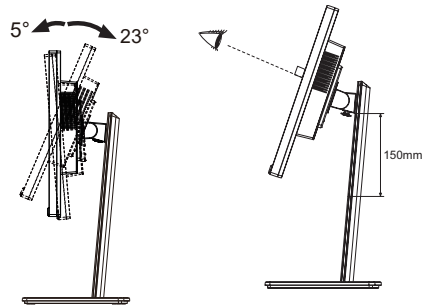

OPERATING THE MONITOR

To create the best picture, your iiyama LCD monitor has been preset at the factory with the COMPLIANT TIMING shown on page 26. You are also able to adjust the picture by following the button operation shown below.

- 1 Press the ENTER Button to start the On Screen Display feature. There are additional Menu items which can be switched by using the ◀/▶ Buttons.



- 2 Select the Menu item which contains the adjustment icon relating to the adjustment you want to make. Press the ENTER Button. Then, use the ◀/▶ Buttons to highlight the desired adjustment icon.
- 3 Press the ENTER Button again. Use the ◀/▶ Buttons to make the appropriate adjustment or setting.
- 4 Press the EXIT Button to leave the menu, and the settings you just made would be automatically saved.

For example, to correct for OSD vertical position, select "OSD" of Menu item and then press the ENTER Button. Then, select "OSD Vertical Position" by using the ◀/▶ Buttons. An adjustment page appears after you press the ENTER Button.

Then, use the ◀/▶ Buttons to change the OSD vertical position settings. The OSD vertical position should be changing accordingly while you are doing this.

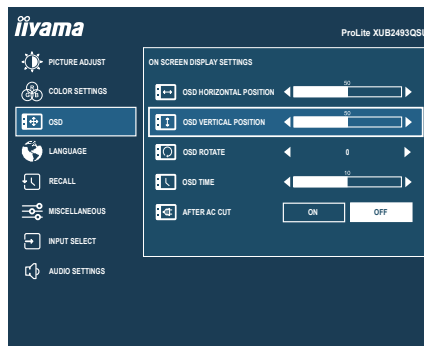

Press the EXIT Button lastly and all changes are saved in the memory.

NOTE

- When button operations are aborted during adjustment, On-Screen Display disappears when the time set for the OSD Timeout has passed. Also, press the EXIT button to quickly turn off the On-Screen Display.
- Any changes are automatically saved in the memory when the On Screen Display disappears. Turning off the power should be avoided while using the Menu.
- All adjustments have only one setting which applies to all signal timings.

ADJUSTMENT MENU CONTENTS

Picture Adjust

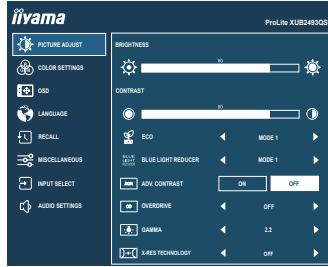

Adjustment Item	Problem / Option	Button to Press
Brightness* ^{1,2,3}	Too dark	
	Too bright	
Contrast * ²	Too dull	
	Too intense	
ECO * ⁴	Off	Normal
	Mode 1	Brightness of back-light is reduced.
	Mode 2	Brightness of back-light is reduced more than Mode 1.
	Mode 3	Brightness of back-light is reduced more than Mode 2.
Blue Light Reducer * ⁵	Off	Typical
	Mode 1	Blue light is reduced.
	Mode 2	Blue light is reduced more than Mode 1.
	Mode 3	Blue light is reduced more than Mode 2.
Adv. Contrast * ³	On	Increased Contrast Ratio
	Off	Typical Contrast Ratio
Overdrive	Off / 1 / 2 / 3 It will improve the gray level response time of the LCD panel. A higher level results in a faster response time.	
Gamma	1.8 / 2.0 / 2.2 / 2.4 You can set the Gamma.	
X-Res Technology	Off	Normal
	Soft	Enhance the picture edge.
	Middle	Enhance the picture edge more than the Soft option.
	Hard	Enhance the picture edge more than the Middle option.

- *¹ Adjust the Brightness when you are using the monitor in a dark room and feel the screen is too bright.
 *² Contrast and Brightness adjustment disabled when i-Style Color is set to Game or Movie or Text or Scenery.
 *³ Brightness and Adv. Contrast adjustment disabled when ECO is active.
 *⁴ ECO cannot be adjusted and selected while Adv. Contrast is active.
 *⁵ Blue Light Reducer is disabled when i-Style Color is activated.

Direct

You can skip the Menu items and directly display an option setting screen by using the following button operations.

- ECO : Press the  Button when the Menu is not displayed.

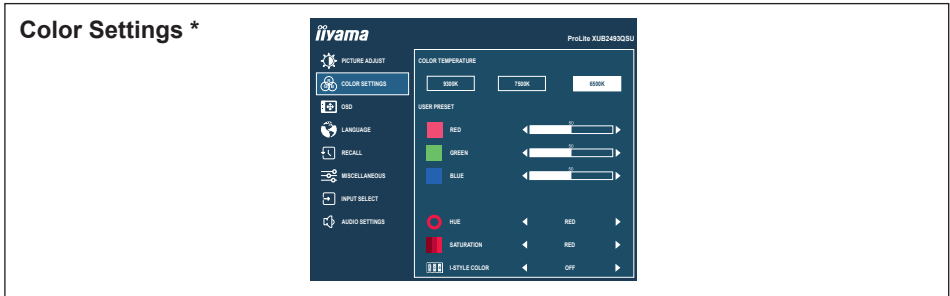

Adjustment Item	Problem / Option		Button to Press
Color Temperature	9300K	Cool color	
	7500K	Normal color	
	6500K	Warm color	
User Preset	Red	Too weak	➡
	Green	Too strong	⬅
	Blue		
Hue	Red	You can set the Colours.	➡
	Green		➡
	Blue		⬅
	Cyan		⬅
	Magenta		
	Yellow		
Saturation	Red	You can set the Colours.	➡
	Green		➡
	Blue		⬅
	Cyan		⬅
	Magenta		
	Yellow		
i-Style Color Direct	Off	Return to a state set by color adjustment except i-Style Color.	
	Standard	For general windows environment and monitor default setting.	
	Game	For PC game environment.	
	Cinema	For movie and video environment.	
	Scenery	For displaying outdoor scenery images	
	Text	For text editing and viewing in a word processing environment.	

* Color Settings adjustment is disabled when Blue Light Reducer is activated.

Direct







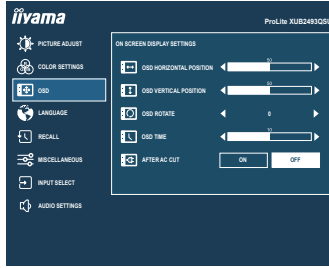





You can skip the Menu items and directly display an option setting screen by using the following button operations.

- i-Style Color : Press the EXIT Button when the Menu is not displayed.

OSD



ENGLISH

Adjustment Item	Problem / Option		Button to Press
OSD Horizontal Position	OSD is too left OSD is too right		   
OSD Vertical Position	OSD is too high OSD is too low		   
OSD Rotate	Rotate the OSD. 0° (Normal) / +90° (Rotate right) / -90° (Rotate left)		
OSD Time	You can set the OSD display duration time between 5 and 30 seconds.		   
After AC Cut	On	Monitors stays in off mode when power is back. NOTE To turn the monitor back on, press the power switch.	
	Off	When power is back, the monitor returns to the mode it was in before the AC was lost.	

Language

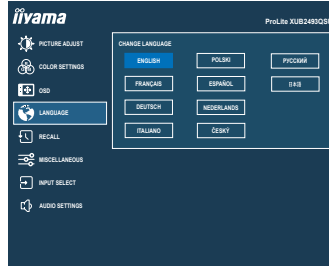

Adjustment Item	Problem / Option			
Language	English	English	Español	Spanish
	Français	French	Nederlands	Dutch
	Deutsch	German	Česky	Czech
	Italiano	Italian	Русский	Russian
	Polski	Polish	日本語	Japanese

ENGLISH



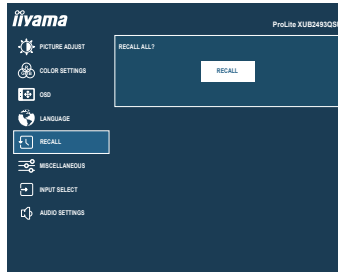

Recall

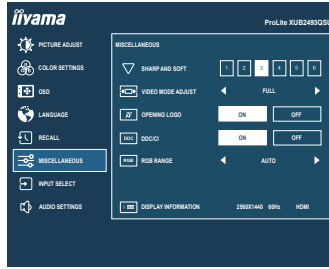

Adjustment Item	Problem / Option
Recall	Factory-preset data is restored.

Miscellaneous



Adjustment Item	Problem / Option		Button to Press
Sharp and Soft	1 2 3 4 5 6		 
	You can change the picture quality from 1 to 6 (sharp to soft). Press the  Button to change the picture quality in numerical order. Press the  Button to change the picture quality in reverse numerical order.		
Video Mode Adjust	Full	Expansion display	
	Aspect *	Expansion display of Aspect	
Opening Logo	On	iiyama Logo is displayed when the monitor is turned on.	
	Off	iiyama Logo is not displayed when the monitor is turned on.	
DDC/CI	On	Enable the DDC/CI function.	
	Off	DDC/CI function is turned Off.	
RGB Range	Auto	Automatically select color scale signal.	
	Full	For full-range color scale signal	
	Limited	For limited color scale signal	
Display Information	Displays information regarding the current input signal coming from the graphic card in your computer.		
	NOTE See your graphic card user guide for more information about changing the resolution and refresh.		

* Option unavailable with 16:9 resolution.

Input Select

Direct

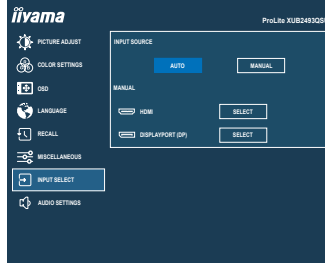

Adjustment Item	Problem / Option		
Input Source	Auto	Search for an available input source and select automatically.	
	Manual	HDMI	Select the Digital (HDMI) input.
		DisplayPort	Select the Digital (DisplayPort) input.

NOTE

Input source is fixed, not selected automatically when HDMI and DisplayPort which are selected.



Direct

You can skip the Menu items and directly display an option setting screen by using the following button operations.

- Input Select : Press the INPUT button when the Menu is not displayed.

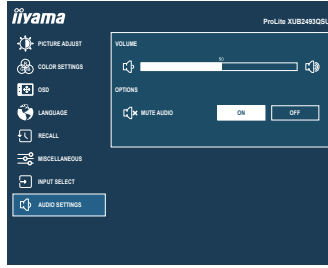
Audio Settings



Adjustment Item	Problem / Option		Button to Press
Volume Direct	Too soft Too loud		 
Mute Audio	On	Turn off the sound temporarily.	
	Off	Return the sound volume to the previous level.	

Direct

You can skip the Menu items and directly display an adjustment scale by using the following button operations.

- Volume : Press the  Button when the Menu is not displayed.

■ Lock Mode

<OSD Menu>

The OSD can be locked to avoid an accidental setting change.

1. Make sure the monitor is turned ON.
2. The OSD lock will be activated by pressing the front ENTER Button for about 10 seconds. If you try to access the OSD by pressing any of the buttons, a message "OSD Locked" will appear on the screen.
3. The OSD lock will be deactivated by pressing the front ENTER Button again for about 10 seconds.

<Power Switch>

The Power Switch can be locked to avoid an accidental power operation.

1. Make sure the monitor is turned ON.
2. The Power Switch lock will be activated by pressing the front ◀ Button for about 10 seconds. If you try to turn off the monitor by pressing the Power Switch, a message "Power Lock" will appear on the screen.
3. The Power Switch lock will be deactivated by pressing the front ◀ Button again for about 10 seconds.

STANDBY FEATURE

This product features the standby function. When activated, it automatically reduces unnecessary power consumption of the monitor when your computer is not in use.

There is a standby step the monitor takes as described below. The standby function, including any timer settings is configured by the operating system. Check your operating system manual for information on how this can be configured.

■ Standby Mode

When the video signal from the computer is off, the monitor enters into Standby Mode which reduces the power consumption to less than 0.5W*. The screen becomes dark, and the power indicator turns to orange. From Standby Mode, the image reappears in several seconds when either the keyboard or the mouse are touched again.

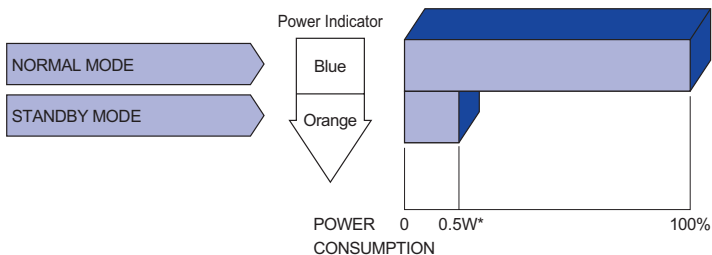

* When the USB devices are not connected.

TROUBLE SHOOTING

If the monitor fails to operate correctly, please follow the steps below for a possible solution.

1. Perform the adjustments described in OPERATING THE MONITOR, depending on the problem you have. If the monitor does not get a picture, skip to 2.
2. Consult the following items if you cannot find an appropriate adjustment item in OPERATING THE MONITOR or if the problem persists.
3. If you are experiencing a problem which is not described below or you cannot correct the problem, discontinue using the monitor and contact your dealer or iiyama service center for further assistance.

Problem	Check
<p>① The picture does not appear.</p> <p>(Power indicator does not light up.)</p> <p>(Power indicator is blue.)</p> <p>(Power indicator is orange.)</p>	<ul style="list-style-type: none"> <input type="checkbox"/> The Power Cable is firmly seated in the socket. <input type="checkbox"/> The Power Switch is turned ON. <input type="checkbox"/> The AC socket is live. Please check with another piece of equipment. <input type="checkbox"/> If the blank screen saver is in active mode, touch the keyboard or the mouse. <input type="checkbox"/> Increase the Contrast and/or Brightness. <input type="checkbox"/> The computer is ON. <input type="checkbox"/> The Signal Cable is properly connected. <input type="checkbox"/> The signal timing of the computer is within the specification of the monitor. <input type="checkbox"/> If the monitor is in standby mode, touch the keyboard or the mouse. <input type="checkbox"/> The computer is ON. <input type="checkbox"/> The Signal Cable is properly connected. <input type="checkbox"/> The signal timing of the computer is within the specification of the monitor.
<p>② The screen is not synchronized.</p>	<ul style="list-style-type: none"> <input type="checkbox"/> The Signal Cable is properly connected. <input type="checkbox"/> The signal timing of the computer is within the specification of the monitor.
<p>③ The screen position is not in the center.</p>	<ul style="list-style-type: none"> <input type="checkbox"/> The signal timing of the computer is within the specification of the monitor.
<p>④ The screen is too bright or too dark.</p>	<ul style="list-style-type: none"> <input type="checkbox"/> The video output level of the computer is within the specification of the monitor.
<p>⑤ The screen is shaking.</p>	<ul style="list-style-type: none"> <input type="checkbox"/> The power voltage is within the specification of the monitor. <input type="checkbox"/> The signal timing of the computer is within the specification of the monitor.

Problem

Check

⑥ No sound.

- The audio equipment (computer etc.) is ON.
- The Volume is turned up.
- The mute function is OFF.
- The audio output level of the audio equipment is within the specification of the monitor.

⑦ The sound is too loud or too quiet.

- The audio output level of the audio equipment is within the specification of the monitor.

RECYCLING INFORMATION

For better environment protection please don't dispose your monitor.
Please visit our web site: <https://iiyama.com> for monitor recycling.

APPENDIX

Design and specifications are subject to change without prior notice.

SPECIFICATIONS

Size Category	24"	
LCD Panel	Panel technology	IPS (In-Plane-Switching)
	Size	Diagonal: 23.8" (60.5cm)
	Pixel pitch	0.2058mm H × 0.2058mm V
	Brightness	300cd/m ² (Typical), 180cd/m ² (Default / Energy Saving)
	Contrast ratio	1000 : 1 (Typical), Adv. Contrast function available
	Viewable angle	Right / Left: 89 degrees each, Up / Down: 89 degrees each (Typical)
	Response time	4ms (Gray to Gray) ^{*1}
Display Colors	Approx. 16.7M	
Sync Frequency	Horizontal: 15.0-90.0kHz, Vertical: 49-75Hz	
Native Resolution	2560 × 1440, 2.3 MegaPixels	
Support max. resolution	HDMI: 2560 × 1440 60Hz DisplayPort: 2560 × 1440 60Hz	
Input Connector	HDMI, DisplayPort	
Input Video Signal	HDMI, DisplayPort	
USB Standard	USB3.0 (DC5V, 900mA) × 2, USB2.0 (DC5V, 500mA) × 1	
Number of USB Ports Connector shape	1 Upstream: Series B 3 Downstream: Series A	
Headphone Connector	ø 3.5mm mini jack (Stereo)	
Speakers	2W × 2 (Stereo speakers)	
Maximum Screen Size	526.85mm W × 296.35mm H / 20.7" W × 11.7" H	
Power Source	100-240VAC, 50/60Hz, 1.7A	
Power Consumption ^{*2}	17W typical Standby mode: 0.5W maximum, Off mode: 0.3W maximum	
Dimensions / Net Weight	539.5 × 343.0 - 493.0 × 209.5mm / 21.2 × 13.5 - 19.4 × 8.2" (W×H×D) 5.8kg / 12.8lbs	
Angle	Tilt: Upward: 23 degrees Downward: 5 degrees Swivel: Left/Right: 45 degrees each Rotation: Clockwise / Counterclockwise: 90 degrees each	
Environmental Considerations	Operating: Temperature 5 to 35°C / 41 to 95°F Humidity 10 to 80% (No condensation) Storage: Temperature -20 to 60°C / -4 to 140°F Humidity 5 to 85% (No condensation)	
Approvals	CE, UKCA, TÜV-Bauart, VCCI, EAC, PSE, ENERGY STAR [®]	

NOTE

^{*1} When set the Overdrive to level 2.

^{*2} When the USB devices are not connected.

DIMENSIONS

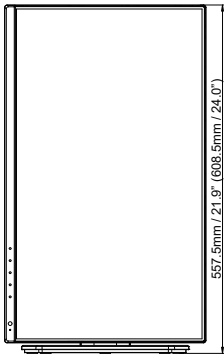
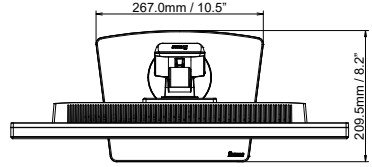
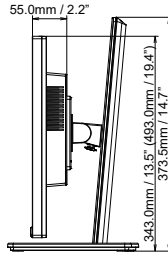
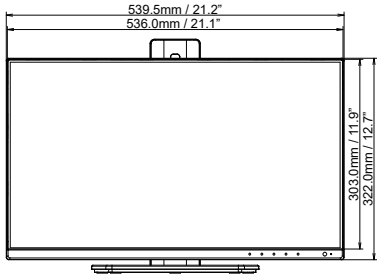

() : Maximum adjustment range

COMPLIANT TIMING

Video Mode	Horizontal Frequency	Vertical Frequency	Dot Clock
640 × 480	31.469kHz	59.940Hz	25.175MHz
	37.500kHz	75.000Hz	31.500MHz
800 × 600	37.879kHz	60.317Hz	40.000MHz
	46.875kHz	75.000Hz	49.500MHz
1024 × 768	48.363kHz	60.004Hz	65.000MHz
	60.023kHz	75.029Hz	78.750MHz
1280 × 1024	63.981kHz	60.020Hz	108.000MHz
	79.976kHz	75.025Hz	135.000MHz
1440 × 900	55.935kHz	59.887Hz	106.500MHz
1680 × 1050	65.290kHz	60.000Hz	146.250MHz
1920 × 1080	66.590kHz	59.930Hz	138.500MHz
1920 × 1200	74.038kHz	59.950Hz	154.000MHz
2560 × 1440	88.787kHz	59.951Hz	241.500MHz