

USER MANUAL

ProLite

LCD Monitor

ENGLISH

ProLite LE4341UHS
ProLite LE5041UHS
ProLite LE5541UHS

Thank you very much for choosing the iiyama LCD Monitor.

We recommend that you take a few minutes to read this comprehensive manual carefully before installing and switching on the monitor. Please keep this manual in a safe place for your future reference.



Dear user, we congratulate you on the purchase of your iiyama LCD.

For details on warranty and locally used pixel policies that apply directly after installation of your product please check the iiyama website.

To report a fault, please contact your local support centre found at <https://iiyama.com>

Things to check before you call the iiyama information line

- | if the power cable is connected securely and turned on?
- | if the display has been turned on?
- | if the signal cable is connected securely and the correct input selected?
- | if the computer has been restarted with the display connected?
- | if the graphics card is correctly installed with the latest drivers possible?
- | if the correct native resolution has been selected via 'Display Properties'?
- | If the R/G/B signal configuration is correct?
- | if the displays On Screen Menu is shown?
- | if the correct brightness and contrast settings have been set?
- | if given display tolerances and compatibility have been considered?
- | if via the On Screen Menu you have performed a Factory Reset/Recall?

Before reporting the screen defect, please prepare the following information/evidence:

- | model number *
- | purchase receipt and serial number *
- | name and address for collection
- | telephone/fax number, for availability during the day
- | convenient collection date (date, time)
- | short description of the defect

Important Note:

If there is no fault found in the collected equipment after inspection, the transferring party shall incur charges for transport and administration.

If you have checked all of the above and there is still no picture, call our information line for assistance in your country.

* see the identification plate on the back of the case.

CE MARKING DECLARATION OF CONFORMITY

This LCD display complies with the requirements of the EC/EU Directive 2014/30/EU "EMC Directive", 2014/35/EU "Low Voltage Directive", 2009/125/EC "ErP Directive" and 2011/65/EU "RoHS Directive".

Warning

This equipment is compliant with Class A of EN55032. In a residential environment this equipment may cause radio interference.

IYAMA CORPORATION: Wijkmeerstraat 8, 2131 HA Hoofddorp, The Netherlands

Model No. : PL4341U/PL5041U/PL5541U



We recommend recycling of used product. Please contact your dealer or iiyama service center. Recycle information is obtained via the Internet, using the address: <https://iiyama.com>

You can access the Web page of different countries from there.

- We reserve the right to change specifications without notice.
- All trademarks used in this user manual are the property of their respective owners.
- Eprel registration number LE4341UHS-B1: 1389991, LE5041UHS-B1: 1389276, LE5541UHS-B1: 1388030

TABLE OF CONTENTS

FOR YOUR SAFETY.....	1
SAFETY PRECAUTIONS.....	1
SPECIAL NOTES ON LCD MONITORS.....	3
CUSTOMER SERVICE.....	5
CLEANING.....	5
BEFORE YOU OPERATE THE MONITOR.....	6
FEATURES.....	6
CHECKING THE CONTENTS OF THE PACKAGE.....	6
UNPACKING.....	7
CONTROLS AND CONNECTORS.....	8
INSTALLATION.....	10
FUNCTIONS OF THE REMOTE CONTROL.....	11
PREPARING THE REMOTE CONTROL.....	12
BASIC OPERATION.....	14
CONNECTING YOUR MONITOR.....	17
COMPUTER SETTING.....	19
OPERATING THE MONITOR.....	20
ADJUSTMENT MENU CONTENTS.....	21
SCREEN ADJUSTMENTS.....	34
STANDBY FEATURE.....	37
TROUBLE SHOOTING.....	38
RECYCLING INFORMATION.....	39
APPENDIX.....	40
SPECIFICATIONS : ProLite LE4341UHS-B1.....	40
SPECIFICATIONS : ProLite LE5041UHS-B1.....	41
SPECIFICATIONS : ProLite LE5541UHS-B1.....	42
DIMENSIONS : ProLite LE4341UHS.....	43
DIMENSIONS : ProLite LE5041UHS.....	43
DIMENSIONS : ProLite LE5541UHS.....	43
COMPLIANT TIMING.....	44

FOR YOUR SAFETY

SAFETY PRECAUTIONS

WARNING

STOP OPERATING THE MONITOR WHEN YOU SENSE TROUBLE

If you notice any abnormal phenomena such as smoke, strange sounds or fumes, unplug the monitor and contact your dealer or iiyama service center immediately. Further use may be dangerous and can cause fire or electric shock.

NEVER REMOVE THE CABINET

High voltage circuits are inside the monitor. Removing the cabinet may expose you to the danger of fire or electric shock.

DO NOT PUT ANY OBJECT INTO THE MONITOR

Do not put any solid objects or liquids such as water into the monitor. In case of an accident, unplug your monitor immediately and contact your dealer or iiyama service center. Using the monitor with any object inside may cause fire, electric shock or damage.

INSTALL THE MONITOR ON A FLAT, STABLE SURFACE

The monitor may cause an injury if it falls or is dropped.

DO NOT USE THE MONITOR NEAR WATER

Do not use where water may be splashed or spilt onto the monitor as it may cause fire or electric shock.

OPERATE UNDER THE SPECIFIED POWER SUPPLY

Be sure to operate the monitor only with the specified power supply. Use of an incorrect voltage will cause malfunction and may cause fire or electric shock.

PROTECT THE CABLES

Do not pull or bend the power cable and signal cable. Do not place the monitor or any other heavy objects on the cables. If damaged, the cables may cause fire or electric shock.

ADVERSE WEATHER CONDITIONS

It is advisable not to operate the monitor during a heavy thunder storm as the continual breaks in power may cause malfunction. It is also advised not to touch the plug in these circumstances as it may cause electric shock.

CAUTION

INSTALLATION LOCATION

Do not install the monitor where sudden temperature changes may occur, or in humid, dusty or smoky areas as it may cause fire, electric shock or damage. You should also avoid areas where the sun shines directly on the monitor.

DO NOT PLACE THE MONITOR IN A HAZARDOUS POSITION

The monitor may topple and cause injury if not suitably located. Please also ensure that you do not place any heavy objects on the monitor, and that all cables are routed such that children may not pull the cables and possibly cause injury.

MAINTAIN GOOD VENTILATION

Ventilation slots are provided to keep the monitor from overheating. Covering the slots may cause fire. To allow adequate air circulation, place the monitor at least 10 cm (or 4 inches) from any walls. Operating the monitor on its back, side, upside down or on a carpet or any other soft material may also cause damage.

DISCONNECT THE CABLES WHEN YOU MOVE THE MONITOR

When you move the monitor, turn off the power switch, unplug the monitor and be sure the signal cable is disconnected. If you do not disconnect them, it may cause fire or electric shock.

UNPLUG THE MONITOR

If the monitor is not in use for a long period of time it is recommended that it is left unplugged to avoid accidents.

HOLD THE PLUG WHEN DISCONNECTING

To disconnect the power cable or signal cable, always pull it by the plug. Never pull on the cable itself as this may cause fire or electric shock.

DO NOT TOUCH THE PLUG WITH WET HANDS

Pulling or inserting the plug with wet hands may cause electric shock.

WHEN YOU INSTALL THE MONITOR ON YOUR COMPUTER

Be sure the computer is strong enough to hold the weight of the monitor, otherwise, you may damage your computer.

REMARK FOR 24/7 USAGE

This product is not specifically designed for 24/7 usage. (Recommended operating time is 18 hours/Day.)

OTHERS

ERGONOMIC RECOMMENDATIONS

To eliminate eye fatigue, do not operate the monitor against a bright background or in a dark room. For optimal viewing comfort, the monitor should be just below eye level and 40-60 cm (16-24 inches) away from your eyes. When using the monitor over a prolonged time, a ten minute break every hour is recommended as looking at the screen continuously can cause eye strain.

SPECIAL NOTES ON LCD MONITORS

- The following symptoms are normal with LCD monitors and do not indicate a problem.

NOTE

- When you first turn on the LCD monitor, the picture may not fit in the display area because of the type of computer that is used. In this case, adjust the picture position to the correct position.
 - You may find slightly uneven brightness on the screen depending on the desktop pattern you use.
 - Due to the nature of the LCD screen, an afterimage of the previous screen may remain after switching the image, when the same image is displayed for hours. In this case, the screen is recovered slowly by changing the image or turning off the Power Switch for hours.
- This LCD cannot be used outdoors.
 - This LCD cannot be used with the screen facing upwards.
 - If you use a cable longer than the supplied one, the picture quality is not guaranteed.

USAGE CONFIRMATION

This product is designed for optimum usage at 18hours per day.

The monitor is compatible for usage in Landscape applications.

IMAGE PERSISTENCE / IMAGE STICKING

Please be aware that all LCD screens can experience Image Persistence or Image Sticking. This occurs when a residual image remains visible on a screen when static images are displayed for long periods of time. LCD Image Persistence is not permanent but constant images being displayed for a long period of time should be avoided.

To counteract Image Persistence, turn off the monitor for as long as the previous image was displayed, so if an image was on the monitor for 1 hour and there is evidence of a residual or “ghost” image, you should turn off the monitor for 1 hour in order to clear the residual image.

For all LFD products, iiyama recommends displaying moving images and utilising a moving screen saver at regular intervals whenever the screen is idle. You could also turn off the monitor when not in use to assist the prevention.

Other ways to reduce the risk of Image Persistence will be to utilise the FAN-on function (if available), Low Backlight and Low Brightness settings.

FOR EXTENDED USE AS A PUBLIC MONITOR

■ Image Sticking on LCD Panel

When a static image is displayed for hours, an electric charge trace remains near the electrode inside the LCD producing a “ghost” image. (Image Persistence).

Image Persistence is not a permanent feature.

■ Recommendations

To prevent Image Sticking and promote longer life expectancy of monitor, we recommend the following:

1. Avoid static images displayed for long periods – change static images on continuous loop.
2. Turn off monitor when not in use, either by remote control or use Standby or Schedule functions.
3. Check the Monitor Menu Settings for "Pixel Shift" etc. and activate it when available. This will reduce the Image Sticking Effect.
4. When monitor is installed in high ambient temperature environment(s) or in an enclosed position, utilise the Cooling Fan, Screen Saver and Low Brightness functions.
5. Suitable ventilation for any monitor is an expectation of any installation – climate control systems may need to be employed.
6. We strongly recommend utilisation of active cooling with fans for long operation times or high ambient temperature environments.

CUSTOMER SERVICE

NOTE

- If you have to return your unit for service and the original packaging has been discarded, please contact your dealer or iiyama service center for advice or replacement packaging.

CLEANING

WARNING

- If you drop any materials or liquids such as water into the monitor when cleaning, unplug the power cable immediately and contact your dealer or iiyama service center.

CAUTION

- For safety reasons, turn off the power switch and unplug the monitor before you clean it.

NOTE

- To protect the LCD panel, do not scratch or rub the screen with a hard object.
- Never use any of the following strong solvents. These will damage the cabinet and the LCD screen.

Thinner	Benzine	Abrasive cleaner
Spray-type cleaner	Wax	Acid or Alkaline solvent

- Touching the cabinet with any product made from rubber or plastic for a long time may cause degeneration or loss of paint on the cabinet.

CABINET

Stains can be removed with a cloth lightly moistened with a mild detergent solvent. Then wipe the cabinet with a soft dry cloth.

LCD

Periodic cleaning with a soft dry cloth is recommended.

SCREEN

Don't use tissue paper etc. because these will damage the LCD screen.

BEFORE YOU OPERATE THE MONITOR

FEATURES

- ◆ Supports Resolutions up to 3840 × 2160
- ◆ High Contrast 1200:1 (Typical) / Brightness 350cd/m² (Typical) : ProLite LE4341UHS / ProLite LE5541UHS
- ◆ High Contrast 5000:1 (Typical) / Brightness 350cd/m² (Typical) : ProLite LE5041UHS
- ◆ Digital Character Smoothing
- ◆ Automatic Set-up
- ◆ Stereo Speakers
2 × 10W Stereo Speakers
- ◆ Standby Feature
- ◆ VESA Mounting Standard (200mm×200mm, 400mm×400mm) Compliant : ProLite LE4341UHS
- ◆ VESA Mounting Standard (400mm×200mm, 400mm×400mm) Compliant : ProLite LE5041UHS / ProLite LE5541UHS

CHECKING THE CONTENTS OF THE PACKAGE

The following accessories are included in your package. Check to see if they are enclosed with the monitor. If anything is missing or damaged, please contact your local iiyama dealer or regional iiyama office.

- | | | |
|---------------------|------------------|-----------------|
| ■ Power Cable* | ■ HDMI Cable | ■ RS-232C Cable |
| ■ Remote Control | ■ Battery (2pcs) | ■ Safety Guide |
| ■ Quick Start Guide | | |

CAUTION

- * The rating of the Power Cable enclosed in 120V area is 10A/125V. If you are using a power supply higher than this rating, then a power cable with a rating of 10A/250V must be used. However, all guarantees and warranties are void for any problems or damage caused by a power cable not supplied by iiyama. An approved power cable greater or equal to H05VVF, 3G, 0.75mm² must be used.

UNPACKING

CAUTION

Moving the monitor requires at least two people. If not, it may drop and could result in a serious injury.

CONTROLS AND CONNECTORS

<Back Controller>

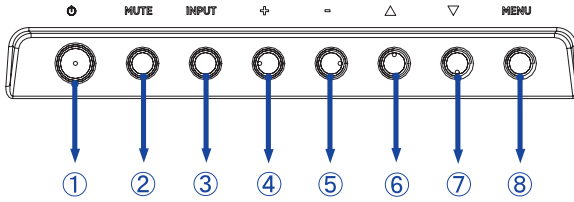

①		Power Button
②	MUTE	Mute Button
③	INPUT	Enter / Input Select Button
④	+	+ Button
⑤	-	- Button
⑥	▲	Up Button
⑦	▼	Down Button
⑧	MENU	Menu Button

<Front>



⑨	Power Indicator	Green	Lighting : Normal Operation Flash : When SCHEDULE is enabled.
		Orange	Signal Standby Mode
		Red	Power Off
⑩	Remote Sensor		Remote Sensor

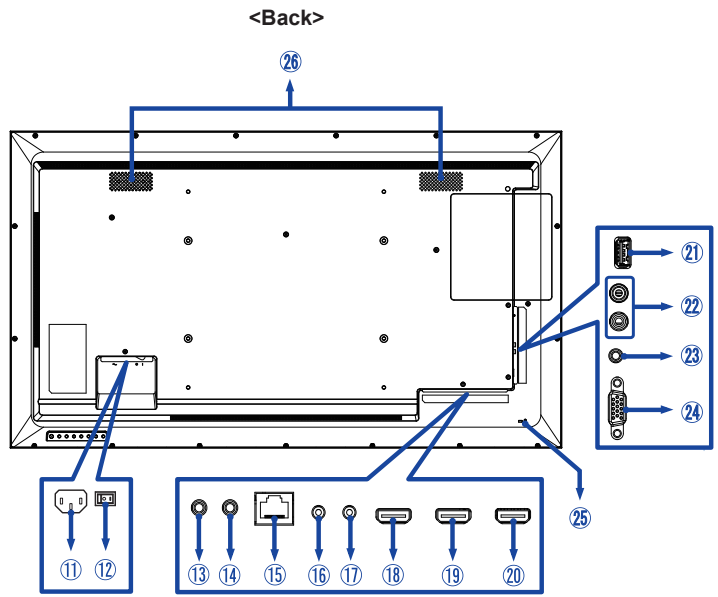

⑪	AC IN	AC-INLET	AC Connector(～: Alternating current) (AC-IN)
⑫	AC SWITCH I (ON) / O (OFF)	MAIN POWER	Main Power Switch
⑬	IR-IN	ø 3.5mm Mini Jack	IR Connector
⑭	IR-OUT	ø 3.5mm Mini Jack	IR Connector
⑮	LAN	RJ45	RJ45 Connector
⑯	RS232C IN	ø 2.5mm Sub-Mini Jack	RS232C Connector
⑰	RS232C OUT	ø 2.5mm Sub-Mini Jack	RS232C Connector
⑱	HDMI1	HDMI	HDMI Connector
⑲	HDMI2	HDMI	HDMI Connector
⑳	HDMI3	HDMI	HDMI Connector
㉑	USB	USB2.0 (5V, 500mA)	USB Connector
㉒	AUDIO OUT	ø 3.5mm Mini Jack	Audio output Connector
㉓	AUDIO IN	ø 3.5mm Mini Jack	Audio Connector
㉔	VGA IN	VGA	VGA Connector
㉕	Keyhole for Security Lock		
㉖	SPEAKERS		

INSTALLATION

CAUTION

- Follow the manual instructions for the type of mount you have selected. Refer all servicing to qualified service personnel.
- Moving the monitor requires at least two people.
- Before installing, please make sure the wall is strong enough to hold the necessary weight of the monitor and the mount.

[WALL MOUNTING]

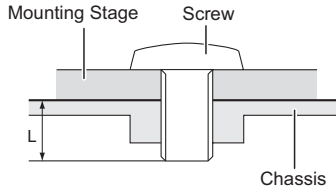

CAUTION

When using the wall mounting, consideration of thickness of the mounting stage needs to be taken. Tighten the M6 Screws (4pcs) which "L" length is 10mm to fasten the monitor. Using a screw longer than this may cause electric shock or damage because it may contact with the electrical parts inside the monitor.

[ROTATING THE MONITOR]

It is designed to be compatible in landscape mode.

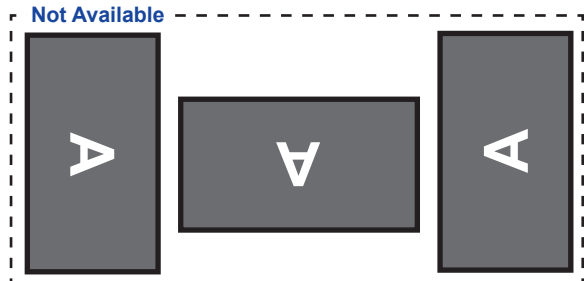
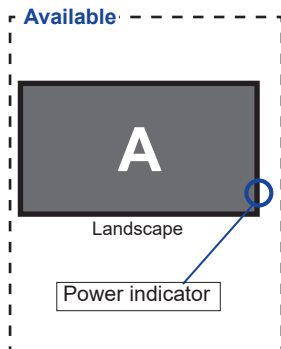

FUNCTIONS OF THE REMOTE CONTROL

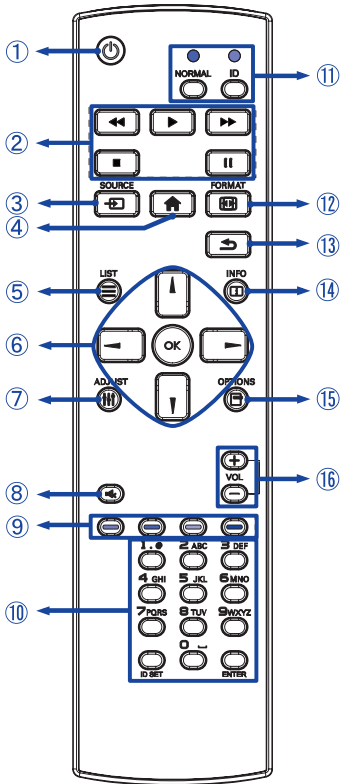

①		Turns the monitor ON and OFF.
②	[PLAY]	Control playback of media files. ▶ : Play ■ : Stop ⏸ : Pause ⏮ : Quick-Return ⏭ : Fast-Forward
③	SOURCE	Selects the source. Press ▲ or ▼ button to select from HDMI1, HDMI2, HDMI3, D-SUB or USB. Press [OK] button to confirm and exit.
④		Opens the monitor's on-screen menu systems.
⑤		Not available on this model.
⑥		Navigates through submenus and settings. ▲ : Up Button ▼ : Down Button ◀ : Left Button ▶ : Right Button
	OK	Confirms your selection or save changes.
⑦		Auto Adjust function only available when VGA input is selected.
⑧		Turns on or off the mute function when the Menu is not displayed.
⑨		Not available on this model.
⑩	NUMBER/ ID SET/ ENTER	Enter text for network setting or ID setting.
⑪	ID Mode	ID: To enter ID Mode NORMAL: To leave ID Mode
⑫		Change picture format.
⑬		Returns to a previous menu or closes the OSD Menu.
⑭		Provides source and resolution information. Not available for USB input.
⑮		Unlock the remote control. Press the buttons: OPTIONS → ▲ → ▼ → ◀ → ▶
⑯	VOLUME - / +	VOLUME - : Decreases the sound volume. VOLUME + : Increases the sound volume.

PREPARING THE REMOTE CONTROL

To use the remote control, insert the two dry batteries.

CAUTION

- Do not use any other batteries other than those specified in this manual for the Remote Control.
- Do not insert old and new batteries together in the Remote Control.
- Make sure that the terminals match the "+" and "-" indications in the battery compartment.
- Remove the dead batteries immediately to prevent them from liquid leaking into the battery compartment.
- Burst batteries or the electrolyte from these batteries may cause stains, fire or injury.

- ① Slide back and remove the battery cover in the direction of the arrow.

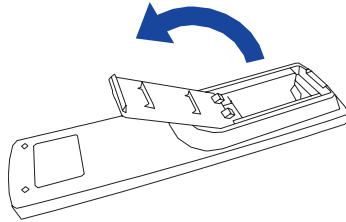

- ② Align and insert two AAA batteries according to their plus and minus ports (as indicated in the remote control).

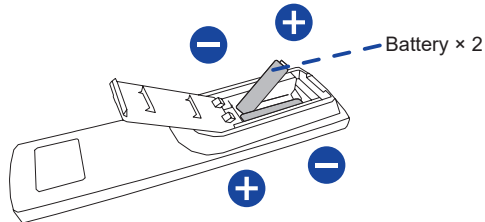

- ③ Replace the battery cover in the direction of the arrow and snap it back into place.

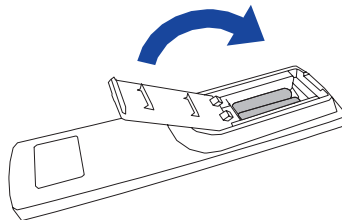

NOTE

- Refer to the above instructions when taking out the batteries.
- Replace with new batteries when the Remote Control does not work close to the monitor.
Use AAA dry batteries. Risk of explosion if battery is replaced by an incorrect type.
- Operate the Remote Control by pointing it toward the Remote Sensor on the monitor.
- Other manufacturers remote control will not work with this monitor. Use the provided Remote Control ONLY.
- Used batteries needed to follow the city rule to be discarded. (suggestion: to dispose of used batteries please follow correct policy as per your council regulations)
- Batteries shall not be exposed to excessive heat such as sunshine, fire or the like.
- If you do not intend to use the remote control for a long period, remove the batteries.

BASIC OPERATION

■ Turning the monitor ON

The monitor is turned On and the Power Indicator turns to Green when you press the POWER button on the monitor or the Remote Control. The monitor is turned Off and the Power Indicator turns to Red when you press the POWER button on the monitor or the Remote Control. Press again to turn On the monitor.

NOTE

Even when using the standby mode or turning OFF the Power Switch, the monitor will consume a small amount of electricity. Disconnect the Power Cable from the power supply whenever the monitor is not in use or during the night, to avoid unnecessary power consumption.

[Monitor]

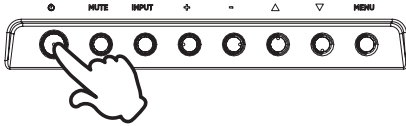

[Remote Control]

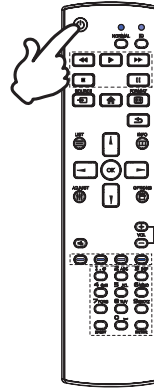

■ Display the adjustment menu page

The menu page appears on the screen when you press the MENU button on the monitor or the  HOME button on the Remote Control.

The menu page disappears when you press the  BACK button on the Remote Control again.

[Monitor]

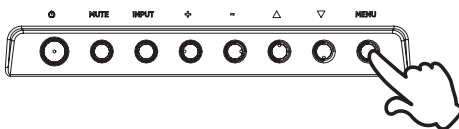

[Remote Control]

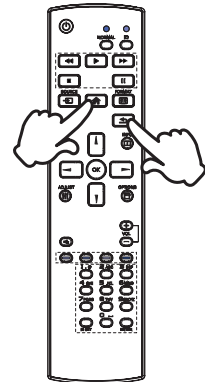

■ Move the cursor vertically

Select adjustment by pressing the ▲ / ▼ button on the monitor or the ▲ / ▼ button on the remote control while the menu page is displayed on the screen.

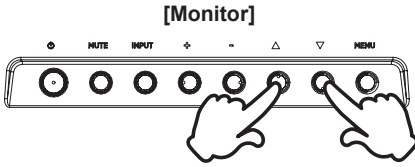

[Remote Control]

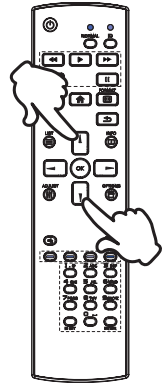

■ Move the cursor horizontally

Select menu or setting, or perform the adjustment by pressing the + / - button on the monitor or the ◀ / ▶ button on the remote control while the menu page is displayed on the screen.

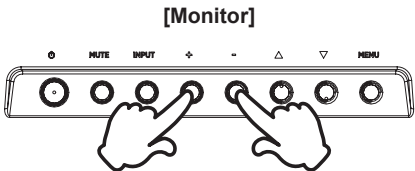

[Remote Control]

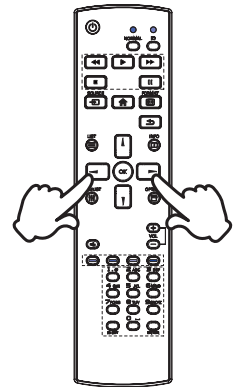

■ **Adjust the volume of sound**

Press the + / - button on the monitor or the remote control to adjust the volume of sound when the menu page is not displayed on the screen.

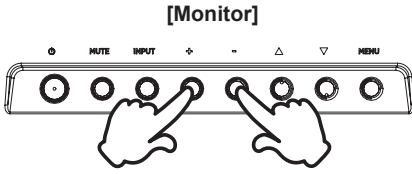

[Remote Control]

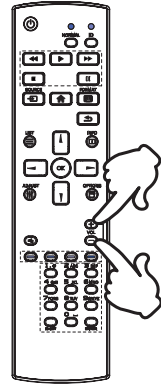

■ **Switch the input signal**

This is activated when you successively press the INPUT button on the monitor or the SOURCE button on the remote control.

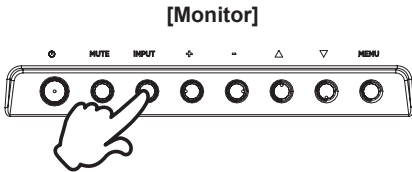

[Remote Control]

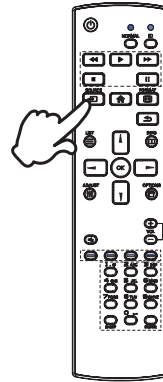

CONNECTING YOUR MONITOR

- ① Ensure that both the computer and the monitor are switched off.
- ② Connect the computer to the monitor with the signal cable.
- ③ Connect the computer with the RS-232C Cable from the monitor.
- ④ Connect the Power Cable to the monitor first and then to the power source.
- ⑤ Turn on your monitor (Main Power Switch and Power Switch) and computer.

NOTE

- Make sure that the building installation has a circuit breaker of 120/240V, 20A (maximum).
- The signal cables used for connecting the computer and monitor may vary with the type of computer used. An incorrect connection may cause serious damage to both the monitor and the computer. The cable supplied with the monitor is for a standard connector. If a special cable is required please contact your local iiyama dealer or regional iiyama office.
- Make sure you tighten the finger screws at each end of the Signal Cable.
- The Class I pluggable equipment Type A must be connected to protective earth.
- The socket-outlet shall be installed near the equipment and shall be easily accessible.
- Excessive sound pressure from ear-/headphones can cause hearing damage/hearing loss.

[Example of Connection]

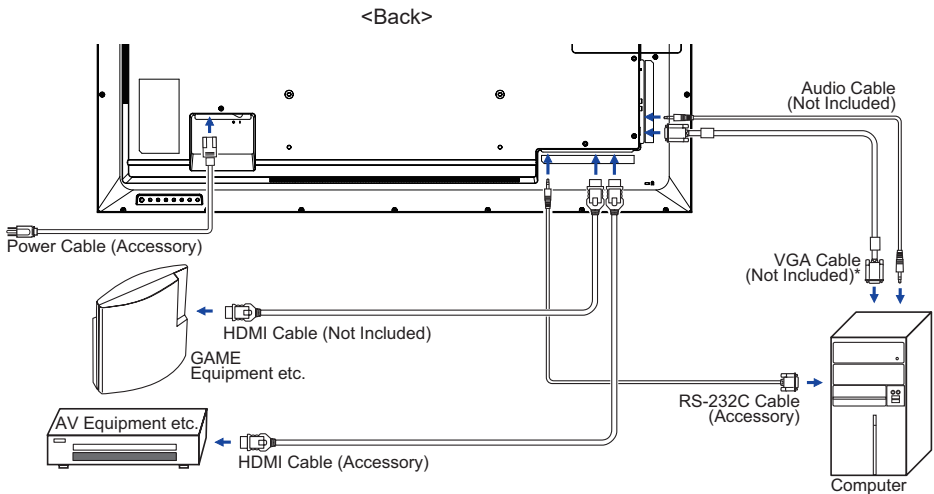

* VGA cable is not supplied with the monitor. If you use low quality VGA cable, it may cause a result of electro-magnetic interference. Please contact the iiyama Support Centre in your country if you wish to connect the monitor via the VGA input.

[Connection example with the peripheral device]

CAUTION

Turn off the power switch and unplug the monitor and peripherals before connection to avoid electric shock or damage.

NOTE

- Refer to the user manual of peripherals at the same time.
- Ensure you have the necessary cables as required.

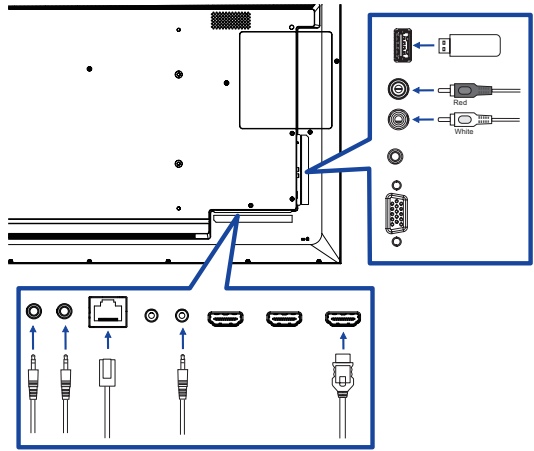

[To setup the network]

1. Switch on the router and switch on its DHCP setting.
2. Connect the router to this monitor with an Ethernet cable.
3. Select RS-232C/LAN SELECT = LAN in "GENERAL SETTINGS/COMMUNICATION SETTINGS"
4. NETWORK SETTING selectable.

NOTE Connecting with a shielded CAT-5 Ethernet cable to comply with the EMC directive.

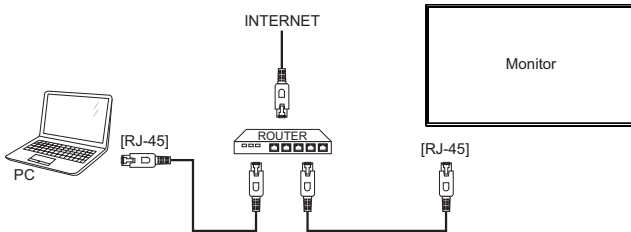

COMPUTER SETTING

- Signal Timing

Change to the desired signal timing listed on page 44: COMPLIANT TIMING.

OPERATING THE MONITOR

To create the best picture, your iiyama LCD monitor has been preset at the factory with the COMPLIANT TIMING shown on page 44. You are also able to adjust the picture by following the button operation shown below.

- ① Press the **HOME** button on the remote control or the **MENU** button on the Monitor to start the On Screen Display feature. There are additional Menu items which can be switched by using the **← / →** buttons on the remote control or the **+ / -** buttons on the monitor.

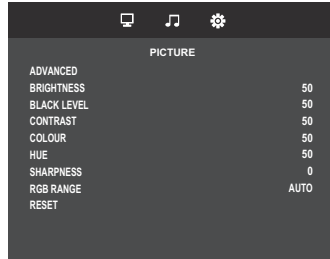

- ② Select the Menu item of the adjustment you want to make. Then, use the **▲ / ▼** buttons on the remote control or the **▲ / ▼** buttons on the monitor to highlight the desired adjustment item.
- ③ Use the **← / →** buttons on the remote control or the **+ / -** buttons on the monitor to make the appropriate adjustment or setting.
- ④ Press the **↶** BACK button on the remote control or the **MENU** button on the monitor to leave the menu, and the settings you just made would be automatically saved.

For example, to correct for sharpness, select Menu item of "Picture". Switched by using the **← / →** buttons on the remote control or the **+ / -** buttons on the monitor. Then, select "Sharpness" by using the **▲ / ▼** buttons on the remote control or the **▲ / ▼** buttons on the monitor.

Use the **← / →** buttons on the remote control or the **+ / -** buttons on the monitor to change the sharpness settings. The sharpness of the overall monitor should be changing accordingly while you are doing this.

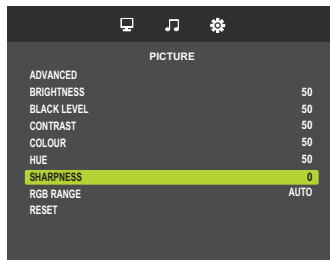



Press the **↶** BACK button on the remote control or the **MENU** button on the monitor lastly, it ends, all changes are saved in the memory.

NOTE

- The **↶** BACK button on the remote control can be used to return previous menu item.
- Any changes are automatically saved in the memory when the On Screen Display disappears. Turning off the power should be avoided while using the Menu.
- Adjustments for H. / V. Position, Clock and Phase are saved for each signal timing. Except for these adjustments, all other adjustments have only one setting which applies to all signal timings.

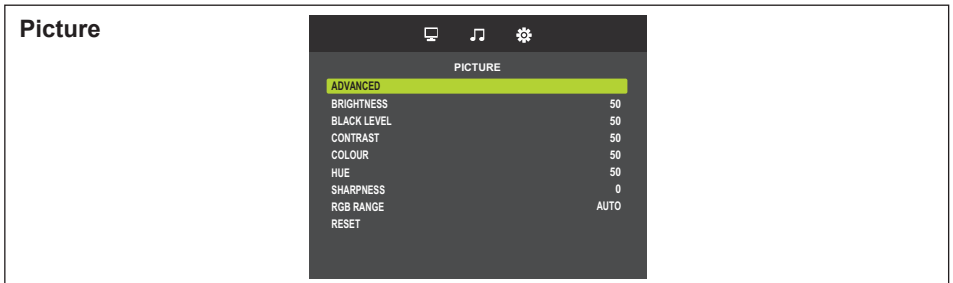
ADJUSTMENT MENU CONTENTS



Adjustment Item	Problem / Option		Button to Press	
Advanced	Picture format Direct	Wide	Shows widescreen format content stretched. Not recommended for HD or PC.	
		Zoom	Enlarges the image on the screen to the original screen ratio.	
		Normal	Display all pictures in the original resolution.	
		Dot by Dot	Display the picture dot by dot.	
	Color temp.	3000 K		
		4000 K		
		5000 K		
		6500 K		
		7500 K		
		9300 K		
		10000 K		
		User	Red	Too weak  Too strong 
		Green		
		Blue		
	Noise reduction *	Off	Noise Reduction is turned off.	
		LOW	Electronic image noise caused by different media players is reduced.	
		MIDDLE	Electronic image noise caused by different media players is reduced more than Low.	
		HIGH	Electronic image noise caused by different media players is reduced more than Mid.	
	Dynamic contrast *	On	Dynamically enhance the details areas of the picture.	
		Off	Dynamic contrast is turned off.	
Gamma	You can set the Gamma. 2.4 / 2.2 / 2.0 / 1.8			

* Only HDMI(Video) input.

Picture

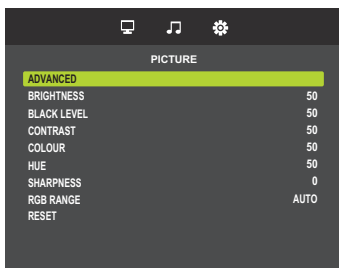

Adjustment Item	Problem / Option		Button to Press
Brightness* ¹	Too dark		
	Too bright		
Black level	Too dark		
	Too bright		
Contrast	Too dull		
	Too intense		
Colour * ²	Too weak		
	Too strong		
Hue * ²	Purplish		
	Greenish		
Sharpness * ²	Too soft		
	Too sharp		
RGB range * ²	Auto	Set color scale signal automatically.	
	Full range	For full-range color scale signal.	
	Limited range	For limited color scale signal.	
Reset	Yes	Picture setting will be restored to factory-preset data.	
	No	Return to Menu.	

*¹ Adjust the Brightness when you are using the monitor in a dark room and feel the screen is too bright.

*² Only HDMI(Video) input.

Sound

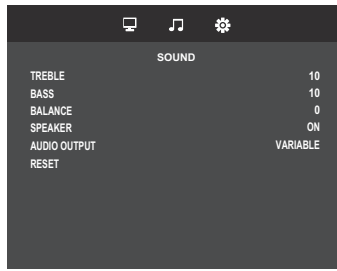

Adjustment Item	Problem / Option		Button to Press
Treble	Too weak		
	Too strong		
Bass	Too weak		
	Too strong		
Balance	Left side speaker is louder.		
	Right side speaker is louder.		
Speaker	Off	Turn Off the internal speaker.	
	On	Turn On the internal speaker.	
Audio output	Variable	Adjust the volume using VOLUME.	
	Fixed	Fixes the sounds.	
Reset	Yes	Sound setting will be restored to factory-preset data.	
	No	Return to Menu.	

General settings

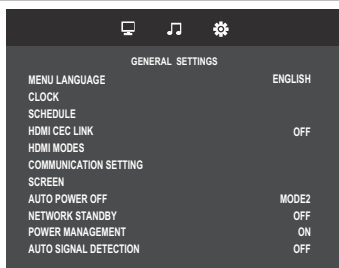

Adjustment Item	Problem / Option		Button to Press	
Menu Language	English	English	Nederlands	Dutch
	Français	French	Русский	Russian
	Italiano	Italian	Deutsch	German
	Español	Spanish	日本語	Japanese
Clock	Adjust the current date and time for the internal clock. NOTE You must set this item when using "Scheduling".			
Schedule	ON/OFF	On	Schedule is turned on.	
		Off	Schedule is turned off.	
	On Time	Set the time for the monitor to turn on.		
	Off Time	Set the time for the monitor to turn off.		
	Repeat modes	Sets a recurring schedule. Only once / Every SUN / Every MON / Every TUE / Every WED / Every THU / Every FRI / Every SAT		
Input	Select default input source to use when the monitor is automatically turned on next time. HDMI1/HDMI2/HDMI3/D-SUB/USB/AUTO PLAY1/AUTO PLAY2 *			
HDMI CEC link	OFF	Enable link according to HDMI CEC.		
	AUTO	Disable link according to HDMI CEC.		
HDMI modes	Not available on this model.			
Communication setting	RS-232C/	RS-232C		
	LAN select	LAN		

* The photo or video files in the USB flash drive can be automatically played using the Schedule setting.

General settings

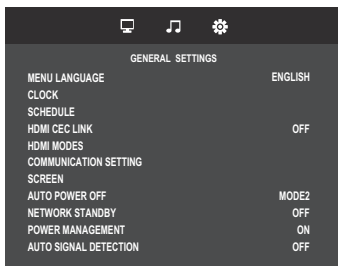

Adjustment Item	Problem / Option		Button to Press	
Communication setting	Network settings	View network settings	View connected network status.	
		DHCP client	Off	Return to Menu.
			On	Once you are connected, the IP.Address, Subnet mask, Default gateway, Primary DNS and Secondary DNS settings are displayed automatically.
		IP address	Assign IP adress for this monitor.	
		Subnet mask	Assign Subnet mask for this monitor.	
		Default gateway	Assign Default gateway for this monitor.	
Screen	Auto adjust* ^{1,3}		Adjust H. / V. Position, Clock and Phase automatically.	
	Clock* ^{1,2}	Too narrow		
		Too wide		
	Phase* ^{1,2}	To correct flickering text or lines		
	H Position* ¹	Too left		
		Too right		
	V Position* ¹	Too low		
Too high				
Reset	Yes	Screen setting will be restored to factory-preset data.		
	No	Return to Menu.		

*¹ Only VGA input.

*² See page 34 for SCREEN ADJUSTMENTS.

*³ For best results, use the Auto Adjust in conjunction with the adjustment pattern.
See page 34 for SCREEN ADJUSTMENTS.

General settings

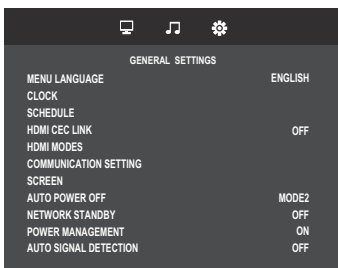

Adjustment Item	Problem / Option		Button to Press
Auto power off *	Set the time for this monitor to be switched off after a period of no activity. 180 mins		
	MODE1	AUTO POWER OFF will forcibly be fixed to "3h".	
		"Network Standby" will forcibly be set to "OFF".	
	MODE2	"Network Standby" can be set.	
	NOTE If the button operation is performed within the set time, the time count of the Auto Switch Off will be reset. The monitor will be turned off when the set time has elapsed.		
Network standby	Off	Network function is disable during Standby mode.	
	On	Network function is enable during Standby mode.	
Power management	Off	Power management is turned off.	
	On	Power management is turned on.	
Auto signal detection	Off	Disable the Auto signal detection.	
	On	Detects all sources automatically if there is no signal on the default input and selects the available signal automatically .	

* Only for EU direction.

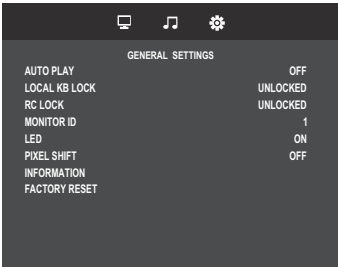
General Settings			
Adjustment Item	Problem / Option		Button to Press
Auto play* ¹	Off	Auto play is turned off.	
	Photo	Play photo file in the USB flash drive automatically.	
	Movie	Play video file in the USB flash drive automatically.	
Local KB lock	Choose to enable or disable the back controller function of this monitor.		
	Unlocked* ²	Enable the button function.	
	Lock all	Lock all the button function.	
RC lock	Choose to enable or disable the button function of the remote control.		
	Unlocked* ³	Enable the button function.	
	Lock all	Lock all the button function.	
	Lock except volume	Disable all the button function except the VOL+ and VOL- button.	
	Lock except power	Disable all the button function except the power button.	
Monitor ID	Set ID to the monitor. 1 - 255		
LED	Off	The Power Indicator is turned off.	
	On	The Power Indicator is turned on.	
NOTE Turn off the Power Indicator when you are bothered by the light.			
Pixel shift	Off	Pixel shift is turned off.	
	On	Move the position of the image at set intervals(10-900).	
	Auto	Move the position of the image automatically.	
Information	Show information about your monitor, including Model name, Serial No., Operation hours and SW version.		
Factory reset	Yes	Factory-preset data is restored.	
	No	Return to Menu.	

*1 Auto play by schedule works only if input is set to "USB" and "AUTO PLAY1" and "AUTO PLAY2".

Condition	By turning on the monitor	By inserting a media	By schedule
Location of target files	/autoplay,	/autoplay,	/autoplay, /autoplay1, /autoplay2
Playlist	Not need to make the file.	Not need to make the file.	Not need to make the file.
Supported file	jpg or mp4	jpg or mp4	jpg or mp4
Number of target files	Max 30 files	Max 30 files	Max 30 files
Audio files	Not supported	Not supported	Not supported
Combination with Photo and Movie	Not supported	Not supported	Not supported
Rule of target file name	ex.) "001.jpg", "002.jpg", 003.jpg"... "030.jpg"	ex.) "001.jpg", "002.jpg", 003.jpg"... "030.jpg"	ex.) "001.jpg", "002.jpg", 003.jpg"... "030.jpg"
Setting of AutoPlay	OFF/PHOTO/MOVIE	OFF/PHOTO/MOVIE	OFF/PHOTO/MOVIE
Repeat	Fixed All	Fixed All	Fixed All
Random	Invalid	Invalid	Invalid
Slideshow Time	Same as ManualPlay	Same as ManualPlay	Same as ManualPlay

*2 To unlock, press the +, +, - and - button on the monitor in this sequence, it will lock/unlock the control button function.

*3 To unlock, press the OPTIONS → ▲ → ▼ → ◀ → ▶ buttons on the remote control in this sequence.





[Play Multimedia Files]

You can play videos, photos, and music on your monitor from:









- A USB device connected to this monitor.

● Play multimedia files from USB device

This monitor can play music, movie, or photo files from your USB device.

1. Connect your USB device to the USB port on this display.
2. Press  SOURCE button, select USB, then press OK button.
3. The connected USB device is detected automatically for all its playable files which will be automatically sorted into 3 types:  Music,  Movie and  Photo.



4. Press the  BACK button to go up to the top layer in the screen. Press  or  button to select the file type. Press OK button to enter its play list.
5. Select the file you want. Press  button to start playing.
6. Follow the on-screen instruction to control the play option.
7. Press the PLAY buttons (, , , ) to control playing.

■ USB Standard:

2.0

■ Supported file system:

FAT16/32, NTFS

■ Supported file format:



- Music: MP3
- Movie: MP4, TS, MPG/MPEG
- Photo: JPEG

CAUTION

- The manufacturer is not responsible if the USB device is not supported, nor is it responsible for damage to or loss of data in the device.
- Do not overload the USB port. If you connect a USB storage device that consumes more than 500mA power, make sure that it is connected to its own external power supply.



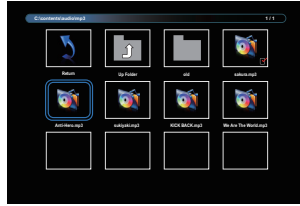

[Play options]

● Playing music files

1. Select  Music in the media type screen.
2. Select one music track, then press  button.







3. Press the  BACK button to display the play menu.

- Return : Return to select media type screen by pressing "OK" button.
- Up Folder : Go to the upper layer by pressing "OK" button.
- Focused item : Folder: If you press the "OK" button, you enter the folder.
File: Check mark is toggled by pressing "OK" button.
- Checked item : The item is in Playlist.
- Folder : Existing folder is displayed.
- Photo file : Supported extension file is displayed.
-  /  : The focus moves to the left or right item.
-  /  : Fast backward or forward playing the file.
-  : To stop the music.

■ Music options

Function	Content	Note
Play	Play the current file.	
Pause	Pause the playing file.	
FB	Fast backward playing the file.	FB2X, FB4X, FB8X, FB16X
FF	Fast forward playing the file.	FF2X, FF4X, FF8X, FF16X
Prev.	Go to the previous file.	
Next	Go to the next file.	
Stop	Stop the playing file and return to Photo browser.	
Repeat	RepeatNone: Play files in the playlist only once. Repeat1File: Play and repeat the current file. RepeatALL: Play and repeat files in the playlist.	
Repeat during A-B	Play and repeat set interval. SetA: Set the interval of the start point. SetB: Set the interval of the end point.	
Random Repeat	On: Play and repeat files of the playlist in random. Off: Play files of the playlist in order.	
Playlist	Show Playlist.	
Info.	Show Playing file information OSD.	

NOTE

To view information about a song (for example, title, artist or duration), select the song, press the  INFO button. To hide the information, press the  INFO button again. After pressing the  button to select a song, the menu screen disappears when the  INFO button is selected again. When press the OK button to display the menu screen.

●Playing movie files

1. Select  Movie in the media type screen.
2. Select a video, then press ► button.

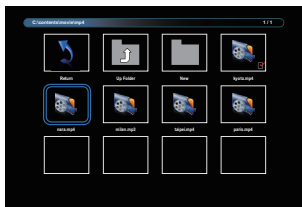



- Return : Return to select media type screen by pressing "OK" button.
- Up Folder : Go to the upper layer by pressing "OK" button.
- Focused item : Folder: If you press the "OK" button, you enter the folder.
File: Check mark is toggled by pressing "OK" button.
- Checked item : The item is in Playlist.
- Folder : Existed folder is displayed.
- Photo file : Supported extension file is displayed.
- ◀ / ▶ : The focus moves to the left or right item.
- ◀◀ / ▶▶ : Fast backward or forward playing the file.
- ■ : To stop the video.

■ Movie options

While playing video, press  INFO button.

Function	Content	Note
Play	Play the current file.	
Pause	Pause the playing file.	
FB	Fast backward playing the file.	FB2X, FB4X, FB8X, FB16X, FB32X
FF	Fast forward playing the file.	FF2X, FF4X, FF8X, FF16X, FF32X
Prev.	Go to the previous file.	
Next	Go to the next file.	
Stop	Stop the playing file and return to Photo browser.	
Repeat	RepeatNone: Play files in the playlist only once. Repeat1File: Play and repeat the current file. RepeatALL: Play and repeat files in the playlist.	Fixed to Repeat All with Auto Play.
Repeat during A-B	Play and repeat set interval. SetA: Set the interval of the start point. SetB: Set the interval of the end point.	Invalid with Auto Play.
Random Repeat	On: Play and repeat files of the playlist in random. Off: Play files of the playlist in order.	Invalid with Auto Play.
Playlist	Show Playlist.	
Info.	Show Playing file information OSD.	

● Playing photo files

1. Select  Photo in the media type screen.
2. Select a photo thumbnail, then press  button.

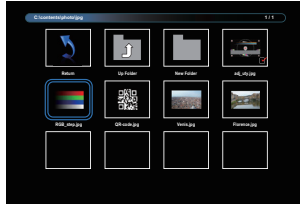

■ Start a slideshow

- Return : Return to select media type screen by pressing "OK" button.
- Up Folder : Go to the upper layer by pressing "OK" button.
- Focused item : Folder: If you press the "OK" button, you enter the folder.
File: Check mark is toggled by pressing "OK" button.
- Checked item : The item is in Playlist.
- Folder : Existed folder is displayed.
- Photo file : Supported extension file is displayed.
- ◀ / ▶ : The focus moves to the left or right photo.
- ■ : Stop the playing file and return to Photo browser.

■ Slideshow options

While you play a slideshow, press  INFO button.

Function	Content	Note
Play	Play the current file.	
Pause	Pause the playing file.	
Prev.	Go to the previous file.	
Next	Go to the next file.	
Stop	Stop the playing file and return to Photo browser.	
Repeat	RepeatNone: Play files in the playlist only once. Repeat1File: Play and repeat the current file. RepeatALL: Play and repeat files in the playlist.	Fixed to Repeat All with Auto Play.
Random Repeat	On: Play and repeat files of the playlist in random. Off: Play files of the playlist in order.	Invalid with Auto Play.
Music	Toggle Background music between "On" and "Off".	
Slideshow time	Select Slideshow time.	Selectable range: Short (5s), Medium (10s), Long (15s)
Playlist	Show Playlist.	
Info.	Show Playing file information OSD.	
Rotate 90 degrees Clockwise	Rotate the current file 90 degrees clockwise temporarily.	-When you execute this, slideshow is paused. -This operation effects only current file.
Rotate 90 degrees Anti-Clockwise	Rotate the current file 90 degrees Anti-clockwise temporarily.	-When you execute this, slideshow is paused. -This operation effects only current file
Zoom In	The file zooms in.	-Change to "Zoom 1/4", "Zoom 1/2", "Zoom1", "Zoom2", "Zoom4", "Zoom8" in order. -When execute this, slideshow is paused.
Zoom Out	The file zooms out.	-Change to "Zoom8", "Zoom4", "Zoom2", "Zoom1", "Zoom 1/2", "Zoom 1/4" in order. -When execute this, slideshow is paused.
Move View	Select view area in zoomed.	It is available with zoomed.

SCREEN ADJUSTMENTS

Adjust the image by following the procedure below to get the desired picture when selecting Analog input.

- The screen adjustments described in this manual are designed to set image position and minimize flicker or blur for the particular computer in use.
- The monitor is designed to provide the best performance at resolution of 3840 × 2160, but can not provide the best at resolutions of less than 3840 × 2160 because the picture is automatically stretched to fit the full screen. It is recommended to operate at resolution of 3840 × 2160 in normal use.
- Displayed text or lines will be blurred or irregular in thickness when the picture is stretched due to the screen enlargement process.
- It is preferable to adjust the image position and frequency with the monitor controls, rather than the computer software or utilities.
- Perform adjustments after a warm-up period of at least thirty minutes.
- Additional adjustments may be required after the Auto Adjust depending on the resolution or signal timing.
- The Auto Adjust may not work correctly when displaying the picture other than the screen adjustment pattern. In this case, manual adjustments are required.

There are two ways to adjust the screen. One way is automatic adjustment for Position, Clock and Phase. The other way is performing each adjustment manually.

Perform the Auto Adjust first when the monitor is connected to a new computer, or resolution is changed. If the screen has a flicker or blur, or the picture does not fit in the display area after performing the Auto Adjust, manual adjustments are required. Both adjustments should be made by using the screen adjustment pattern (Test.bmp) obtained via the IIYAMA web site (<https://iiyama.com>).

Adjust the image by following the procedure below to get the desired picture.

This manual explains adjustment under Windows® OS.

- ① **Display the picture at the optimum resolution.**
- ② **Enter the Test.bmp (screen adjustment pattern) to wallpaper.**

NOTE

- Consult the appropriate documentation for doing this.
- Set the display position to center in the wallpaper setting dialogue box.

[Adjustment pattern]

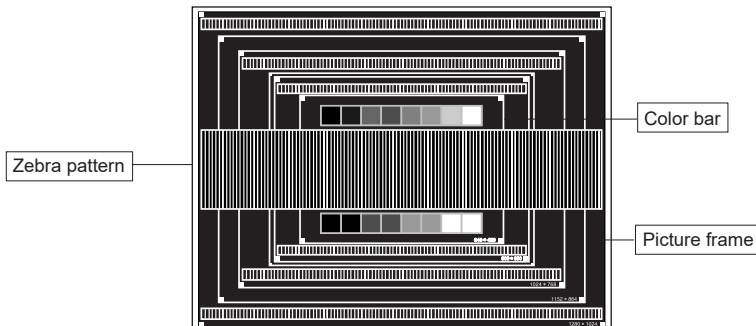

- ③ Adjust the Auto Adjustment. (Auto Adjust)
- ④ Adjust the image manually by following procedure below when the screen has a flicker or blur, or the picture does not fit in the display area after performing the Auto Adjust.
- ⑤ Adjust the V.Position so that the top and bottom of the picture frame will fit to the display area.

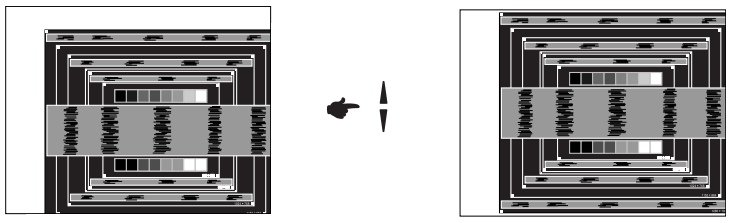

- ⑥ 1) Adjust the H.Position so that the left side of the picture frame will move to the left edge of the display area.

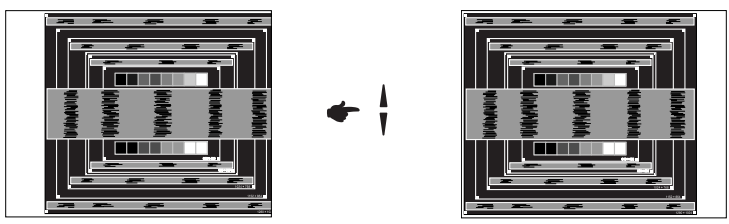

- 2) Stretch the right side of the picture frame to the right edge of the display area by adjusting the Clock.

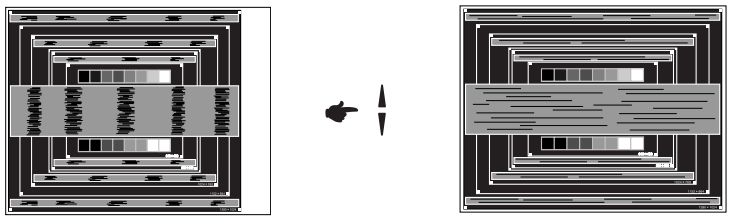

- NOTE**
- When the left side of the picture frame moves apart from the left edge of the display area during the Clock adjustment, adjust steps 1) and 2).
 - Another way to make the Clock adjustment is to correct the vertical wavy lines in the zebra pattern.
 - The picture may flicker during the Clock, H.Position and V.Position adjustment.
 - In case the picture frame is bigger or smaller than the data display area after the Pixel Clock adjustment, repeat steps from ③.

- ⑦ **Adjust the Phase to correct horizontal wavy noise, flicker or blur in the zebra pattern.**

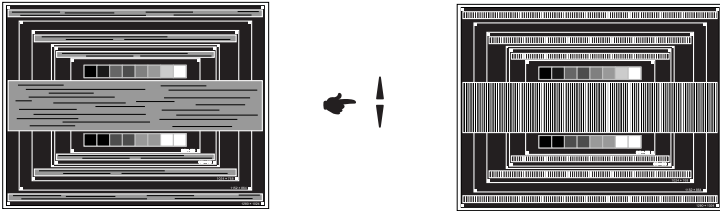

NOTE

- In case the strong flicker or blurs remain on a part of the screen, repeat steps ⑥ and ⑦ because the Clock may not be adjusted correctly.
- Adjust the H.Position after the Phase adjustment if the horizontal position moves during the adjustment.

- ⑧ **Adjust the Brightness and Color to get the desired picture after you complete the Clock and Phase adjustments.**

Put back your favorite wallpaper.

STANDBY FEATURE

This product features the standby function. When activated, it automatically reduces unnecessary power consumption of the monitor when your computer is not in use.

There is a standby step the monitor takes as described below. The standby function, including any timer settings is configured by the operating system. Check your operating system manual for information on how this can be configured.

■ Standby Mode

When the video signal from the computer is off, the monitor enters into Standby Mode which reduces the power consumption to less than 0.5W*. The screen becomes dark, and the power indicator turns to orange. From Standby Mode, the image reappears in several seconds when either the keyboard or the mouse are touched again.

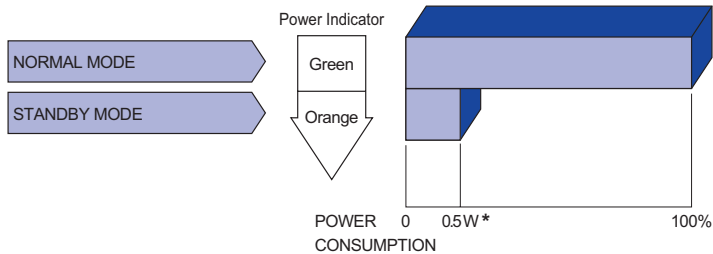

* When the USB devices are not connected.

TROUBLE SHOOTING

If the monitor fails to operate correctly, please follow the steps below for a possible solution.

1. Perform the adjustments described in OPERATING THE MONITOR, depending on the problem you have. If the monitor does not get a picture, skip to 2.
2. Consult the following items if you cannot find an appropriate adjustment item in OPERATING THE MONITOR or if the problem persists.
3. If you are experiencing a problem which is not described below or you cannot correct the problem, discontinue using the display and contact your dealer or iiyama service center for further assistance.

Problem

Check

- | | |
|---|---|
| ① The picture does not appear.
(Power indicator does not light up.)

(Power indicator is green.)

(Power indicator is orange.) | <input type="checkbox"/> The Power Cable is firmly seated in the socket.
<input type="checkbox"/> The Power Switch is turned ON.
<input type="checkbox"/> The AC socket is live. Please check with another piece of equipment.

<input type="checkbox"/> If the blank screen saver is in active mode, touch the keyboard or the mouse.
<input type="checkbox"/> Increase the Contrast and/or Brightness.
<input type="checkbox"/> The computer is ON.
<input type="checkbox"/> The Signal Cable is properly connected.
<input type="checkbox"/> The signal timing of the computer is within the specification of the monitor.

<input type="checkbox"/> If the monitor is in standby mode, touch the keyboard or the mouse.
<input type="checkbox"/> The computer is ON.
<input type="checkbox"/> The Signal Cable is properly connected.
<input type="checkbox"/> The signal timing of the computer is within the specification of the monitor. |
| ② The screen is not synchronized. | <input type="checkbox"/> The Signal Cable is properly connected.
<input type="checkbox"/> The signal timing of the computer is within the specification of the monitor. |
| ③ The screen position is not in the center. | <input type="checkbox"/> The signal timing of the computer is within the specification of the monitor. |
| ④ The screen is too bright or too dark. | <input type="checkbox"/> The video output level of the computer is within the specification of the monitor. |
| ⑤ The screen is shaking. | <input type="checkbox"/> The power voltage is within the specification of the monitor.
<input type="checkbox"/> The signal timing of the computer is within the specification of the monitor. |
| ⑥ No sound. | <input type="checkbox"/> The audio equipment (computer etc.) is ON.
<input type="checkbox"/> The Audio Cable is properly connected.
<input type="checkbox"/> The Volume is turned up.
<input type="checkbox"/> The Mute is OFF.
<input type="checkbox"/> The audio output level of the audio equipment is within the specification of the monitor. |
| ⑦ The sound is too loud or too quiet. | <input type="checkbox"/> The audio output level of the audio equipment is within the specification of the monitor. |
| ⑧ A strange noise is heard. | <input type="checkbox"/> The Audio Cable is properly connected. |

RECYCLING INFORMATION

For better environment protection please don't dispose your monitor.
Please visit our web site: <https://iiyama.com> for monitor recycling.

APPENDIX

Design and specifications are subject to change without prior notice.

SPECIFICATIONS : ProLite LE4341UHS-B1

ENGLISH

Size Category	43"	
LCD Panel	Panel technology	IPS
	Size	Diagonal: 42.5" (108cm)
	Pixel pitch	0.2451mm H × 0.2451mm V
	Brightness	350cd/m ² (Typical), 220cd/m ² (Default / Energy Saving)
	Contrast ratio	1200 : 1 (Typical)
	Viewable angle	Horizontal : 89 degrees, Vertical: 89 degrees (Typical)
	Response time	8ms (Typical, Gray to Gray)
Display Colors	Approx. 1.07G	
Sync Frequency	VGA: Horizontal: 30.0-80.0kHz, Vertical: 50-75Hz HDMI: Horizontal: 30.0-135.0kHz, Vertical: 50-75Hz	
Native Resolution	3840 × 2160, 8.3 MegaPixels	
Support Max. Resolution	VGA: 1920 × 1080 60Hz HDMI: 3840 × 2160 60Hz	
Input Connector	VGA, HDMI × 3	
Input Audio Connector	ø 3.5mm mini jack (Stereo)	
LAN	RJ45	
Serial Port	RS-232C In/Out ø 2.5mm sub-mini jack	
Input Sync Signal	Separate sync: TTL, Positive or Negative	
Input Video Signal	Analog: 0.7Vp-p (Standard), 75Ω, Positive Digital: HDMI	
Input Audio Signal	0.5Vrms maximum	
IR Extender Connector	IR In/Out	
USB Connector	USB2.0(DC5V, 500mA, USB Media Player)	
Speakers	Internal: 10W×2 (Stereo speakers)	
Maximum Screen Size	941.18mm W × 529.42mm H / 37.1" W × 20.8" H	
Power Source	100-240VAC, 50-60Hz, 2.0A	
Power Consumption*	117W typical, Standby mode: 0.5W maximum, Off mode: 0.3W maximum	
Dimensions / Net Weight	972.0 × 560.0 × 67.5mm / 38.3 × 22.0 × 2.7" (W×H×D) 8.8kg / 19.4lbs	
Environmental Considerations	Operating:	Temperature 0 to 40°C / 32 to 104°F Humidity 20 to 80% (No condensation)
	Storage:	Temperature -20 to 60°C / 4 to 140°F Humidity 5 to 95% (No condensation)
Approvals	CE, UKCA, EAC, TÜV-Bauart	

NOTE * When the USB devices are not connected.

SPECIFICATIONS : ProLite LE5041UHS-B1

Size Category	50"	
LCD Panel	Panel technology	VA
	Size	Diagonal: 49.5" (125.7cm)
	Pixel pitch	0.285375mm H × 0.285375mm V
	Brightness	350cd/m ² (Typical), 230cd/m ² (Default / Energy Saving)
	Contrast ratio	5000 : 1 (Typical)
	Viewable angle	Horizontal : 89 degrees, Vertical: 89 degrees (Typical)
	Response time	6ms (Typical, Gray to Gray)
Display Colors	Approx.1.07G	
Sync Frequency	VGA: Horizontal: 30.0-80.0kHz, Vertical: 50-75Hz HDMI: Horizontal: 30.0-135.0kHz, Vertical: 50-75Hz	
Native Resolution	3840 × 2160, 8.3 MegaPixels	
Support Max. Resolution	VGA: 1920 × 1080 60Hz HDMI: 3840 × 2160 60Hz	
Input Connector	VGA, HDMI × 3	
Input Audio Connector	ø 3.5mm mini jack (Stereo)	
LAN	RJ45	
Serial Port	RS-232C In/Out ø 2.5mm sub-mini jack	
Input Sync Signal	Separate sync: TTL, Positive or Negative	
Input Video Signal	Analog: 0.7Vp-p (Standard), 75Ω, Positive Digital: HDMI	
Input Audio Signal	0.5Vrms maximum	
IR Extender Connector	IR In/Out	
USB Connector	USB2.0(DC5V, 500mA, USB Media Player)	
Speakers	Internal: 10W×2 (Stereo speakers)	
Maximum Screen Size	1095.84mm W × 616.41mm H / 43.1" W × 24.3" H	
Power Source	100-240VAC, 50-60Hz, 2.2A	
Power Consumption*	112W typical, Standby mode: 0.5W maximum, Off mode: 0.3W maximum	
Dimensions / Net Weight	1127.5 × 648.0 × 72.5mm / 44.4 × 25.5 × 2.9" (W×H×D) 13.2kg / 29.1lbs	
Environmental Considerations	Operating: Temperature 0 to 40°C / 32 to 104°F Humidity 20 to 80% (No condensation) Storage: Temperature -20 to 60°C / 4 to 140°F Humidity 5 to 95% (No condensation)	
Approvals	CE, UKCA, EAC, TÜV-Bauart	

NOTE * When the USB devices are not connected.

SPECIFICATIONS : ProLite LE5541UHS-B1

Size Category		55"
LCD Panel	Panel technology	IPS
	Size	Diagonal: 54.6" (138.8cm)
	Pixel pitch	0.315mm H × 0.315mm V
	Brightness	350cd/m ² (Typical), 220cd/m ² (Default / Energy Saving)
	Contrast ratio	1200 : 1 (Typical)
	Viewable angle	Horizontal : 89 degrees, Vertical: 89 degrees (Typical)
	Response time	8ms (Typical, Gray to Gray)
Display Colors		Approx.1.07G
Sync Frequency		VGA: Horizontal: 30.0-80.0kHz, Vertical: 50-75Hz HDMI: Horizontal: 30.0-135.0kHz, Vertical: 50-75Hz
Native Resolution		3840 × 2160, 8.3 MegaPixels
Support Max. Resolution		VGA: 1920 × 1080 60Hz HDMI: 3840 × 2160 60Hz
Input Connector		VGA, HDMI × 3
Input Audio Connector		ø 3.5mm mini jack (Stereo)
LAN		RJ45
Serial Port		RS-232C In/Out ø 2.5mm sub-mini jack
Input Sync Signal		Separate sync: TTL, Positive or Negative
Input Video Signal		Analog: 0.7Vp-p (Standard), 75Ω, Positive Digital: HDMI
Input Audio Signal		0.5Vrms maximum
IR Extender Connector		IR In/Out
USB Connector		USB2.0(DC5V, 500mA, USB Media Player)
Speakers		Internal: 10W×2 (Stereo speakers)
Maximum Screen Size		1209.6mm W × 680.4mm H / 47.6" W × 26.8" H
Power Source		100-240VAC, 50-60Hz, 2.2A
Power Consumption*		129W typical, Standby mode: 0.5W maximum, Off mode: 0.3W maximum
Dimensions / Net Weight		1240.5 × 711.5 × 69.0mm / 48.8 × 28.0 × 2.7" (W×H×D) 14.7kg / 32.4lbs
Environmental Considerations		Operating: Temperature 0 to 40°C / 32 to 104°F Humidity 20 to 80% (No condensation) Storage: Temperature -20 to 60°C / 4 to 140°F Humidity 5 to 95% (No condensation)
Approvals		CE, UKCA, EAC, TÜV-Bauart

NOTE * When the USB devices are not connected.

DIMENSIONS : ProLite LE4341UHS

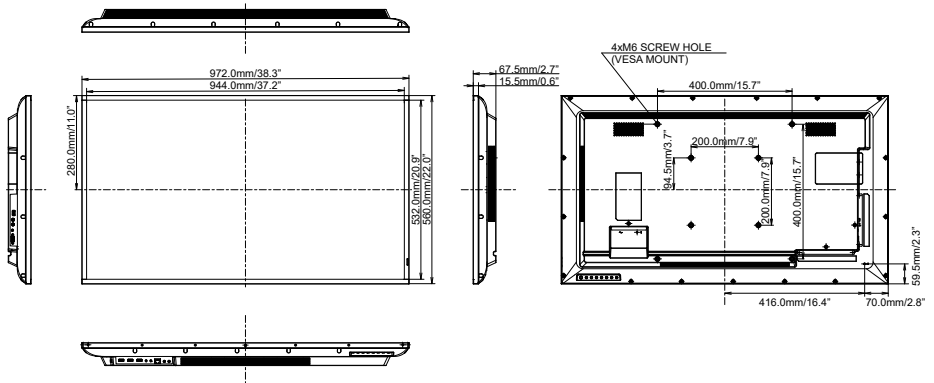

ENGLISH

DIMENSIONS : ProLite LE5041UHS

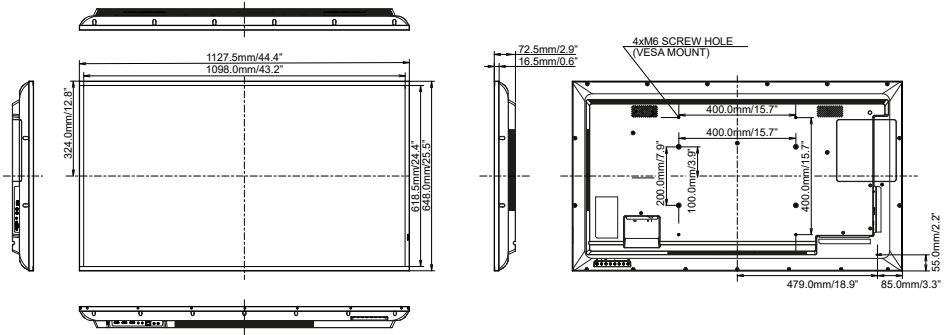

DIMENSIONS : ProLite LE5541UHS

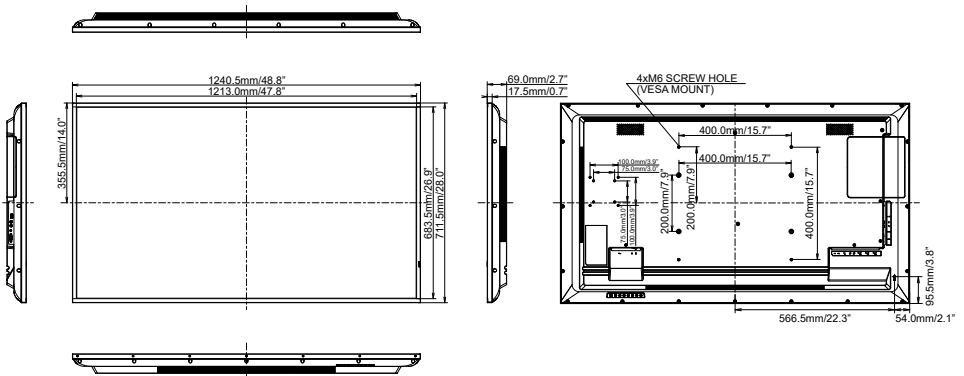

COMPLIANT TIMING

Timing		fH(kHz)	fV(Hz)	Dot clock (MHz)	VGA(via DVI)	HDMI1	HDMI2	HDMI3
VESA	VGA 640x480	31.5	60.0	25.175	○	○	○	○
	SVGA 800x600	37.9	60.0	40.000	○	○	○	○
	XGA 1024x768	48.4	60.0	65.000	○	○	○	○
	WXGA 1280x768	47.8	60.0	79.500	○	○	○	○
	QVGA 1280x960	60.0	60.0	108.000	○	○	○	○
	SXGA 1280x1024	64.0	60.0	108.000	○	○	○	○
	HD FWXGA 1366x768	47.7	60.0	85.500	○	○	○	○
	CVT 1400x900	55.9	60.0	106.500	○	○	○	○
	WSXGA 1680x1050	65.3	60.0	146.250	○	○	○	○
	FHD 1920x1080	67.5	60.0	148.500	○	○	○	○
	4K 3840x2160	67.5	30.0	297.000		○	○	○
135.0		60.0	594.000		○	○	○	
IBM	720x400	31.5	70.0	28.320	○	○	○	
SD	480i	60Hz	15.7	60.0	13.500		○	○
	576i	50Hz	15.6	50.0	13.500		○	○
	480p	60Hz	31.5	60.0	27.000		○	○
	576p	50Hz	31.3	50.0	27.000		○	○
HD	720p	50Hz	37.5	50.0	74.250		○	○
		60Hz	45.0	60.0	74.250		○	○
	1080i	50Hz	28.1	50.0	74.250		○	○
		60Hz	33.8	60.0	74.250		○	○
	1080p	50Hz	56.3	50.0	148.500		○	○
		60Hz	67.5	60.0	148.500		○	○

* ○ means supported the timing.