

# USER MANUAL

# ***G-MASTER***

## **LCD Monitor**

ENGLISH

### ***G-MASTER GB2770QSU***

Thank you very much for choosing the iiyama LCD monitor.

We recommend that you take a few minutes to read this comprehensive manual carefully before installing and switching on the monitor. Please keep this manual in a safe place for your future reference.



**Dear user, we congratulate you on the purchase of your iiyama LCD.**

For details on warranty and locally used pixel policies that apply directly after installation of your product please check the iiyama website.

**To report a fault, please contact your local support centre found at <https://iiyama.com>**

**Things to check before you call the iiyama information line**

- | if the power cable is connected securely and turned on?
- | if the display has been turned on?
- | if the signal cable is connected securely and the correct input selected?
- | if the computer has been restarted with the display connected?
- | if the graphics card is correctly installed with the latest drivers possible?
- | if the correct native resolution has been selected via 'Display Properties'?
- | If the R/G/B signal configuration is correct?
- | if the displays On Screen Menu is shown?
- | if the correct brightness and contrast settings have been set?
- | if given display tolerances and compatibility have been considered?
- | if via the On Screen Menu you have performed a Factory Reset/Recall?



**Before reporting the screen defect, please prepare the following information/evidence:**

- | model number \*
- | purchase receipt and serial number \*
- | name and address for collection
- | telephone/fax number, for availability during the day
- | convenient collection date (date, time)
- | short description of the defect

**Important Note:**

If there is no fault found in the collected equipment after inspection, the transferring party shall incur charges for transport and administration.

If you have checked all of the above and there is still no picture, call our information line for assistance in your country.

\* see the identification plate on the back of the case.

## CE MARKING DECLARATION OF CONFORMITY

This LCD monitor complies with the requirements of the EC/EU Directive 2014/30/EU "EMC Directive", 2014/35/EU "Low Voltage Directive", 2009/125/EC "ErP Directive" and 2011/65/EU "RoHS Directive".

The electro-magnetic susceptibility has been chosen at a level that gives correct operation in residential areas, business and light industrial premises and small-scale enterprises, inside as well as outside of the buildings. All places of operation are characterised by their connection to the public low voltage power supply system.

IYAMA CORPORATION: Wijkmeerstraat 8, 2131 HA Hoofddorp, The Netherlands

Model No. : PL2770QS



We recommend recycling of used product. Please contact your dealer or iiyama service center. Recycle information is obtained via the Internet, using the address: <https://iiyama.com>

You can access the Web page of different countries from there.

- We reserve the right to change specifications without notice.
- All trademarks used in this user manual are the property of their respective owners.
- The terms HDMI and HDMI High-Definition Multimedia Interface, and the HDMI Logo are trademarks or registered trademarks of HDMI Licensing Administrator, Inc. in the United States and other countries.
- The font used in the OSD menu is licensed under the Apache License, Version 2.0. You may obtain a copy of the License at <http://www.apache.org/licenses/LICENSE-2.0>
- Eprel registration number G-MASTER GB2770QSU-B5 : 1435324

# TABLE OF CONTENTS

FOR YOUR SAFETY.....	1
SAFETY PRECAUTIONS.....	1
SPECIAL NOTES ON LCD MONITORS.....	3
CUSTOMER SERVICE.....	3
CLEANING.....	3
BEFORE YOU OPERATE THE MONITOR.....	4
FEATURES.....	4
CHECKING THE CONTENTS OF THE PACKAGE.....	4
USING ARM OR STAND.....	5
FITTING AND REMOVAL OF STAND.....	7
CONTROLS AND CONNECTORS.....	9
CONNECTING YOUR MONITOR.....	10
COMPUTER SETTING.....	11
ADJUSTING THE HEIGHT AND THE VIEWING ANGLE.....	11
OPERATING THE MONITOR.....	12
ADJUSTMENT MENU CONTENTS.....	13
STANDBY FEATURE.....	25
TROUBLE SHOOTING.....	26
RECYCLING INFORMATION.....	27
APPENDIX.....	28
SPECIFICATIONS : G-MASTER GB2770QSU-B5.....	28
DIMENSIONS.....	29
COMPLIANT TIMING.....	30

# FOR YOUR SAFETY

## SAFETY PRECAUTIONS

### WARNING

#### **STOP OPERATING THE MONITOR WHEN YOU SENSE TROUBLE**

If you notice any abnormal phenomena such as smoke, strange sounds or fumes, unplug the monitor and contact your dealer or iiyama service center immediately. Further use may be dangerous and can cause fire or electric shock.

#### **NEVER REMOVE THE CABINET**

High voltage circuits are inside the monitor. Removing the cabinet may expose you to the danger of fire or electric shock.

#### **DO NOT PUT ANY OBJECT INTO THE MONITOR**

Do not put any solid objects or liquids such as water into the monitor. In case of an accident, unplug your monitor immediately and contact your dealer or iiyama service center. Using the monitor with any object inside may cause fire, electric shock or damage.

#### **INSTALL THE MONITOR ON A FLAT, STABLE SURFACE**

The monitor may cause an injury if it falls or is dropped.

#### **DO NOT USE THE MONITOR NEAR WATER**

Do not use where water may be splashed or spilt onto the monitor as it may cause fire or electric shock.

#### **OPERATE UNDER THE SPECIFIED POWER SUPPLY**

Be sure to operate the monitor only with the specified power supply. Use of an incorrect voltage will cause malfunction and may cause fire or electric shock.

#### **PROTECT THE CABLES**

Do not pull or bend the power cable and signal cable. Do not place the monitor or any other heavy objects on the cables. If damaged, the cables may cause fire or electric shock.

#### **ADVERSE WEATHER CONDITIONS**

It is advisable not to operate the monitor during a heavy thunder storm as the continual breaks in power may cause malfunction. It is also advised not to touch the plug in these circumstances as it may cause electric shock.

## CAUTION

### INSTALLATION LOCATION

Do not install the monitor where sudden temperature changes may occur, or in humid, dusty or smoky areas as it may cause fire, electric shock or damage. You should also avoid areas where the sun shines directly on the monitor.

### DO NOT PLACE THE MONITOR IN A HAZARDOUS POSITION

The monitor may topple and cause injury if not suitably located. Please also ensure that you do not place any heavy objects on the monitor, and that all cables are routed such that children may not pull the cables and possibly cause injury.

### MAINTAIN GOOD VENTILATION

Ventilation slots are provided to keep the monitor from overheating. Covering the slots may cause fire. To allow adequate air circulation, place the monitor at least 10cm (or 4 inches) from any walls. When removing the tilt stand, the ventilation slots on the back side of the monitor can be blocked. This may overheat the monitor and may cause fire or damage. Make sure to allow enough ventilation when removing the tilt stand. Operating the monitor on its back, side, upside down or on a carpet or any other soft material may also cause damage.

### DISCONNECT THE CABLES WHEN YOU MOVE THE MONITOR

When you move the monitor, turn off the power switch, unplug the monitor and be sure the signal cable is disconnected. If you do not disconnect them, it may cause fire or electric shock.

### UNPLUG THE MONITOR

If the monitor is not in use for a long period of time it is recommended that it is left unplugged to avoid accidents.

### HOLD THE PLUG WHEN DISCONNECTING

To disconnect the power cable or signal cable, always pull it by the plug. Never pull on the cable itself as this may cause fire or electric shock.

### DO NOT TOUCH THE PLUG WITH WET HANDS

Pulling or inserting the plug with wet hands may cause electric shock.

### WHEN YOU INSTALL THE MONITOR ON YOUR COMPUTER

Be sure the computer is strong enough to hold the weight of the monitor, otherwise, you may damage your computer.

### CAREFUL! PROTECT YOUR HANDS AND FINGERS

- Be careful not to hurt your fingers or hands when you change the height or the angle.
- Injury can occur if care is not taken to avoid finger contact with the displays base when adjusting the height.

### REMARK FOR 24/7 USAGE

This product is not specifically designed for 24/7 usage in all environments.

### REMARK FOR WALL MOUNTING

This product is not designed for digital signage (electronic signboard) applications such as wall mounting.

## OTHERS

### ERGONOMIC RECOMMENDATIONS

To eliminate eye fatigue, do not operate the monitor against a bright background or in a dark room. For optimal viewing comfort, the monitor should be just below eye level and 40-60 cm (16-24 inches) away from your eyes. When using the monitor over a prolonged time, a ten minute break every hour is recommended as looking at the screen continuously can cause eye strain.

## SPECIAL NOTES ON LCD MONITORS

The following symptoms are normal with LCD monitors and do not indicate a problem.

### NOTE

- When you first turn on the LCD monitor, the picture may not fit in the display area because of the type of computer that is used. In this case, adjust the picture position to the correct position.
- You may find slightly uneven brightness on the screen depending on the desktop pattern you use.
- Due to the nature of the LCD screen, an afterimage of the previous screen may remain after switching the image, when the same image is displayed for hours. In this case, the screen can be recovered slowly by changing the image or turning off the Power Switch for some hours.

## CUSTOMER SERVICE

### NOTE

- If you have to return your unit for service and the original packaging has been discarded, please contact your dealer or iiyama service center for advice or replacement packaging.

## CLEANING

### WARNING

- If you drop any materials or liquids such as water into the monitor when cleaning, unplug the power cable immediately and contact your dealer or iiyama service center.

### CAUTION

- For safety reasons, turn off the power switch and unplug the monitor before you clean it.

### NOTE

- To protect the LCD panel, do not scratch or rub the screen with a hard object.
- Never use any of the following strong solvents. These will damage the cabinet and the LCD screen.

Thinner	Spray-type cleaner
Benzine	Wax
Abrasive cleaner	Acid or Alkaline solvent

- Touching the cabinet with any product made from rubber or plastic for a long time may cause degeneration or loss of paint on the cabinet.

### CABINET

Stains can be removed with a cloth lightly moistened with a mild detergent solvent. Then wipe the cabinet with a soft dry cloth.

### LCD SCREEN

Periodic cleaning with a soft dry cloth is recommended.

Don't use tissue paper etc. because these will damage the LCD screen.

# BEFORE YOU OPERATE THE MONITOR

## FEATURES

- ◆ Supports Resolutions up to 2560 × 1440
- ◆ High Contrast 1000:1 (Typical), Adv. Contrast Function Available / Brightness 400cd/m<sup>2</sup> (Typical)
- ◆ Supports AMD FreeSync™ Premium Pro
- ◆ Supports HDR400
- ◆ Flicker - Free
- ◆ Moving Picture Response Time 0.5ms
- ◆ Blue Light Reducer
- ◆ Digital Character Smoothing
- ◆ 2 × 2W Stereo Speakers
- ◆ Standby Feature
- ◆ VESA Mounting Standard (100mm×100mm) Compliant
- ◆ Keyhole for Security Lock

## CHECKING THE CONTENTS OF THE PACKAGE

The following accessories are included in your package. Check to see if they are enclosed with the monitor. If anything is missing or damaged, please contact your local iiyama dealer or regional iiyama office.

- |                 |                |                           |
|-----------------|----------------|---------------------------|
| ■ Power Cable * | ■ HDMI Cable   | ■ DisplayPort Cable       |
| ■ USB Cable     | ■ Stand-Neck   | ■ Stand-Base with a screw |
| ■ Screwdriver   | ■ Safety Guide | ■ Quick Start Guide       |

### CAUTION

- \* The rating of the Power Cable enclosed in 120V area is 10A/125V. If you are using a power supply higher than this rating, then a power cable with a rating of 10A/250V must be used. However, all guarantees and warranties are void for any problems or damage caused by a power cable not supplied by iiyama. An approved power cable greater or equal to H05VVf, 3G, 0.75mm<sup>2</sup> must be used.



## USING ARM OR STAND

### CAUTION

- Before installing, please make sure the wall or desktop arm is strong enough to hold the necessary weight of the display and the mount.
- Angle adjustment range : 23° upward and 5° downward

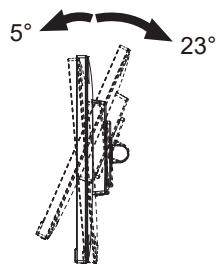

## < DISPLAY ARM OR DESK ARM STAND >

### CAUTION

When you use with the display arm or desk arm stand, in consideration of thickness of the mounting stage, tighten the M4 Screws (4pcs) which "L" length is 7mm to fasten the monitor. Using the screw longer than this may cause electric shock or damage because it may contact with the electrical parts inside the monitor.

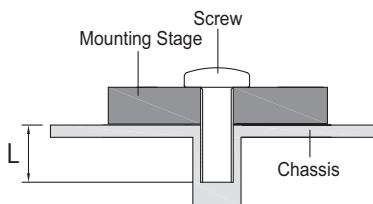

## < ROTATING THE DISPLAY >

The monitor is designed to be compatible with both landscape and portrait modes.  
Video card for portrait display will be required for rotating the image on the screen.

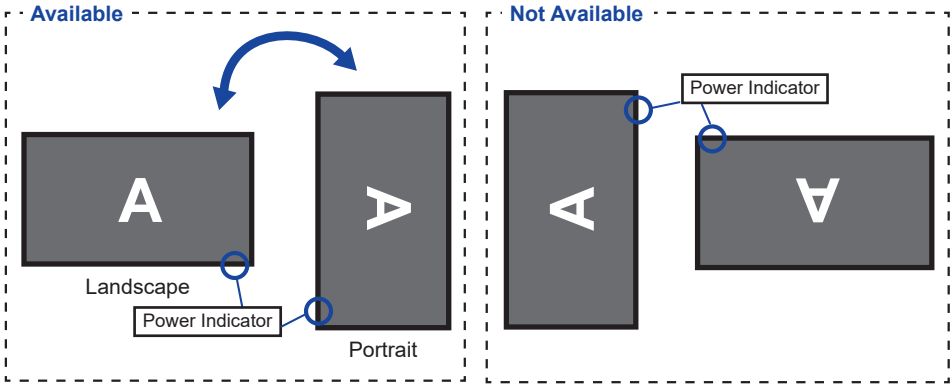

### With Stand:

#### NOTE

- Adjust the monitor's height before panel rotation.
- Attempting to rotate the panel forcibly without adjusting the stand height may cause damage to the panel or the stand.

## FITTING AND REMOVAL OF STAND

### CAUTION

- Put the monitor on a stable surface. The monitor may cause injury or damage if it falls or is dropped.
- Do not give a strong impact to the monitor. It may cause damage.
- Unplug the monitor before removal or installation to avoid an electric shock or a damage.

### <Installation>

- ① Put a piece of soft cloth on the table beforehand to prevent the monitor from being scratched. Lay the monitor flat on a table with front face down.
- ② Install the Stand-Neck to the monitor and then tighten the 'thumb screw' with the provided screwdriver to secure them.

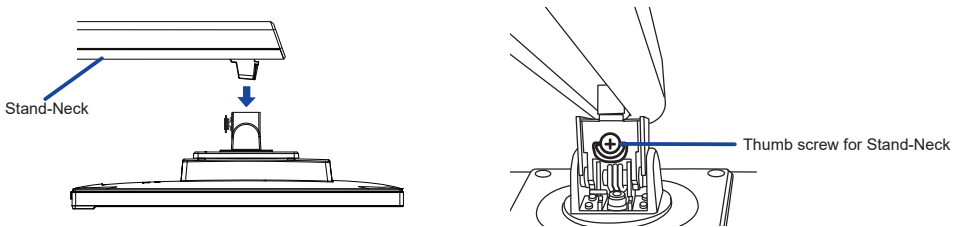

- ③ Install the Stand-Base to the Stand-Neck and then tighten the 'thumb screw' with the provided screwdriver to secure them.

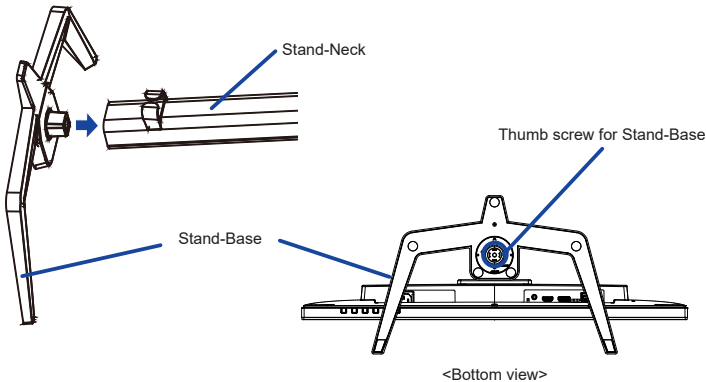

### <Removal>

- ① Put a piece of soft cloth on the table beforehand to prevent the monitor from being scratched. Lay the monitor flat on a table with front face down.
- ② Loosen the 'thumb screw' with the provided screwdriver to remove the Stand-Base from the Stand-Neck.
- ③ Loosen the 'thumb screw' with the provided screwdriver to remove the Stand-Neck from the monitor.

## CONTROLS AND CONNECTORS

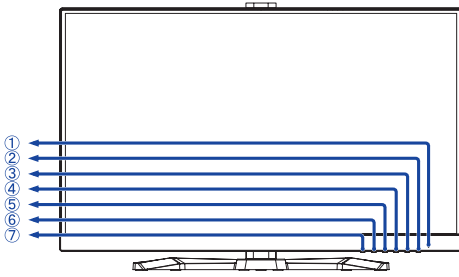



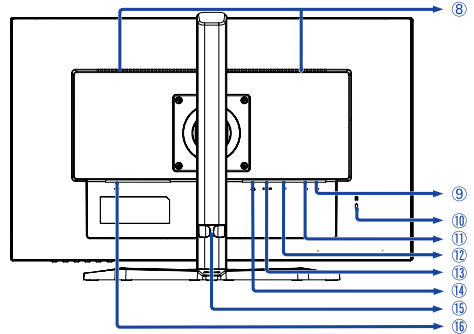



<Front>



<Back>

- ① Power Indicator

**NOTE** Blue: Normal operation  
Orange: Standby mode

- ② Power Switch (  )
- ③ Menu / Select Button (ENTER)
- ④ Scroll Up / Volume Button (  /  )
- ⑤ Scroll Down / ECO Mode Button (  /  )
- ⑥ Exit Button (EXIT)
- ⑦ Input Select Button (INPUT)
- ⑧ Speakers
- ⑨ USB Downstream Connector (  5V, 900mA)
- ⑩ Keyhole for Security Lock
- NOTE** You can fasten a security lock and cable to prevent the monitor from being removed without your permission.
- ⑪ USB Upstream Connector (  )
- ⑫ DisplayPort Connector (DP)
- ⑬ HDMI Connector (HDMI)
- ⑭ Headphone Connector (LINE OUT)
- ⑮ Cable Holder
- ⑯ AC Connector (  $\sim$  : Alternating current ) (  $\sim$  )

## CONNECTING YOUR MONITOR

- ① Ensure that both the computer and the monitor are switched off.
- ② Connect the computer to the monitor with the signal cable.
- ③ Connect the computer to the monitor with the USB Cable.
- ④ Connect the Power Cable to the monitor first and then to the power source.
- ⑤ Turn on your monitor and computer.

### NOTE

- Make sure that the building installation has a circuit breaker of 120/240V, 20A (maximum).
- The signal cables used for connecting the computer and monitor may vary with the type of computer used. An incorrect connection may cause serious damage to both the monitor and the computer. The cable supplied with the monitor is for a standard connector. If a special cable is required please contact your local iiyama dealer or regional iiyama office.
- Make sure you tighten the finger screws at each end of the signal cable.
- The Class I pluggable equipment Type A must be connected to protective earth.
- The socket-outlet shall be installed near the equipment and shall be easily accessible.
- Excessive sound pressure from ear-/headphones can cause hearing damage/hearing loss.

[Example of Connection]

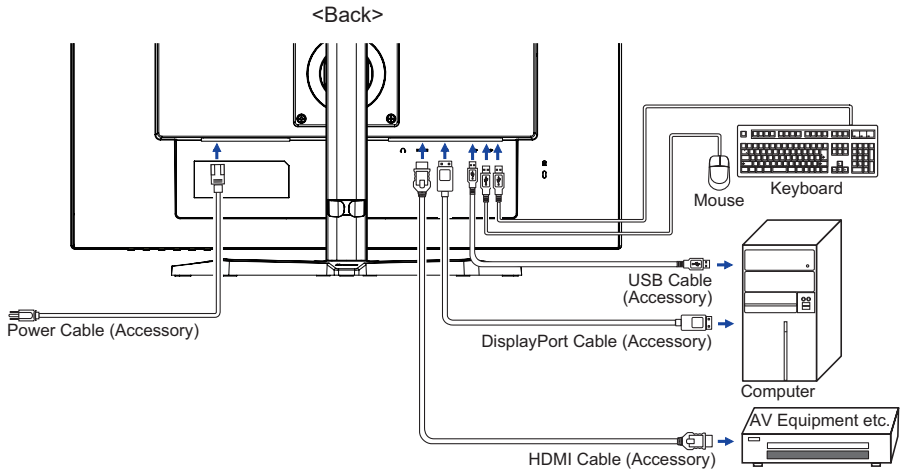

### [ Collect Cables ]

Put the cables through the cable holder to bundle them.

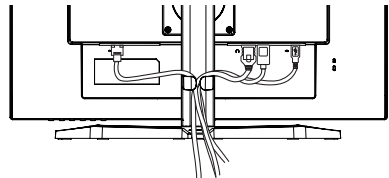

## COMPUTER SETTING

### ■ Signal Timing

Change to the desired signal timing listed on page 30: COMPLIANT TIMING.

## ADJUSTING THE HEIGHT AND THE VIEWING ANGLE

- For optimal viewing it is recommended to position yourself directly opposite to the full face of the monitor, then adjust the monitor's height and angle to your own preference.
- Hold the panel so that the monitor does not topple when you change the monitor's height or angle.
- You are able to adjust the monitor's height up to 150mm and left, 23° upward and 5° downward.

- NOTE**
- Do not touch the LCD screen when you change the height or the angle. It may cause damage or break the LCD screen.
  - Careful attention is required not to pinch your fingers or hands into the moving part of the stand when you change the height or the angle.
  - Injury can occur if care is not taken to avoid finger contact with the displays base when adjusting the height.

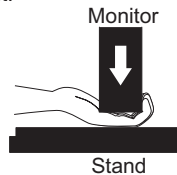
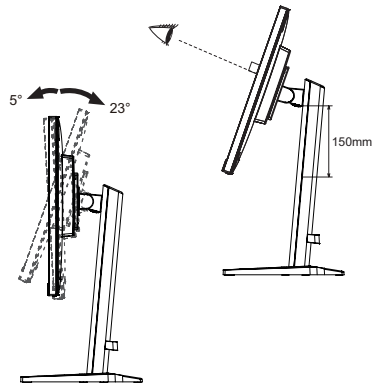

# OPERATING THE MONITOR

To create the best picture, your iiyama LCD monitor has been preset at the factory with the COMPLIANT TIMING shown on page 30. You are also able to adjust the picture by following the button operation shown below.

- 1 Press the ENTER Button to start the On Screen Display feature.



- 2 Use the ◀ / ▶ Buttons to select the Menu which contains the item you want to adjust or set and then press the ENTER Button.
- 3 Use the ◀ / ▶ Buttons to highlight the desired adjustment / setting icon and then press the ENTER Button.
- 4 Use the ◀ / ▶ Buttons again to make the appropriate adjustment or setting and then press the ENTER Button.
- 5 Press the EXIT Button to leave the menu, and the adjustment or setting you just made would be automatically saved.

For example, to correct for OSD vertical position, select Menu item of Setup Menu and then press the ENTER Button. Then, select OSD Vertical Position by using the ◀ / ▶ Buttons. An adjustment scale becomes active after you press the ENTER Button.

Use the ◀ / ▶ Buttons to change the OSD vertical position settings. The OSD vertical position of the overall display should be changing accordingly while you are doing this.

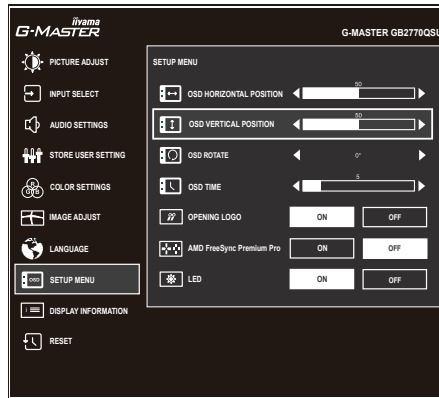

Press the ENTER Button and finally the EXIT Button to close the On Screen Display feature. All changes are saved in the memory.

## NOTE

- When button operations are aborted during adjustment, On-Screen Display disappears when the time set for the OSD Time has passed. Also, press the EXIT Button to quickly turn off the On-Screen Display.
- Any changes are automatically saved in the memory when the On Screen Display disappears. Turning off the power should be avoided while using the Menu.
- All adjustments have only one setting which applies to all signal timings.



# ADJUSTMENT MENU CONTENTS



## Picture Adjust \*1

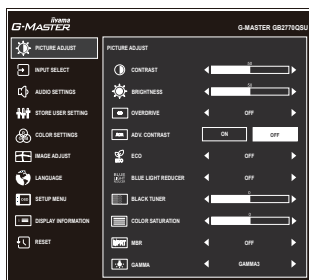

Adjustment Item	Problem / Option	Button to Press
Contrast	Too dark Too bright	
Brightness *2	Too dull Too intense	
Overdrive	Off / 1 / 2 / 3 / 4 / 5 It will improve the gray level response time of the LCD panel. A higher level results in a faster response time.	
Adv. Contrast *3	On	Increased Contrast Ratio
	Off	Typical Contrast Ratio
Eco	Off	Normal
	Mode1	Brightness of back-light is reduced.
	Mode2	Brightness of back-light is reduced more than Mode1.
	Mode3	Brightness of back-light is reduced more than Mode2.
Blue Light Reducer	Off	Typical
	Mode1	Blue light is reduced.
	Mode2	Blue light is reduced more than Mode1.
	Mode3	Blue light is reduced more than Mode2.
Black Tuner	From -5 to +5 You can adjust Dark shades.	
Color Saturation	Too weak	
	Too strong	
MBR *3,4	Off / 1 / 2 / 3 / 4 / 5 / 6 / 7 Improve the moving picture response time of the LCD panel.	
Gamma	Gamma1	
	Gamma2	
	Gamma3	

**Direct**

- \*1 The availability of each item depends on which item is activated. See the Function Correlation Matrix below for more details.
- \*2 Adjust the Brightness when you are using the monitor in a dark room and feel the screen is too bright.
- \*3 Not available when AMD FreeSync Premium Pro is active.
- \*4 MBR is available only when the refresh rate is higher than 75Hz.

## Direct

You can skip the Menu items and directly display an option setting screen by using the following button operations.

- ECO : Press the  Button when the Menu is not displayed.

### ■ Function Correlation Matrix

Active item Selected item	Picture Adjust				Image Adjust	Your Computer
	Adv.Contrast	Eco	Blue Light Reducer	MBR	i-Style Color Standard Sport Game FPS Game Strategy Game Text	HDR
Contrast	–	✓	✓	✓	–	–
Brightness	–	–	✓	✓	–	–
Overdrive	✓	✓	✓	✓	–	✓
Adv. Contrast	–	–	–	–	–	–
Eco	–	–	–	–	–	–
Blue Light Reducer	–	–	–	–	–	–
Black Tuner	✓	✓	✓	✓	–	–
MBR	–	–	–	–	–	–
Gamma	✓	✓	✓	✓	✓	–

✓ : Available

– : Not available



## Input Select

### Direct



Adjustment Item	Option		
Input Source	Auto	Search for an available input source and select automatically.	
	Manual	HDMI	Select the Digital (HDMI) input.
		DisplayPort(DP)	Select the Digital (DisplayPort) input.

**NOTE** Input source is fixed, not selected automatically when HDMI and DisplayPort are selected.



### Direct

You can skip the Menu items and directly display an option setting screen by using the following button operations.

- Input Select : Press the INPUT Button when the Menu is not displayed.

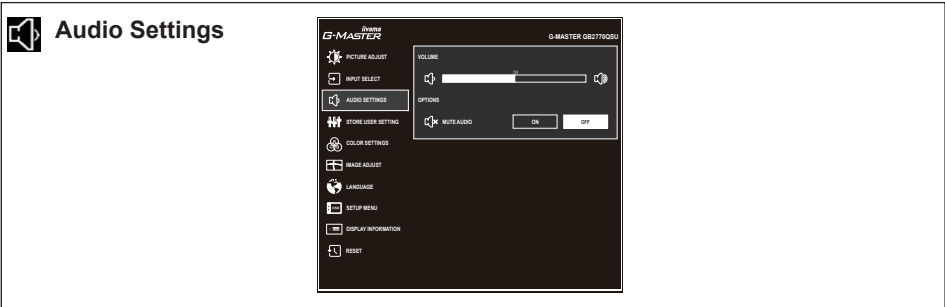



Adjustment Item	Problem / Option		Button to Press
Volume <span style="float: right; border: 1px solid black; padding: 2px;"><b>Direct</b></span>	Too soft Too loud		 
Mute Audio	On	Turn off the sound temporarily.	
	Off	Return the sound volume to the previous level.	
<p><b>NOTE</b> Mute On and Off are switched as follows by pressing the ◀/▶ Buttons successively.</p> <p style="text-align: center;">&gt; On → Off</p>			

**Direct**

You can skip the Menu items and directly display an adjustment scale by using the following button operations.

- Volume : Press the  Button when the Menu is not displayed.



## Store User Setting



Adjustment Item	Option	
User Modes	User Mode 1	Save the settings of the screen adjustment.
	User Mode 2	Save the settings of the screen adjustment.
	User Mode 3	Save the settings of the screen adjustment.

### NOTE

You can memorize your customized monitor settings.

The following settings can be memorized:

Contrast, Brightness, Overdrive, Adv. Contrast, Eco, Black Tuner, Color Saturation, Gamma, Volume, Mute Audio, Color Temperature, User Preset, Sharp and Soft, Video Mode Adjust, X-Res Technology



**Color Settings \***

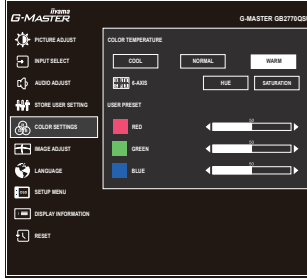

Adjustment Item	Problem / Option		Button to Press	
Color Temperature	Cool	Cool color		
	Normal	Normal color		
	Warm	Warm color		
6-Axis	Hue	Red	Too weak Too strong	 
		Yellow		
		Green		
		Cyan		
		Blue		
		Magenta		
	Saturation	Red	Too weak Too strong	 
		Yellow		
		Green		
		Cyan		
		Blue		
		Magenta		
User Preset	Red	Too weak Too strong	 	
	Green			
	Blue			

\* Not available when Blue Light Reducer or HDR settings on your computer are active.

## Image Adjust

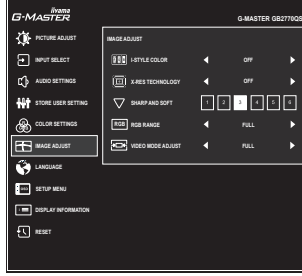

Adjustment Item	Option	Button to Press
i-Style Color * <sup>1</sup>	Off	Return to a state set by color adjustment except i-Style Color.
	Standard	For general windows environment and monitor default setting
	Sport Game	For Sports game environment
	FPS Game	For FPS game environment
	Strategy Game	For Strategy game environment
	Text	For text editing and viewing in a word processing environment
	User Mode 1	Applies customized monitor settings.
	User Mode 2	Applies customized monitor settings.
	User Mode 3	Applies customized monitor settings.
X-Res Technology	Off	Normal
	Soft	Enhance the picture edge.
	Middle	Enhance the picture edge more than the Soft option.
	Hard	Enhance the picture edge more than the Middle option.
Sharp and Soft	1 2 3 4 5 6	You can change the picture quality from 1 to 6 (sharp to soft). Press the ► Button to change the picture quality in numerical order. Press the ◀ Button to change the picture quality in reverse numerical order.
RGB Range	Full	For full-range color scale signal
	Limited	For limited color scale signal
	Auto	Automatically select color scale signal.

\*<sup>1</sup> Not available when Blue Light Reducer or HDR settings on your computer are active.

### Direct

You can skip the Menu items and directly display an option setting screen by using the following button operations.

- i-Style Color: Press the ◀ Button when the Menu is not displayed.



## Image Adjust

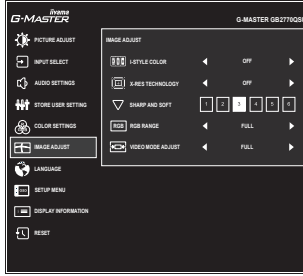

### Adjustment Item

### Option

#### Video Mode Adjust

Full	Expansion display
Aspect * <sup>2</sup>	Expansion display of Aspect
Dot by dot * <sup>3</sup>	Display the picture dot by dot.
17inch	Display the picture as 17 inch screen (5 : 4).
19.5inch	Display the picture as 19.5 inch screen (16 : 9).
21.5inch	Display the picture as 21.5 inch screen (16 : 9).
23inch	Display the picture as 23 inch screen (16 : 9).
23.6inch	Display the picture as 23.6 inch screen (16 : 9).
23.8inch	Display the picture as 23.8 inch screen (16 : 9).
24inch	Display the picture as 24 inch screen (16 : 9).

\*<sup>2</sup> Available only with 16:10, 5:4 and 4:3 resolutions.

\*<sup>3</sup> Available only at resolutions less than 1920 × 1080.





# Language

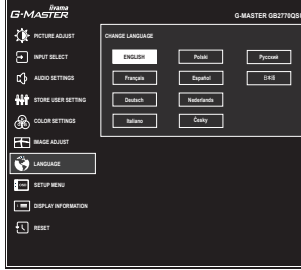

Adjustment Item	Option			
Language	English	English	Español	Spanish
	Français	French	Nederlands	Dutch
	Deutsch	German	Česky	Czech
	Italiano	Italian	Русский	Russian
	Polski	Polish	日本語	Japanese

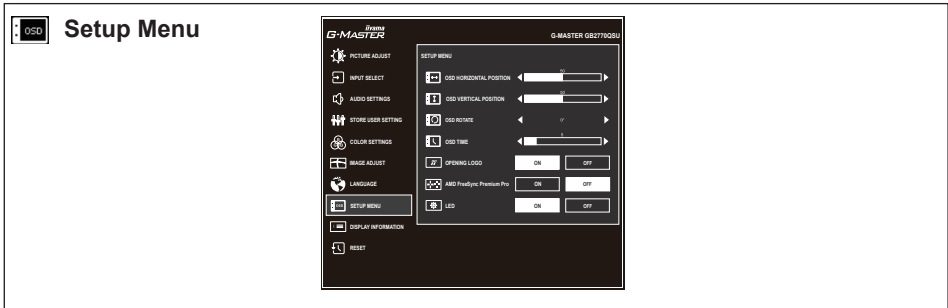

Adjustment Item	Problem / Option		Button to Press
OSD Horizontal Position	OSD is too left OSD is too right		 
OSD Vertical Position	OSD is too low OSD is too high		 
OSD Rotate	Rotate the OSD. 0° (Normal) / +90° (Rotate right)		 
OSD Time	You can set the OSD display duration time between 5 and 30 seconds.		 
Opening Logo	On	G-MASTER Logo is displayed when the monitor is turned on.	
	Off	G-MASTER Logo is not displayed when the monitor is turned on.	
AMD FreeSync Premium Pro *	On	Enable the FreeSync function.	
	Off	The FreeSync function is turned Off.	
LED	On	The Power Indicator is turned On.	
	Off	The Power Indicator is turned Off.	

**NOTE** Turn Off the Power Indicator when you are bothered by the light.

\* The availability depends on which item is activated. See the Function Correlation Matrix below for more details.

**Function Correlation Matrix**

Active item	Picture Adjust				Image Adjust	
	Adv. Contrast	Eco	Blue Light Reducer	MBR	i-Style Color	Video Mode Adjust
					Standard Sport Game FPS Game Strategy Game Text	
Selected Item						
AMD FreeSync Premium Pro	-	✓	✓	-	✓	✓

✓ : Available  
 - : Not available



Displays information regarding the current input signal coming from the graphic card in your computer.

The following will be displayed depending on the settings of your computer.

- HDR on + FS on ;FS2
- HDR on + FS off; HDR: ON
- HDR off + FS on ;SDR: ON
- HDR off + FS off; SDR: ON

**NOTE** See your graphic card user guide for more information about changing the resolution and refresh.

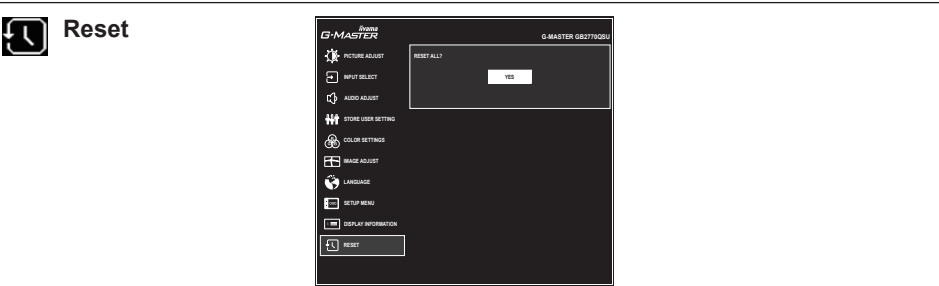

Adjustment Item	Option
Yes	Factory-preset data is restored.

## ● Lock Mode

### <OSD Menu>

Hold the ENTER button and turn on the monitor when the monitor is power-off, it will lock/unlock the OSD Lock function.

### <Power Switch / OSD Menu>

Pressing and holding the ENTER button for 10 seconds when Menu is not displayed, will lock/unlock the Power/OSD Lock function.

## STANDBY FEATURE

This product features the standby function. When activated, it automatically reduces unnecessary power consumption of the monitor when your computer is not in use.

There is a standby step the monitor takes as described below. The standby function, including any timer settings is configured by the operating system. Check your operating system manual for information on how this can be configured.

### ■ Standby Mode

When the video signal from the computer is off, the monitor enters into Standby Mode which reduces the power consumption to less than 0.5W\*. The screen becomes dark, and the power indicator turns to orange. From Standby Mode, the image reappears in several seconds when either the keyboard or the mouse are touched again.

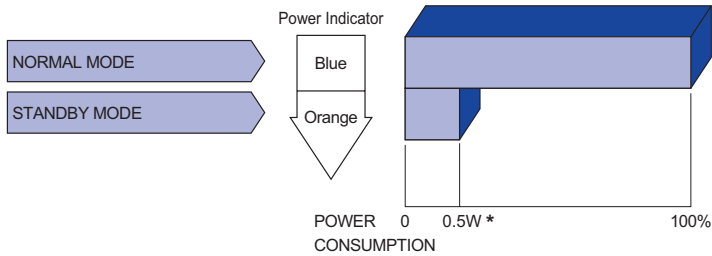

\* When the USB devices are not connected.

# TROUBLE SHOOTING

If the monitor fails to operate correctly, please follow the steps below for a possible solution.

1. Perform the adjustments described in OPERATING THE MONITOR, depending on the problem you have. If the monitor does not get a picture, skip to 2.
2. Consult the following items if you cannot find an appropriate adjustment item in OPERATING THE MONITOR or if the problem persists.
3. If you are experiencing a problem which is not described below or you cannot correct the problem, discontinue using the monitor and contact your dealer or iiyama service center for further assistance.

## Problem

## Check

- ① The picture does not appear.

(Power indicator does not light up.)

- The Power Cable is firmly seated in the socket.
- The Power Switch is turned ON.
- The AC socket is live. Please check with another piece of equipment.

(Power indicator is blue.)

- If the blank screen saver is in active mode, touch the keyboard or the mouse.
- Increase the Contrast and/or Brightness.
- The computer is ON.
- The Signal Cable is properly connected.
- The signal timing of the computer is within the specification of the monitor.

(Power indicator is orange.)

- If the monitor is in standby mode, touch the keyboard or the mouse.
- The computer is ON.
- The Signal Cable is properly connected.
- The signal timing of the computer is within the specification of the monitor.

- ② The screen is not synchronized.

- The Signal Cable is properly connected.
- The signal timing of the computer is within the specification of the monitor.

- ③ The screen position is not in the center.

- The signal timing of the computer is within the specification of the monitor.

- ④ The screen is too bright or too dark.

- The video output level of the computer is within the specification of the monitor.

## Problem

## Check

- |                                       |   |
|---------------------------------------|---|
| ⑤ The screen is shaking.              | <input type="checkbox"/> The power voltage is within the specification of the monitor.<br><input type="checkbox"/> The signal timing of the computer is within the specification of the monitor.  |
| ⑥ No sound.                           | <input type="checkbox"/> The audio equipment (computer etc.) is ON.<br><input type="checkbox"/> The Volume is turned up.<br><input type="checkbox"/> The Mute is OFF.<br><input type="checkbox"/> The audio output level of the audio equipment is within the specification of the monitor. |
| ⑦ The sound is too loud or too quiet. | <input type="checkbox"/> The audio output level of the audio equipment is within the specification of the monitor.  |

## RECYCLING INFORMATION

For better environment protection please don't dispose your monitor.  
Please visit our web site: <https://iiyama.com> for monitor recycling.

# APPENDIX

Design and specifications are subject to change without prior notice.

## SPECIFICATIONS : G-MASTER GB2770QSU-B5

ENGLISH

Size Category	27"	
LCD Panel	Panel technology	FAST IPS
	Size	Diagonal: 27" (68.5cm)
	Pixel pitch	0.233mm H × 0.233mm V
	Brightness	400cd/m <sup>2</sup> (Typical), 155cd/m <sup>2</sup> (Default / Energy Saving)
	Contrast ratio	1000 : 1 (Typical), Adv. Contrast Function Available
	Viewable angle	Right / Left : 89° each, Up / Down : 89° each (Typical)
	MPRT	0.5ms
Display Colors	Approx. 16.7M	
Sync Frequency	HDMI(with FreeSync): Horizontal: 30.0-222.0kHz, Vertical: 40-144Hz HDMI(without FreeSync): Horizontal: 30.0-222.0kHz, Vertical: 56-144Hz DisplayPort(with FreeSync): Horizontal: 242.0kHz, Vertical: 40-165Hz DisplayPort(without FreeSync): Horizontal: 30.0-242.0kHz, Vertical: 56-165Hz	
Native Resolution	2560 × 1440, 3.7 MegaPixels	
Support max. resolution	HDMI(with FreeSync): 2560 × 1440 144Hz HDMI(without FreeSync): 2560 × 1440 144Hz DisplayPort(with FreeSync): 2560 × 1440 165Hz DisplayPort(without FreeSync): 2560 × 1440 165Hz	
Input Connector	HDMI, DisplayPort	
Input Video Signal	HDMI, DisplayPort	
USB Standard	USB3.0 (DC5V, 900mA)	
Number of USB Ports	1 Upstream : Series B	
Connector shape	2 Downstream : Series A	
Headphone Connector	ø 3.5mm mini jack (Stereo)	
Speakers	2W × 2 (Stereo speakers)	
Maximum Screen Size	596.74mm W × 335.66mm H / 23.5" W × 13.2" H	
Power Source	100-240VAC, 50/60Hz, 1.5A	
Power Consumption*	35W typical, Standby mode: 0.5W maximum, Off mode: 0.3W maximum	
Dimensions / Net Weight	614.0 × 400.0 - 550.0 × 252.0mm / 24.1 × 15.7 - 21.6 × 9.9" (W×H×D) 5.7kg / 12.5lbs	
Angle	Tilt: Upward: 23° Downward: 5° Rotation: Clockwise: 90°	
Environmental Considerations	Operating: Temperature 5 to 35°C / 41 to 95°F Humidity 10 to 80% (No condensation) Storage: Temperature -20 to 60°C / -4 to 140°F Humidity 10 to 90% (No condensation)	
Approvals	CE, UKCA, TÜV-Bauart, EAC, VCCI, PSE	

**NOTE** \* When the USB devices are not connected.



# DIMENSIONS

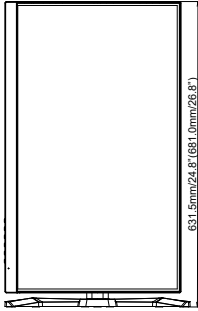
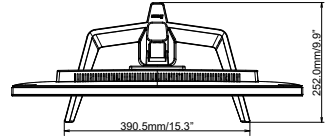
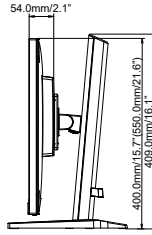
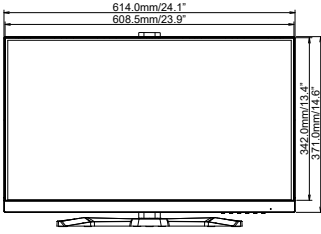

( ) : Maximum adjustment range

## COMPLIANT TIMING

Video Mode	Horizontal Frequency	Vertical Frequency	Dot Clock
640 × 480	31.469kHz	59.940Hz	25.175MHz
800 × 600	37.879kHz	60.317Hz	40.000MHz
	46.875kHz	75.000Hz	49.500MHz
1024 × 768	48.363kHz	60.004Hz	65.000MHz
	60.023kHz	75.029Hz	78.750MHz
1280 × 1024	79.980kHz	75.020Hz	135.000MHz
1600 × 1200	75.000kHz	60.000Hz	162.000MHz
1680 × 1050	65.290kHz	60.000Hz	146.250MHz
1920 × 1080	66.590kHz	59.930Hz	138.500MHz
	184.000kHz	165.000Hz	380.960MHz
2560 × 1440	88.787kHz	59.951Hz	241.500MHz
	221.970kHz	143.856Hz	586.000MHz
	241.065kHz	165.000Hz	636.412MHz

\*

**NOTE** \* DisplayPort input only.