

OptiPlex 7400 All-in-One

Setup and Specifications

Notes, cautions, and warnings

 **NOTE:** A NOTE indicates important information that helps you make better use of your product.

 **CAUTION:** A CAUTION indicates either potential damage to hardware or loss of data and tells you how to avoid the problem.

 **WARNING:** A WARNING indicates a potential for property damage, personal injury, or death.

Chapter 1: Set up your computer	4
Chapter 2: Views of OptiPlex 7400 All-in-One	12
Right.....	12
Left.....	13
Display.....	14
Retractable camera.....	15
Bottom.....	15
Back.....	17
Inside view of your computer.....	18
View of discrete configuration.....	18
View of UMA configuration.....	19
Chapter 3: Specifications of OptiPlex 7400 All-in-One	20
Dimensions and weight.....	20
Processor.....	20
Chipset.....	21
Operating system.....	21
Memory.....	22
Memory matrix.....	22
External ports.....	23
Internal slots.....	23
Ethernet.....	24
Wireless module.....	24
Audio.....	24
Storage.....	25
RAID (Redundant Array of Independent Disks).....	25
Media-card reader.....	26
Camera.....	26
Power ratings.....	27
Power supply connector.....	27
Display.....	28
GPU—Integrated.....	29
Multiple display support matrix.....	29
GPU—Discrete.....	29
Multiple display support matrix.....	30
Hardware security.....	30
Environmental.....	30
Regulatory compliance.....	31
Operating and storage environment.....	31
Chapter 4: Getting help and contacting Dell	32

Set up your computer

1. Set up the stand.



Figure 1. Articulating stand

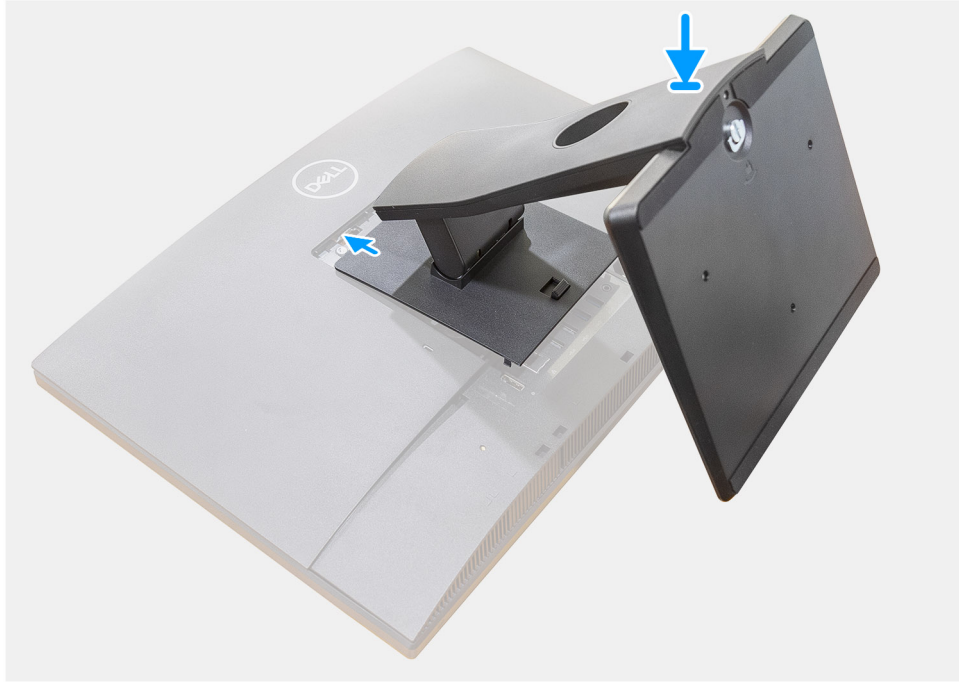

Figure 2. Fixed stand



Figure 3. Height Adjustable Stand

i **NOTE:** Follow the same procedure to install the Height Adjustable Stand with Optical Disk Drive.

2. Connect the keyboard and mouse.

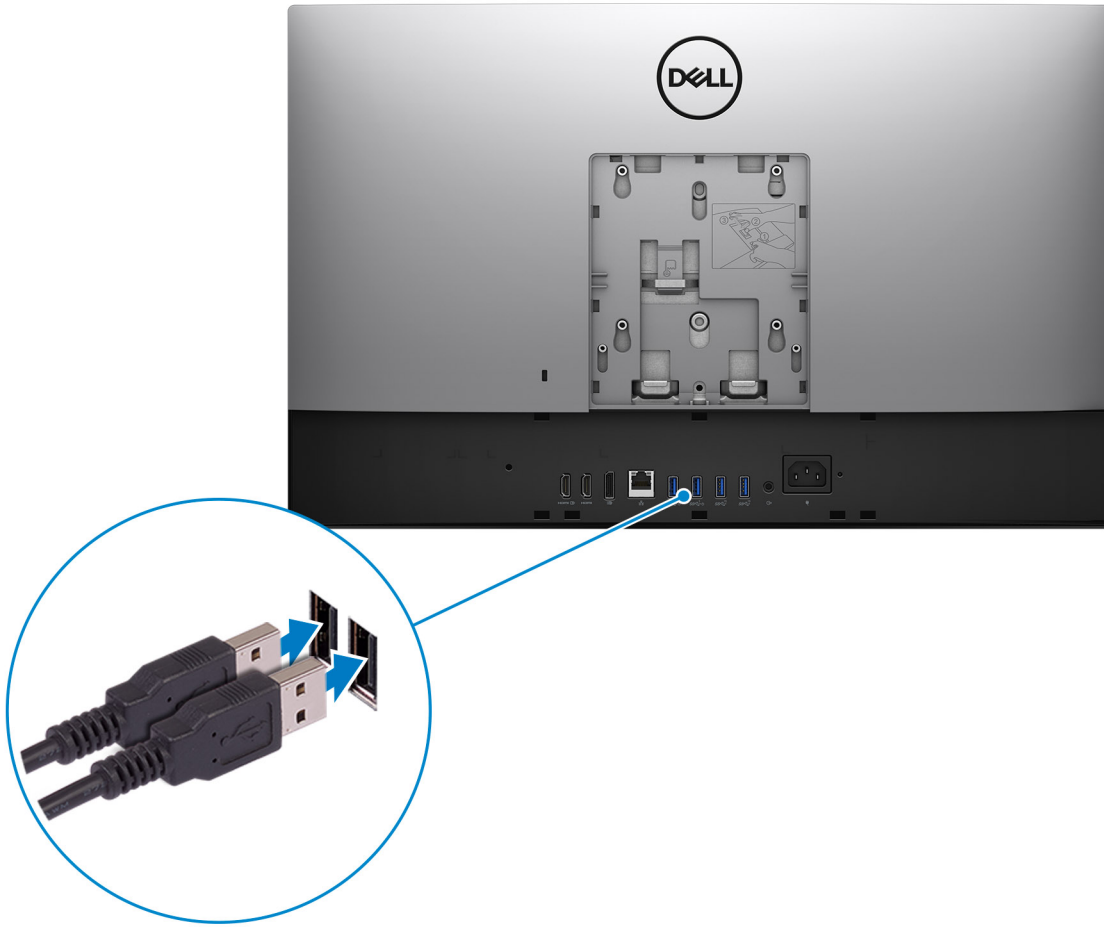

3. Connect to your network using a cable, or connect to a wireless network.

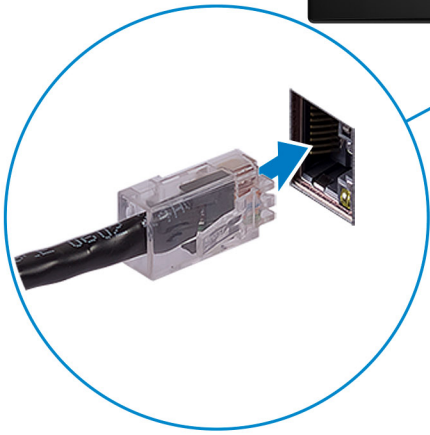
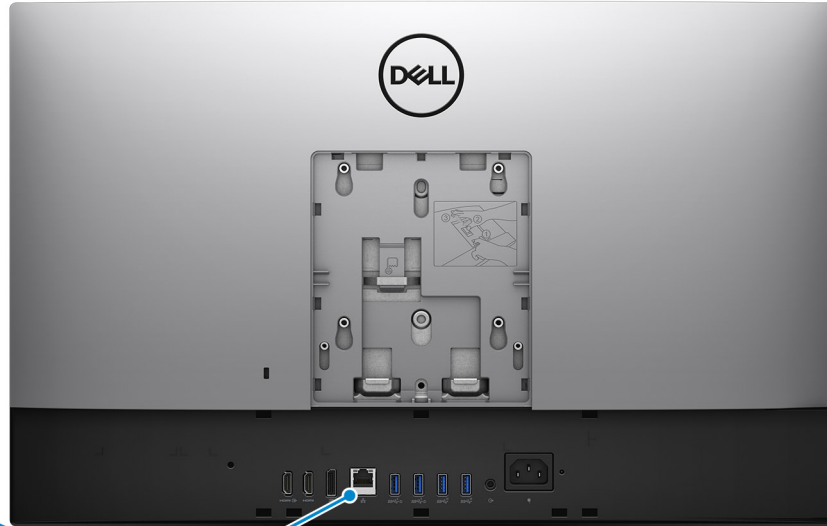

4. Connect the power cable.

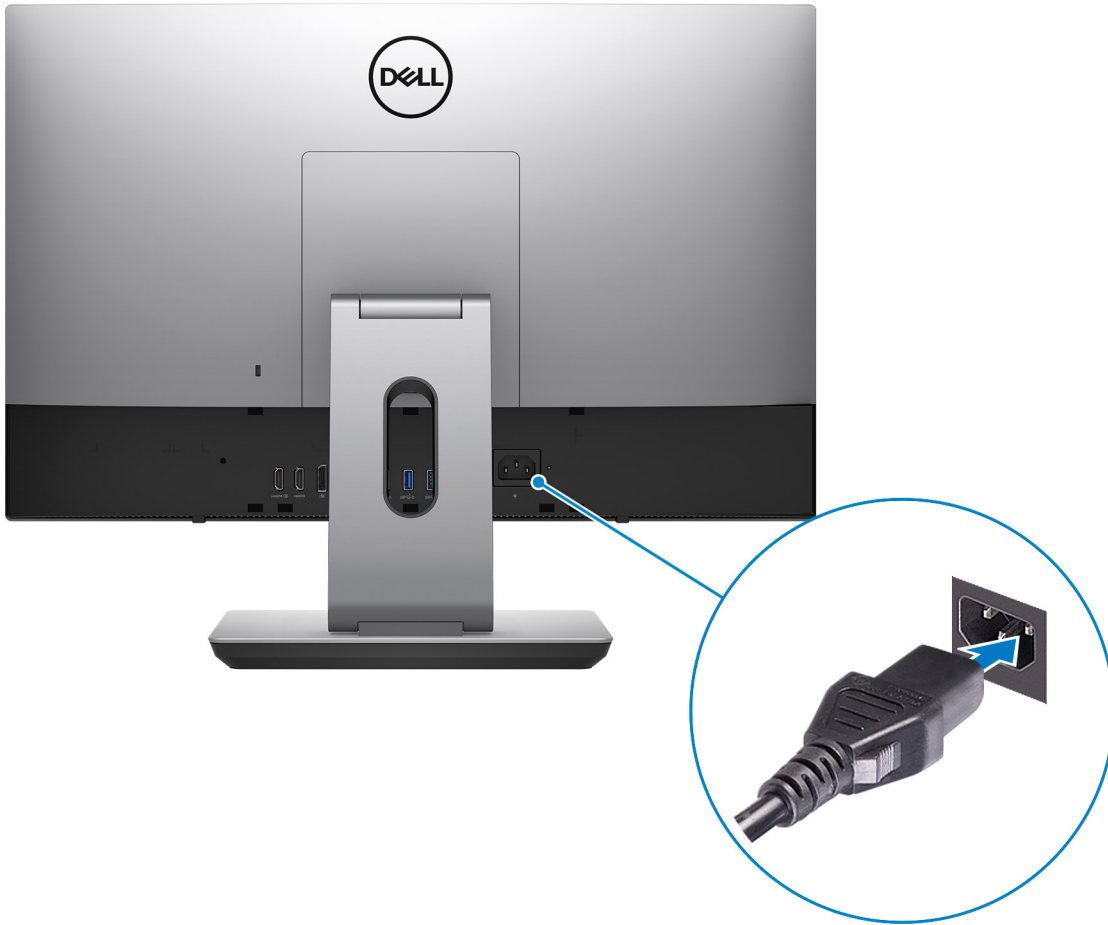

5. Press the power button.



6. Finish operating system setup.

For Ubuntu:

Follow the on-screen instructions to complete the setup. For more information about installing and configuring Ubuntu, see the knowledge base articles [000131655](#) and [000131676](#) at www.dell.com/support.

For Windows:

Follow the on-screen instructions to complete the setup. When setting up, Dell recommends that you:

- Connect to a network for Windows updates.
i **NOTE:** If connecting to a secured wireless network, enter the password for the wireless network access when prompted.
- If connected to the internet, sign-in with or create a Microsoft account. If not connected to the internet, create an offline account.
- On the **Support and Protection** screen, enter your contact details.

7. Locate and use Dell apps from the Windows Start menu—Recommended

Table 1. Locate Dell apps





Resources	Description
	My Dell Centralized location for key Dell applications, help articles, and other important information about your computer. It also notifies you about the warranty status, recommended accessories, and software updates if available.

Table 1. Locate Dell apps (continued)

Resources	Description
	<p>SupportAssist</p> <p>SupportAssist proactively and predictively identifies hardware and software issues on your computer and automates the engagement process with Dell Technical support. It addresses performance and stabilization issues, prevents security threats, monitors, and detects hardware failures. For more information, see <i>SupportAssist for Home PCs User's Guide</i> at www.dell.com/serviceabilitytools. Click SupportAssist and then, click SupportAssist for Home PCs.</p> <p> NOTE: In SupportAssist, click the warranty expiry date to renew or upgrade your warranty.</p>
	<p>Dell Update</p> <p>Updates your computer with critical fixes and latest device drivers as they become available. For more information about using Dell Update, see the knowledge base article 000149088 at www.dell.com/support.</p>
	<p>Dell Digital Delivery</p> <p>Download software applications, which are purchased but not preinstalled on your computer. For more information about using Dell Digital Delivery, see the knowledge base article 000129837 at www.dell.com/support.</p>

Views of OptiPlex 7400 All-in-One

Right

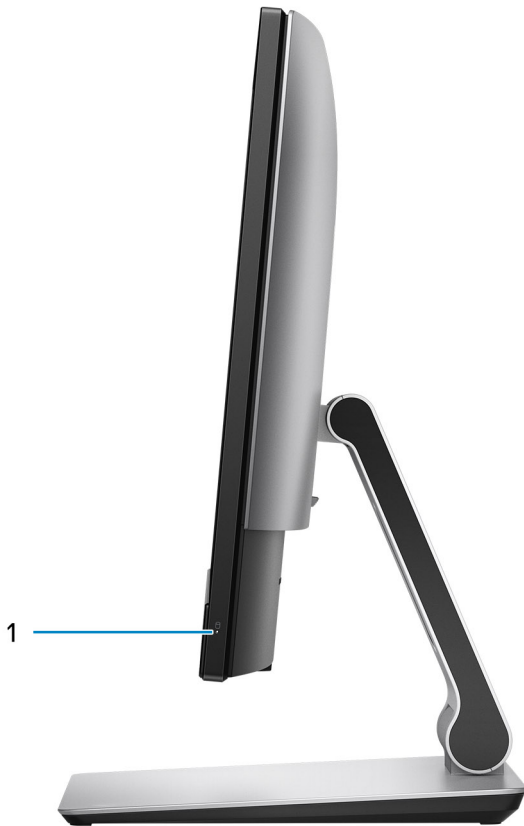

1. Hard-drive status indicator

Left

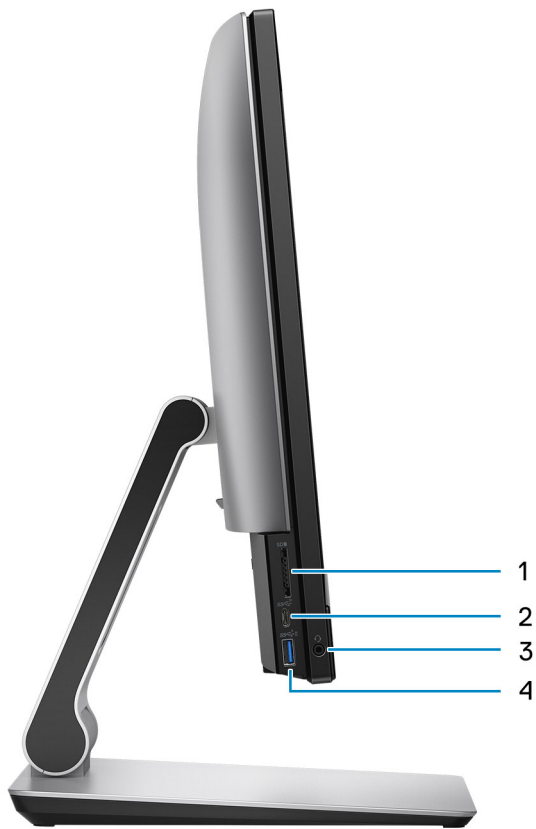

1. SD 4.0 card slot
2. USB 3.2 Gen 2x2 Type-C port
3. Universal audio port
4. USB 3.2 Gen 1 port with PowerShare

Display

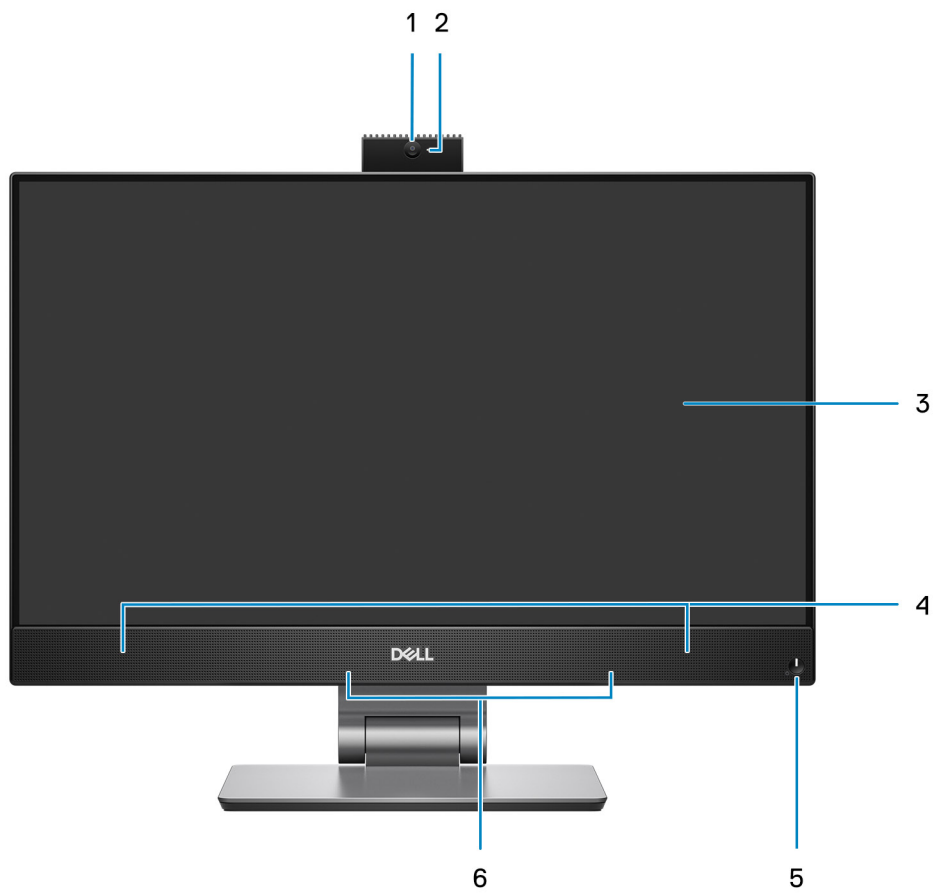

1. Full HD webcam
2. Camera-status light
3. FHD display
4. Speakers
5. Power button and power-status/diagnostic indicator
6. Dual-array microphones

Retractable camera

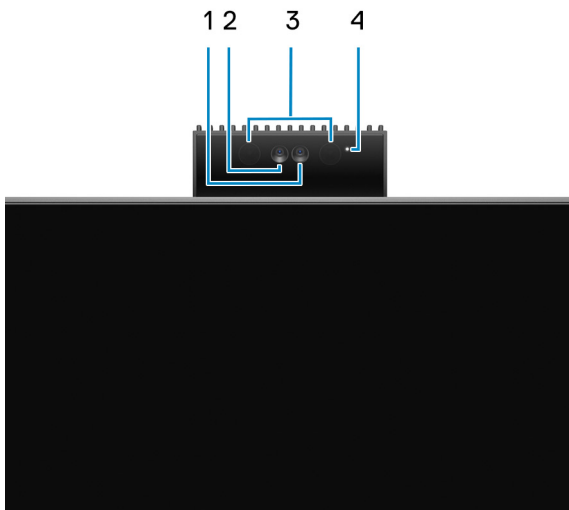

NOTE: Depending on the configuration ordered, your computer will have only RGB camera or both RGB camera and Infrared camera.

1. Full HD camera
2. Infrared camera
3. Infrared emitter
4. Camera-status light

Bottom

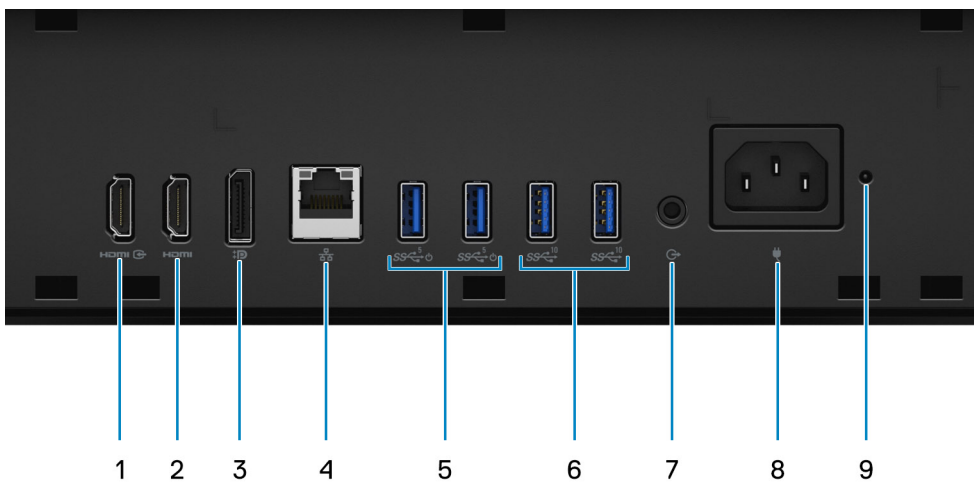

1. HDMI-IN—HDMI 1.4a port
2. HDMI-OUT—HDMI 2.0 port
3. DisplayPort++ 1.4a/HDCP 2.3 port
4. RJ-45 Ethernet port
5. USB 3.2 Gen 1 ports with Smart Power On
6. USB 3.2 Gen 2 ports
7. Line-out audio port
8. Power connector
9. Power-Supply Unit (PSU) status indicator

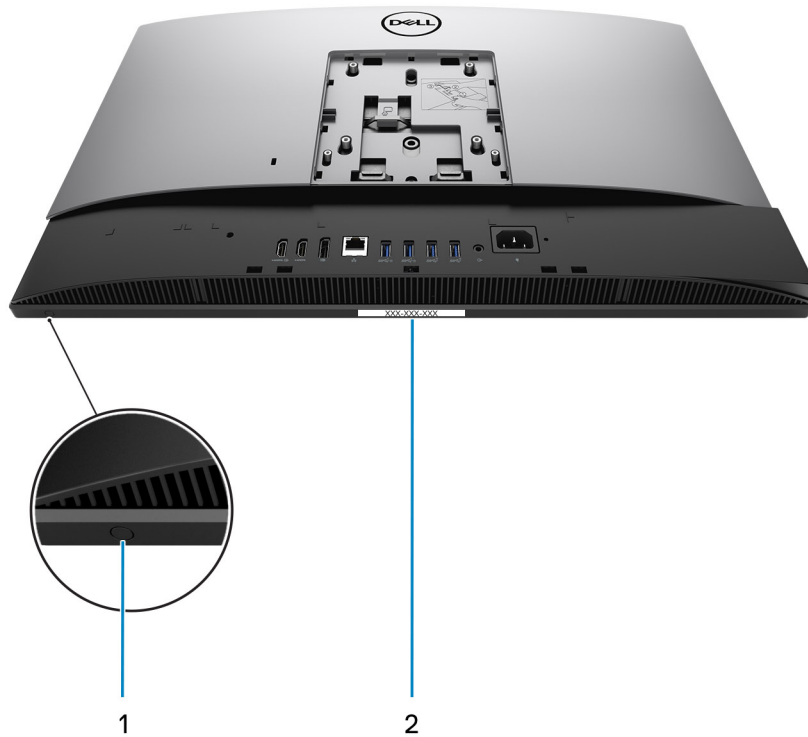

1. Display Built-in Self Test button

This button has two functions:

- When the computer is on, use this button to select the video input-source.
Press the button to switch the display between the internal system display and HDMI input.
- When the computer is off (there is no power; neither is it in sleep state nor hibernate state), use this button to run the built-in selftest for the display.

Press and hold down this button, and then press the power button to turn on the computer. The built-in color pattern for the LCD monitor will appear on the screen.

For more information, see the Troubleshooting section in the Service Manual at www.dell.com/support/manuals.

2. Service tag label

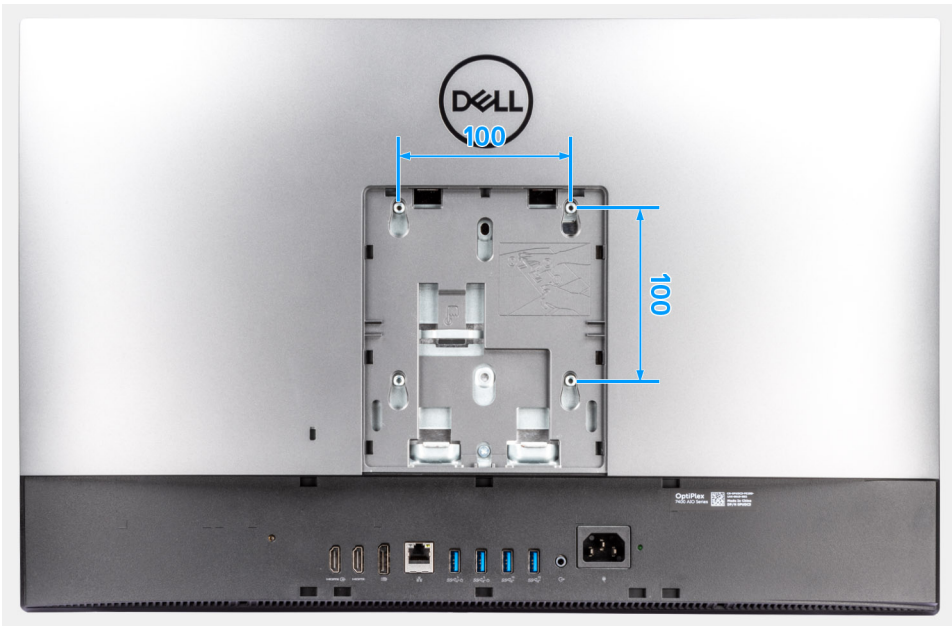

The VESA mount compatibility for OptiPlex 7400 All-in-One is 100x100 mm.

Back

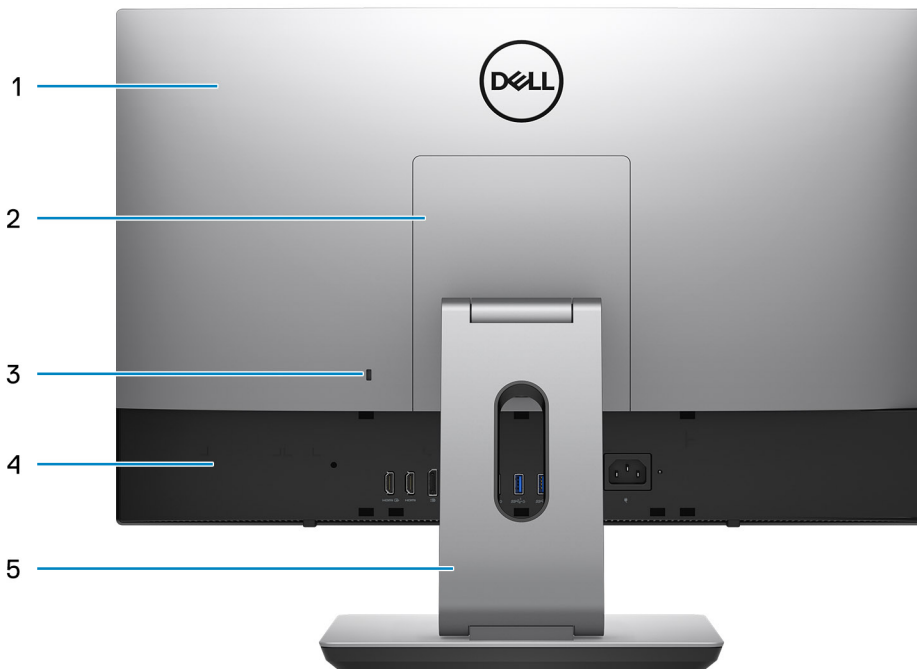

1. Back cover
2. Stand cover

- 3. Kensington security-cable slot
- 4. Bottom cover
- 5. Stand

Inside view of your computer

This section provides information about the components available in your computer.

View of discrete configuration

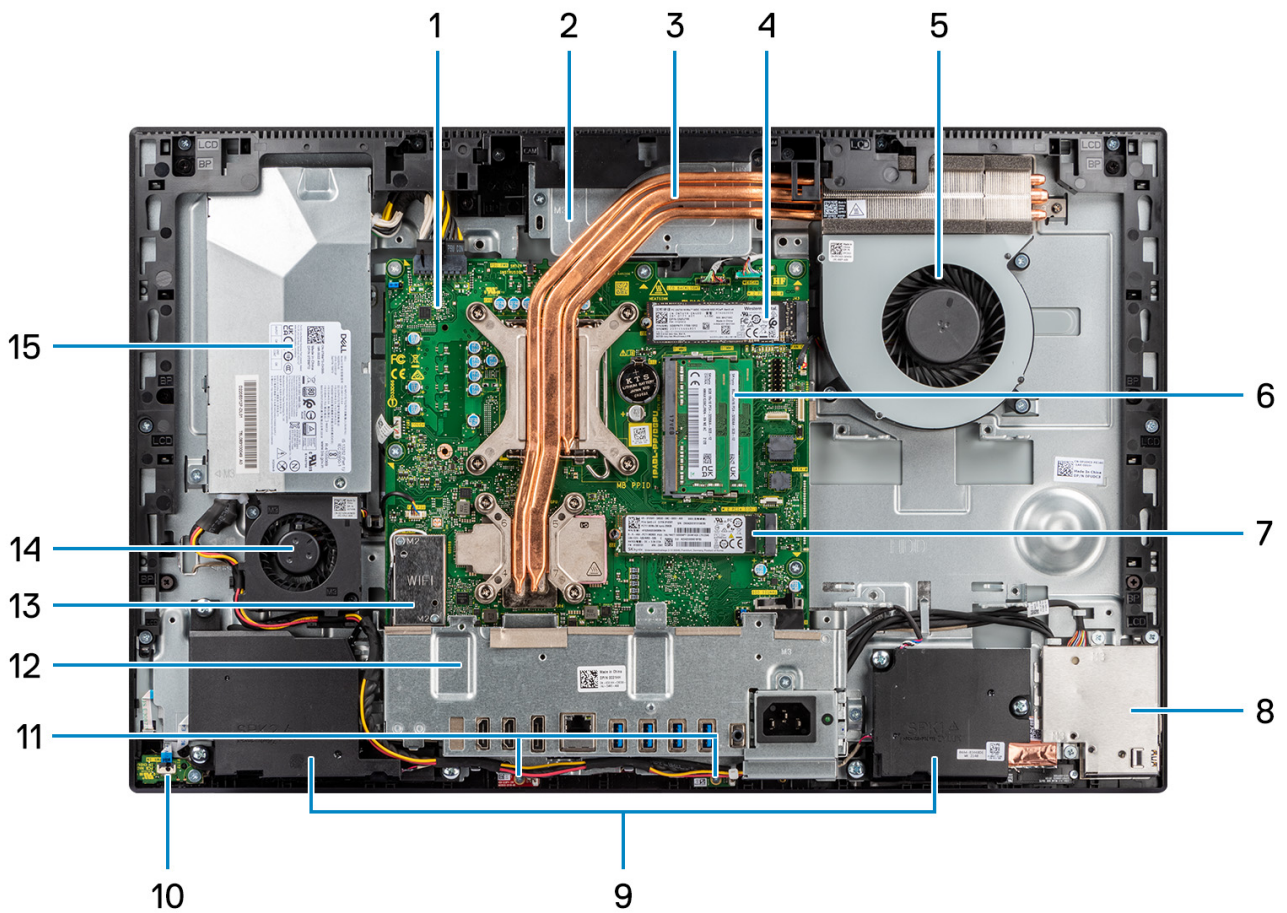

- 1. System board
- 2. Camera assembly
- 3. Heat sink
- 4. M.2 2230/2280 solid-state drive PCIe connector
- 5. Processor fan
- 6. Memory module
- 7. M.2 2230/2280 solid-state drive PCIe connector
- 8. Side-I/O board
- 9. Speakers
- 10. Power button on the power board
- 11. Microphone modules
- 12. Rear-I/O bracket
- 13. Wireless card

- 14. Power-supply fan
- 15. Power-supply unit

View of UMA configuration

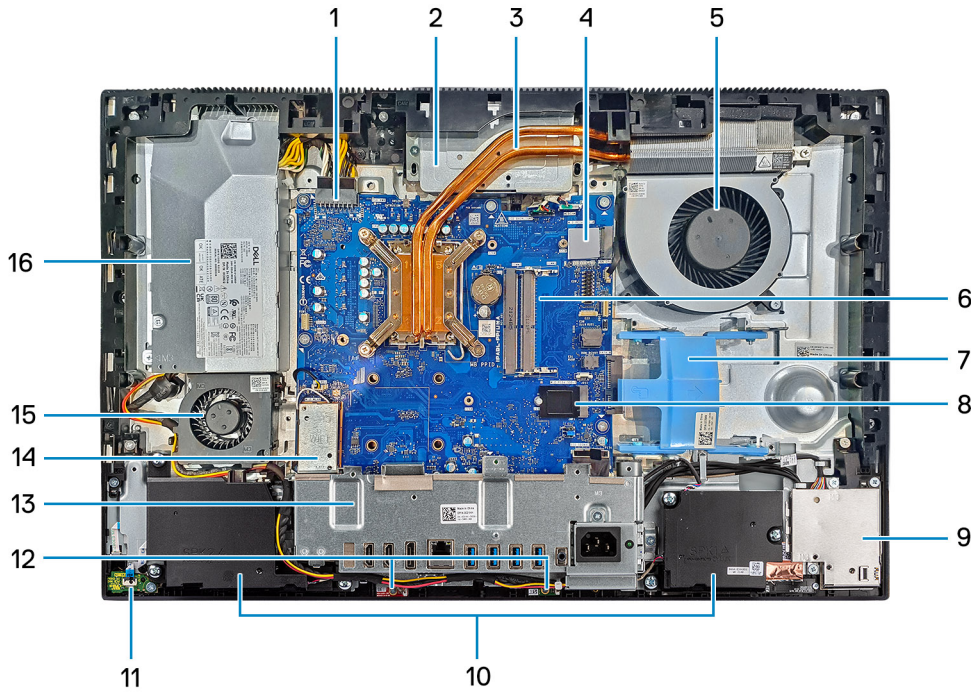

- 1. Power-supply unit connector
- 2. Camera assembly
- 3. Heat sink
- 4. M.2 2230/2280 solid-state drive PCIe connector
- 5. Processor fan
- 6. Memory module
- 7. Hard drive slot
- 8. M.2 2230/2280 solid-state drive PCIe connector
- 9. Side-I/O board
- 10. Speakers
- 11. Power button on the power board
- 12. Microphone modules
- 13. Rear-I/O bracket
- 14. Wireless card
- 15. Power-supply fan
- 16. Power-supply unit

Specifications of OptiPlex 7400 All-in-One

Dimensions and weight

The following table lists the height, width, depth, and weight of your OptiPlex 7400 All-in-One.

Table 2. Dimensions and weight

Description	Values
Height:	
Front height	344.00 mm (13.54 in.)
Rear height	344.00 mm (13.54 in.)
Width	540.20 mm (21.26 in.)
Depth	52.60 mm (2.07 in.)
Weight	Weight without stand
 NOTE: The weight of your computer depends on the configuration ordered and manufacturing variability.	<ul style="list-style-type: none"> • 6.83 Kg (15.06 lbs.)—maximum • 6.18 Kg (13.62 lbs.)—minimum

Processor

The following table lists the details of the processors supported by your OptiPlex 7400 All-in-One.

 **NOTE:** Global Standard Products (GSP) are a subset of Dell's relationship products that are managed for availability and synchronized transitions on a worldwide basis. They ensure the same platform is available for purchase globally. This allows customers to reduce the number of configurations managed on a worldwide basis, thereby reducing their costs. They also enable companies to implement global IT standards by locking in specific product configurations worldwide.

Device Guard (DG) and Credential Guard (CG) are the new security features that are only available on Windows 10 Enterprise today. Device Guard is a combination of enterprise-related hardware and software security features. When you configure together, it locks a device and it can only run trusted applications. Credential Guard uses virtualization-based security to isolate secrets (credentials) and only privileged system software can access the system. Unauthorized access to these secrets can lead to credential theft attacks. Credential Guard prevents these attacks by protecting NTLM password hashes and Kerberos Ticket Granting Tickets.

 **NOTE:** Processor numbers are not a measure of performance. Processor availability subject to change and may vary by region/country.

Table 3. Processor

Description	Option one	Option two	Option three	Option four	Option five	Option six	Option seven
Processor type	12 th Generation Intel Core i3-12100	12 th Generation Intel Core i3-12300	12 th Generation Intel Core i5-12400	12 th Generation Intel Core i5-12500	12 th Generation Intel Core i5-12600	12 th Generation Intel Core i7-12700	12 th Generation Intel Core i9-12900
Processor wattage	60 W	60 W	65 W	65 W	65 W	65 W	65 W

Table 3. Processor (continued)

Description	Option one	Option two	Option three	Option four	Option five	Option six	Option seven
Processor core count	4	4	6	6	6	12	16
Processor thread count	8	8	12	12	12	20	24
Processor speed	3.30 GHz to 4.30 GHz	3.50 GHz to 4.40 GHz	2.50 GHz to 4.40 GHz	3 GHz to 4.60 GHz	3.30 GHz to 4.80 GHz	2.10 GHz to 4.90 GHz	2.40 GHz to 5.10 GHz
Processor cache	12 MB	12 MB	18 MB	18 MB	18 MB	25 MB	30 MB
Integrated graphics	Intel UHD Graphics 730	Intel UHD Graphics 730	Intel UHD Graphics 730	Intel UHD Graphics 770	Intel UHD Graphics 770	Intel UHD Graphics 770	Intel UHD Graphics 770

Chipset

The following table lists the details of the chipset supported by your OptiPlex 7400 All-in-One.

Table 4. Chipset

Description	Values
Chipset	Intel Q670 PCH
Processor	12 th Generation Intel Core i3/i5/i7/i9
DRAM bus width	<ul style="list-style-type: none"> 64-bit (for single-channel) 128-bit (for dual-channel)
Flash EPROM	32 MB
PCIe bus	Up to Gen 3.0

Operating system

Your OptiPlex 7400 All-in-One supports the following operating systems:

- windows 11 Home, 64-bit
- Windows 11 Home National Academic, 64-bit
- Windows 11 Pro, 64-bit
- Windows 11 Pro National Academic, 64-bit
- Windows 11 CMIT Government Edition, 64-bit (China only)
- Windows 11 Downgrade (Windows 10 image)
- Ubuntu Linux 20.04 LTS, 64-bit
- Kylin Linux Desktop version 10.1 (China only)

For more information about Dell OS Recovery image, see How to Download and Use the Dell OS Recovery Image in Microsoft Windows, at [Dell support site](#).

Commercial platform Windows 11 N-2 and 5-year operating system supportability:

All newly introduced 2019 and later commercial platforms (Latitude, OptiPlex, and Dell Precision) will qualify and ship with the most current factory installed Semi-Annual Channel Windows 11 version (N) and qualify (but not ship) the previous two versions (N-1, N-2). The OptiPlex 7400 All-in-One will RTS with Windows 11 version v20H2 at time of launch, and this version will determine the N-2 versions that are initially qualified for this platform.

For future versions of Windows 11, Dell continues to test the commercial platform with coming Windows 11 releases during device production and for five years post-production, including both fall and spring releases from Microsoft.

For additional information about N-2 and 5-year Windows operating system supportability, see the Dell Windows as a Service (WaaS), at [Dell support site](#).

EOML 411

The OptiPlex 7400 All-in-One continues to test the coming Semi-Annual Channel Windows 11 version releases for five years post-production, including both fall and spring releases from Microsoft.

Memory

The following table lists the memory specifications of your OptiPlex 7400 All-in-One.

Table 5. Memory specifications

Description	Values
Memory slots	Two-SoDIMM
Memory type	DDR4
Memory speed	3200 MHz
Maximum memory configuration	64 GB
Minimum memory configuration	4 GB
Memory size per slot	4 GB, 8 GB, 16 GB, 32 GB
Memory configurations supported	<ul style="list-style-type: none"> • 4 GB, 1 x 4 GB, DDR4, 3200 MHz • 8 GB, 1 x 8 GB, DDR4, 3200 MHz • 16 GB, 1 x 16 GB, DDR4, 3200 MHz • 16 GB, 2 x 8 GB, DDR4, 3200 MHz, dual-channel • 32 GB, 1 x 32 GB, DDR4, 3200 MHz • 32 GB, 2 x 16 GB, DDR4, 3200 MHz, dual-channel • 64 GB, 2 x 32 GB, DDR4, 3200 MHz, dual-channel

Memory matrix

The following table lists the memory configurations supported on your OptiPlex 7400 All-in-One.

Table 6. Memory matrix

Configuration	Slot	
	SO-DIMM1	SO-DIMM2
4 GB DDR4	4 GB	NA
8 GB DDR4	8 GB	NA
16 GB DDR4	16 GB	NA
16 GB DDR4	8 GB	8 GB
32 GB DDR4	32 GB	NA
32 GB DDR4	16 GB	16 GB
64 GB DDR4	32 GB	32 GB

External ports

The following table lists the external ports of your OptiPlex 7400 All-in-One.

Table 7. External ports

Description	Values
Network port	One RJ45 Ethernet port (rear)
USB ports	<ul style="list-style-type: none"> One USB 3.2 Gen 2x2 Type-C port (side) One USB 3.2 Gen 1 port with PowerShare (side) Two USB 3.2 Gen 2 ports (rear) Two USB 3.2 Gen 1 ports with Smart Power On (rear)
Audio port	<ul style="list-style-type: none"> One universal audio port (side) One Line-out audio port (rear)
Video port	<ul style="list-style-type: none"> One DisplayPort++ 1.4a/HDCP 2.3 port One HDMI-IN—HDMI 1.4a port One HDMI-OUT—HDMI 2.0 port
Media-card reader	One SD 4.0 card slot (side)
Power-adaptor port	Not supported
Security-cable slot	One Kensington security-cable slot

- PowerShare port—Provides data transfer speed up to 5 Gbps. PowerShare enables you to charge your USB devices even when your computer is turned off.
- Smart Power On port—Provides data transfer speed up to 5 Gbps. Wakes the computer from standby with the keyboard or mouse connected to this port through BIOS settings.

Internal slots

The following table lists the internal slots of your OptiPlex 7400 All-in-One.

Table 8. Internal slots

Description	Values
PCIe expansion card slots	Not supported
mSATA	Not supported
SATA	One SATA slot for 2.5-inch hard drive (with UMA configuration)
M.2	<ul style="list-style-type: none"> One M.2 2230 slot for Wi-Fi and Bluetooth card Two M.2 2230/2280 slots for SSD <p> NOTE: To learn more about the features of different types of M.2 cards, see the knowledge base article 000144170 at www.dell.com/support.</p>

Ethernet

The following table lists the wired Ethernet Local Area Network (LAN) specifications of your OptiPlex 7400 All-in-One.

Table 9. Ethernet specifications

Description	Values
Model number	Intel i219-LM
Transfer rate	10/100/1000 Mbps

Wireless module

The following table lists the Wireless Local Area Network (WLAN) module specifications of your OptiPlex 7400 All-in-One.

Table 10. Wireless module specifications

Description	Option one	Option two	Option three
Model number	Intel AX201	Intel AX211	Realtek RTL8822CE
Transfer rate	Up to 2400 Mbps	Up to 2400 Mbps	Up to 867 Mbps
Frequency bands supported	2.4 GHz/5 GHz	2.4 GHz/5 GHz/6 GHz	2.4 GHz/5 GHz
Wireless standards	<ul style="list-style-type: none"> • WiFi 802.11a/b/g • Wi-Fi 4 (WiFi 802.11n) • Wi-Fi 5 (WiFi 802.11ac) • Wi-Fi 6 (WiFi 802.11ax) 	<ul style="list-style-type: none"> • WiFi 802.11a/b/g • Wi-Fi 4 (WiFi 802.11n) • Wi-Fi 5 (WiFi 802.11ac) • Wi-Fi 6E (WiFi 802.11ax) 	<ul style="list-style-type: none"> • Wi-Fi 802.11a/b/g • Wi-Fi 4 (Wi-Fi 802.11n) • Wi-Fi 5 (Wi-Fi 802.11ac)
Encryption	<ul style="list-style-type: none"> • 64-bit/128-bit WEP • AES-CCMP • TKIP 	<ul style="list-style-type: none"> • 64-bit and 128-bit WEP • AES-CCMP • TKIP 	<ul style="list-style-type: none"> • 64-bit/128-bit WEP • AES-CCMP • TKIP
Bluetooth	Bluetooth 5.2	Bluetooth 5.2	Bluetooth 5.0

Audio

The following table lists the audio specifications of your OptiPlex 7400 All-in-One.

Table 11. Audio specifications

Description	Values
Audio controller	Realtek Codec ALC3289
Stereo conversion	Realtek Codec ALC3289 capability supporting 44.1 k/48 k/96 k/192 kHz sample rate DAC conversion
Internal audio interface	High definition audio interface
External audio interface	Universal audio jack
Number of speakers	Two (Stereo speakers with Waves MaxxAudio® Pro, 5W x 2 = 10 W total)
Internal-speaker amplifier	Realtek Amplifier ALC1302

Table 11. Audio specifications (continued)

Description		Values
External volume controls		No hardware volume buttons
Speaker output:		
	Average speaker output	5 W
	Peak speaker output	6 W
Subwoofer output		Not applicable
Microphone		Two—MEMS microphones

Storage

This section lists the storage options on your OptiPlex 7400 All-in-One.

Table 12. Storage matrix

Storage		Single M.2 socket	2 nd M.2 socket
M.2 SSD Boot		Yes	Yes
M.2 SSD Boot	SSD	Yes	Yes
M.2 SSD Boot	SSD	RAID0 or RAID1	RAID0 or RAID1

Table 13. Storage specifications

Storage type	Interface type	Capacity
M.2 2230, Class 35 SSD	PCIe NVMe Gen3 x4	Up to 1 TB
M.2 2230, Class 35 SSD, self-encrypting drive	PCIe NVMe Gen3 x4	256 GB
M.2 2280, Class 40 SSD	PCIe NVMe Gen3 x4	Up to 2 TB
M.2 2280, Class 40 SSD, self-encrypting drive	PCIe NVMe Gen3 x4	Up to 1 TB

RAID (Redundant Array of Independent Disks)

For optimal performance when configuring drives as a RAID volume, it requires identical drive models.

RAID 0 (Striped, Performance) volumes benefit from higher performance when drives are matched because the data is split across multiple drives: any IO operations with block sizes larger than the stripe size will split the IO and become constrained by the slowest of the drives. For RAID 0 IO operations where block sizes are smaller than the stripe size, whichever drive the IO operation targets will determine the performance, which increases variability and results in inconsistent latencies. This variability is particularly pronounced for write operations and it can be problematic for applications that are latency sensitive. One such example of this is any application that performs thousands of random writes per second in very small block sizes.

RAID 1 (Mirrored, Data Protection) volumes benefit from higher performance when drives are matched because the data is mirrored across multiple drives: all IO operations must be performed identically to both drives, thus variations in drive performance when the models are different, results in the IO operations completing only as fast as the slowest drive. While this does not suffer the variable latency issue in small random IO operations as with RAID 0 across heterogeneous drives, the impact is nonetheless large because the higher performing drive becomes limited in all IO types. One of the worst examples of constrained performance here is when using unbuffered IO. To ensure writes are fully committed to non-volatile regions of the RAID volume, unbuffered IO bypasses cache (for example by using the Force Unit Access bit in the NVMe protocol) and the IO

operation will not complete until all the drives in the RAID volume have completed the request to commit the data. This kind of IO operation completely negates any advantage of a higher performing drive in the volume.

Care must be taken to match not only the drive vendor, capacity, and class, but also the specific model. Drives from the same vendor, with the same capacity, and even within the same class, can have very different performance characteristics for certain types of IO operations. Thus, matching by model ensures that the RAID volumes is comprised of an homogeneous array of drives that will deliver all the benefits of a RAID volume without incurring the additional penalties when one or more drives in the volume are lower performing.

Media-card reader

The following table lists the media cards supported by your OptiPlex 7400 All-in-One.

Table 14. Media-card reader specifications

Description	Values
Media-card type	One Secure Digital (SD) 4.0 card
Media-cards supported	<ul style="list-style-type: none"> Secure Digital High Capacity (SDHC) Secure Digital Extended Capacity (SDXC) Secure Digital (SD) 4.0 SD UHS-I (UHS104) SD UHS-II
<p>NOTE: The maximum capacity supported by the media-card reader varies depending on the standard of the media card installed in your computer.</p>	

Camera

The following table lists the camera specifications of your OptiPlex 7400 All-in-One.

Table 15. Full HD RGB Infrared Webcam

Description	Values
Number of cameras	One
Camera type	FHD RGB camera/Infrared camera
Camera location	Front pop-up camera
Camera sensor type	CMOS sensor technology
Focus detail	<ul style="list-style-type: none"> Fixed focus Focus area—23 cm ~ Infinity
Camera resolution:	
Still image	2.07 megapixels
Video	1920 x 1080 (FHD) at 30 fps
Infrared camera resolution:	
Still image	0.30 megapixels
Video	640 x 480 (VGA) at 30 fps
Diagonal viewing angle:	

Table 15. Full HD RGB Infrared Webcam (continued)

Description		Values
	Camera	77.50 degrees
	Infrared camera	82.90 degrees

Table 16. Full HD RGB Webcam

Description		Values
Number of cameras		One
Camera type		FHD RGB camera
Camera location		Front pop-up camera
Camera sensor type		CMOS sensor technology
Camera resolution:		
	Still image	2.07 megapixels
	Video	1920 x 1080 (FHD) at 30 fps
Diagonal viewing angle:		77.40 degrees

Power ratings

The following table lists the power rating specifications of OptiPlex 7400 All-in-One.

Table 17. Power ratings

Description	Option one	Option two
Type	160 W Bronze	220 W Platinum
Input voltage	90 VAC to 264 VAC	90 VAC to 264 VAC
Input frequency	47 Hz to 63 Hz	47 Hz to 63 Hz
Input current (maximum)	3.6 A	3.6 A
Output current (continuous)	<ul style="list-style-type: none"> • +19.5 VA/7.5 A • +19.5 VB/7.0 A Standby mode: <ul style="list-style-type: none"> • +19.5 VA/0.5 A • +19.5 VB/1.75 A 	<ul style="list-style-type: none"> • +19.5 VA/8.5 A • +19.5 VB/9.2 A Standby mode: <ul style="list-style-type: none"> • +19.5 VA/0.5 A • +19.5 VB/1.75 A
Rated output voltage	<ul style="list-style-type: none"> • +19.5 VA • +19.5 VB 	<ul style="list-style-type: none"> • +19.5 VA • +19.5 VB
Temperature range		
	Operating	5°C to 42°C (41°F to 107°F)
	Storage	-40°C to 70°C (-40°F to 158°F)

Power supply connector

The following table lists the Power supply connector specifications of your OptiPlex 7400 All-in-One.

Table 18. Power supply connector

160 W (80 PLUS Bronze)	<ul style="list-style-type: none"> • One 16 pin connector for system board
------------------------	---

Table 18. Power supply connector (continued)

	<ul style="list-style-type: none"> One 2 pin connector for LED
220 W (80 PLUS Platinum)	<ul style="list-style-type: none"> One 16 pin connector for system board One 2 pin connector for LED

Display

The following table lists the display specifications of your OptiPlex 7400 All-in-One.

Table 19. Display specifications

Description	Option one (non-touch display)	Option two (touch-display)
Display type	Full High Definition (FHD), Low Blue Light	Full High Definition (FHD)
Display-panel technology	Wide Viewing Angle (WVA)	Wide Viewing Angle (WVA)
Display-panel dimensions (active area):		
Height	296.46 mm (11.67 in.)	296.46 mm (11.67 in.)
Width	527.04 mm (20.75 in.)	527.04 mm (20.75 in.)
Diagonal	604.70 mm (23.81 in.)	604.70 mm (23.81 in.)
Display-panel native resolution	1920 x 1080	1920 x 1080
Luminance	<ul style="list-style-type: none"> 250 Nits (typical) 200 Nits (minimum) 	<ul style="list-style-type: none"> 250 Nits (typical) 200 Nits (minimum)
Megapixels	2.07	2.07
Color gamut	99% sRGB (typical)	72% NTSC typical
Pixels Per Inch (PPI)	92	92
Contrast ratio	<ul style="list-style-type: none"> 700:1 (minimum) 1000:1 (typical) 	<ul style="list-style-type: none"> 700:1 (minimum) 1000:1 (typical)
Response time	<ul style="list-style-type: none"> 25 ms (maximum) 14 ms (typical) 	<ul style="list-style-type: none"> 25 ms (maximum) 14 ms (typical)
Refresh rate	60 Hz	60 Hz
Horizontal view angle	<ul style="list-style-type: none"> 170 degrees (minimum) 178 degrees (typical) 	<ul style="list-style-type: none"> 170 degrees (minimum) 178 degrees (typical)
Vertical view angle	<ul style="list-style-type: none"> 170 degrees (minimum) 178 degrees (typical) 	<ul style="list-style-type: none"> 170 degrees (minimum) 178 degrees (typical)
Pixel pitch	0.2745 x 0.2745 mm	0.2745 x 0.2745 mm
Power consumption (maximum)	12.70 W	13.48 W
Anti-glare vs glossy finish	Anti-glare	Anti-glare
Adaptive sync	Not applicable	Not applicable
Stylus support	Not applicable	Capacitive touch

Table 19. Display specifications (continued)

Description	Option one (non-touch display)	Option two (touch-display)
Multi-touch feature supported	Not applicable	10-points multi-touch
Display surface	Anti-glare treatment of the front polarizer (Haze 25%, 3H)	Anti-glare treatment of the front polarizer (Haze 25%, 3H)

GPU—Integrated

The following table lists the specifications of the integrated Graphics Processing Unit (GPU) supported by your OptiPlex 7400 All-in-One.

Table 20. GPU—Integrated

Controller	Memory size	Processor
Intel UHD Graphics 730	Shared system memory	12 th Generation Intel Core i3-12100, i3-12300, and i5-12400 processors
Intel UHD Graphics 770	Shared system memory	12 th Generation Intel Core i5-12500/i5-12700/i7/i9 processors

Multiple display support matrix

The following table lists the multiple display support matrix for your OptiPlex 7400 All-in-One.

Table 21. Multiple display support matrix

Description	Option 1	Option 2
Integrated Graphics Card	Intel UHD Graphics 730	Intel UHD Graphics 770
Optional Module	NA	NA
Supported 4K Displays	<ul style="list-style-type: none"> On board integrated DP1.4 HBR3 (5120 x 3200 @ 60 Hz) On board integrated HDMI 2.0 (4096 x 2160 @ 60 Hz) 	<ul style="list-style-type: none"> On board integrated DP1.4 HBR3 (5120 x 3200 @ 60 Hz) On board integrated HDMI 2.0 (4096 x 2160 @ 60 Hz)
Supported 5K Displays	On board integrated DP1.4 HBR3 (5120 x 3200 @ 60 Hz)	On board integrated DP1.4 HBR3 (5120 x 3200 @ 60 Hz)

GPU—Discrete

The following table lists the specifications of the discrete Graphics Processing Unit (GPU) supported by your OptiPlex 7400 All-in-One.

Table 22. GPU—Discrete

Controller	Memory size	Memory type
AMD Radeon RX 6500M	4 GB	GDDR6

Multiple display support matrix

The following table lists the multiple display support matrix for your OptiPlex 7400 All-in-One.

Table 23. Multiple display support matrix

Graphics Card	Memory	Ports	Supported external displays with Direct Connect	Supported external displays with DP Multi-Stream	Supported 4K Displays	Supported 5K Displays	Resolution	Total Power
AMD Radeon RX 6500M	4 GB GDDR 6	HDMI OUT—HDMI 2.0 port	One HDMI 2.0 port	Not supported	Yes	Not supported	3840 x 2160 @ 60 Hz	50 W

Hardware security

The following table lists the hardware security of your OptiPlex 7400 All-in-One.

Table 24. Hardware security

Hardware security
Dell Lockable port cover (optional)
Chassis lock slot support
Noble Custom AIO Plate Lock (optional)
Supply chain tamper alerts
Chassis intrusion switch
Trusted Platform Module (Discrete TPM Enabled)
SafeBIOS including Dell Off-host BIOS Verification
BIOS Resilience
BIOS Recovery, and additional BIOS Controls
SafelD including Trusted Platform Module (TPM) 2.0
Self-Encrypting Drives (SED)
Smart card keyboard (FIPS)
D-Pedigree (Secure Supply Chain Functionality)
Dell wired mouse with fingerprinter reader

Environmental

The following table lists the environmental specifications of your OptiPlex 7400 All-in-One.

Table 25. Environmental

Feature	Values
Recyclable packaging	Yes
BFR/PVC—free chassis	No
Vertical orientation packaging support	Yes
Multi-Pack packaging	No

Table 25. Environmental (continued)

Feature	Values
Energy-Efficient Power Supply	Standard
ENV0424 compliant	Yes

NOTE: Wood-based fiber packaging contains a minimum of 35% recycled content by total weight of wood-based fiber. Packaging that contains without wood-based fiber can be claimed as Not Applicable. The anticipated required criteria for EPEAT 2018.

Regulatory compliance

The following table lists the regulatory compliance of your OptiPlex 7400 All-in-One.

Table 26. Regulatory compliance

Regulatory compliance
Product Safety, EMC and Environmental Datasheets
Dell Regulatory Compliance Home page
Dell and the Environment

Operating and storage environment

This table lists the operating and storage specifications of your OptiPlex 7400 All-in-One.

Airborne contaminant level: G1 as defined by ISA-S71.04-1985

Table 27. Computer environment

Description	Operating	Storage
Temperature range	10°C to 35°C (50°F to 95°F)	-40°C to 65°C (-40°F to 149°F)
Relative humidity (maximum)	20% to 80% (non-condensing)	5% to 95% (non-condensing)
Vibration (maximum)*	0.26 GRMS	1.37 GRMS
Shock (maximum)	110 G†	160 G†
Altitude range	-15.2 m to 3048 m (-49.87 ft to 10000 ft)	-15.2 m to 10668 m (-49.87 ft to 35000 ft)

CAUTION: Operating and storage temperature ranges may differ among components, so operating or storing the device outside these ranges may impact the performance of specific components.

* Measured using a random vibration spectrum that simulates user environment.



† Measured using a 2 ms half-sine pulse.

Getting help and contacting Dell

Self-help resources

You can get information and help on Dell products and services using these self-help resources:

Table 28. Self-help resources

Self-help resources	Resource location
Information about Dell products and services	www.dell.com
My Dell app	
Tips	
Contact Support	In Windows search, type <code>Contact Support</code> , and press Enter.
Online help for operating system	www.dell.com/support/windows www.dell.com/support/linux
Access top solutions, diagnostics, drivers and downloads, and learn more about your computer through videos, manuals and documents.	Your Dell computer is uniquely identified by a Service Tag or Express Service Code. To view relevant support resources for your Dell computer, enter the Service Tag or Express Service Code at www.dell.com/support . For more information on how to find the Service Tag for your computer, see Locate the Service Tag on your computer .
Dell knowledge base articles for a variety of computer concerns	<ol style="list-style-type: none"> 1. Go to www.dell.com/support. 2. On the menu bar at the top of the Support page, select Support > Knowledge Base. 3. In the Search field on the Knowledge Base page, type the keyword, topic, or model number, and then click or tap the search icon to view the related articles.

Contacting Dell

To contact Dell for sales, technical support, or customer service issues, see www.dell.com/contactdell.

 **NOTE:** Availability varies by country/region and product, and some services may not be available in your country/region.

 **NOTE:** If you do not have an active Internet connection, you can find contact information about your purchase invoice, packing slip, bill, or Dell product catalog.