



User Manual

- Please read this manual before operating this scanner.
- After you finish reading this manual, store it in a safe place for future reference.

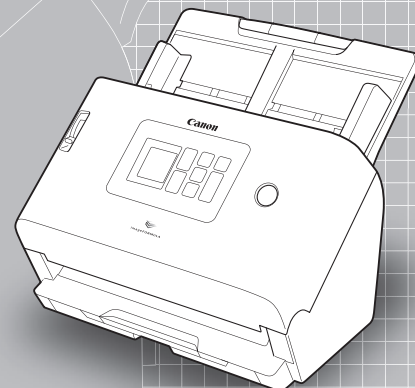

Table of Contents

Introduction	4	Scanning by Selecting a CaptureOnTouch Job from the Scanner	49
Symbols Used in This Manual	5	Creating a Job with CaptureOnTouch	49
Before Using the Scanner	6	Selecting a Job from the Scanner	50
System Requirements of Software.....	6	Scanning with a Job Registered in the Scanner (for Users)	51
Important Safety Instructions	7	Scanning with a Mopria-Compatible Device.....	52
Installation Location	7	Scanning with More Detailed Settings	53
AC Adapter.....	7	Setting the Long Document Mode.....	53
Moving the Scanner	8	Detecting a document double feed.....	53
Handling	8	Making settings	55
Disposal	9	Web Menu Operating Procedure.....	56
When sending the scanner for repairs	9	Screen Descriptions	56
Features of the Scanner	10	Displaying Administrator Settings.....	57
Names and Functions of Parts	13	Settings Menu Operating Procedure	58
Operation Panel	16	Example of Operating Each Screen	58
Basic Operation	20	Web Menu List.....	60
Power Supply	20	Administrator settings.....	60
Turning the Power ON	20	Others	60
Turning the Power OFF	21	Settings Menu List	61
Documents	22	Scan Settings	61
How to Place Documents	24	Device Configuration	61
Scanning multiple documents	24	Network Settings	61
When scanning a document one page at a time (Bypass mode)	26	COT Lite Web.....	61
Placing Cards.....	27	Version Information	61
Placing Folded Documents	28	Help	61
Scanning with Carrier Sheets.....	29	List of Purpose-by-Purpose Settings	62
Loading passports.....	30	Scanner Settings	63
Scanning.....	32	Setting the Language for Display	63
Scanning with a Smart Device.....	34	Setting an Area	64
Displaying the Web Menu	34	Checking/Resetting the Roller Feed Count	66
Scanning with CaptureOnTouch Lite Web	35	Setting the Time to Replace the Roller.....	67
Scanning with CaptureOnTouch	38	Checking/Resetting the Scan Count	68
Starting and Exiting CaptureOnTouch	38	Setting the Date and Time.....	69
Selecting a scanner.....	39	Making the Setting for Automatically Turning Off the Power	72
Screen Descriptions	40	Setting the Name for the Scanner	73
Standard Scanning.....	41	Setting the Buzzer	74
Scanning Shortcut.....	43	Initializing All Settings.....	75

Resetting Settings to the Factory Default State (Performing a Factory Reset)	76
Backing Up Settings (Web Menu Only)	77
Loading Backed Up Settings (Web Menu Only)	77
Restricting Functions (Web Menu Only)	78
Managing Icons (Web Menu Only)	78
Upgrading the Scanner (Web Menu Only)	79
Restricting the Data That Can Be Changed by General Users (Web Menu Only)	80
Acquiring a Scanner Log (Web Menu Only)	80
Temporarily Disabling Double Feed Detection (Settings Menu Only)	81
Temporarily Setting Passport Mode (Settings Menu Only) ..	81
Displaying Information about the Scanner	82
Network Settings	84
Setting an IP Address	84
Searching for the Scanner via the Network (Enabling mDNS)	86
Performing Management Using SNMP (Web Menu Only)	87
Make It Possible to Send Images by Email (Setting a Mail Server) (Web Menu Only)	92
Increasing the Security of an SFTP Connection (Setting a Secret Key) (Web Menu Only)	92
Managing Root Certificates (Web Menu Only)	93
Displaying Network Information	95
Security Settings	96
Using a PIN Code when Logging In	96
Installing an SSL Server Certificate (Web Menu Only)	99
Setting an Administrator Password	100
Web Menu Settings	101
Changing the Data to Be Displayed on the Display of the Scanner (Web Menu Only)	101
Setting CaptureOnTouch Lite Web (Web Menu Only)	102
Setting the COT Admin Server Function	103
Setting the COT Admin Server	103
Automatically Logging Out after Sending Scanned Images	105
Setting the Time for Automatic Logout	106
Registering a Job in the Scanner (for Administrators)	107
Creating/Editing/Registering Jobs in the Web Menu	107
Setting Items for Scan Mode	108
Setting Items for Output Mode	108

Other Setting Items	112
Maintenance	113
Daily Maintenance	113
Cleaning the Scanner	113
Cleaning the Display	113
Cleaning the Inside of the Scanner	113
Cleaning the Sensor Glass and the Rollers	113
Replacing Consumable Parts	116
Removing the Document Feed Tray	119
About the Canon imageFORMULA Driver Setting Tool	120
Troubleshooting	121
When in Trouble	121
Problems with the Scanner	121
Problems with Scanning	124
Problems with the Web Menu	137
Frequently Asked Questions	140
Questions about CaptureOnTouch	140
Questions about the scanner driver	141
Questions about the scanner	142
Clearing a Paper Jam	143
Error Message	145
Uninstalling the Software	148
Appendix	150
Specifications	150
Replacement parts	151
Option	151
About the Flatbed Scanner Unit	152
Dimensions	152
Regulations	153
Index	156

Introduction

Thank you for purchasing the Canon imageFORMULA Document Scanner.

Please read the following manuals carefully and familiarize yourself with the functions of the scanner before use to ensure you sufficiently understand the functions and make the most of the scanner's capabilities. After reading the manuals, store them in a safe place for future reference.

Manuals for the Scanner

Documentation for this scanner consists of the following manuals.

● Product Safety Guide

Before using the scanner, be sure to read and follow these instructions.

● Setup Guide

This describes setup procedures for the scanner. Read this manual when you first use the scanner.

● User Manual (this manual)

This manual contains the operating procedures of the scanner. (PDF electronic manual only)

Windows

If you are using Windows, the User Manual (electronic manual) will be registered to the following location when the software is installed.

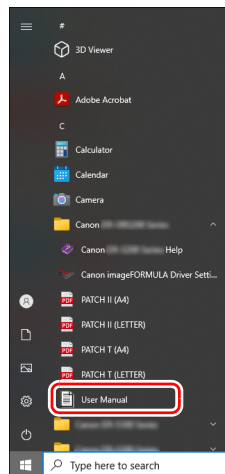

Mac

The User Manual (electronic manual) will be registered to the following location.

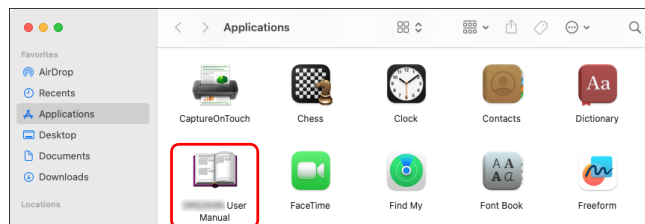

Symbols Used in This Manual

The following section explains the symbols and indications used in the manual for this scanner. Before you start reading the manual, take a moment to glance through it and familiarize yourself with their meanings.

WARNING

Indicates a warning concerning operations that may lead to death or injury to persons if not performed correctly. To use the scanner safely, always pay attention to these warnings.

CAUTION

Indicates a caution concerning operations that may lead to injury to persons, or damage to property if not performed correctly. To use the scanner safely, always pay attention to these cautions.

IMPORTANT

Indicates operational requirements and restrictions. Be sure to read these items carefully to operate the scanner correctly, and avoid damaging the scanner.

Hint

Indicates a clarification of an operation, or contains additional explanations for a procedure. Reading these notes is highly recommended.

System Requirements of Software

To use the scanner, your computer must satisfy the following system requirements.

Computer

CPU:	Intel Core i3 2.13GHz or faster Windows Intel Core i5 2.3GHz or faster Mac
Memory:	4 GB or more Windows 16 GB or more Mac
Hard disk:	10 GB or more available space required for installation of all software
USB interface:	USB 3.2 Gen1x1/ USB2.0
Monitor:	Resolution of 1024 × 768 (XGA) or better recommended.

Operating system

- Microsoft Windows 10 (32-bit and 64-bit editions)
- Microsoft Windows 11
- Microsoft Windows Server 2016
- Microsoft Windows Server 2019
- Microsoft Windows Server 2022
- macOS 11
- macOS 12
- macOS 13

This is the environment as of July 2023.

For the latest software support information, go to the Products page on the Canon website.

Other requirements

- An ISIS-compatible application or a TWAIN-compatible application that is compatible with the above operating systems.
- .NET Framework 4.6.2 or later

! IMPORTANT

- Use the USB interface provided as standard with your computer. However, normal operation is not guaranteed with all USB interfaces, even if present as standard equipment on the computer. For details, consult your local authorized Canon dealer.
- Scanning speeds are lower if your computer's standard USB interface is USB Full-Speed (equal to USB 1.1.)
- The USB cable you are using should be the one originally included with the scanner.
- If the CPU, memory, interface card, and other specifications do not satisfy the installation requirements, the scanning speed may be greatly reduced and transmission may take a long time.
- Even if the computer satisfies the system requirements, the scanning speed may vary, depending on the specification of the computer and the environment.
- The scanner drivers provided with the scanner do not necessarily operate on all ISIS or TWAIN-compatible applications. For details, contact your application software retailer.
- In Windows 10 tablet mode, the software may disrupt the display.

Precautions for Use in 64-bit Operating Systems (Windows only)

- The ISIS driver supplied with this product supports scanning with 32bit applications only.

Important Safety Instructions

To ensure the safe operation of this scanner, be sure to read the safety warnings and precautions described below.

Installation Location

The performance of this scanner is affected by the environment in which it is installed. Make sure that the location where the scanner is installed meets the following environmental requirements.

- Provide adequate space around the scanner for operation, maintenance, and ventilation.

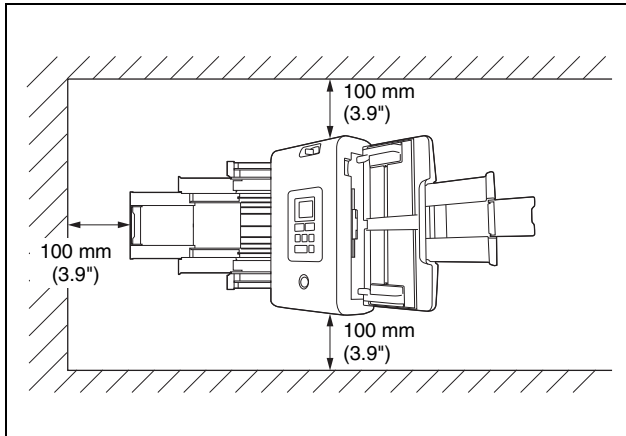

- Provide adequate space in front of the scanner for documents output after being scanned.
- Avoid installing the machine in direct sunlight. If this is unavoidable, use curtains to shade the scanner.
- Avoid locations where a considerable amount of dust accumulates as dust may adversely affect the inside of the scanner.
- Avoid warm or humid locations, such as in the vicinity of a water faucet, water heater, or humidifier. Avoid locations where ammonia gas is emitted. Avoid locations near volatile or flammable materials, such as alcohol or paint thinner.
- Avoid locations that are subject to vibration.

- Avoid exposing the scanner to rapid changes in temperature. If the room in which the scanner is installed is cold but rapidly heated, water droplets (condensation) may form inside the scanner. This may result in a noticeable degradation in scanning quality. The following conditions are recommended for optimal scanning quality:
Room temperature: 10 °C to 35 °C (50 °F to 95 °F)
Humidity: 20% to 80% RH
- Avoid installing the scanner near equipment that generates a magnetic field (e.g. speakers, televisions, or radios.)
- Do not block the ventilation holes. Doing so could cause the scanner to overheat, creating a fire hazard.

AC Adapter

- Connect only to a power outlet of the rated voltage and power supply frequency (120 V, 60 Hz or 220-240 V, 50/60 Hz depending on your region).
- Do not connect other electrical equipment to the same power outlet to which the scanner is connected. Also, when using an extension cord, make sure that the extension cord is rated for the current requirements of the scanner.
- Never try to take the AC adapter apart or modify it in any way, as this is dangerous.
- The power cord may become damaged if it is often stepped on or if heavy objects are placed on it.
- Do not use the power cord while it is coiled.
- Do not pull directly on the power cord. When disconnecting the power cord, grasp the plug and remove it from the outlet.
- Keep the area around the power cord clear of objects so that the power cord can be disconnected easily in an emergency.
- Do not use an AC adapter other than the one provided with the scanner. Do not use the AC adapter provided with the scanner with other products.
- If you have any questions regarding the power supply, contact your local authorized Canon dealer or service representative for further information.

Moving the Scanner

- When moving the scanner, always hold it with both hands to avoid dropping it.
- Make sure to disconnect the interface cable and AC adapter before moving the scanner. If the scanner is transported with these items connected, the plugs and connectors may be damaged.

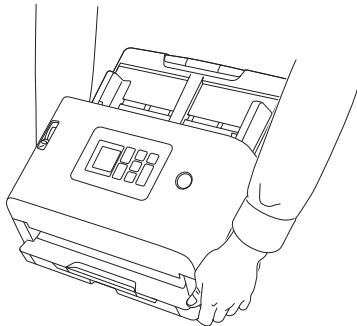

Handling

WARNING

Note the following precautions whenever using the scanner. Failure to do so may result in a fire or electric shock.

- Never use alcohol, benzene, paint thinner, aerosol sprays, or any other highly flammable substance near the scanner.
- Do not cut, damage, or modify the power cord. Do not place heavy objects on the power cord, and do not pull or excessively bend the power cord.
- Never connect the power cord when your hands are wet.
- Do not connect the scanner to a multi plug power strip.
- Do not knot or coil the power cord as this may result in a fire or electric shock. When connecting the power cord, make sure that the power plug is securely and completely inserted into the power outlet.

- The supplied power cord set is intended for use with this scanner only. Do not use it with other electronic equipment. In addition, do not use power cord sets other than the one supplied with the scanner. Doing so may result in fire or electric shock.
- Do not take the scanner apart or modify it.
- Never try to take the AC adapter apart or modify it in any way, as this is dangerous.
- Do not use flammable spray near the scanner.
- When cleaning the scanner, turn OFF the power and disconnect the power cord from the power supply.
- Clean the scanner using a slightly dampened cloth which has been well wrung out. Never use alcohol, benzene, paint thinner, or any other flammable substances.
- If the scanner makes strange noises, or gives off smoke, heat, or strange odors, or the scanner does not function or other abnormalities occur when you use the machine, immediately turn OFF the power, and disconnect the power plug from the power outlet. Then, contact your local authorized Canon dealer or service representative to have the unit serviced.
- Do not drop the scanner, or subject it to impact or strong shock. Should the scanner ever become damaged, immediately turn OFF the power, and disconnect the power plug from the power outlet. Then, contact your local authorized Canon dealer or service representative to have the unit serviced.
- Before moving the scanner, be sure to turn OFF the power, and disconnect the power plug from the power outlet

CAUTION

- Do not install the scanner on a surface that is unstable or tilted, or in an area subject to excessive vibrations, as this may cause the scanner to fall, resulting in personal injury or damage to the scanner.
- Never place small metal objects such as staples, paper clips, or jewelry on the scanner. These items may fall into the scanner, and cause a fire or electric shock. Should such objects ever fall inside the scanner, immediately turn OFF the power, and disconnect the power plug from the power outlet. Then, contact your local authorized Canon dealer or service representative to have the unit serviced.
- Do not install the scanner in a humid or dusty location. Doing so might cause a fire or electric shock.

-
- Do not place objects on top of the scanner. Such objects may tip or fall over, resulting in personal injury.
 - Connect only to a power outlet of the rated voltage and power supply frequency (120 V, 60 Hz or 220-240 V, 50/60 Hz depending on your region). Doing so might cause a fire or electric shock.
 - When unplugging the power cord, grasp it firmly by its plug. Do not pull directly on the power cord, as this may damage or expose the cord's internal wiring, resulting in a fire or electric shock.
 - Leave sufficient space around the power plug so that it can be unplugged easily. If objects are placed around the power plug, you will be unable to unplug it in an emergency.
 - Do not allow water or flammable substances (alcohol, paint thinner, benzene, etc.) to spill into the scanner, as this may result in a fire or electric shock. Doing so might cause a fire or electric shock.
 - Turn OFF the power for safety when not using the scanner for a long period of time, such as overnight. Also, turn OFF the power and disconnect the power cord from the power outlet for safety when the machine will not be used for an extended period of time, such as during consecutive holidays.
 - Do not wear loose clothing or jewelry that may get caught in the scanner while you are using it, as this may result in personal injury. Be extra careful of neckties and long hair. If anything becomes caught in the scanner, immediately disconnect the power cord to stop the scanner.
 - Be careful when loading paper into the scanner and when removing jammed paper, as it is possible to cut your hand on the edge of a sheet of paper.

Disposal

When disposing of this scanner, be sure to follow all local ordinances and laws or consult with the retailer who sold you the scanner. Before disposal, refer to [“Initializing All Settings” \(See p. 75\)](#) or [“Resetting Settings to the Factory Default State \(Performing a Factory Reset\)” \(See p. 76\)](#) to erase the data inside the scanner.

When sending the scanner for repairs

When a request is made for repairs, the scanner needs to be sent to the specified address. When sending the scanner, use the packing box in which it came. Firmly secure the scanner with packaging material when you place it in the packing box.

Features of the Scanner

The main features of the scanner are described below.

Scanner Features

- **CaptureOnTouch Lite Web Function Ready to Use Right Out of the Box**

General document scanners require the installation of scanner drivers and scanning applications on your computer before use. The DR-S250N has software installed in the scanner itself and is equipped with the CaptureOnTouch Lite Web function, which allows you to scan without installing any applications on your computer or smart device.

Just connect the scanner to the same network as that of your computer or smart device, and you can start scanning immediately without installing anything. It allows easy scanning in new work styles, including branch offices, business trips, and coworking spaces.

- **Connection Modes That Can Be Selected According to the Usage Environment**

You can use the scanner with both wired LAN and USB connections.

If you use it with a LAN connection, you can easily share the scanner among multiple computers on the network. It also supports IPv6, allowing it to be used in various office environments.

- **Display Allowing for Intuitive Operation**

It has a display that allows for intuitive operation and clearly shows solutions in case of errors.

- **Registration of Scan Settings in the Scanner**

You can register frequently used scan/destination settings in the scanner. Even without a computer or smart device, you can complete everything from scanning to transmission.

Even with registered jobs, you can temporarily change the settings and scan.

Even with jobs that normally scan in monochrome, you can perform operations flexibly, such as scanning in color only when there are color pen entries and turning OFF ultrasonic double feed detection only when an envelope is mixed in the batch of documents.

- **Secure Operation Management**

You can restrict non-administrator users from changing settings. You can set whether to restrict users for each function.

- **Support of a Variety of Documents**

You can scan a wide range of document types, from small sizes like business cards and receipts to A4-sized documents, passports, long documents, and cards. In addition, when using “Folio mode”, you can scan documents up to a maximum size of A2. It also supports long documents, allowing you to scan documents up to a maximum of 5,588 mm (220 inches).

- **Full Auto Mode**

A Full Auto Mode is provided in CaptureOnTouch and the scanner driver to allow scanning under automatically determined conditions. Scanning conditions such as the color mode and page size are set automatically based on the document being scanned.

- **Presets**

Settings suitable for passports and documents with photos are prepared in advance as presets. In addition, users can also register their preferred settings.

- **Support of Various Destinations**

Data transmission according to the application, such as email and FTP, is possible. You can directly send data to Teams or Slack with the email function.

- **Environmentally Friendly Energy-Saving Design**

The design is energy-saving, consuming up to 22 W during operation and 1.6 W in sleep mode.

- **Mopria Certification (Universal Scan)**

You can easily scan from Mopria-compatible devices or operating systems (such as ChromeOS and Android).

Detection Functions

● Auto Resolution Detection

When enabled in the CaptureOnTouch or scanner driver settings, this function detects the content of documents and determines the scanning resolution automatically. It can optimize the file size.

● Auto Color Detection

Automatically detects whether scanned documents are color, grayscale, or black and white.

● Paper Size Detection

Detects the size of the scanned document and creates an image without margins.

● Content Skew Correction

Even if the print on the document is skewed, it is corrected to be straight.

● Character Emphasis

You can adjust the thickness of characters and lines, improving the OCR processing accuracy for characters with thin lines.

● Ultrasonic Double Feed Detection

The scanner stops feeding when the ultrasonic sensor detects that two or more document pages are feeding at the same time.

● Text Orientation Detection

The text orientation on each page is detected, and the scanned image is rotated in 90-degree increments as necessary for normalization.

● Text Enhancement Modes

The scanner is equipped with three functions to improve the visibility and OCR processing accuracy of documents with low character visibility.

- Advanced Text Enhancement mode **Windows** : Makes documents with a dark background or uneven background easier to read.
- Advanced Text Enhancement II mode: Makes it easier to read characters on documents with a uniform background and faint characters and background.

- Active Threshold mode: Can batch process various types of documents, such as documents with faint characters or stains, at once.

* These modes may not work, depending on the type of document.

Image Processing Functions

● Color Emphasis Function

Creates a black and white or grayscale image that emphasizes a specific color (red, blue, or green) or a chromatic color. This is useful when you want to emphasize notes written with a marker or a faint imprint. You can specify only one color when specifying a specific color, but if you select a chromatic color, it can handle multiple colors in the document or different colors in each document.

● Color Drop-Out Function

Creates a black and white or grayscale image that removes a specific color (red, blue, or green) or a chromatic color. This is convenient when you want to scan ledgers or other documents with colored ruled lines.

● Document with Photo Mode

When you scan a document with both photos and characters, this mode can maintain high reproduction of both characters and photos. It can beautifully scan application forms with a face photo attached, for example.

● Folio Scan and Front/Back Combination Function

Documents that are too large to fit in the feeder inlet can be folded and scanned on both sides, with the images then combined into a single image.

The method for combining images can also be set, so that you can also combine the front and back of the document. You can combine the front and back of a card or postcard placed horizontally to create a single easy-to-view image.

● Noise Reduction

Reduces the noise in the image, making it easier to see and also allowing you to output images with a restrained file size.

- **MultiStream** [Windows](#)

With applications that support the scanner's MultiStream capability, three images with different scanning conditions are created from a single scan pass. However, this function is only available when using software that supports MultiStream.

- **Barcode Detection** [Windows](#)

Can detect barcodes within the document. Also, by using CaptureOnTouch, you can detect barcodes/2D codes included in the document and split the file.

- **Patchcode Detection** [Windows](#)

Patchcode sheets can be inserted in the document stack to perform batch separation.

- **1200 dpi Support**

Supports output up to 1200 dpi.

* 1200 dpi images are generated from 600 dpi ones.

Other requirements

- **Auto Start**

The scanner is equipped with an auto start function, which enables scanning to be automatically started when a document placed in the feeder is detected.

- **Sleep Mode**

The scanner is designed to save energy by automatically entering the sleep mode if 10 minutes elapse without scanning or another operation being performed.

- **A4/LEGAL Carrier Sheet Support**

Use the separately sold carrier sheet (A4 or LEGAL), you can scan without damaging the original.

- **Passport/Booklet Support**

Supports separately sold carrier sheets (for passports). You can also scan passports and booklets.

- **Data Erasure Function**

Performing a factory reset ([See p. 76](#)) erases all data inside the scanner and resets it to the factory default state.

- **COT Admin** [Windows](#)

This is a server application that can be used for centralized management of jobs/scanners/users. User authentication functions in the scanner and logon functions using NFC become available. For details of COT Admin, refer to the "COT Admin Server User Manual".

- **Canon DR Scanner Management Tool** [Windows](#)

This is a server application that can be used for centralized management of scanners. You can manage consumables, error status, firmware versions, etc. collectively. Even for scanners used with a USB connection, they can be managed by installing agent software on the computer.

Names and Functions of Parts

Front View (With the Document Eject Tray Closed)

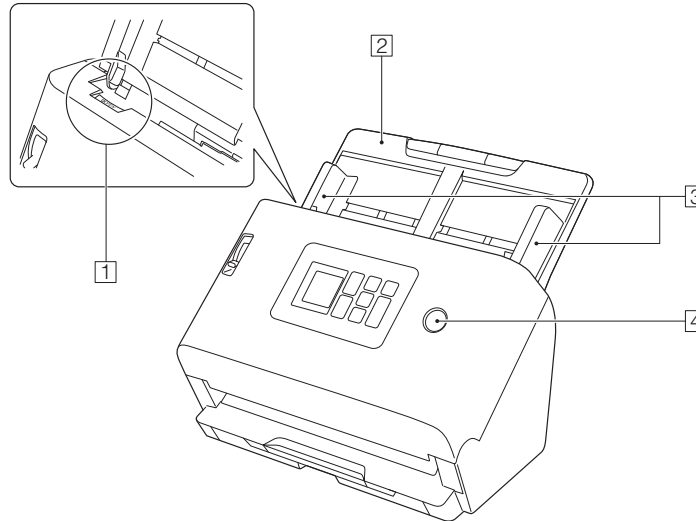

1 OPEN Lever

Pull this toward you to open the front unit.

2 Document Feed Tray

Place the document.

3 Document Guides

Align the document guides with both edges of the document to ensure that the document feeds straightly.

4 Power button

Press this to turn on the scanner. When pressed, the power indicator is lit.

To turn off the scanner, long press this button (for two seconds or longer).

The power button lights or flashes as follows depending on the scanner status.

Power Button Indication	Description
Lit	<ul style="list-style-type: none">• Power is on• An error (paper jam, front unit is open, double feed, etc.) has occurred
Flashing (slowly)	Sleep mode
Flashing (quickly)	A factory reset is in progress.

Front View (With the Document Eject Tray Open)

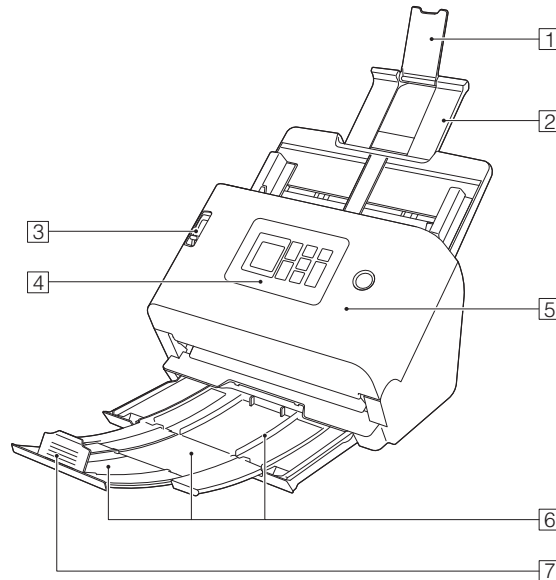

1 Feed Extension Support

Open this when placing long paper in the scanner.

2 Feed Support

Pull this out to support loaded documents.

3 Feed Selection Lever

Use this lever to change the way documents are fed.

Push it down to feed scan documents one at a time (Normal mode).
(See p. 24)

Push it up to feed scan documents that are fastened together, such as invoices, without separating them (Bypass mode). (See p. 26)

4 Operation Panel (See p. 16)

5 Front Unit

Open this when cleaning the inside of the scanner or replacing rollers.

6 Document Eject Tray

Pull this out to scan documents. Scanned documents are output here.

When scanning multiple documents of varying sizes at one time, pulling out and lifting up this tray locks the angle of the tray, so the documents ejected onto the tray are aligned.

7 Document Eject Stopper

This prevents the ejected document coming out of the document eject tray and aligns the leading edge of the document. It can be moved to any position on the document eject tray to match the length of the document.

Back View

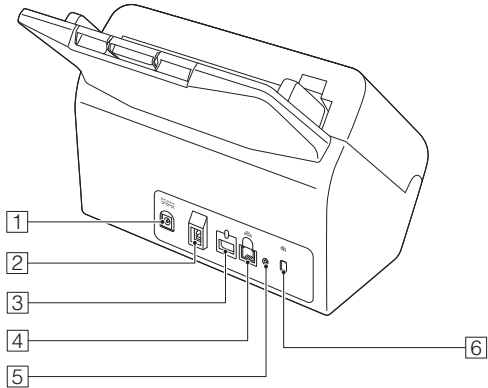

1 Power Connector

Connect the supplied AC adapter to this connector.

2 USB Connector

Connect the supplied USB cable to this connector.

3 Connector for Options

This can be used if you purchase options (such as an NFC reader). Sealed with a sticker when the scanner is purchased. Remove the sticker when using options.

4 LAN Connector

Connect a network cable that supports RJ-45 (10Base-T/100Base-TX/1000Base-T).

5 Factory Reset Button

This is used when you want to reset all settings and firmware versions to the factory default state (perform a factory reset).

6 Theft Prevention Hole (Security Slot)

Connect an anti-theft key chain or the like.

Operation Panel

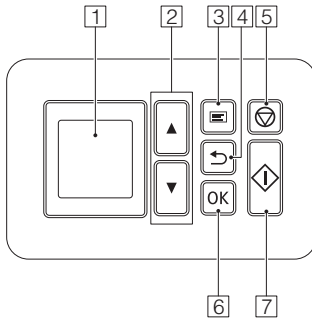

- 1 Display**
Displays jobs, messages, counters, etc.
- 2 ▲▼ Keys**
Used to select a job and the settings menu.
- 3 Menu Key**
Displays the settings menu. (See p. 55)
- 4 Back Key**
Returns you to the previous screen.
- 5 Stop Key**
Stops the scan under execution.
- 6 OK Key**
Used to confirm the selection.
- 7 Start Key**
Starts scanning documents.

Indication Examples on the Display

Data that appears on the display differs depending on the state of the scanner.

A typical example of a screen is shown below.

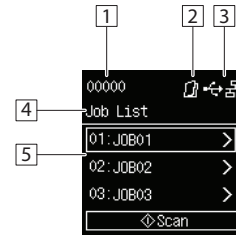





- 1 Display Count Area**
Displays the number of sheets of the document scanned.
- 2 Feed Method Display Area**
Displays the document feed method.
Switch the feed method with the feed switching lever of the scanner. (See p. 24, p. 26)

Indication	Description
No indication	Normal feed
	Bypass mode

3 Connection Mode Area

Displays the method of connecting the scanner to the computer.

Indication	Description
	Connected via USB.
	Connected via wired LAN.
	Not connected to the computer.
	Connected both via USB and wired LAN.

4 Title Area

Displays the title of the operating screen.

5 Comment Area

Displays selectable menu items and job items, error messages, etc.

Job Screen



Jobs on USB

Displays the jobs registered in CaptureOnTouch on the computer connected to the scanner via USB.

For details of how to scan using these jobs, refer to [“Scanning by Selecting a CaptureOnTouch Job from the Scanner”](#) (See p. 49).

Jobs on Scanner

Displays the jobs registered in the scanner.

For details of how to register jobs in the scanner, refer to [“Registering a Job in the Scanner \(for Administrators\)”](#) (See p. 107).

For details of how to perform scan registration using jobs registered in the scanner, refer to [“Scanning with a Job Registered in the Scanner \(for Users\)”](#) (See p. 51).

Jobs on <Computer Name>

Displays the jobs registered in CaptureOnTouch on the computer connected to the scanner via wired LAN.



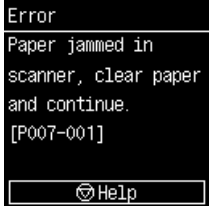

For details of how to scan using these jobs, refer to [“Scanning by Selecting a CaptureOnTouch Job from the Scanner”](#) (See p. 49).

■ Message Screen



Displays the status of the scanner. When an error occurs, the description of the error and the error code are displayed.

Depending on the screen, icons representing keys on the scanner are displayed.

Indication	Description
	OK Key
	Start Key
	Stop Key
	Menu Key

■ Help Screen

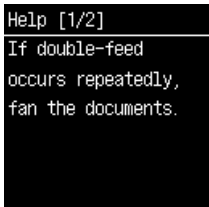

On the screen displaying [Help], pressing the Stop key displays help text.

■ PIN Code Input Screen



When the PIN function is enabled, entry of a PIN is required when the scanner is turned on. For details of whether the PIN function is enabled or disabled, refer to [“Using a PIN Code when Logging In” \(See p. 96\)](#).

Key to operate	Description
▲▼ Keys	Used to change the value at the cursor position.
OK Key	Used to confirm the value at the cursor position. Used to move the cursor to the right. If the cursor is at the right end position, sets the data in the scanner.
Back Key	Used to move the cursor to the left.

■ Screen Displayed When COT Admin Mode Is Enabled

If COT Admin mode is enabled, the following screens may be displayed depending on the authentication settings of COT Admin.

Key to operate	Description
▲▼ Keys	Used to change the value at the cursor position.
OK Key	Used to confirm the value at the cursor position. Used to move the cursor to the right. If the cursor is at the right end position, sets the data in the scanner.
Back Key	Used to move the cursor to the left.
Menu Key	Used to switch upper-case characters, lower-case characters, numeric values, and symbols.
Start Key	Used to set the entered data in the scanner.

Power Supply

Turning the Power ON

The power of the scanner can be turned ON and OFF with the power button on the front of the scanner.

- 1 Make sure that the scanner and computer are connected properly.
- 2 Press the power button.

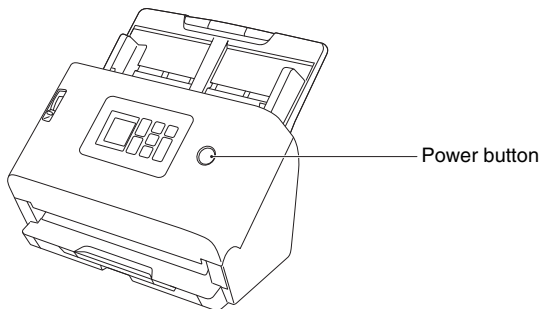



The power button lights blue when the power turns ON.

Windows

Hint

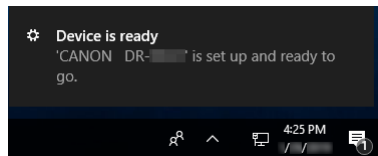
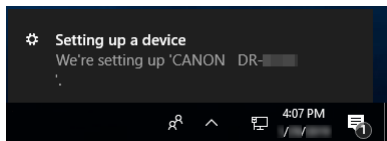
When connected via USB, a balloon message such as shown below appears on the task bar. If you wait a while, automatic scanner recognition will end and the scanner will become ready to use.



When the scanner is properly connected to the computer, the  (CaptureOnTouch) icon appears on the taskbar as follows.



If the taskbar icon appears as , the scanner is not properly connected to the computer. Check the status of the power supply and USB cable.

Mac

When the scanner is properly connected to the computer, the  (CaptureOnTouch) icon appears on the taskbar as follows.



If the taskbar icon appears as , the scanner is not properly connected to the computer. Check the status of the power supply and USB cable.

Turning the Power OFF

When you press and hold the power button two seconds or longer, the scanner turns off.

IMPORTANT

- Except for emergencies, do not disconnect the power cord to turn the power off.
- When turning on the scanner after it turns off, wait at least 10 seconds before turning it back on.
- If you will not be using the scanner for an extended period, turn off the power and disconnect the power cord from the AC outlet for safety.

Hint

The scanner's auto power off setting is enabled by default, and the scanner will turn off automatically if it is not operated for 4 hours.

For information on disabling this setting, refer to ["Making the Setting for Automatically Turning Off the Power"](#) (See p. 72).

Documents

The scanner can scan documents ranging in size from business cards to A4/LTR. The document sizes that this scanner can scan are shown below.

Plain Paper

Size

Width: 50.8 mm to 216 mm (2" to 8.5")

Length: 54 mm to 356 mm (2.1" to 14") (You can scan documents up to 5,588 mm (220") long by setting the scanner to the Long Document mode.)

Paper thickness

Normal feed: 27 to 209 g/m² (7 to 56 lb bond) 0.04 mm to 0.25 mm (0.00157" to 0.00984")

Non separation feed: 27 to 255 g/m² (7 to 68 lb bond) 0.04 mm to 0.3 mm (0.00157" to 0.0118")

Loading capacity

A4 size or smaller: 60 sheets (80 g/m² (22 lb bond))

Larger than A4 size: 40 sheets (80 g/m² (22 lb bond))

Make sure stacks do not exceed 6 mm in height for either of the above.

! IMPORTANT

The documents to be scanned must satisfy certain criteria. Read the following items carefully.

- When scanning multiple documents of different sizes, place the documents so that they cover the entire span of the feed rollers by aligning the centers and leading edges of the documents.

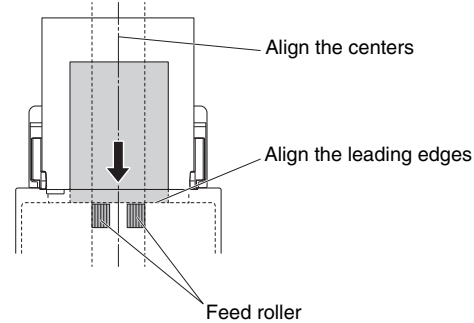

- It is recommended that documents exceeding 356 mm (14") size are fed one sheet at a time.
- Scanning documents before the ink is dry can cause problems with the scanner. Always make sure that the ink on a document is dry before scanning it.
- Scanning documents that are written in pencil or similar material may make the rollers and scanning glass dirty, which can lead to smudges on the scanned image and transfer the dirt to subsequent documents. Always clean the internal parts of the scanner after scanning such documents.
- When scanning a two-sided document that is printed on thin paper, the image on the opposite side of each page may show through. In this case, adjust the scanning intensity in the application software before scanning the document.
- Laminated documents may not be scanned correctly, depending on the document.

- Scanning the following types of documents can cause a paper jam or malfunction. To scan such a document, make a photocopy of the document and then scan the photocopy.



There are creases or fold lines.



Carbon paper



There are curls.



The surface is coated.



There are tears.



Extremely thin document such as semi-transparent thin paper.



There are clips or staples.



Documents with excessive paper dust particles.

Business Card

Size

Width: 50 mm to 55 mm (2" to 2.2")

Length: 85 mm to 91 mm (3.3" to 3.6")

Paper thickness 128 to 255 g/m² (34 to 67.8 lb bond) 0.15 mm to 0.3 mm (0.00591" to 0.0118")

Orientation: Vertical feeding only

! IMPORTANT

If a stack of business cards cannot be fed properly, reduce the number of cards in the stack.

Card (plastic)

Size 86 mm x 54 mm (3.37" x 2.12") (ISO standard)

Card thickness: 1.4 mm (0.055") or smaller

Orientation: Horizontal feeding only

Embossed Possible

Loading capacity 3 cards (non-embossed), 1 card (embossed)

! CAUTION

- When scanning cards, place them to be fed horizontally. If you place cards to be fed vertically, they may not be ejected properly because load is applied to them. In addition, cards that get jammed may be damaged when you remove them.
- Embossed cards may not be able to be scanned correctly, depending on the type of embossment.

- When scanning cards, make the following setting on the scanner driver settings screen.

– For Windows: Uncheck [Detect by Ultrasonic] on the [Error Detection] tab.

– For macOS: Uncheck [Double Feed Detection] or set the detection method to [Detect by Length].

For details, refer to the Help of the scanner driver.

Passport

Size 88 mm x 125 mm (3.464" x 4.921") (ISO standard)

Paper thickness 4 mm (0.157") or less (including carrier sheet)

When scanning the passport, open the passport and insert it in the separately sold carrier sheet before feeding.

How to Place Documents

Scanning multiple documents

Standard paper feeding should be used when scanning multiple documents of a standard size at one time. Standard paper feeding enables multiple documents to be fed while separating each page.

1 Pull out the document eject tray.

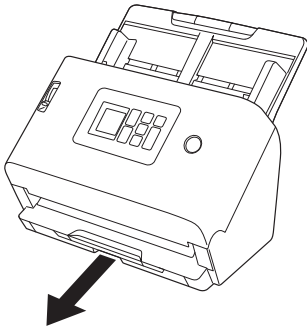

The document eject tray can be adjusted to 3 lengths. Pull out the document eject tray according to the length of the document. Also, erect the document eject stopper on the front edge if necessary.

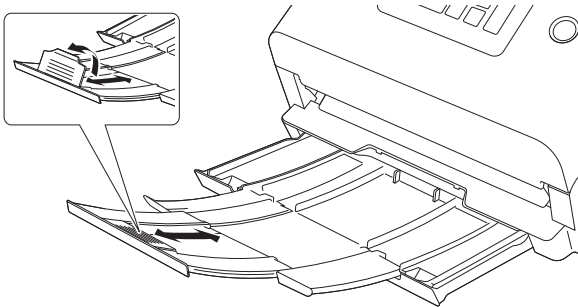

! IMPORTANT

Pull the document eject tray forward according to the various lengths.

💡 Hint

When scanning multiple documents of varying sizes at one time, pulling out and lifting up the document eject tray locks the angle of the tray, so the documents ejected onto the tray are aligned.

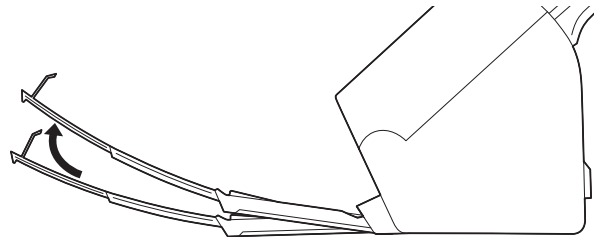

2 Pull out the feed support.

Open the feed extension support when placing long documents.

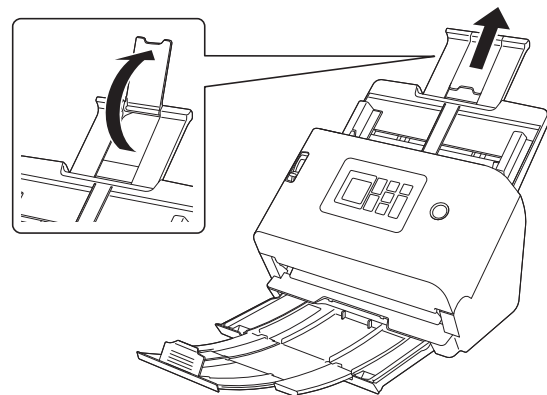

3 Set the feed selection lever to Normal mode.

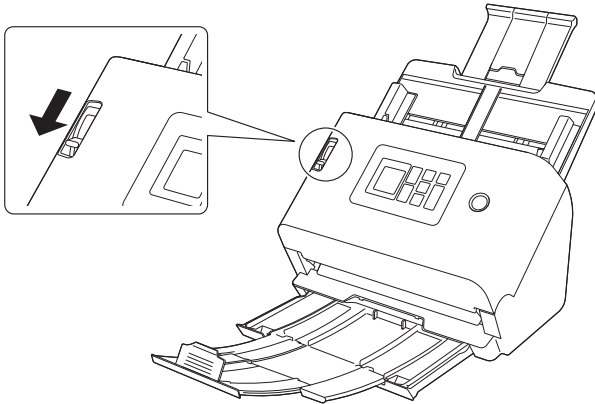

4 Open the document guides wider than the width of the document you are going to scan.

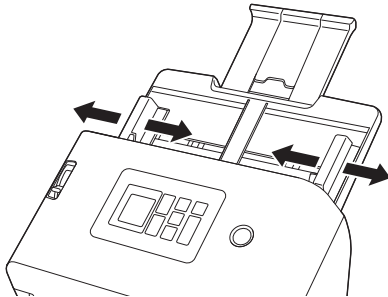

5 Place the document.

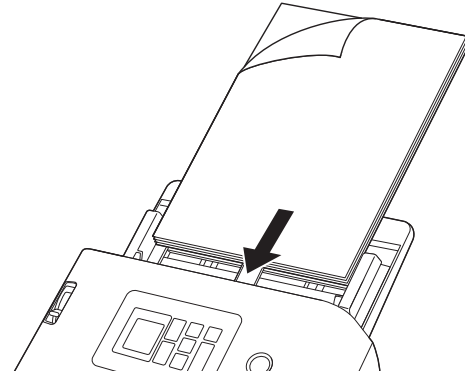

6 Align the document guides with both edges of the document.

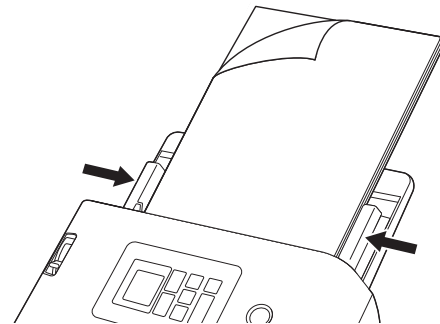

! IMPORTANT

- Handle the document carefully when placing it. Take care not to cut your hand on the edges of the paper.
- Before you place a document, check to make sure it does not contain paper clips, staples, or other small metal objects. These items may cause a fire or electrical shock, damage the document, or cause a paper jam or scanner malfunction.

- Do not wear loose clothing or jewelry that may get caught in the scanner while you are using it, as this may result in personal injury. Be extra careful of neckties and long hair. If anything gets caught in the scanner, immediately turn OFF the power, and disconnect the power cord from the power outlet to stop scanning.
- Always smooth out any folds or curls in your documents before placing them into the feeder. If the leading edge of a document is curled, it may cause a paper jam.
- If feeding stops due to a system error or paper jam while the scanner is scanning, resolve the problem, make sure that the scanned image of the last page that was successfully fed has been stored, and then resume scanning the remaining document pages.
- After you finish scanning, close the document eject tray and the feed support to prevent damage to the scanner while it is not being used.

When scanning a document one page at a time (Bypass mode)

When scanning a thick document one page at a time or scanning a document that has multiple pages fastened together, set the feed selection lever to Bypass mode. This enables the placed document to be scanned without the pages being separated, regardless of the number of pages.

1 Set the feed selection lever to Bypass mode.

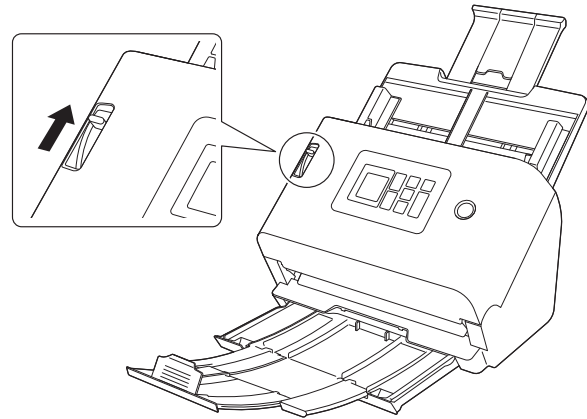

2 Place the document as described in the “Scanning multiple documents” (See p. 24).

! IMPORTANT

- When scanning multiple page documents that are fastened together, such as invoices, place the documents so that the edge that is fastened together is facing down.
- When a double feed occurs, refer to “A document double feed occurs.” (See p. 126) and “A plastic card, envelope, or booklet is detected erroneously as a double feed.” (See p. 126) in “When in Trouble”.

Placing Cards

Depending on whether the cards have a bumpy surface, the way to place the cards may differ.

CAUTION

- When scanning cards, place them to be fed horizontally. If you place cards to be fed vertically, they may not be ejected properly because load is applied to them. In addition, cards that get jammed may be damaged when you remove them.

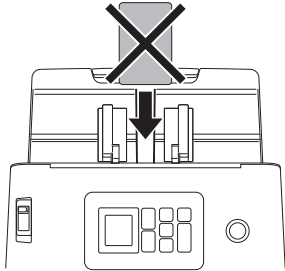

- When scanning cards, make the following setting on the scanner driver settings screen.
 - For Windows: Uncheck [Detect by Ultrasonic] on the [Error Detection] tab.
 - For macOS: Uncheck [Double Feed Detection] or set the detection method to [Detect by Length].For details, refer to the Help of the scanner driver.

In the case of cards with a bumpy surface (that have been embossed)

When scanning cards that have been embossed, set the feed selection lever to Bypass mode and then place one card at a time in the scanner horizontally.

1 Set the feed selection lever to Bypass mode.

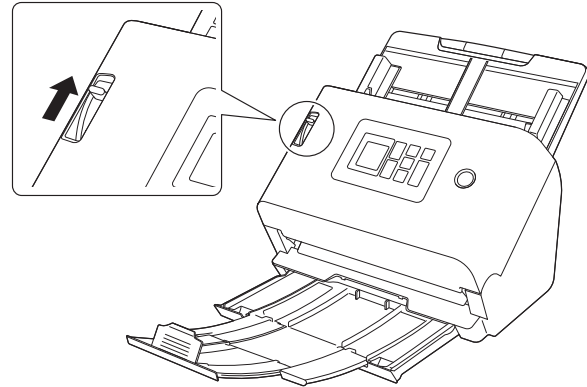

2 Adjust the document guides to fit the width of the card to be scanned.

3 Place the card horizontally, with the reverse side facing you, and the top of the card facing down.

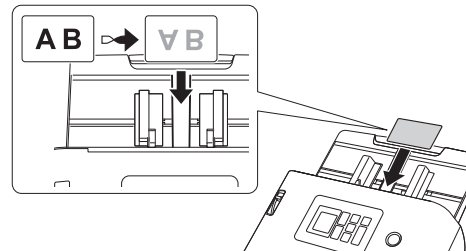

CAUTION

Place the cards one at a time.

In the case of cards without a bumpy surface (that have not been embossed)

When scanning cards that have not been embossed, place the cards horizontally in the scanner.

- 1 Adjust the document guides to fit the width of the card to be scanned.**
- 2 Place the card horizontally, with the reverse side facing you, and the top of the card facing down.**

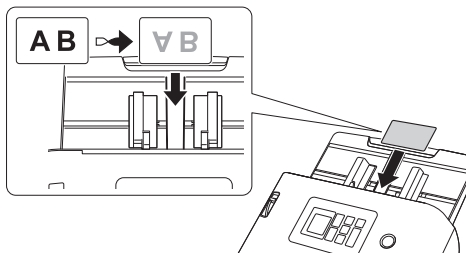

Hint

Up to 3 cards can be placed in the scanner at the same time if they are not embossed.

Placing Folded Documents

Folio Scan enables you to scan documents that are larger than A4/LTR and therefore do not fit in the feeder. To use the function, fold the document in half lengthwise and place it into the feeder. The scanner will scan both sides and combine the scanned images into a single image.

- 1 Set the feed selection lever to Bypass mode.**

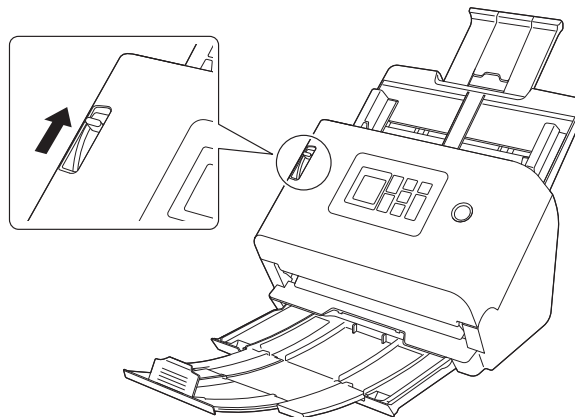

- 2 Fold the document in half.**

Crease the document firmly down its center to fold the document in half. Fold the document so that its edges are neatly aligned. If the document is not folded properly, paper jams may occur or distortions may appear in the combined scanned image.

IMPORTANT

A portion of the scanned image will be missing at the fold line.

- 3** Place the document with the folded edge facing right and the top edge facing downward.

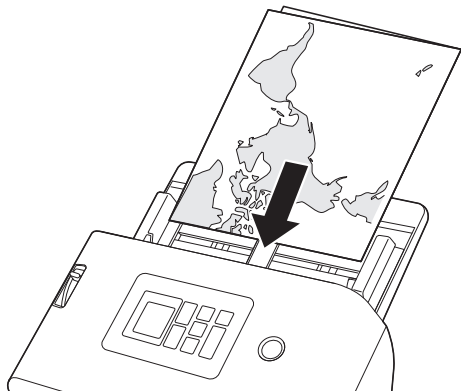

! IMPORTANT

Adjust the document guides to fit the width of the document. Otherwise, the image may scan as skewed or shifted.

💡 Hint

- You can set how to combine the front and the back according to how the document is folded. For details, refer to the Help of the scanner driver.
- The maximum size for the combined image is A2. Use this method to scan A2-sized documents.
- Set [Page Size] to half the size of the paper you are actually going to scan on the scanner driver settings screen. When scanning a folded document of a size other than the standard format, set [Page Size] to [Match original size] (Windows)/ [Detect automatically] (macOS). For details, refer to the Help of the scanner driver.

Scanning with Carrier Sheets

To prevent damage to a document while scanning it, insert it into an optional carrier sheet before loading it in the scanner.

- 1** Set the feed selection lever to Bypass mode.

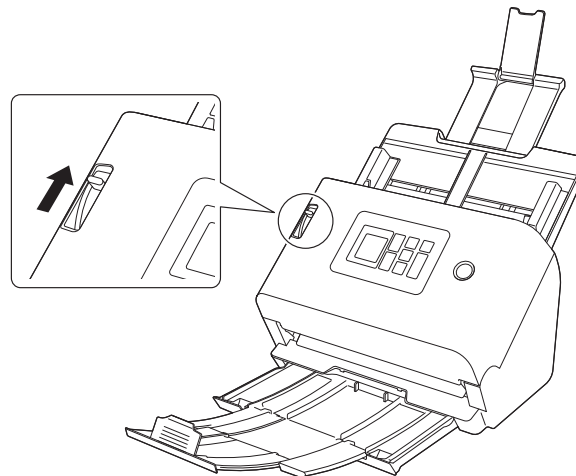

⚠ CAUTION

When scanning with a carrier sheet, make sure to set the Feed Selection Lever to Bypass Mode.

- 2** Insert the document into the carrier sheet.

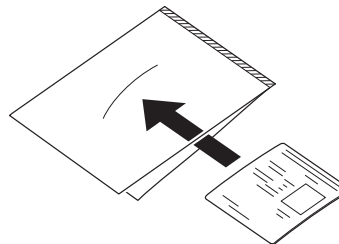

3 Load the document with the sealed end of the carrier sheet as the leading edge.

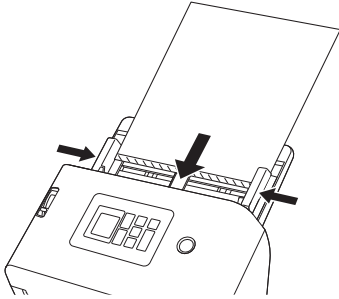

After placing the document, align the document guides with both edges of the document.

⚠ CAUTION

If the document is not placed properly inside the carrier sheet, you may get a document jam or not get a scan image as intended.

! IMPORTANT

- Insert documents straight into the center of the carrier sheet. Proper scanning will not be possible if the document is too close to either side, tilted, or protruding from the carrier sheet.

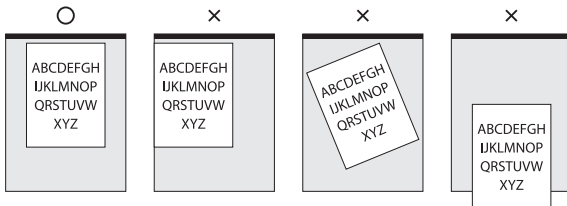

- When using a carrier sheet (LEGAL), set the long document mode of the scanner driver to [Long Document Mode (1000 mm)]. (See p. 53)

- The maximum thickness that can be scanned is 127 g/m². If the thickness exceeds 127 g/m², the scanner may break down due to problems such as paper jam.
- As a rough guide, replace the carrier sheet after 1,000 scanning operations with a single 80 g/m² (22 lb bond) sheet inserted. Carrier sheet is a consumable item. Replace it with a new one when necessary, if there is visible damage or smudging or if a paper jam occurs.

Loading passports

To scan a passport, insert the passport into the separately sold carrier sheet (for passports) and then place it onto the scanner.

1 Set the feed selection lever to Bypass mode.

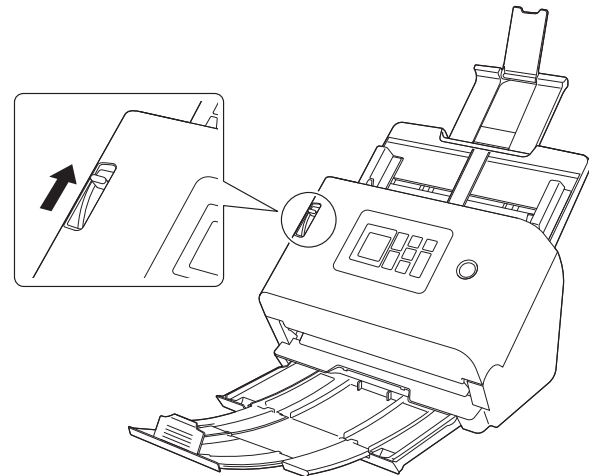

⚠ CAUTION

When scanning passports, make sure to set the Feed Selection Lever to Bypass Mode.

-
- 2** Open the page of the passport that you want to scan. Insert the passport into the carrier sheet so that the thicker side is positioned as close as possible to the sealed end.

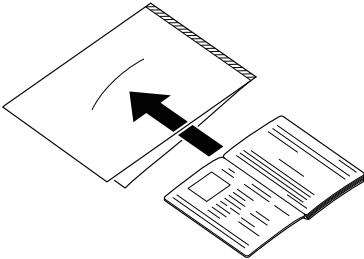

-
- 3** Load the document with the sealed end of the carrier sheet as the leading edge and the page you want to scan facing down.

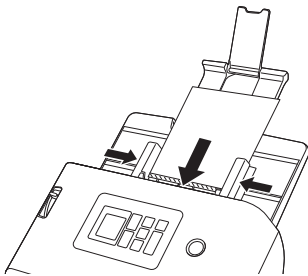

After placing the document, align the document guides with both edges of the document.

⚠ CAUTION

If the carrier sheet or passport is not loaded properly, you may get a document jam or not get a scan image as intended.

! IMPORTANT

- Depending on the condition of the carrier sheet or passport, the image may not be scanned completely or the scanner's image correction may not function properly. If this is the case, set [Page Size] to a larger paper size (A4, for example) on the scanner driver settings screen, and then scan again. For details, refer to the Help of the scanner driver.
- If the size of the passport differs greatly from the size of the carrier sheet, a document jam may occur or the scanner's image correction may not function properly.
- When scanning passports, set [Dots per inch] to 300 dpi or less on the scanner driver settings screen. For details, refer to the Help of the scanner driver.
- The maximum thickness that can be scanned is 4 mm with the passport inserted inside the carrier sheet. If the thickness exceeds 4 mm, the scanner may break down due to problems such as paper jam.
- Depending on the thickness and condition of the passport or booklet you put in the carrier sheet, the image may become distorted.
- Carrier sheet is a consumable item. Replace it with a new one when necessary, if there is visible damage or smudging.

Scanning

You can scan in various ways with this scanner. Here are recommended scanning methods suitable for your scanner and environment.

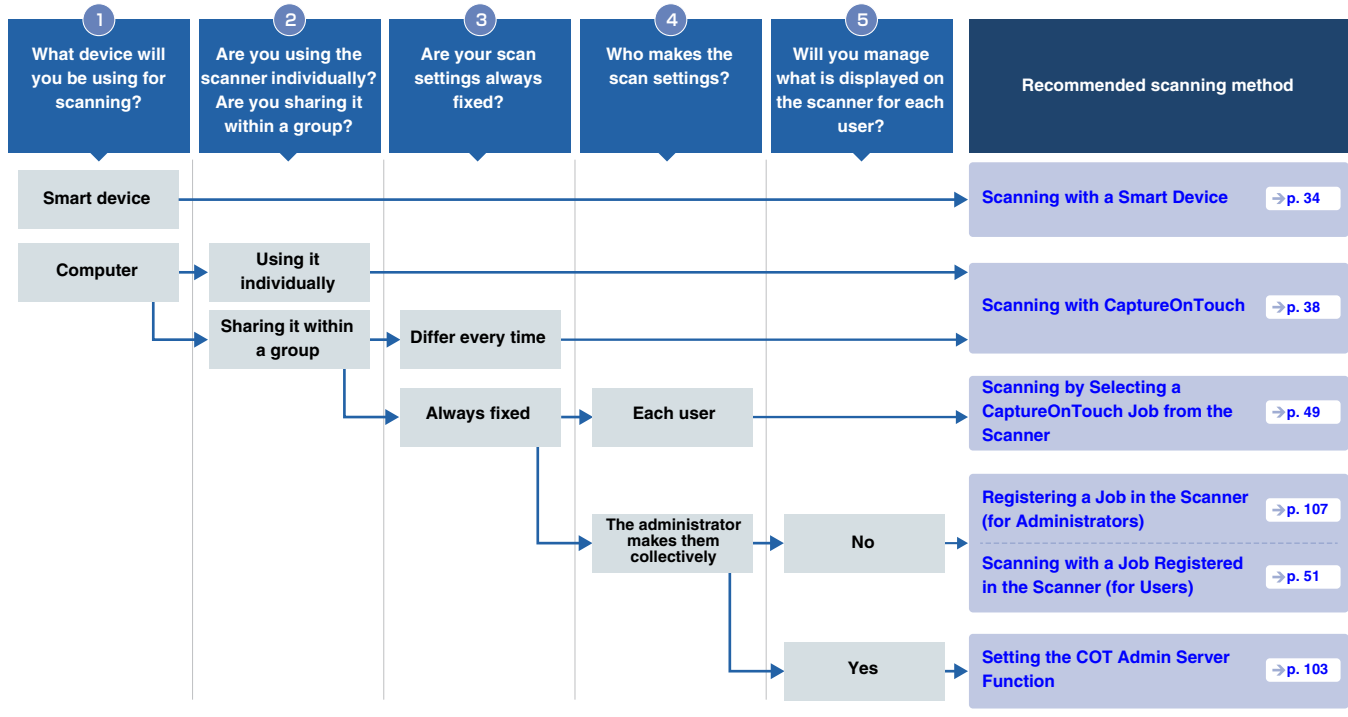

Scanning with a Smart Device

When scanning from a smart device, scan with the CaptureOnTouch Lite Web function from the Web Menu.

You can start scanning immediately without installing scanner drivers or software.

IMPORTANT

The smart device and the scanner must be on the same network.

Displaying the Web Menu

The Web Menu is a tool that enables you to scan, make scanner settings, and display information, using a web browser.

Scanning from the Web Menu is achieved by the CaptureOnTouch Lite Web function.

For information about the scanner settings that can be made from the Web Menu, refer to “Making settings” (See p. 55).

Displaying the Web Menu from the QR code on the operation panel

1 Press the Menu key on the operation panel.

The [Settings Menu] appears.



2 Press the ▲ and ▼ keys to select [COT Lite Web] and press the OK key.

A QR code appears.

3 Scan the QR code with the smart device.

The Web Menu appears.

Displaying the Web Menu by entering the IP address of the scanner into the web browser

1 Start the web browser on the smart device.

2 Enter the IP address of the scanner into the address field of the web browser.

The Web Menu appears.

Hint

If you are using a computer, you can also display the Web Menu from the Canon imageFORMULA Driver Setting Tool. (See p. 120)

Scanning with CaptureOnTouch Lite Web

The following explains the procedure for scanning and saving a document with CaptureOnTouch Lite Web. Refer to the Help of the Web Menu for detailed settings.

1 Place the document in the scanner.

2 Display the Web Menu. (See p. 34)

3 Click [Scan].

If you are asked for a password, enter the password. Refer to “Setting CaptureOnTouch Lite Web (Web Menu Only)” (See p. 102) to see if you need to use a password.



4 Set the [Scan mode].

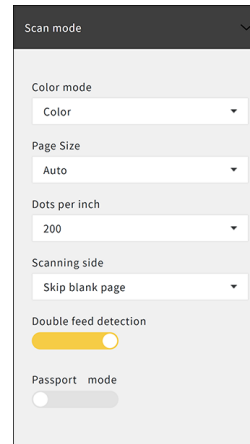

Color mode

Select the color mode for scanning the document from the following:

Color	Scan the document in color.
Grayscale	Scan the document in grayscale.
Black and White	Scan the document in black and white.

Page Size

Specify the paper size of the document to be scanned. If you select [Auto], the scanner will detect the size of the document and scan it.

Dots per inch

Specify the resolution of the scan. The unit is dpi.

Scanning side

Skip blank page	If there are blank pages in the document, skip those pages when scanning.
Simplex	Scan only one side of the document.
Duplex	Scan both sides of the document.

Double feed detection

Turn ON/OFF the double feed detection function.

Passport mode

Scan the document with settings appropriate for a passport. When it is turned ON, [Double feed detection] is turned OFF.

5 Click [Output mode] and set the [Output mode].

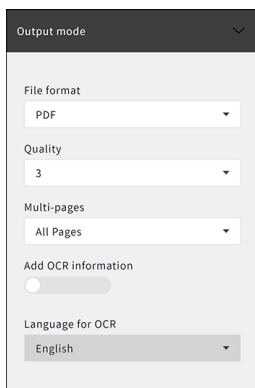

File format

Specify the file format for the scanned image to be saved.

Quality

You can set the image quality on a scale of 1 to 4.

Setting it to “1” results in the highest compression rate, reducing the file size of the scanned image, but degrading the image quality.

Setting it to “4” results in the lowest compression rate, reducing the degradation of the image quality.



Hint

This is effective when the [Color mode] in [Scan mode] is set to [Color] or [Grayscale].

Multi-pages

Specify the saving method when scanning a document with multiple pages.

All Pages	Save all pages of the document into one file.
Single Page	Save each specified number of pages into one file.



Hint

This is effective when [File format] is [PDF] or [TIFF].

Add OCR information

When you turn it ON, the text part of the scanned image is recognized and saved with the text data added.



Hint

This is effective when the [File format] is [PDF].

Language for OCR

Set the language to be recognized with [Add OCR information].



Hint

This is effective when the [File format] is [PDF] and [Add OCR information] is turned ON.

6 Click [Scan].

Scanning starts.

When the scan is finished, the [Check scanned images] screen opens.



Hint

If scanning continuously, set the next document, and click the [Continue Scanning] button. Document scanning starts.



7 Once you have confirmed the scanned image, click [Save].

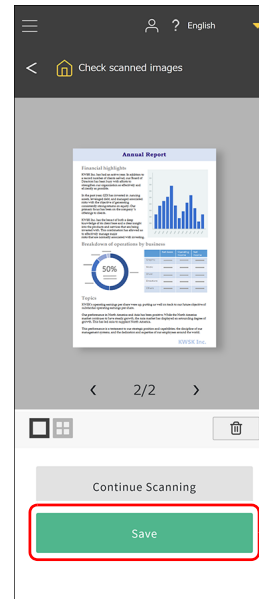

The scanned image file will be compressed into a ZIP file and saved within the smart device.

Scanned image

The image saved on the smart device can be moved to online storage or utilized in cloud services using the functions of the smart device and applications. For details, refer to the instruction manual of the smart device.

Scanning with CaptureOnTouch

CaptureOnTouch is a scanning application that enables you to scan a document with a simple operation merely by selecting the screen panel. Multiple scanning methods, which can be selected according to the purpose and application, are available.

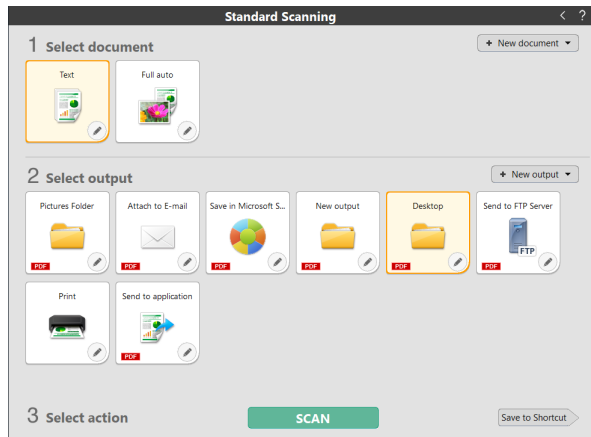

Standard Scanning

Select the document type and the output method according to the purpose of the scan from the panels, and scan the document.

Scanning Shortcut

If you save a combination of frequently used document type and output method as a shortcut, you can have the document scanned and outputted by clicking one panel. This is useful when you use the same setting repeatedly.

Starting and Exiting CaptureOnTouch

By default, CaptureOnTouch becomes resident in the system when you start your computer.

Windows





Click  in the taskbar and then click [Open CaptureOnTouch] from the menu which appears to start CaptureOnTouch and display the main window.

Hint

You can also start CaptureOnTouch from the Start menu. Click [Start] – [CaptureOnTouch] – [CaptureOnTouch V5 Pro] (for 32-bit Windows 10, [CaptureOnTouch V4 Pro]) in this order.

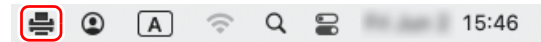
Mac



Click  (CaptureOnTouch icon) in the menu bar and then click [Launch CaptureOnTouch] from the menu which appears to start CaptureOnTouch and display the main window.

Exiting CaptureOnTouch

Windows

To close the CaptureOnTouch window, click at  the top of the window. This closes the window, but CaptureOnTouch will continue to reside in the system.

To quit the CaptureOnTouch application, click  in the taskbar, and select [Exit] from the menu.

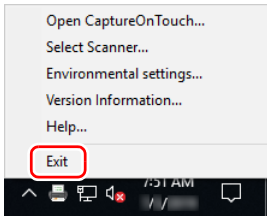

CaptureOnTouch becomes no longer resident in the system and the icon disappears from the taskbar.

Mac

To close the CaptureOnTouch window, click at ● the top of the window. This closes the window, but CaptureOnTouch will continue to reside in the system.

Click  (CaptureOnTouch icon) in the menu bar, and select [Exit] from the menu.

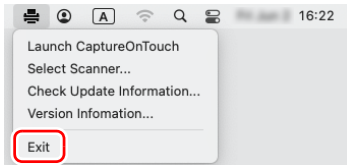

Restarting CaptureOnTouch

To use CaptureOnTouch after it has been made not resident in the system, use one of the following procedures to restart it. CaptureOnTouch will start and become resident in the system again.

Windows

Click [Start] – [CaptureOnTouch] – [CaptureOnTouch V5 Pro] (for 32-bit Windows 10, [CaptureOnTouch V4 Pro]) in this order.

Mac

Open [GO] – [Applications] folder from the Finder, and double-click [CaptureOnTouch].

Selecting a scanner

The following is an explanation of how to select a scanner using CaptureOnTouch.

→ Windows

→ Mac

Windows

1 Click the  (CaptureOnTouch icon) on the taskbar.



2 Click [Select Scanner] on the menu.

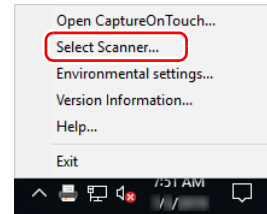

3 Select the scanner you are using and click [OK].

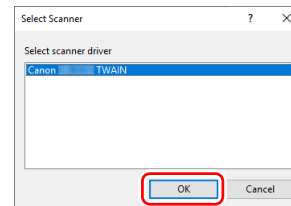

Hint

If the scanner you are using does not appear, reinstall the scanner driver.

Mac

- 1 Click  (CaptureOnTouch Icon) in the menu bar and then click [Select Scanner] from the menu which appears.

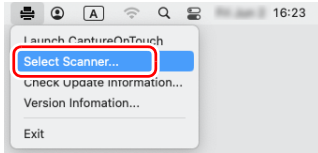

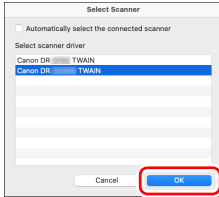

- 2 Select the scanner you are using and click [OK].



Screen Descriptions

There are two areas in the CaptureOnTouch main screen, [Scanning Shortcut] and [Standard Scanning].

Use the   at the top right of the main window to move between sections.

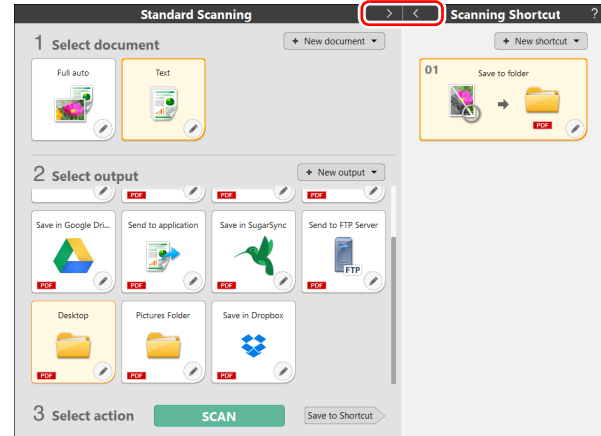

Various panels have been prepared according to the scan types and outputs in each section.

Click the [New document]/[New output]/[New shortcut] button, and a new panel will be added.

Hint

Click  to open the Help. [Windows](#)

Standard Scanning

Operations;

Selecting the Select document panel -> Selecting the Select output panel -> Start scanning

1 Place the document in the scanner.

2 Click the select document panel for the document to be scanned from [1 Select document].

The selected [Select document] panel will be displayed in orange.

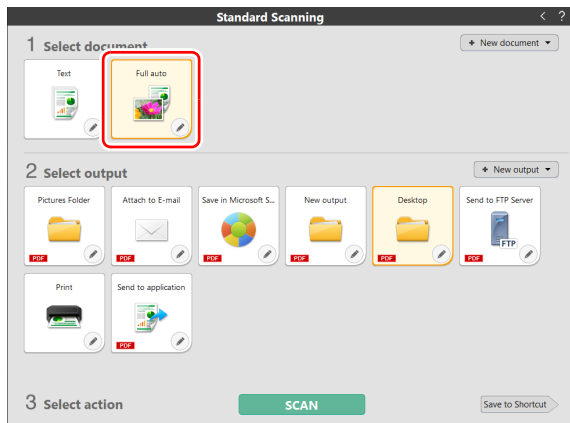

3 Click the output panel for the scan image application from [2 Select output].

The selected [Select output] panel will be displayed in orange.

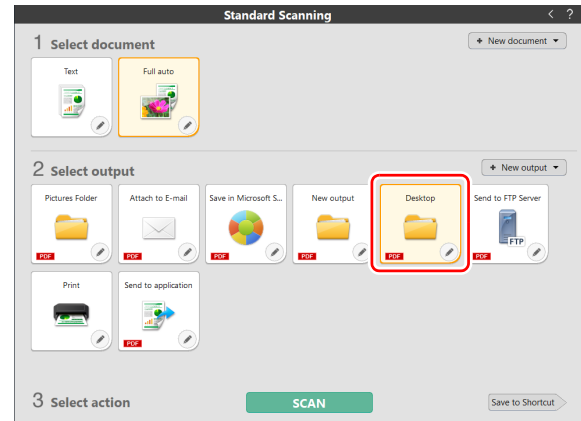

4 Click the [SCAN] button.

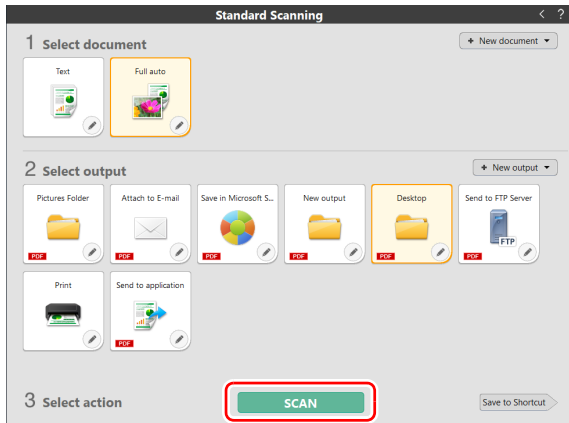

The document is scanned.

When the scan is finished, the preview screen opens.

Hint

If using the same document selection and output combination the next time, click the [Save to Shortcut] button.

The Select document and Select output that you selected are added to Scanning Shortcut. A new panel is added in the Scanning Shortcut panel view.

CAUTION

- If you configure scanning conditions that consume a large amount of the computer's memory, scanning may stop because of insufficient memory. If an error message appears due to insufficient memory while scanning is in progress, stop scanning, change the scanning conditions, and then try scanning again.
- A multiple-page scan cannot be saved when it reaches the file size of 2 GB. Change the save settings if an error message is displayed.

Hint

If scanning continuously, set the next document, and click the [Scan more pages] button. Document scanning starts.

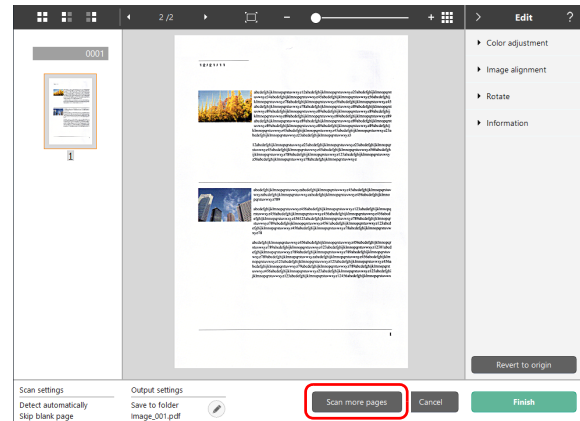

5 To check the scanned image, click the [Finish] button.

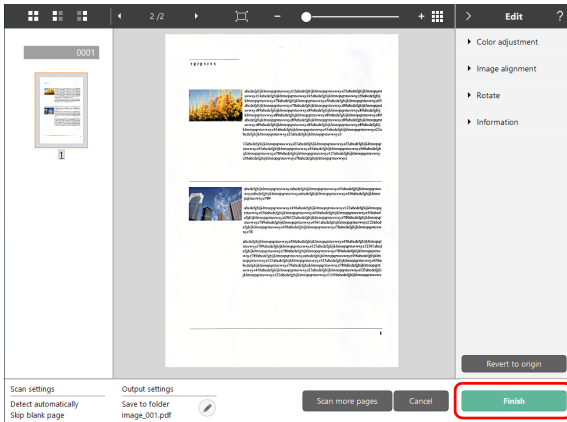

Click the  button to edit the output settings.

Click the [Cancel] button to discard the scanned image and return to the main window.

When the output has finished, a popup window will be displayed. If saving the scanned image, a link to open the save destination folder will be displayed.

This completes the Standard Scanning.

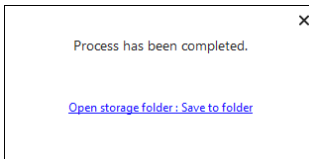

Hint

If you click [Open storage folder], the folder in which the saved scanned images were saved opens. Depending on the output settings, the [Open storage folder] link may not be displayed.

Scanning Shortcut

Operations;

Save [Scanning Shortcut] -> Scan the document -> Output the scanned images

By adding scanning shortcuts that combine frequently-used document selections and outputs, you can scan just by clicking the Scanning Shortcut panel.

Hint

If a registered scanning shortcut is assigned as a job, you can run shortcut scans using these settings from the operation panel of the scanner. (See p. 49)

Registering and editing scanning shortcuts

Multiple scanning shortcuts can be allocated to CaptureOnTouch.

1 Either click the [New shortcut] button in [Scanning Shortcut], or select the document panel and output panel in [Standard Scanning], and click the [Save to Shortcut] button.

A scanning shortcut panel will be created.

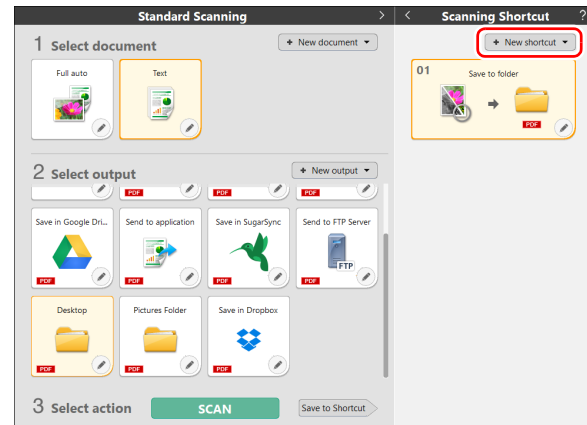



Hint

You can also create a new shortcut panel by clicking  on the [New shortcut] button, and in the menu that appears, selecting the type of Scanning Shortcut.

2 The Edit Scanning Shortcut Panel dialog box appears when you click the Edit button.

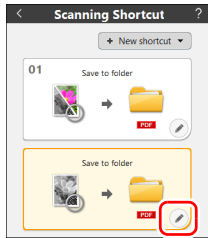

3 Click the [Document] tab to set the Select document settings.

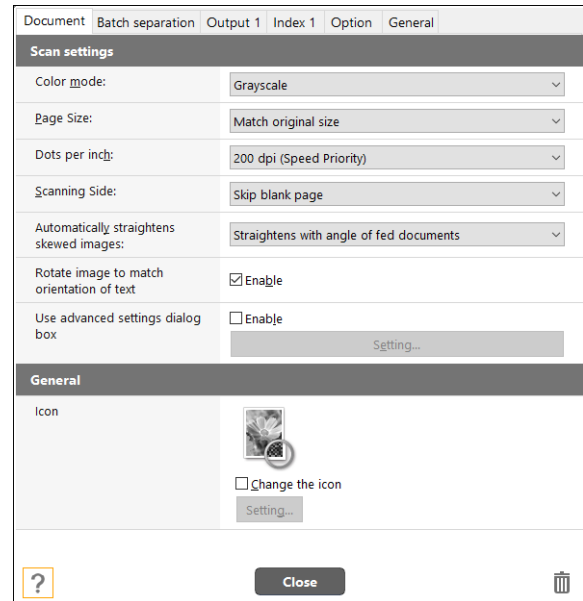

4 Click the [Batch separation] tab to set the batch separation. **Windows**

Document Batch separation Output 1 Index 1 Option General

Batch separation setting

Separation method: No Separation
Detail Settings...

Separation paper: Discard page

Head separation: Inert

Close

5 Click the [Output] tab to set the outputs.

Document Batch separation Output 1 Index 1 Option General

Output settings

Output method selection: Save to folder
Detail Settings...

File name / folder name: Image_
Detail Settings...

File type: PDF (*.pdf)
Detail Settings...

Save in folder: Pictures
Detail Settings...

General

Icon: Change the icon
Setting...

Close

6 Click the [Index] tab to set the index file. **Windows**

Document Batch separation Output 1 Index 1 Option General

Index settings

Page index: Output
Output settings...

Document index: @Output
Output settings...

Barcode / OCR settings: Area setting...

? Close

7 Click the [Option] tab to set the options.

Document Batch separation Output 1 Index 1 Option General

Option

Edit after scanning Enable

Enable additional scan Enable

Output a file when scanning Enable

Job assignment: No. 2

Order of output
+ X ↑ ↓
Save to folder

? Close

[Edit after scanning]

Check it on to enable modifying the scanned images in Scan Editing screen. When unchecked, the Edit window is not displayed in Scan Editing screen.

[Enable additional scan]

Check it on to display [Scan more pages] button in the Scan Editing screen to enable continuing scanning.

[Job assignment]

You can assign a scanning shortcut as a job.

When a scanning shortcut is assigned as a job, an icon for the assigned job No. will be displayed in the scanning shortcuts panel.

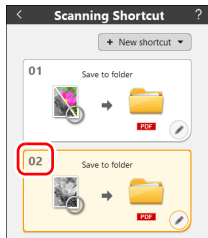

[Order of output]

You can add or delete the output, and also change the order of output.

8 Click the [General] tab to make other settings.



[Name]

Enter the Scanning shortcut panel name.

Selecting and scanning shortcuts

- 1 Place the document in the scanner.
- 2 Click the scanning shortcut panel.



The document is scanned.

When the scan is finished, the preview screen opens.

⚠ CAUTION

- If you configure scanning conditions that consume a large amount of the computer's memory, scanning may stop because of insufficient memory. If an error message appears due to insufficient memory while scanning is in progress, stop scanning, change the scanning conditions, and then try scanning again.
- A multiple-page scan cannot be saved when it reaches the file size of 2 GB. Change the save settings if an error message is displayed.

💡 Hint

If scanning continuously, set the next document, and click the [Scan more pages] button. Document scanning starts. If [Enable additional scan] is disabled in the scanning shortcut settings, the [Scan more pages] button will not be displayed.

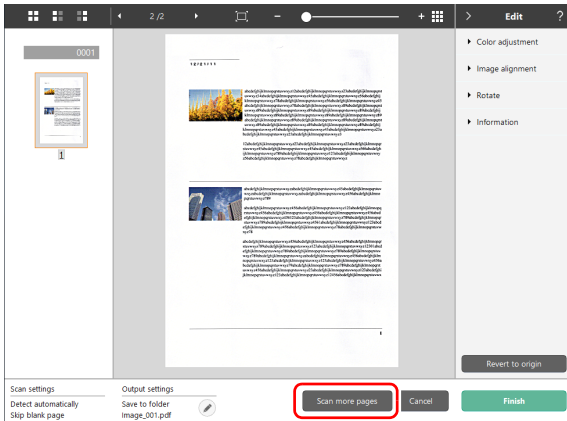

3 To check the scanned image, click the [Finish] button.

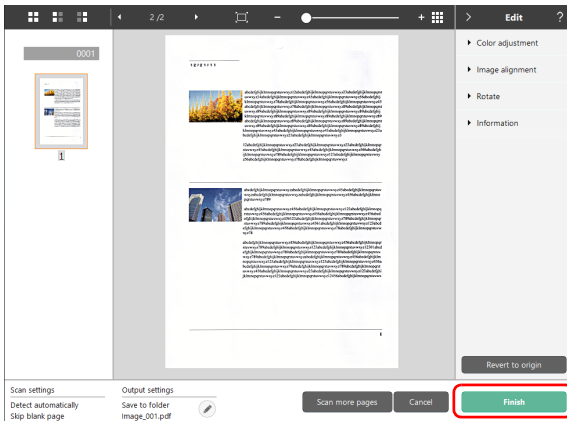

Hint

If [Edit after scanning] is disabled in the scanning shortcut settings or if [Output a file when scanning] is enabled, the edit window will not be displayed.

Click the  button to edit the output settings.

Click the [Cancel] button to discard the scanned image and return to the main window.

When the output has finished, a popup window will be displayed. If saving the scanned image, a link to open the save destination folder will be displayed.

This completes the shortcut scans.

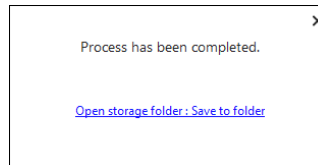

Hint

If you click [Open storage folder], the folder in which the saved scanned images were saved opens. Depending on the output settings, the [Open storage folder] link may not be displayed.

Scanning by Selecting a CaptureOnTouch Job from the Scanner

By registering a frequently-used scanning method as a scanning shortcut in CaptureOnTouch and assign a job number, you can scan by selecting the job number from the operation panel of the scanner.

Hint

If [Do not display the main screen when the scan is started with the scanner button] is checked in the CaptureOnTouch Environmental settings, the CaptureOnTouch main screen will not be displayed when a scan is started from the operation panel. Only dialog boxes and error messages during scanning, and completion popup windows are displayed. In addition, [Edit after scanning] and [Enable additional scan] in the Edit Scanning Shortcut Panel dialog box are disabled.

Creating a Job with CaptureOnTouch

- 1 Refer to “[Registering and editing scanning shortcuts](#)” (See p. 43) to create a scanning shortcut panel.
- 2 Set a job number for [Job assignment] on the [Option] tab.

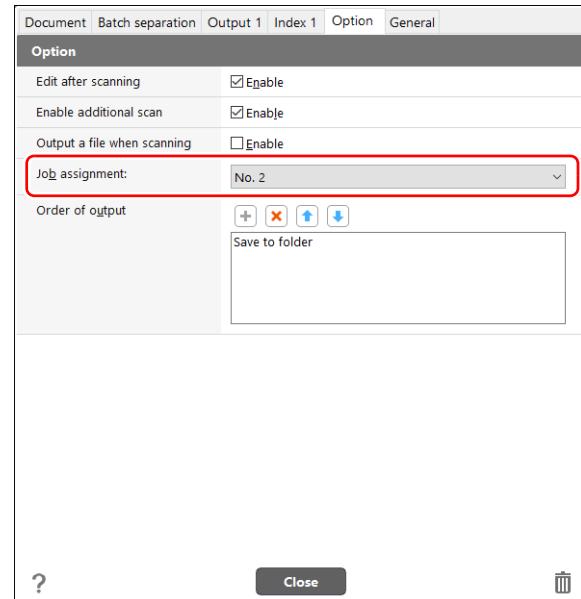

The screenshot shows the 'Option' tab of the 'Edit Scanning Shortcut Panel' dialog box. The 'Job assignment' dropdown menu is highlighted with a red box and set to 'No. 2'. Other options include 'Edit after scanning' (checked), 'Enable additional scan' (checked), and 'Output a file when scanning' (unchecked). The 'Order of output' section has four buttons: '+', 'X', '↑', and '↓'. Below these is a 'Save to folder' text box. At the bottom, there is a 'Close' button and a trash icon.

Document	Batch separation	Output 1	Index 1	Option	General
Option					
Edit after scanning		<input checked="" type="checkbox"/>	Enable		
Enable additional scan		<input checked="" type="checkbox"/>	Enable		
Output a file when scanning		<input type="checkbox"/>	Enable		
Job assignment:		No. 2			
Order of output		<input type="button" value="+"/>	<input type="button" value="X"/>	<input type="button" value="↑"/>	<input type="button" value="↓"/>
Save to folder					
?					
Close					
					

Selecting a Job from the Scanner

- 1 On the [Select Job] screen on the operation panel of the scanner, press the ▲ and ▼ keys to select the computer in which jobs are registered, and press the OK key.



Jobs that are registered in CaptureOnTouch on the computer are displayed.

Jobs on USB	Select this to use a job registered in CaptureOnTouch on the computer connected to the scanner via USB.
Jobs on Scanner	Select this to use a job registered in the scanner. Refer to “ Scanning with a Job Registered in the Scanner (for Users) ” (See p. 51).
Jobs on <Computer Name>	Select this to use a job registered in CaptureOnTouch on the computer connected to the scanner via wired LAN.

- 2 Press the ▲ and ▼ key to select the job you want to execute.

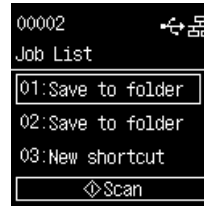

- 3 Press the Start key.

Scanning starts.

While scanning is in progress, the number of pages scanned is indicated on the display, in addition to the scanner settings.

Scanning with a Job Registered in the Scanner (for Users)

You can scan by calling a job pre-registered in the scanner from the operation panel. For details of how to register jobs in the scanner, refer to “[Registering a Job in the Scanner \(for Administrators\)](#)” (See p. 107).

- 1 On the [Select Job] screen on the operation panel of the scanner, select [Jobs on Scanner], and press the OK key.**



- 2 Select the job you want to execute from the [Job List] screen.**

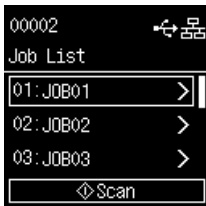

- 3 Press the Start key.**

Scanning starts.

While scanning is in progress, the number of pages scanned is indicated on the display, in addition to the scanner settings.

Hint

When you press the OK key while a job is selected, the [Job Settings] screen will open.

You can temporarily change the job settings, [Color Mode], [Dots per inch], [Page Size], and [Scanning Side].

This is convenient when you need to scan a document that differs from the usual ones.

Use the ▲ and ▼ keys to select the item you want to set, and press the OK key.

Once you scan something or return to the [Job List] screen with the Back key, the settings on the [Job Settings] screen will reset back to their original state.

Scanning with a Mopria-Compatible Device

You can scan with a standard application of a Mopria-compatible device. For details, refer to the instruction manual of the device used.

 **IMPORTANT**

Depending on the application, the functions may be restricted.

Scanning with More Detailed Settings

If you want to scan with the advanced settings dialog box of CaptureOnTouch or with software other than the bundled software, refer to the Help of the scanner driver.

Setting the Long Document Mode

The length of documents that can be scanned with the scanner is normally 356 mm (14"), but you can scan documents up to 5,588 mm (220") long by setting the scanner to the Long Document mode.

! IMPORTANT

By selecting the Long Document mode and setting the [Page Size] on the scanner driver settings screen to Auto-detection, documents of up to 5,588 mm (220") in length can be scanned. Note the following when using the Long Document mode:

- When scanning in the Long Document mode, if the document is placed on the scanner in a skewed position, it may hit the edges of the feeding area and be damaged. Be careful to place the document so that it is not skewed.
- When scanning with the Long Document mode, paper jam detection may react slowly, resulting in damage to the document. Be careful to avoid paper jams.
- When scanning long documents, make sure to set the feed selection lever to Bypass mode, and scan the documents one at a time.
- When scanning large-sized documents with the Long Document mode, scanning may be slower. Errors also occur due to memory shortage, and scanning may be disabled.
- When scanning documents with [Long Document Mode (3000 mm)] or [Long Document Mode (5588 mm)] selected on the [Long Document Mode] tab, the image may not be scanned completely if 400 dpi or 600 dpi is selected, or if [Color] is selected for [Color mode] and [Duplex] is selected for [Scanning Side]. If this happens, select a lower dpi, or select [Monochrome] for [Color mode] or [Simplex] for [Scanning Side] and scan the document.

Detecting a document double feed

This scanner includes a function to detect document double feeds. By using this function, the scanner will automatically stop when it detects that multiple documents have been fed at the same time.

You can also specify whether to save the scanned image after scanning has finished and continue scanning the document (Rapid recovery system).

For details, refer to the Help of the scanner driver.

What to do when a double feed is detected

When not using the rapid recovery system

If a document double feed is detected during scanning, document feeding stops when the double fed documents are ejected. When this happens, the following error appears on the display.

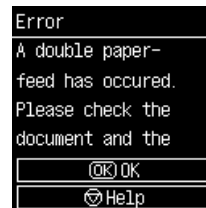

Also, a message screen is displayed to notify you that a double feed has been detected.

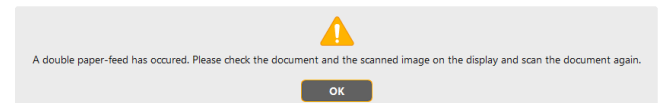

When this happens, stop the scanning in the application and then scan the documents again.

When using the rapid recovery system

If a document double feed is detected during scanning, document feeding stops when the double fed documents are ejected. The following message appears on the display, and you can specify whether to continue scanning.

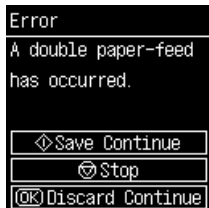

Also, the [Rapid Recovery System] screen appears to enable you to specify whether to continue scanning.

Windows

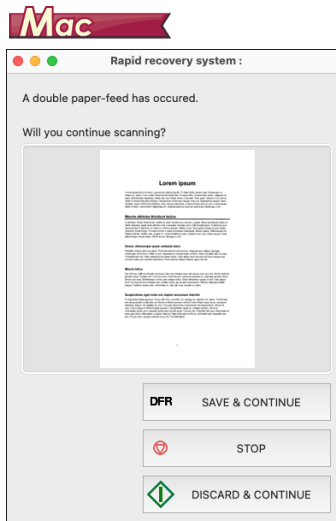
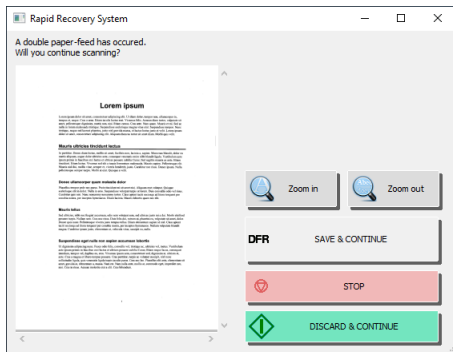

Buttons of [Rapid recovery system] Screen	Description
[SAVE & CONTINUE]	Saves the preview image as a scanned image and scans the rest of the document.
[STOP]	Discards the preview image and stops scanning.
[DISCARD & CONTINUE]	Discards the preview image and continues scanning. Place the double fed document again before clicking this button.

Making settings

You can make the detailed settings for the scanner from the Web Menu displayed by the web browser and the Settings Menu on the operation panel.

If you want to do a search from menu items, see [“Web Menu List” \(p. 60\)](#)/[“Settings Menu List” \(p. 61\)](#)

If you want to do a search from purposes, see [“List of Purpose-by-Purpose Settings” \(p. 62\)](#)

Web Menu

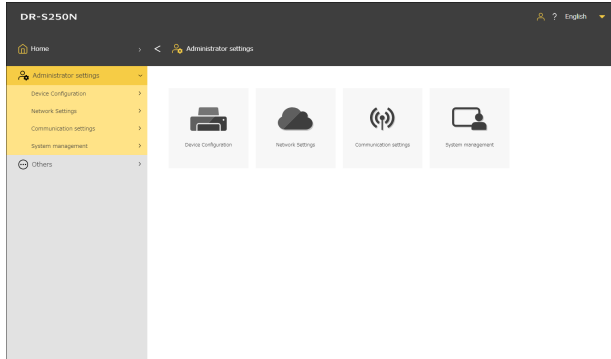

Settings Menu

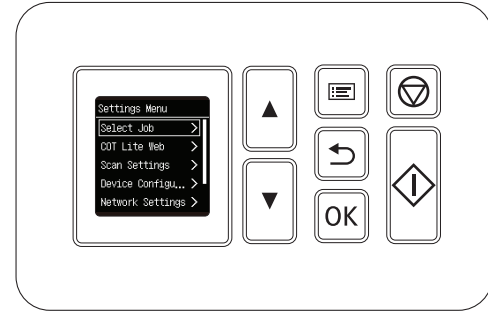

! IMPORTANT

We recommend the following web browsers:

Windows	Microsoft Edge latest version
	Firefox latest version
	Chrome latest version
macOS	Safari latest version
Android	Chrome latest version
iOS	Safari latest version



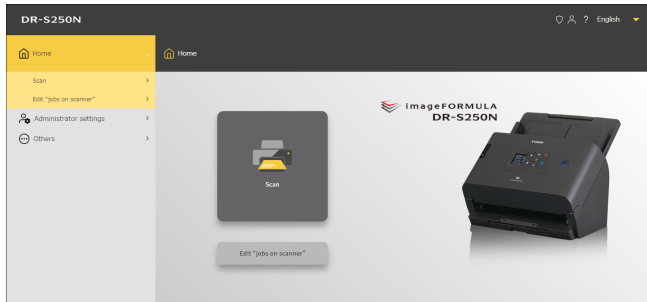

Web Menu Operating Procedure

For information about displaying the Web Menu, refer to “[Displaying the Web Menu](#)” (See p. 34).

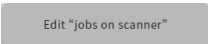
Screen Descriptions

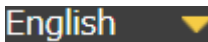

	Performs a scan. (See p. 35)
	Displays the screen for editing jobs to register in the scanner. (See p. 107)

	(When connected via https)	Displays the communication method with the Web Menu. Clicking this when connected via http changes the connection to https. If you want more secure communications, change to the https connection.
	(When connected via http)	Depending on the environment, a warning may appear on the web browser when you change to https. Refer to “ Installing an SSL Server Certificate (Web Menu Only) ” (See p. 99).
	(When logged in as an administrator)	Displays the login status. To log in as an administrator, you need the administrator password.
	(When logged in as a general user)	
		Displays the Help.
		Set the display language of the screen. It supports the following 15 languages. English/German/French/Italian/Spanish/Japanese/Dutch/Simplified Chinese/Traditional Chinese/Russian/Korean/Turkish/Portuguese/Thai/Vietnamese

Displaying Administrator Settings

1 Click [Administrator settings].

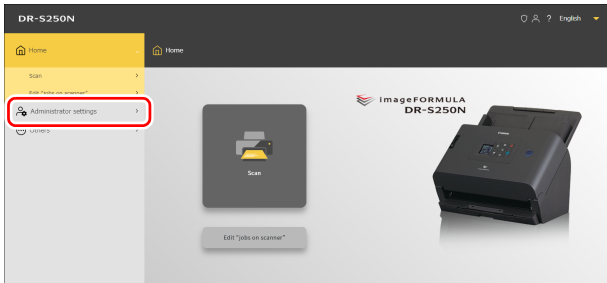

2 Enter the administrator password.

The administrator password at the time of factory shipment is written on the label affixed to the scanner.

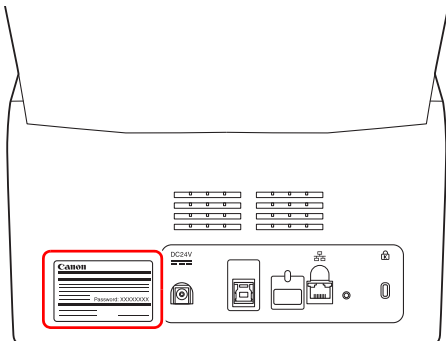

! IMPORTANT

To ensure security, we recommend changing the administrator password without leaving it as shipped from the factory. Refer to [“Setting an Administrator Password”](#) (See p. 100).

3 Click [OK]. The [Administrator settings] screen appears.

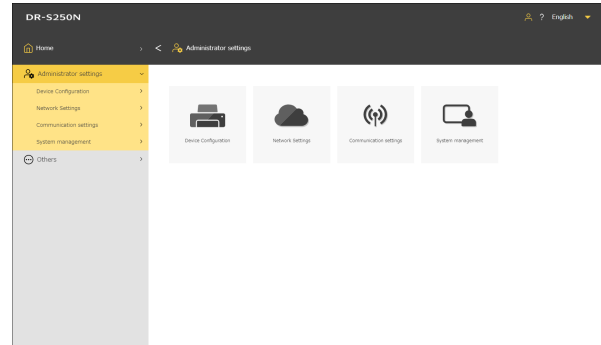

Settings Menu Operating Procedure

- 1 Press the Menu key on the operation panel.
The Settings Menu appears.

! IMPORTANT

Depending on the settings made by the administrator, you may need the administrator password to change settings.

Example of Operating Each Screen



Key to operate	Description
▲▼ Keys	Used to change the selected item.
OK Key	Used to make a confirmation.
Back Key	Returns you to the previous screen.

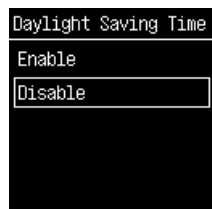

Key to operate	Description
▲▼ Keys	Used to change the selected item.
OK Key	Used to make a confirmation.
Back Key	Returns you to the previous screen without making a confirmation.

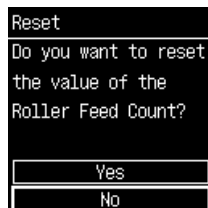

Key to operate	Description
▲▼ Keys	Used to change the selected item.
OK Key	Used to make a confirmation.
Back Key	Returns you to the previous screen without making a confirmation.



Key to operate	Description
▲▼ Keys	Used to change the value at the cursor position.
OK Key	Used to confirm the value at the cursor position. Used to move the cursor to the right. If the cursor is at the right end position, sets the data in the scanner.
Back Key	Used to move the cursor to the left. If the cursor is at the left end position, returns you to the previous screen without saving the value.
Start Key	Used to set the entered data in the scanner.



Key to operate	Description
▲▼ Keys	Used to change the value at the cursor position.
OK Key	Used to confirm the value at the cursor position. Used to move the cursor to the right.
Back Key	Used to move the cursor to the left. If a value has already been entered, it will be deleted. If the field is blank, the scanner returns to the previous screen without saving a value.
Menu Key	Used to switch upper-case characters, lower-case characters, numeric values, and symbols. The types that can be switched vary depending on the screen.
Start Key	Used to set the entered data in the scanner.

Web Menu List

Administrator settings

Device Configuration

Language/Timezone	p. 63 p. 64 p. 65
Roller Feed Count	p. 66 p. 67
Current Scan Count	p. 68
Date/Time	p. 69
Power management	p. 72
SNMP	p. 87
mDNS	p. 86
PIN	p. 96
Server Certificate	p. 99
Scanner Name	p. 73
Buzzer	p. 74

Network Settings

IPv4	p. 84
------	-----------------------

Communication settings

COT Admin Server	p. 103
Mail server	p. 92
SFTP server	p. 92

System management

Save settings	p. 77
Restore settings	p. 77
Functional restriction	p. 78
Manage icons	p. 78
Log output setting	p. 80
Version up	p. 79
Administrator Password	p. 100
Root Certificate	p. 93
Access Level	p. 80
Initialize	p. 75
SDK for UI customization	p. 101
CaptureOnTouch Lite Web Settings	p. 102

Others

Device information	p. 82
Network Information	p. 95
Version Information	p. 83

Settings Menu List

Scan Settings

Detect Double Feed	p. 81
Passport	p. 81

Device Configuration

Device Information	p. 82
Language	p. 63
Date & Time	—
Date & Time	p. 69
Date Display Format	p. 70
NTP Settings	p. 71
Timezone	p. 64
Daylight Saving Time Settings	p. 65
Power Management	p. 72
Maintenance	—
Roller Count	p. 66 p. 68
Roller Replacement	p. 67
Security	—
PIN Setting	p. 96
Admin Password Setting	p. 100
Scanner Name Setting	p. 73
Buzzer	p. 74
mDNS	p. 86
Initialize	p. 75

Network Settings

Network Information	p. 95
IP Address Settings	—
IPv4	p. 84
COTAdmin Settings	—
Server Settings	p. 103 p. 105 p. 106
Connection Test	p. 103

COT Lite Web

Displays a QR code on the display. By scanning it, you can use the CaptureOnTouch Lite Web function.

Version Information

Displays the version of the firmware of the scanner, etc.

Help

Displays the Help of scanning methods, error handling methods, and maintenance methods.

List of Purpose-by-Purpose Settings

Scanner Settings

To set the language for display	p. 63
To set an area	p. 64
To check/reset the roller count	p. 66
To set the time to replace the roller	p. 67
To check/reset the scan count	p. 68
To set the date and time	p. 69
To make the setting for automatically turning off the power	p. 72
To set the name for the scanner	p. 73
To set the buzzer	p. 74
To initialize all settings	p. 75
To reset the settings to the factory default state	p. 76
To back up settings	p. 77
To load backed up settings	p. 77
To restrict functions	p. 78
To change icons	p. 78
To upgrade the scanner	p. 79
To restrict the data that can be changed by general users	p. 80
To acquire scanner logs	p. 80
To temporarily disable double feed detection	p. 81
To temporarily set passport mode	p. 81
To display information about the scanner	p. 82

Network Settings

To set an IP address	p. 84
To search for the scanner via the network (enable mDNS)	p. 86
To perform management using SNMP	p. 87
To enable sending images by email (set a mail server)	p. 92
To increase the security of an SFTP connection (set a secret key)	p. 92
To manage root certificates	p. 93
To display network information	p. 95

Security Settings

To use a PIN when logging in	p. 96
To install an SSL server certificate	p. 99
To set an administrator password	p. 100

Web Menu Settings

To change the data to be displayed on the display of the scanner	p. 101
To set CaptureOnTouch Lite Web	p. 102

COT Admin Server Function Settings See [p. 103](#)

Registering a Job in the Scanner See [p. 107](#)

Scanner Settings

Make the settings for the scanner.



Hint

- Web Menu operating procedure: “Web Menu Operating Procedure” (See p. 56)
- Settings Menu operating procedure: “Settings Menu Operating Procedure” (See p. 58)

Setting the Language for Display

Set the language for displaying data on the operation panel of the scanner.

Setting value

English (English) / Japanese (日本語) / German (Deutsch) / French (Français) / Italian (Italiano) / Spanish (Español) / Dutch (Nederlands) / Simplified Chinese (简体中文) / Traditional Chinese (繁體中文) / Russian (Русский) / Korean (한국어) / Turkish (Türkçe) / Portuguese (Português)

Administrator settings > Device Configuration > Language/Timezone

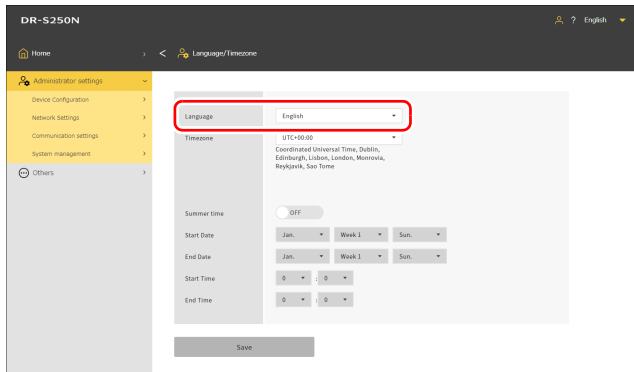

Click [Save] to save the settings.

Settings Menu > Device Configuration > Language



Setting an Area

Set an area according to the area where you are using the scanner.

Setting a time zone

Set a time zone according to the area where you are using the scanner.

Setting value

UTC -12:00 to UTC +14:00

00 min / 15 min / 30 min / 45 min

Administrator settings > Device Configuration > Language/Timezone

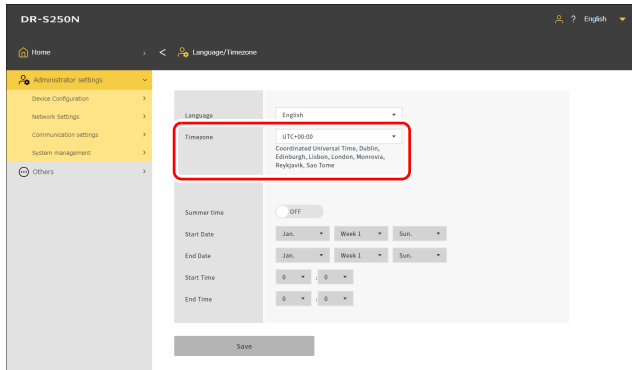

Click [Save] to save the settings.

Settings Menu > Device Configuration > Date & Time > Timezone



Setting summer time

Set summer time according to the area where you are using the scanner.

Administrator settings > Device Configuration > Language/Timezone

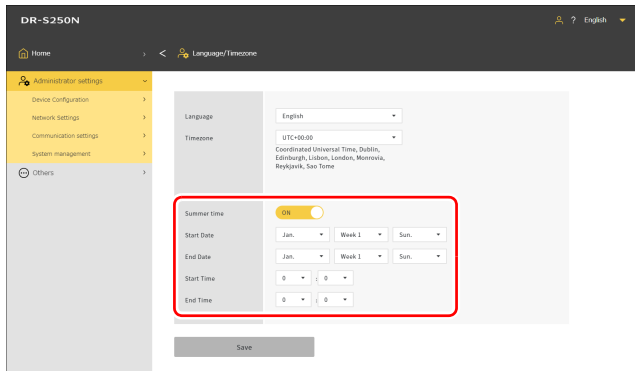

Click [Save] to save the settings.

Settings Menu > Device Configuration > Date & Time > Daylight Saving Time Settings > Daylight Saving Time

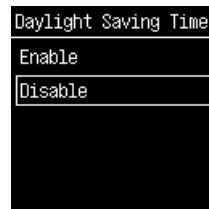

Settings Menu > Device Configuration > Date & Time > Daylight Saving Time Settings > Period Settings

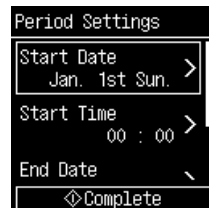

Checking/Resetting the Roller Feed Count

Check the total number of pages fed by the scanner (total number of pages of the document fed by the scanner). When replacing the roller with a new one, reset the counter.

Administrator settings > Device Configuration > Roller Feed Count

Click [Reset] to reset the count.

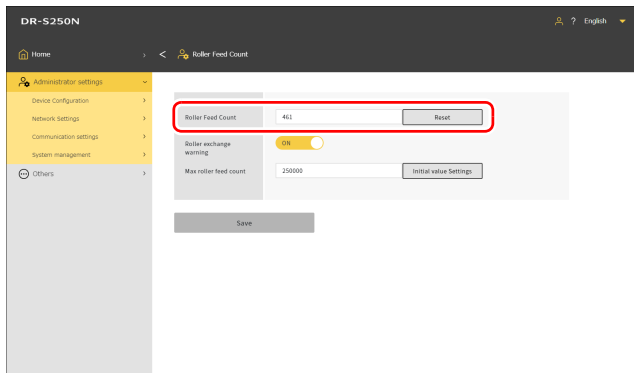

Click [Save] to save the settings.

Settings Menu > Device Configuration > Maintenance > Roller Count > Roller Feed Count



Setting the Time to Replace the Roller

Set whether to display a warning when it is time to replace the roller, as well as the approximate scan count that serves as a guideline for when to replace it.

Administrator settings > Device Configuration > Roller Feed Count

Click [Initial value Settings] to reset Max roller feed count (recommended number of pages for roller replacement) to the factory default value.

Hint

You can also change Max roller feed count, using the Canon imageFORMULA Driver Setting Tool. (See p. 120)

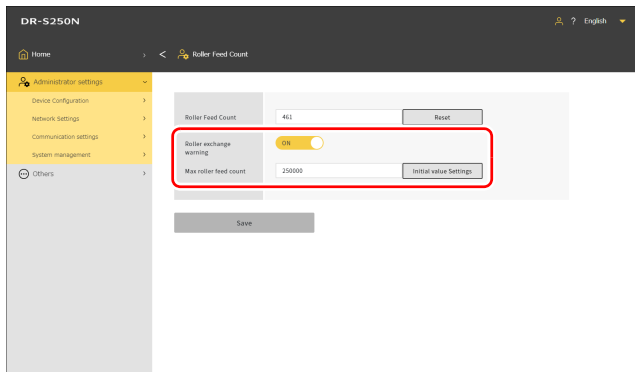

Click [Save] to save the settings.

Settings Menu > Device Configuration > Maintenance > Roller Replacement > Enable Notification

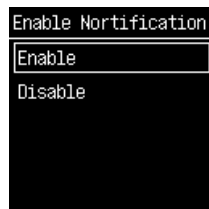

Settings Menu > Device Configuration > Maintenance > Roller Replacement > Max Count Setting

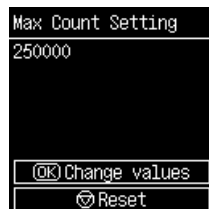

Checking/Resetting the Scan Count

Check/reset the scan count.

Administrator settings > Device Configuration > Current Scan Count
Click [Reset] to reset the count.

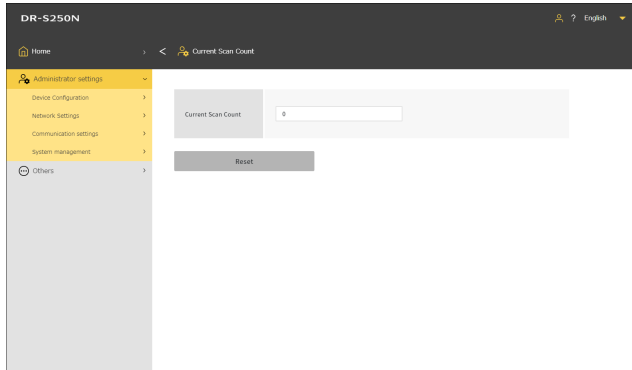

Settings Menu > Device Configuration > Maintenance > Roller Count > Current Scan Count

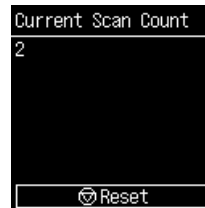

Setting the Date and Time

Set the date/time for the scanner.

Setting the date/time

Administrator settings > Device Configuration > Date/Time

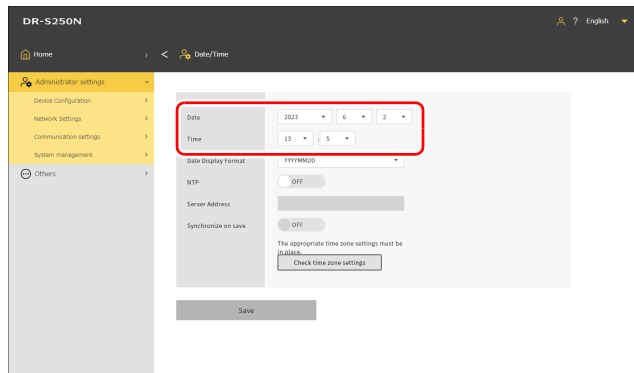

Click [Save] to save the settings.

Settings Menu > Device Configuration > Date & Time > Date & Time > Date



Settings Menu > Device Configuration > Date & Time > Date & Time > Time



Setting the date/time display format

Setting value

YYYYMMDD / MMDDYYYY / DDMMYYYY

Administrator settings > Device Configuration > Date/Time

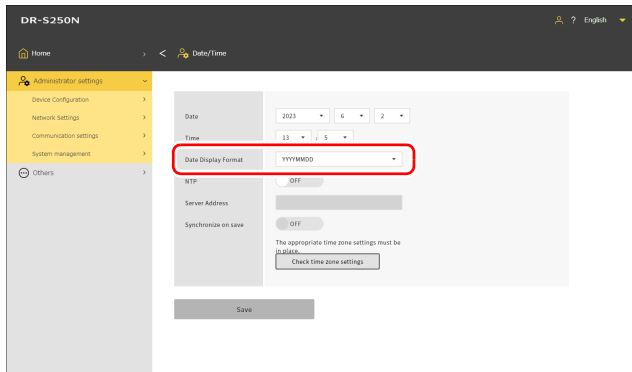

Click [Save] to save the settings.

Settings Menu > Device Configuration > Date & Time > Date Display Format

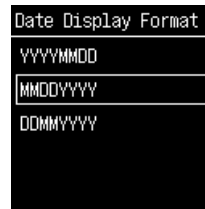

Setting an NTP server

If the scanner is connected to the Internet, you can set it to synchronize with an NTP server.

Administrator settings > Device Configuration > Date/Time

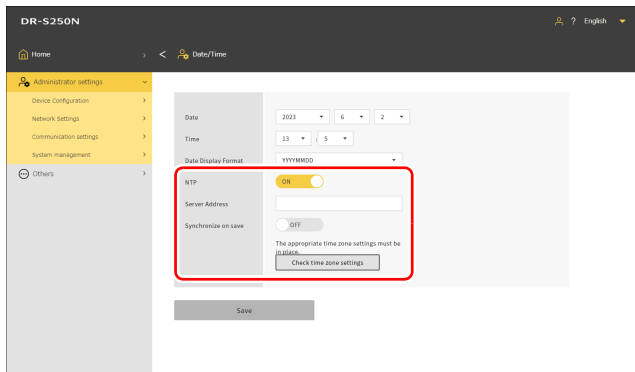

NTP

Sets the NTP function to enabled/disabled.

Server Address

Enter the host name or IP address of the NTP server.

Synchronize on save

When it is turned ON, synchronization begins at the same time as saving.

Check time zone settings

Click it to move to the [Language/Timezone] screen ([See p. 64](#)).

Click [Save] to save the settings.

Settings Menu > Device Configuration > Date & Time > NTP Settings > NTP Enable

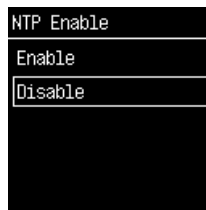

Settings Menu > Device Configuration > Date & Time > NTP Settings > NTP Server

Enter the host name or IP address of the NTP server.

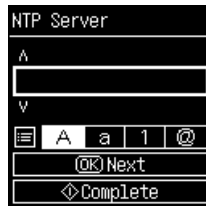

Making the Setting for Automatically Turning Off the Power

Sets the Auto Power Off Function.

When enabled, it will automatically turn off the power to the scanner if the scanner is left unoperated for four hours.

Administrator settings > Device Configuration > Power management

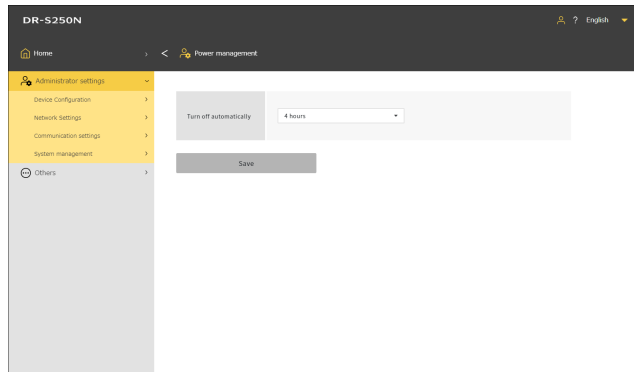

Click [Save] to save the settings.

Settings Menu > Device Configuration > Power Management > Auto Power Off

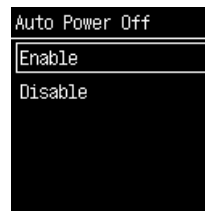

Setting the Name for the Scanner

Set it with up to 15 single-byte characters. You can use uppercase and lowercase English letters, numbers, and hyphens (-).

Administrator settings > Device Configuration > Scanner Name

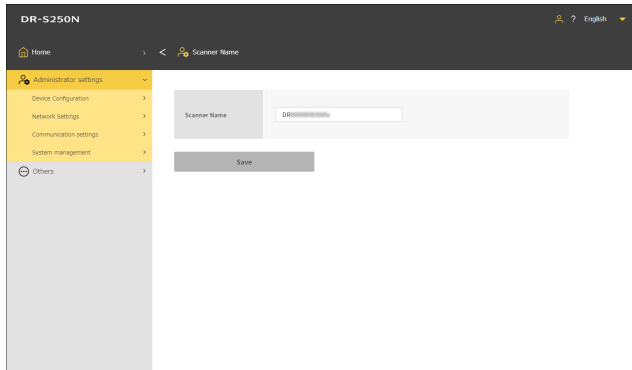

Click [Save] to save the settings.

Settings Menu > Device Configuration > Security > Scanner Name Setting

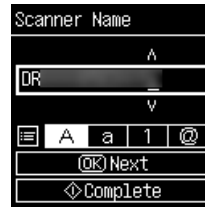

Setting the Buzzer

Set the timing of when the buzzer sound of the scanner is activated.

Setting value

Error	The buzzer sound is activated only when an error occurs.
Operation sound + error	The buzzer sound is activated when an error occurs and when a key on the operation panel is pressed.



Hint

The volume of the buzzer cannot be changed.

Administrator settings > Device Configuration > Buzzer

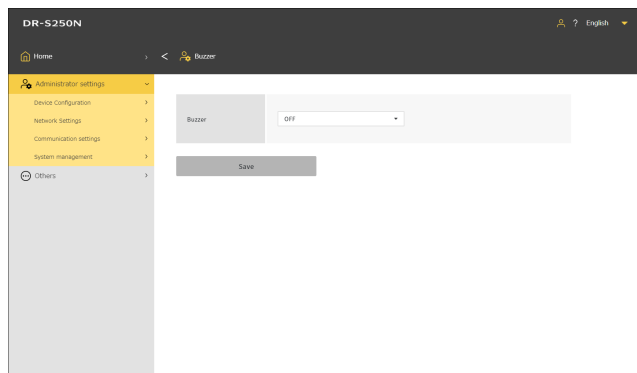

Click [Save] to save the settings.

Settings Menu > Device Configuration > Buzzer

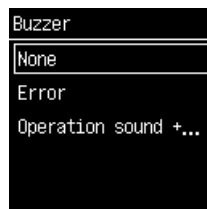

Initializing All Settings

Initialize all settings for the scanner.

Administrator settings > System management

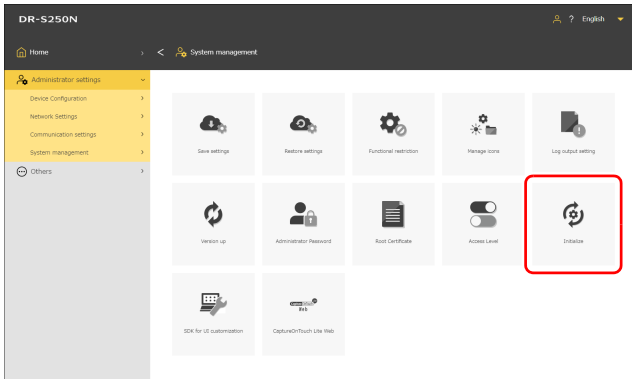

Settings Menu > Device Configuration > Initialize



- 1 Click [Initialize].**
- 2 Confirm the confirmation message and click [OK].**
All settings will be initialized.

Resetting Settings to the Factory Default State (Performing a Factory Reset)

Performing a factory reset not only initializes the scanner settings but also resets the firmware version to the factory default state.

- 1 Turn off the power to the scanner (See p. 21).**
- 2 While holding down the factory reset button (See p. 15), press the power button to turn on the power.**
- 3 When the power button starts to flash (quickly), release the factory reset button.**

The scanner is restarted several times and then the power button lights up to indicate that the factory reset is completed.

! IMPORTANT

Do not turn off the power to the scanner while a factory reset is in progress.

Backing Up Settings (Web Menu Only)

Back up settings for the scanner to the computer. You can re-load backed up settings. [“Loading Backed Up Settings \(Web Menu Only\)”](#) (See p. 77)

Administrator settings > System management

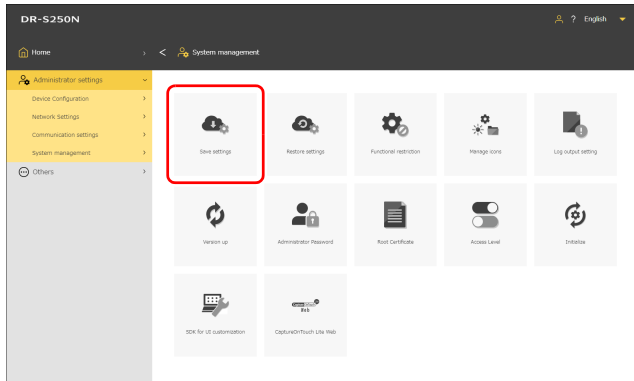

1 Click [Save settings].

The backup file will be saved to the computer.

Loading Backed Up Settings (Web Menu Only)

Load settings backed up to the computer. Settings will be overwritten by the backed up settings. [“Backing Up Settings \(Web Menu Only\)”](#) (See p. 77)

Administrator settings > System management > Restore settings

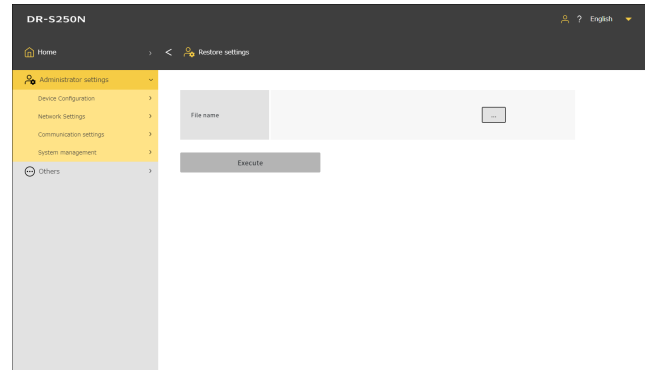

1 Click [...] and specify a backup file in the file selection dialog box.

Settings will be overwritten by the contents of the backup file. Upon completion of overwriting, the scanner will automatically restart.

Restricting Functions (Web Menu Only)

Make some of the functions of the scanner unusable. Turning it OFF causes the function to become unusable.

CaptureOnTouch Lite Web

Makes the CaptureOnTouch Lite Web function unusable. For details of the CaptureOnTouch Lite Web, refer to “Scanning with CaptureOnTouch Lite Web” (See p. 35).

Mopria Scan

Makes the Mopria Scan function unusable. For details of the Mopria Scan, refer to “Scanning with a Mopria-Compatible Device” (See p. 52).

CaptureOnTouch Mobile Scan

Makes the mobile app “CaptureOnTouch Mobile” unusable.

Change settings of “jobs on scanner”

When it is off, you can temporarily change job settings when scanning with a job registered in the scanner. (See p. 51) When you turn it on, you can no longer change the settings.

Administrator settings > System management > Functional restriction

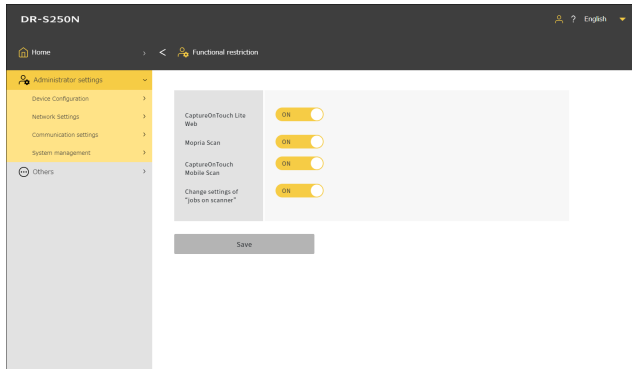

Click [Save] to save the settings.

Managing Icons (Web Menu Only)

Add and delete icons representing jobs to and from the Web Menu.

Administrator settings > System management > Manage icons

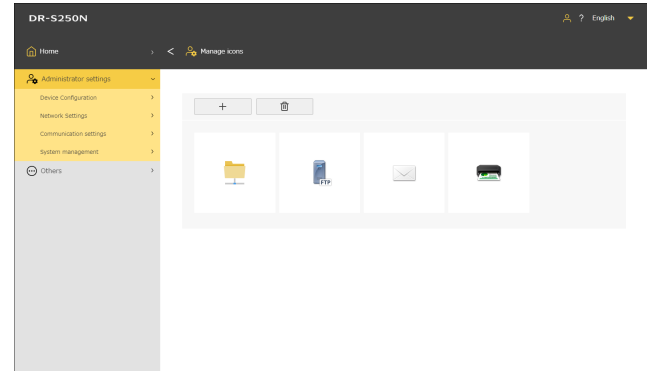

Adding an icon

- 1 Click .
The [Add icon] screen appears.
- 2 On the [Add icon] screen, click [...] and specify an icon file.
 **Hint**
 - The image file format that can be used is PNG format.
 - You can register up to 99 icons.
- 3 Click [Execute].
The icon is added.

Deleting an icon



Hint

You cannot delete the pre-registered shared folder icon, FTP server icon, mail icon, or printer icon.

- 1 Click .**
The [Delete icon] screen appears.
- 2 Click the icon you want to delete. To select all icons, [Select All].**
The selected icon is checked.
- 3 Click [OK].**
The selected icon is deleted.

Upgrading the Scanner (Web Menu Only)

Update the firmware for the scanner, using a firmware file.

Administrator settings > System management > Version up

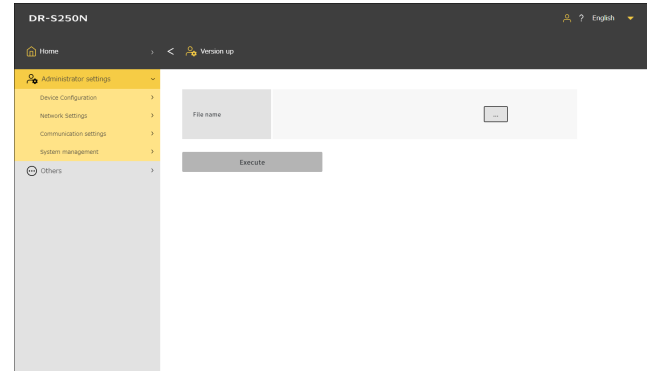

- 1 Click [...] and select a firmware file.**
- 2 Click [Execute].**
The scanner starts to upgrade. Progress is displayed during the upgrade.

IMPORTANT

- Do not turn off the scanner during the upgrade.
- Do not exit the web browser displaying the Web Menu or close the browser tab during the upgrade.

Restricting the Data That Can Be Changed by General Users (Web Menu Only)

You can specify whether an administrator password is required to change the settings for the items on the Settings Menu. By requiring the input of an administrator password, you can restrict the changes that general users can make.

Setting value

Read only	An administrator password must be entered to change the settings.
Read/Write	An administrator password need not be entered.

Administrator settings > System management > Access Level

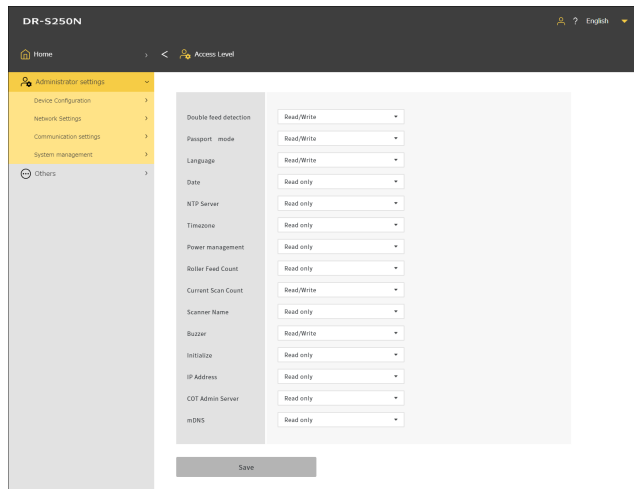

Click [Save] to save the settings.

Acquiring a Scanner Log (Web Menu Only)

Acquire a scanner log.

Administrator settings > System management > Log output setting

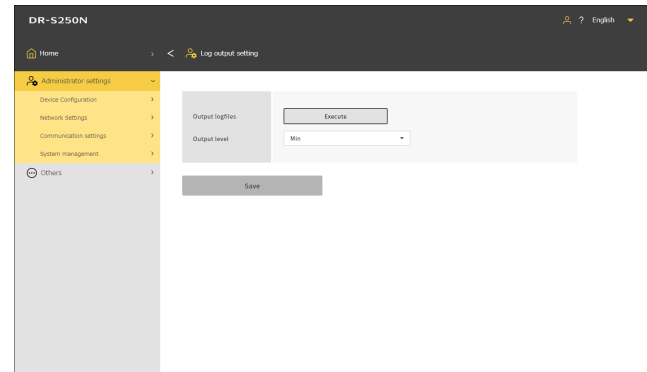

Output level

Set the amount of information in a log file.

Click [Execute] to acquire a log file in ZIP format.

Temporarily Disabling Double Feed Detection (Settings Menu Only)

Temporarily disable the double feed detection function. When scanning with a job for which the double feed detection function is enabled, make this setting if you want to temporarily disable the function.

This is convenient when you need to scan a document different from the usual one that is likely to cause a double feed, using the same job. Once scanning is completed, the setting made here will return to the original one.

Settings Menu > Scan Settings > Detect Double Feed

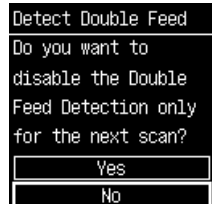

Temporarily Setting Passport Mode (Settings Menu Only)

Temporarily enable passport mode.

When scanning with a job for which passport mode is disabled, make this setting if you want to temporarily enable the function.

This is convenient when you need to scan a document different from the usual one that is thick like a passport, using the same job.

Once scanning is completed, the setting made here will return to the original one.

Settings Menu > Scan Settings > Passport

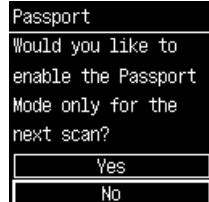

Displaying Information about the Scanner

Display various pieces of information about the scanner.

For information about the network, refer to “Displaying Network Information” (See p. 95).

Displaying information about the scanner

Others > Device information

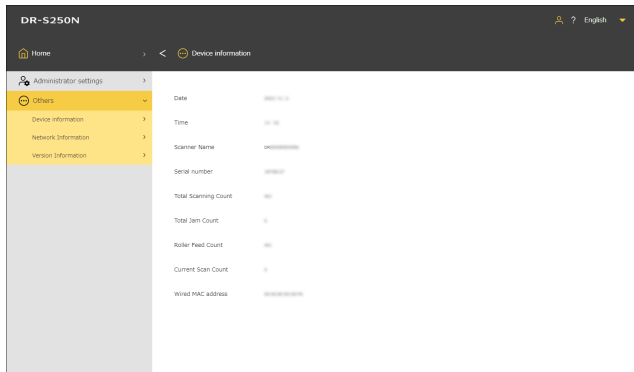

Items to be displayed

- Date
- Time
- Scanner Name
- Serial number
- Total Scanning Count
- Total Jam Count
- Roller Feed Count
- Current Scan Count
- Wired MAC address

Settings Menu > Device Configuration > Device Information

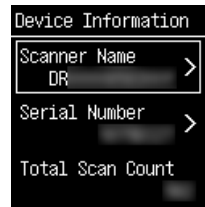

Items to be displayed

- Scanner Name
- Serial Number
- Total Scan Count
- Roller Feed Count
- Current Scan Count
- Total Jam Count
- Wired MAC address

Displaying the version of the firmware, etc.

Others > Version Information

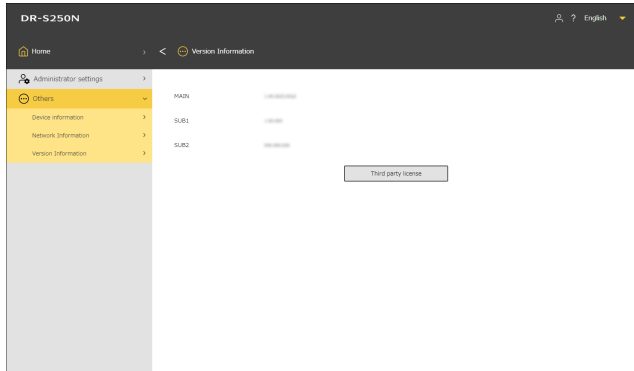

Click [Third party license] to check license information about third party products.

Settings Menu > Version Information

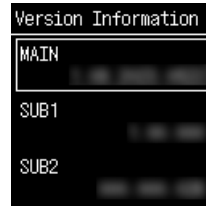

Network Settings

Make settings for the network.



Hint

- Web Menu operating procedure: “[Web Menu Operating Procedure](#)” (See p. 56)
- Settings Menu operating procedure: “[Settings Menu Operating Procedure](#)” (See p. 58)

Setting an IP Address

Set the IP address of the scanner automatically or manually.

Setting an IP address automatically

If you enable DHCP, an IP address will be automatically set with DHCP.

If you disable DHCP, set an IP address manually. “[Setting an IP address manually](#)” (See p. 85)



Hint

For an IP address to be set with DHCP, a DHCP server must be operating within a subnetwork.

Administrator settings > Network Settings > IPv4 Address

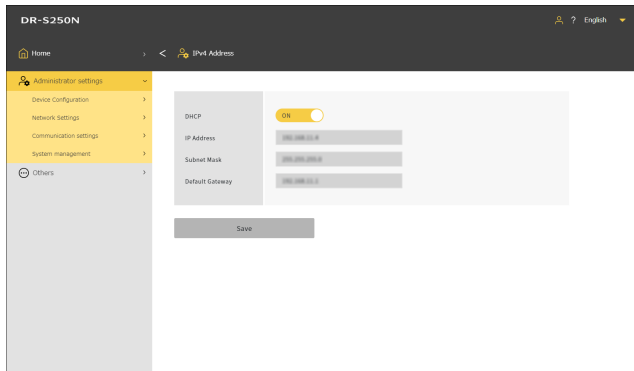

Settings Menu > Network Settings > IP Address Settings > IPv4

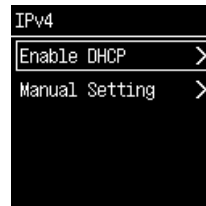

Select [Enable DHCP].

DHCP

Specify whether to enable or disable DHCP.

Click [Save] to save the settings.

Setting an IP address manually

If you disable DHCP, set each item.

IP Address

Set the IP address of the scanner.

The value must be four decimal numbers separated by dots and expressed in the [xxx.xxx.xxx.xxx] format.

! IMPORTANT

If the entered IP address is "0.0.0.0", "255.255.255.255", "127.xxx.xxx.xxx", or "169.254.xxx.xxx", a warning screen is displayed and the entry is rejected.

Subnet Mask

Set the subnet mask of the scanner.

The value must be four decimal numbers separated by dots and expressed in the [xxx.xxx.xxx.xxx] format. When set to [0.0.0.0], a subnet mask appropriate for the IP address is automatically used.

! IMPORTANT

If the entered subnet mask is not a contiguous left-justified value, a warning screen is displayed and the entry is rejected.

Default Gateway

Set the IP address of the scanner gateway.

The value must be four decimal numbers separated by dots and expressed in the [xxx.xxx.xxx.xxx] format. Also, the gateway needs to be running in the same subnetwork as the scanner.

If [0.0.0.0] is set, this setting is disabled.

! IMPORTANT

If the entered default gateway is "0.0.0.0", "255.255.255.255", "127.xxx.xxx.xxx", "169.254.xxx.xxx", a warning screen is displayed and the entry is rejected.

Administrator settings > Network Settings > IPv4 Address

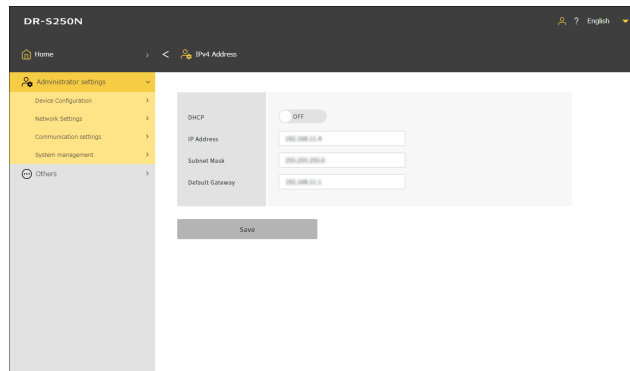

Click [Save] to save the settings.

Settings Menu > Network Settings > IP Address Settings > IPv4

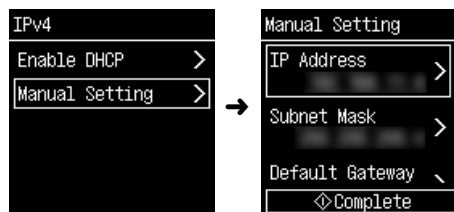

Searching for the Scanner via the Network (Enabling mDNS)

Enable/disable multicast DNS.

This setting allows scanning applications to search for and automatically connect to the scanner. Usually, enable it.

When the setting is disabled, you must manually specify the scanner using its assigned IP address to scan from the scanning application.

Administrator settings > Device Configuration > mDNS

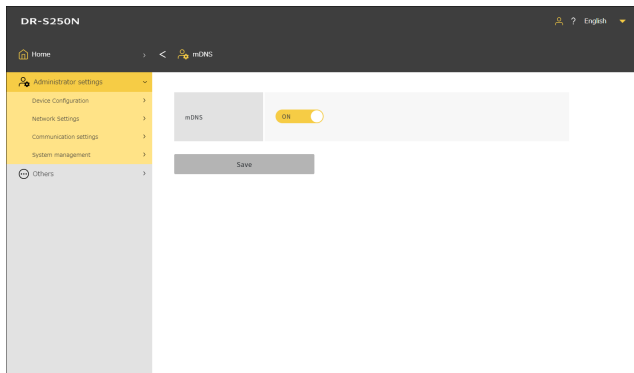

Click [Save] to save the settings.

Settings Menu > Device Configuration > mDNS

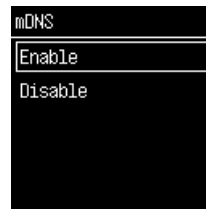

Performing Management Using SNMP (Web Menu Only)

Make this setting if you want to monitor the scanner via a network, using SNMP.

Administrator settings > Device Configuration > SNMP

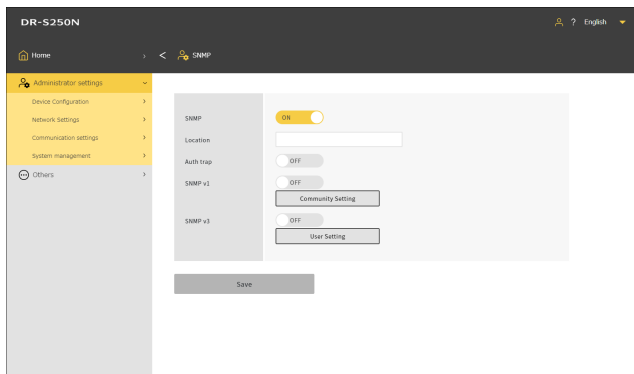

Click [Save] to save the settings.

SNMP

Sets the SNMP function to enabled/disabled.

Location

Input the location where the scanner is installed.

Auth trap

Sets the SNMP authentication trap function to enabled/disabled. By setting this to [ON], if an SNMP request is received from a community that is not registered in [Community Setting], then a message is sent to the trap destination.

SNMPv1

Sets the SNMP v1 support function to enabled/disabled.

Community Setting

Displays the [Manage SNMP Communities] screen.

[“Editing/adding SNMP communities” \(See p. 88\)](#)

[“Deleting an SNMP community” \(See p. 89\)](#)

SNMPv3

Sets the SNMP v3 support function to enabled/disabled.

User Setting

Displays the [Manage SNMP Users] screen.

[“Editing/adding SNMP users” \(See p. 89\)](#)

[“Deleting SNMP users” \(See p. 90\)](#)

Editing/adding SNMP communities

- 1 Click [Community Setting] on the [SNMP] screen.**
The [Manage SNMP Communities] screen appears.
- 2 To edit a registered community, click the list. If you want to create a new community, click .**
Up to three communities can be registered.

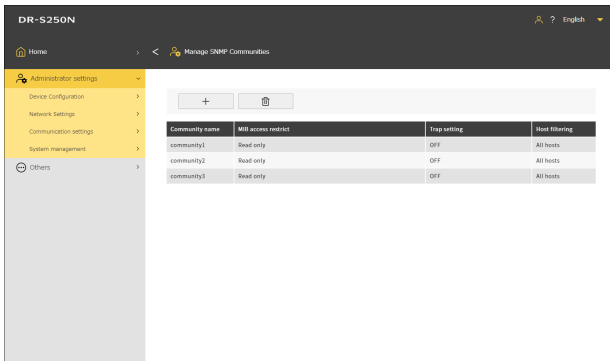

The [Edit SNMP Communities] screen appears.

- 3 Set each item.**

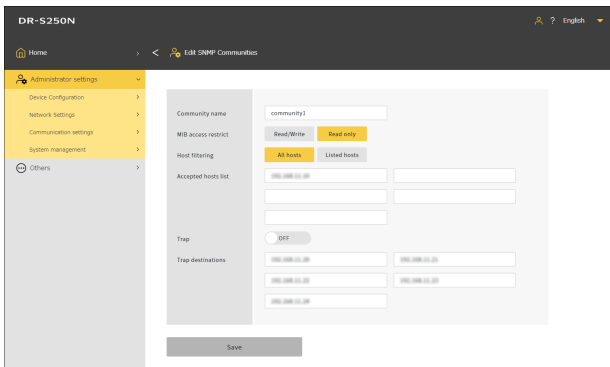

Community name

Set a community name within 32 characters.

You can use single-byte letters, numbers, hyphens, and underbars. An error appears when you click [Save] if the name is already being used or contains illegal characters.

MIB access restrict

Set the privileges for accessing MIB.

Read/Write	Permits reading/writing from/to MIB.
Read only	Permits only reading from MIB.

Host filtering

Sets permission to access the host.

All hosts	Permits access to all hosts.
Listed hosts	Permits access only to hosts specified in [Accepted hosts list].

Accepted hosts list

To specify a host to be accessed, input its IP address or computer name.

You can specify a maximum of 5. You can input up to 64 characters in each line.

Trap

Select Enable/Disable for trap setting.

Trap destinations

To specify a host to be targeted for trap setting, input its IP address or computer name. You can specify a maximum of 5. You can input up to 64 characters in each line.

- 4 Click [Save].**

Deleting an SNMP community

1 Click [Community Setting] on the [SNMP] screen.
The [Manage SNMP Communities] screen appears.

2 Click  .
The [Delete SNMP Community] screen appears.

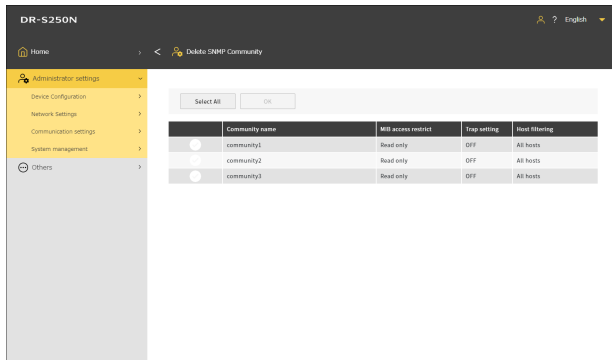

3 Check the community you want to delete. To select all communities, click [Select All].

4 Click [OK].
The selected community is deleted.

Editing/adding SNMP users

1 Click [User Setting] on the [SNMP] screen.
The [Manage SNMP Users] screen appears.

2 To edit a registered user, click the list. If you want to create a new user, click  .
Up to five users can be registered.

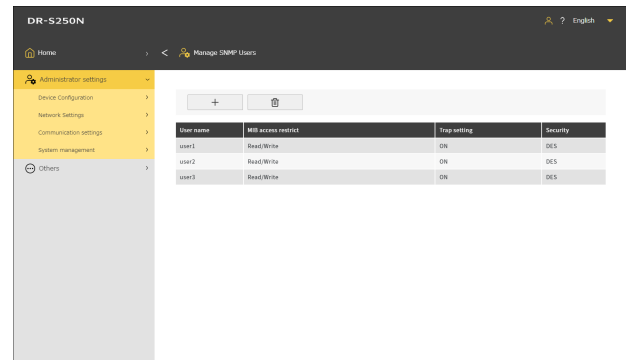

The [Edit SNMP Users] screen appears.

3 Set each item.

The screenshot shows the 'Edit SNMP Users' configuration page. The left sidebar contains a menu with 'Administrator settings' expanded, showing 'Device Configuration', 'Network Settings', 'Communication settings', 'System management', and 'Others'. The main content area has the following fields: 'User name' (text input with 'user1'), 'MIB access restrict' (radio buttons for 'Read/Write', 'Read only', 'None', 'SNMP'), 'Authentication algorithm' (text input with 'None'), 'Authentication password' (text input), 'Encryption algorithm' (radio buttons for 'DES', 'AES'), 'Encryption password' (text input), 'Trap' (checkbox labeled 'ON'), and 'Trap destinations' (three text input fields). A 'Save' button is located at the bottom center.

User name

Set a user name within 32 characters. You can use single-byte letters, numbers, hyphens, and underbars. An error appears when you click [Save] if the name is already being used or contains illegal characters.

MIB access restrict

Set the privileges for accessing MIB.

Read/Write	Permits reading/writing from/to MIB.
Read only	Permits only reading from MIB.

Authentication algorithm

Specify the authentication method.

Authentication password

Set an authentication password using 8 to 16 characters. You can use single-byte letters, numbers, hyphens, and underbars. An error appears when you click [Save] if you input any illegal characters.

Encryption algorithm

Specify the encryption method.

Encryption password

Set an encrypted password using 8 to 16 characters. You can use single-byte letters, numbers, hyphens, and underbars. An error appears when you click [Save] if you input any illegal characters.

Trap

Select Enable/Disable for trap setting.

Trap destinations

To specify a host to be targeted for trap setting, input its IP address or computer name. You can specify a maximum of 10. You can input up to 64 characters in each line.

4 Click [Save].

Deleting SNMP users

1 Click [User Setting] on the [SNMP] screen.

The [Manage SNMP Users] screen appears.

2 Click .

The [Delete SNMP User] screen appears.

The screenshot shows the 'Delete SNMP User' configuration page. The left sidebar is the same as in the previous screenshot. The main content area has a 'Select All' button and an 'OK' button at the top. Below them is a table with the following data:

	User name	MIB access restrict	Trap setting	Security
<input type="radio"/>	user1	Read/Write	ON	DES
<input type="radio"/>	user2	Read/Write	ON	DES
<input type="radio"/>	user3	Read/Write	ON	DES

3 Check the user you want to delete. To select all users, click [Select All].

4 Click [OK].
The selected user is deleted.

Make It Possible to Send Images by Email (Setting a Mail Server) (Web Menu Only)

To send scanned images as emails, you must set the SMTP server. Set a connection to the SMTP server.

Administrator settings > Communication settings > Mail server

Protocol

Set the protocol for communication with the mail server.

SMTP	Sends communication content without encryption.
SMTPS	Encrypts and sends the communication content by using SSL/TLS. A dedicated port number separate from the one for SMTP is required.
STARTTLS	Encrypts and sends the communication content by using SSL/TLS. Unlike with SMTPS, no dedicated port number is required.

Server Address

Set the IP address of the SMTP server.

Port Number

Set the port number used for communication with the SMTP server.

SMTP authentication

Specify whether authentication is required to communicate with the SMTP server.

You can specify whether to enable or disable it if you select [SMTP] for [Protocol].

It is always enabled if you select [SMTPS] or [STARTTLS].

Upon completion of the setting, click [Connection test] to check if a connection can be made to the mail server properly.

Click [Save] to save the settings.

Increasing the Security of an SFTP Connection (Setting a Secret Key) (Web Menu Only)

You can set a secret key if you select SFTP as the protocol for sending scanned images to the FTP server.

Administrator settings > Communication settings > SFTP server

- 1 Click [...] and select a secret key file.
- 2 Click [Execute].
The secret key file is uploaded and the file name is displayed.

Managing Root Certificates (Web Menu Only)

A root certificate is used to confirm whether the destination server is used to confirm whether the destination server is proper. If you set the following as the scan image output destination, an error occurs if no root certificate is registered.

Output destination	Protocol
FTP server	SFTP or FTPS
Mail	SMTPTS or STARTTLS

Administrator settings > System management > Root Certificate

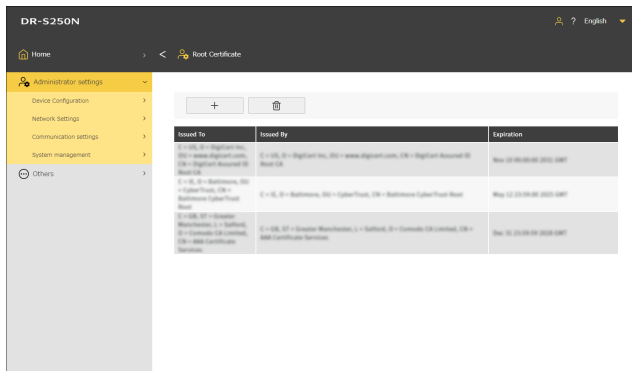

A registered root certificate is displayed.

Adding root certificates

- 1 Click .
The [Add root certificate] screen appears.

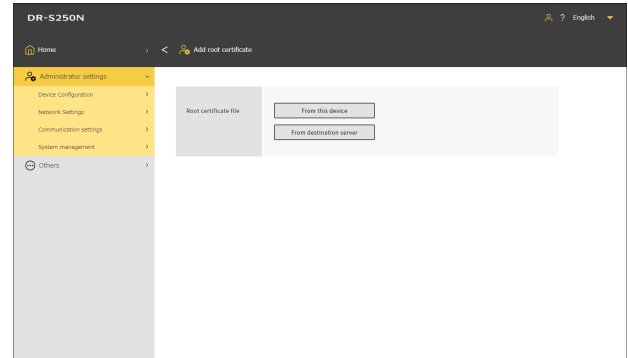

- 2 To add from the device on which the Web Menu is displayed, click [From this device]. To add from the destination server, click [From destination server].

If you select [From this device]

- 1 Click [...] and select a certificate file.
- 2 Click [Execute].
The root certificate is added.

If you select [From destination server]

DR-S250N

Home > < Add root certificate

Administrator settings

Device Configuration

Network Settings

Communication settings

System management

Others

Server Type: FTP

Server Address: _____

Port Number: _____

Execute

Server Type

For FTP transmission, select [FTP]. For mail transmission, select [SMTP].

Server Address

Enter the IP address of the destination server.

Port Number

Set the port number used for communication with the server.

Click [Execute] to add the root certificate.

Deleting root certificates

1 Click  .

The [Delete root certificate] screen appears.

DR-S250N

Home > < Delete root certificate

Select All OK

	Issued To	Issued By	Expiration
<input type="radio"/>	C=US, O=Digital Sign, OU=www.digitalsign.com, CN=Digital Signer @ Root CA	C=US, O=Digital Sign, OU=www.digitalsign.com, CN=Digital Signer @ Root CA	Nov 12 2016 08:28:00 GMT
<input type="radio"/>	C=US, O=Ballistics, OU=Cable Trust, CN=Ballistics CableTrust Root	C=US, O=Ballistics, OU=CableTrust, CN=Ballistics CableTrust Root	May 12 2016 08:28:00 GMT
<input type="radio"/>	C=US, O=Global Authentication, CN=Global, O=Cumulus, CN=Global Certificate Services	C=US, O=Global Authentication, CN=Global, O=Cumulus, CN=Global Certificate Services	May 12 2016 08:28:00 GMT

2 Check the root certificate you want to delete. To select all root certificates, click [Select All].

3 Click [OK].

The selected root certificate is deleted.

Displaying Network Information

Display information about the network of the scanner.

Others > Network Information

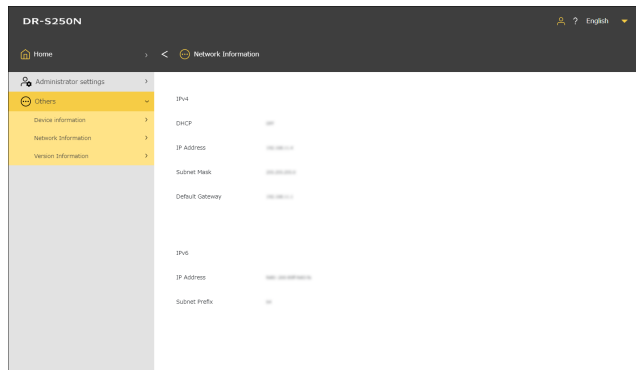

Items to be displayed

IPv4

- DHCP
- IP Address
- Subnet Mask
- Default Gateway

IPv6

- IP Address
- Subnet Prefix

Settings Menu > Network Settings > Network Information

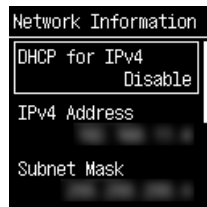

Items to be displayed

- DHCP for IPv4
- IPv4 Address
- Subnet Mask
- IPv4 Default Gateway
- IPv6 Address
- Subnet Prefix

Security Settings

Make settings for security.



Hint

- Web Menu operating procedure: “Web Menu Operating Procedure” (See p. 56)
- Settings Menu operating procedure: “Settings Menu Operating Procedure” (See p. 58)

Using a PIN Code when Logging In

Make this setting when you want to use a PIN code when logging in to the scanner.

The PIN code consists of four digits, ranging from 0 to 9.

Setting a PIN code

Administrator settings > Device Configuration > PIN

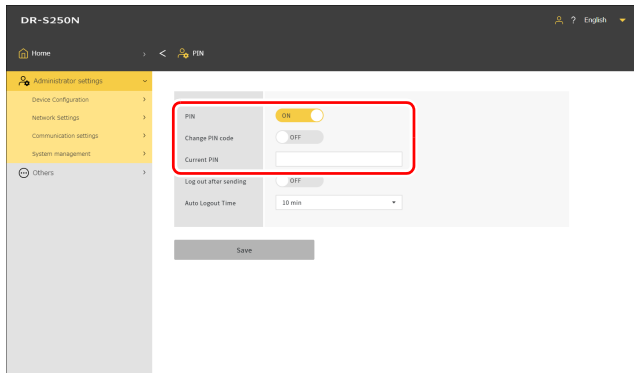

The initial setting of [Current PIN] is “0000”.
Click [Save] to save the settings.

Settings Menu > Device Configuration > Security > PIN Setting

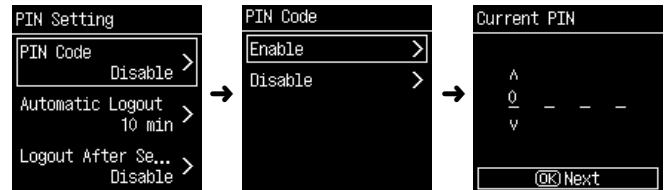

Enter the current PIN code. The initial setting is “0000”.
If authentication is successful, the message “Would you like to set a new PIN code?” appears. If you want to change the PIN code, select [Yes]. Otherwise, select [No].
If you select [Yes], set a new PIN code on the new PIN code input screen. For confirmation, enter the new PIN code once again.

Automatically logging out after sending scanned images

Set the function for automatically logging out after sending scanned images. You must enter a PIN code to log in.

Administrator settings > Device Configuration > PIN

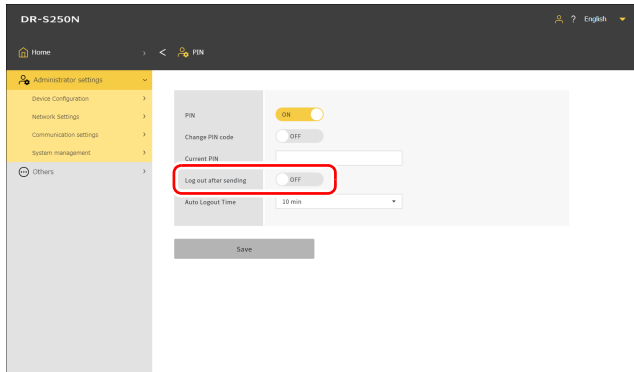

Click [Save] to save the settings.

Hint

The settings made here are linked with the settings in [“Automatically Logging Out after Sending Scanned Images”](#) (See p. 105).

Settings Menu > Device Configuration > Security > PIN Setting > Logout After Sending



Setting the time for automatic logout

Set the time for automatic logout when no operations are performed on the scanner for a certain period of time. You must enter a PIN code to log in.

Setting value

1 min / 2 min / 3 min / 4 min / 5 min / 10 min / 30 min / 60 min / 90 min / 120 min

Administrator settings > Device Configuration > PIN

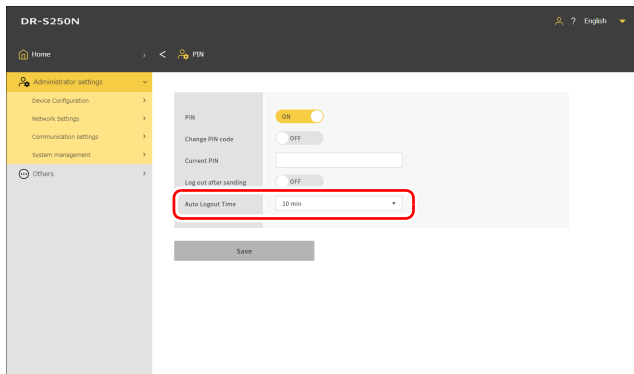

Click [Save] to save the settings.



Hint

The logout time set here is linked with the time set in ["Setting the Time for Automatic Logout"](#) (See p. 106).

Settings Menu > Device Configuration > Security > PIN Setting > Automatic Logout



Installing an SSL Server Certificate (Web Menu Only)

When you access the Web Menu with “https://”, a warning “The connection is not private” may be displayed on the web browser.

For general users:
Contact your administrator.

For administrators:
An appropriate SSL server certificate is not installed in the Web Menu.
Refer to the following to install it.

Administrator settings > Device Configuration > Server Certificate

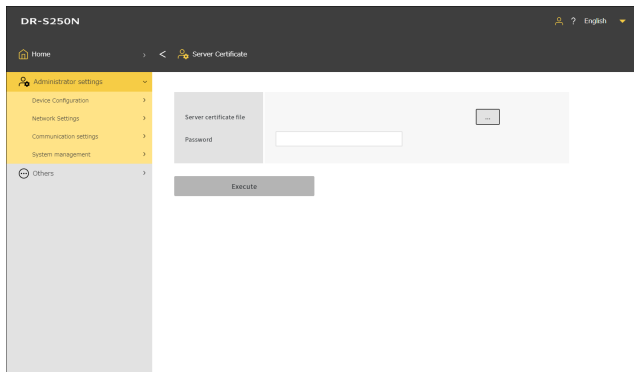

- 1** Click [...] and specify a certificate file (pfx file) in the file selection dialog box.
- 2** Enter a password.
- 3** Click [Execute].
The server certificate is installed.

Setting an Administrator Password

Set the administrator password for the scanner.

The password set here is used in the following situations.

- When you want to display the [Administrator settings] screen of the Web Menu.
- When asked for an administrator password while attempting to change the settings on the Settings Menu.

Set the password with up to 32 single-byte characters, including uppercase and lowercase English letters, numbers, and symbols.



Hint

The administrator password at the time of factory shipment is written on the label affixed to the scanner.

Administrator settings > System management > Administrator Password

The screenshot shows the web interface for the DR-S250N scanner. The top navigation bar includes 'Home', '<', and 'Administrator Password'. A left sidebar menu lists 'Administrator settings', 'Device Configuration', 'Network settings', 'Communication settings', 'System management', and 'Others'. The main content area is titled 'Administrator Password' and contains three input fields: 'Current Password', 'New Password', and 'New Password(Confirmation)'. A 'Save' button is located at the bottom of the form.

Click [Save] to save the settings.

Settings Menu > Device Configuration > Security > Admin Password Setting

The screenshot shows the 'Enter the Admin PASS' screen on the scanner's settings menu. It features a password input field, a keyboard icon, and a 'Next' button. Below the 'Next' button is a 'Complete' button with a diamond icon.

If authentication is successful, the message “Would you like to set a new administrator password?” appears. If you want to change the administrator password, select [Yes]. Otherwise, select [No]. If you select [Yes], set a new administrator password on the new administrator password input screen. For confirmation, enter the new administrator password once again.

Web Menu Settings

Make settings for the Web Menu.



Hint

Web Menu operating procedure: “[Web Menu Operating Procedure](#)” (See p. 56)

Changing the Data to Be Displayed on the Display of the Scanner (Web Menu Only)

By using the setting file for the SDK for UI customization, you can change the data to be displayed on the display of the scanner. For details of this function, refer to the document supplied with the SDK for UI customization.

Administrator settings > System management > SDK for UI customization

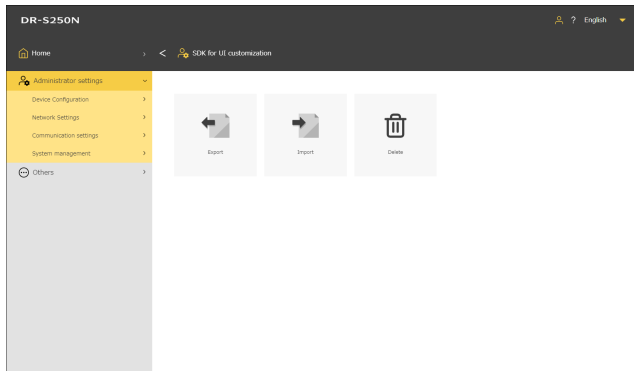

Exporting the setting file

1 Click [Export].

The SDK for UI customization setting file is exported in ZIP format.

Importing the setting file

1 Click [Import].

The Import screen appears.

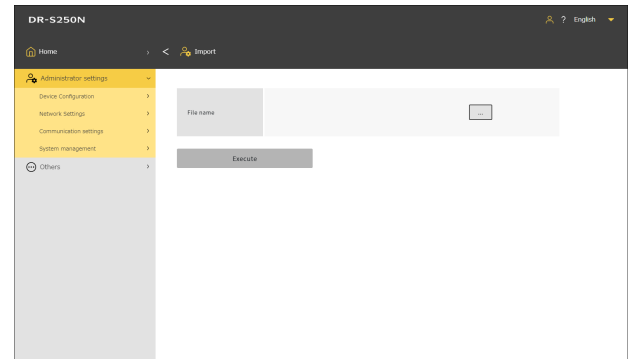

2 Click [...] and specify the SDK for UI customization setting file in the file selection dialog box.

3 Click [Execute].

The SDK for UI customization setting file is imported.

Deleting the setting file

1 Click [Delete].

The imported SDK for UI customization setting file is deleted and the appearance resets to its initial state.

Setting CaptureOnTouch Lite Web (Web Menu Only)

You can set the CaptureOnTouch Lite Web function, which enables scanning from the Web Menu. For details of the CaptureOnTouch Lite Web function, refer to “Scanning with CaptureOnTouch Lite Web” (See p. 35).

Administrator settings > System management > CaptureOnTouch Lite Web Settings

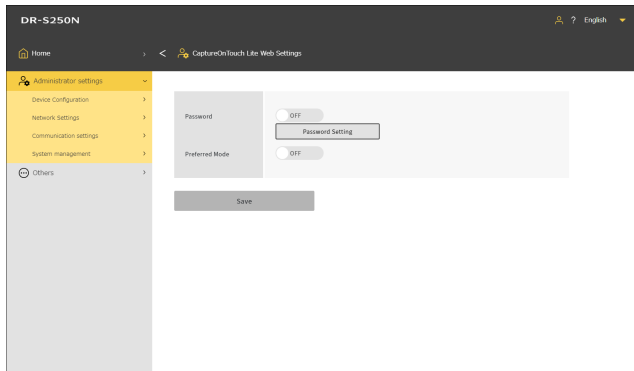

Click [Save] to save the settings.

Password

When you turn it ON, a password is required to use the CaptureOnTouch Lite Web function.

Password Setting

Displays the [CaptureOnTouch Lite Web Password] screen. The initial setting is “0000”.

Preferred Mode

When you turn it ON, other users cannot use the scanner while you are making scan settings with the CaptureOnTouch Lite Web function.

Setting a password

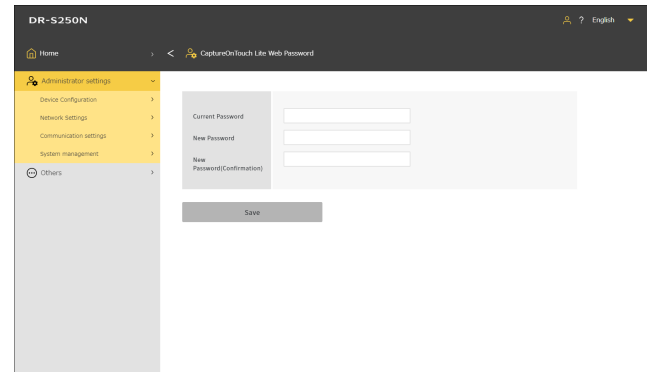

Click [Save] to save the settings.

Setting the COT Admin Server Function

Make settings for the connection to the COT Admin server for use with COT Admin.
For details of COT Admin, refer to the “COT Admin Server User Manual”.

Setting the COT Admin Server

Administrator settings > Communication settings > COT Admin Server

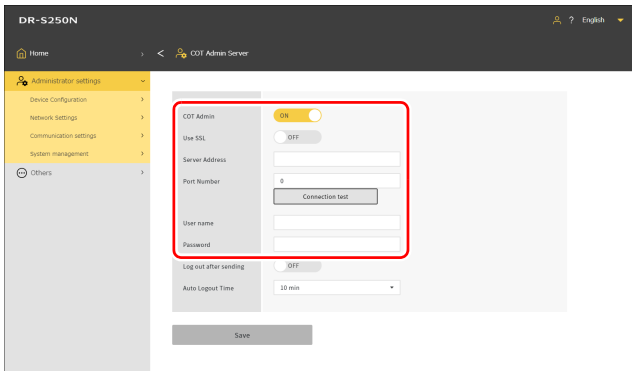

COT Admin

Enable/disable the COT Admin server function.

Use SSL

Enable/disable encryption of the communication with COT Admin server.

Server Address

Set the IP address of the COT Admin server.

Port Number

Set the port number used for communication with the COT Admin server.

User name

Set the user name used for communication with the COT Admin server.

Password

Set the password used for communication with the COT Admin server.

Upon completion of the setting, click [Connection test] to check if a connection can be made to the COT Admin server properly.

Click [Save] to save the settings.

Settings Menu > Network Settings > COTAdmin Settings > Server Settings



Enable COT Admin

Enable/disable the COT Admin server function.

Server Address

Set the IP address of the COT Admin server.

Port Number

Set the port number used for communication with the COT Admin server.

SSL

Enable/disable encryption of the communication with COT Admin server.

User Name

Set the user name used for communication with the COT Admin server.

Password

Set the password used for communication with the COT Admin server.

Upon completion of the setting, conduct the connection test to check if a connection can be made to the COT Admin server properly.

Settings Menu > Network Settings > COTAdmin Settings > Connection Test



Automatically Logging Out after Sending Scanned Images

Set the function for automatically logging out of the COT Admin server after sending scanned images.

Administrator settings > Communication settings > COT Admin Server

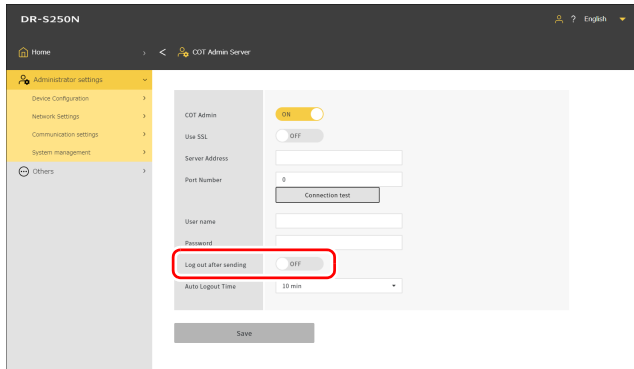

The screenshot shows the 'COT Admin Server' settings page. The 'Log out after sending' toggle is currently set to 'OFF' and is highlighted with a red rectangle. Other settings include 'COT Admin' (ON), 'Use SSL' (OFF), 'Server Address', 'Port Number', 'User name', 'Password', and 'Auto Logout Time' (10 min). A 'Save' button is at the bottom.

Click [Save] to save the settings.

Hint

The settings made here are linked with the settings in [“Automatically logging out after sending scanned images”](#) (See p. 97).

Settings Menu > Network Settings > COTAdmin Settings > Server Settings > Logout After Sending

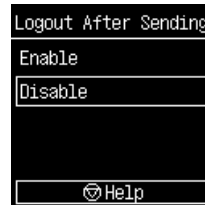

The screenshot shows the 'Logout After Sending' settings menu. The 'Disable' option is selected, and the 'Help' button is at the bottom.

Setting the Time for Automatic Logout

Set the time for automatically logging out of the COT Admin server when no operations are performed on the scanner for a certain period of time.

Setting value

1 min / 2 min / 3 min / 4 min / 5 min / 10 min / 30 min / 60 min / 90 min / 120 min

Administrator settings > Communication settings > COT Admin Server

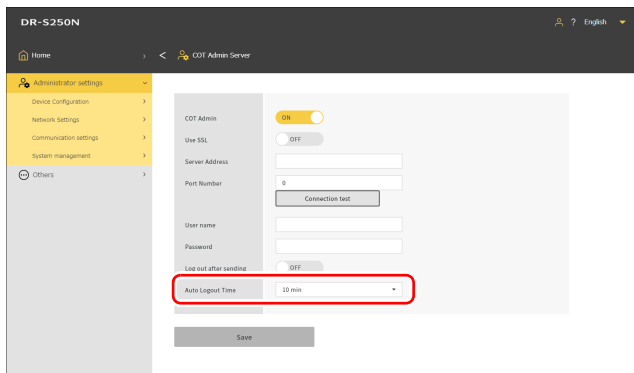

Settings Menu > Network Settings > COTAdmin Settings > Server Settings > Automatic Logout



Click [Save] to save the settings.



Hint

The logout time set here is linked with the time set in [“Setting the time for automatic logout”](#) (See p. 98).

Registering a Job in the Scanner (for Administrators)

You can create a job and register it in the scanner. Users can scan merely by selecting pre-registered jobs.

Creating/Editing/Registering Jobs in the Web Menu

1 Display the Web Menu. (See p. 34)

2 Click [Edit “jobs on scanner”].

The [Show “jobs on scanner”] screen appears.

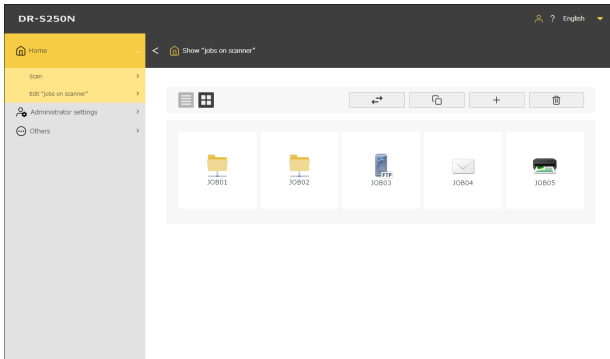

	Switch jobs between list view and icon view.
	Imports/exports jobs.
	Copies jobs. This is convenient when you want to create a new job based on an existing job.
	Adds a new job.

	Deletes a job.
--	----------------

3 Click . To edit an existing job, click the job you want to edit.

The [Edit “jobs on scanner”] screen appears.

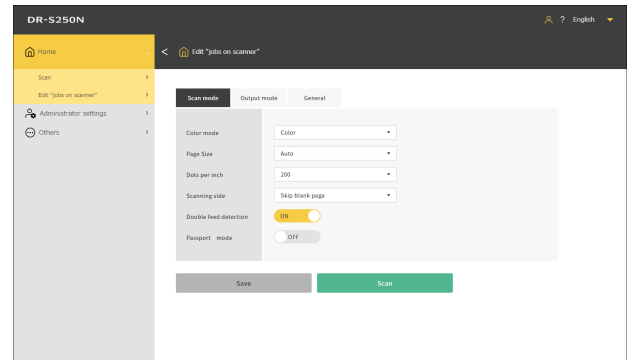

4 Make settings on each tab.

For detailed settings, refer to the following:

Scan mode: “[Setting Items for Scan Mode](#)” (See p. 108)

Output mode: “[Setting Items for Output Mode](#)” (See p. 108)

General: “[Other Setting Items](#)” (See p. 112)

5 Click [Save].

The contents of the job are registered in the scanner.

Click [Scan] to scan with the settings of the job.

Setting Items for Scan Mode

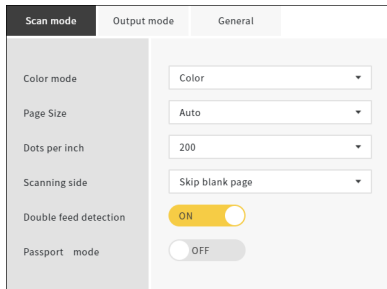

Color mode

Select the color mode for scanning the document from the following:

Color	Scans the document in color.
Grayscale	Scans the document in grayscale.
Black and White	Scans the document in black and white.

Page Size

Specify the paper size of the document to be scanned.
If you select [Auto], the scanner will detect the size of the document and scan it.

Dots per inch

Specify the resolution of the scan. The unit is dpi.

Scanning side

Skip blank page	If there are blank pages in the document, skip those pages when scanning.
Simplex	Scans only one side of the document.
Duplex	Scans both sides of the document.

Double feed detection

Turn ON/OFF the double feed detection function.

Passport mode

Scan the document with settings appropriate for a passport.
When it is turned ON, [Double feed detection] is turned OFF.

Setting Items for Output Mode

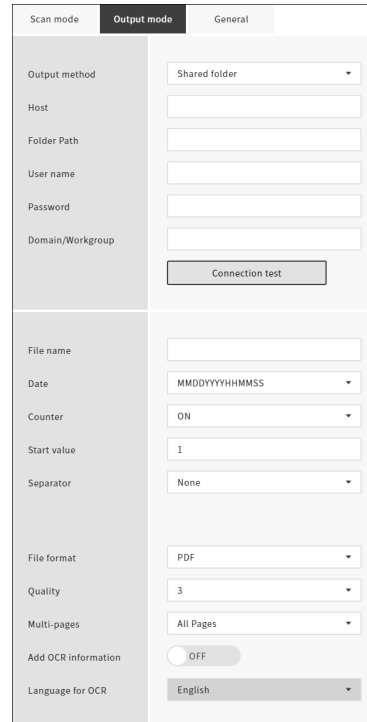

Output method

Shared folder	Sends the scanned image to the shared folder.
FTP	Sends the scanned image to the FTP server.

Mail	Sends the scanned image by attaching it to an email.
Print	Sends the scanned image to a printer that supports the FTP protocol.

Sending to the shared folder

Host

Enter the host name or IP address of the shared folder.

Folder Path

Enter the path of the shared folder.

Enter it in the following format: “shared folder’s IP address\folder path” or “shared folder name\folder path”.

Example: IP address\guest\share_folder or adminPC\guest\share_folder

User name

Enter the user name for accessing the shared folder.

If the shared folder is in the domain environment, enter it in the following format: “user name@domain name” or “domain name\user name”.

Example: admin@domain or domain\admin

Password

Enter the password for accessing the shared folder.

Domain/Workgroup

Enter the name of the domain or workgroup to which the shared folder belongs.

Upon completion of the setting, click [Connection test] to check if a connection can be made to the shared folder properly.

Sending to the FTP server

Protocol

Select the protocol to use.

FTP	Sends communication content without encryption.
FTPS (Explicit)	Encrypts the communication content in Explicit mode and sends it.
FTPS (Implicit)	Encrypts the communication content in Implicit mode and sends it.

SFTP	Encrypts the communication content, using an SSH connection, and sends it.
-------------	--

 **Hint**

If sending with SFTP, you can set a secret key. For details, [“Increasing the Security of an SFTP Connection \(Setting a Secret Key\) \(Web Menu Only\)”](#) (See p. 92).

Server Address

Enter the host name or IP address of the FTP server.

Folder Path

Enter the path to the folder of the destination FTP server. Enter it in the format of “/FTP server name/folder path”. Example: /upload/share

Port Number

Specify the port number to use with the destination FTP server.

Mode

Passive	Mode in which a connection request is made from scanner to FTP server.
Active	Mode in which a connection request is made from FTP server to scanner.

Authentication Method

Specify which of a password or a secret key to use with the authentication method. You can specify if when you select [SFTP] for [Protocol].

User name

Enter the user name for connecting to the destination FTP server.

Password

Enter the password for connecting to the destination FTP server.

Use passphrase

If you select [Secret key] for the authentication method, turn it ON if you want to use a passphrase.

Passphrase

Enter the passphrase to use with the secret key.

Fingerprint

Enter the fingerprint of the destination FTP server.

Upon completion of the setting, click [Connection test] to check if a connection can be made to the FTP server properly.

Sending by email

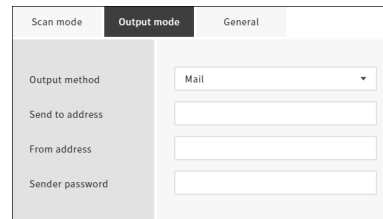

 **IMPORTANT**

To send email, you must connect to the mail server. Refer to [“Make It Possible to Send Images by Email \(Setting a Mail Server\) \(Web Menu Only\)”](#) (See p. 92) to do the settings.

Send to address

Enter the email address of the destination.

From address

Enter the email address of the sender.

Sender password

Enter the password for connecting to the mail server.

Common setting items

File name	<input type="text"/>
Date	MMDYYYYHHMMSS
Counter	ON
Start value	1
Separator	None
File format	PDF
Quality	3
Multi-pages	All Pages
Add OCR information	<input type="radio"/> OFF
Language for OCR	English

File name

Enter the file name of the image to send.

Date

Select the format of the date to add at the end of the file name. If the date is not required, select “None”.

Counter

Turn it ON if you want to add a 4-digit serial number at the end of the file name.

Start value

Set the start value of the counter.

Separator

Select the character to insert between file name, date, and serial number. If the separator is not required, select “None”.

- (single-byte hyphen)	Example: scan-20230701-0012
None	Example: scan202307010012
_ (single-byte underbar)	Example: scan_20230701_0012

File format

Specify the file format of the scanned image to send.

Quality

You can set the image quality on a scale of 1 to 4. Setting it to “1” results in the highest compression rate, reducing the file size of the scanned image, but degrading the image quality. Setting it to “4” results in the lowest compression rate, reducing the degradation of the image quality.



Hint

This is effective when the [Color mode] in [Scan mode] is set to [Color] or [Grayscale].

Multi-pages

Specify the saving method when scanning a document with multiple pages.

All Pages	Saves all pages of the document into one file.
Single Page	Saves each specified number of pages into one file.



Hint

This is effective when [File format] is [PDF] or [TIFF].

Add OCR information

When you turn it ON, the text part of the scanned image is recognized and saved with the text data added.



Hint

This is effective when [File format] is [PDF].

Language for OCR

Set the language to be recognized with [Add OCR information].



Hint

This is effective when [File format] is [PDF].

Sending to the printer

Scan mode | **Output mode** | General

Output method: Print

Server Address: [Input field]

Mode: Passive

User name: [Input field]

Password: [Input field]

Connection test

Server Address

Enter the host name or IP address of the printer.

Mode

Passive	Mode in which a connection request is made from scanner to printer.
Active	Mode in which a connection request is made from printer to scanner.

User name

Enter the user name for connecting to the destination printer.

Password

Enter the password for connecting to the destination printer.

Upon completion of the setting, click [Connection test] to check if a connection can be made to the printer properly.

Other Setting Items

Scan mode | Output mode | **General**

Job number: 6

Title: NEW_JOBTITLE

Icon: [Empty box]

Overwrite file with same name: OFF

Job number

Select the number of the job to be registered in the scanner. Select an unused number.

Title

Enter the name of the job. This name is displayed on the computer.

Icon

Click it to display the [Select icons] screen, so that you can select an icon. For information about adding and deleting icons, refer to ["Managing Icons \(Web Menu Only\)"](#) (See p. 78).

Overwrite file with same name

Set the action to take if the destination has a file with the same name.

ON	Overwrites the existing file.
OFF	Adds a serial number at the end of the file name and saves the file as a file with another name.

Daily Maintenance

Clean the scanner on a regular basis, as described below, to maintain peak scanning quality.

CAUTION

- When cleaning the scanner and the inside of the scanner, turn OFF the power and disconnect the power cord from the power outlet.
- Do not use spray cleaners to clean the scanner. Precision mechanisms, such as the light source, may get wet, and cause a malfunction.
- Never use paint thinner, alcohol, or other organic solvents to clean the scanner. The exterior of the scanner may become deformed, discolored, or melted. It may also cause a fire or electric shock.

Cleaning the Scanner

To clean the outside of the scanner, wipe off any dirt with a cloth that has been dampened with water and thoroughly wrung out, and then wipe the scanner dry with a clean dry cloth.

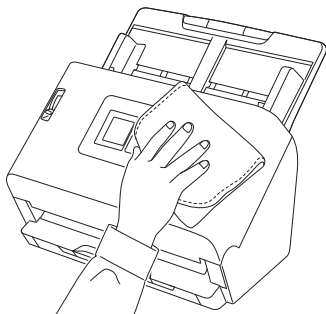

Cleaning the Display

To clean the display, use a soft dry cloth to lightly wipe the surface of the panel, without applying any pressure.

Cleaning the Inside of the Scanner

Dust or paper particles inside the scanner may cause lines or smudges to appear on scanned images. Use compressed air to periodically clean dust and paper particles from the document feed opening and the inside of the scanner. After finishing a large scanning job, turn OFF the scanner and then clean out any paper particles remaining inside the scanner.

Cleaning the Sensor Glass and the Rollers

If scanned images contain streaks, or if the scanned documents become dirty, the sensor glass or rollers inside the scanner may be dirty. Clean them periodically.

- 1 Pull the OPEN lever and pull open the front unit toward you.**

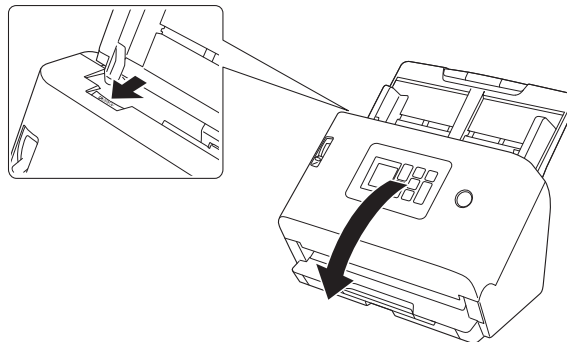

- 2 Use compressed air to remove dust and paper particles from the inside of the scanner.**

3 Wipe any dirt off the scanning glass.

Wipe any dirt off the scanning glass with a cloth that has been dampened with water and thoroughly wrung out, and then wipe the glass dry with a clean, dry and soft cloth.

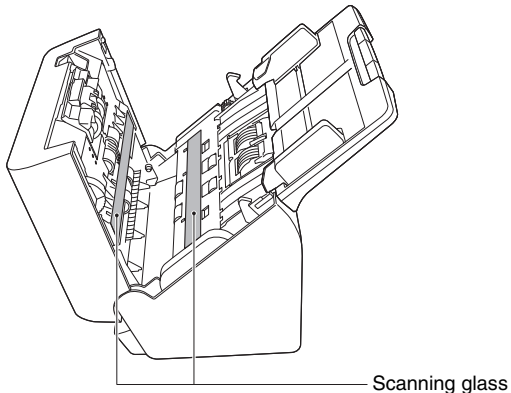

CAUTION

Do not spray water or neutral detergent directly on the scanner. Precision mechanisms, such as the light source, may get wet, and cause a malfunction.

IMPORTANT

- Scratches on the sensor glass may cause marks on the images, as well as feeding errors. If there are scratches on the sensor glass, contact your local authorized Canon dealer or service representative.

- Take care to ensure the anti-static brush in the front unit does not become deformed.

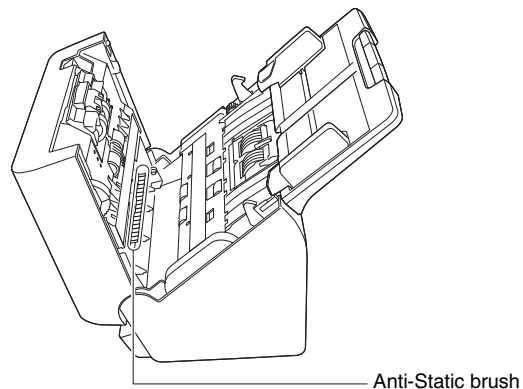

4 Clean the rollers.

Clean the rollers while turning them. Wipe the rollers with a cloth that has been dampened with water and thoroughly wrung out, and then use a clean, dry and soft cloth to wipe away any moisture.

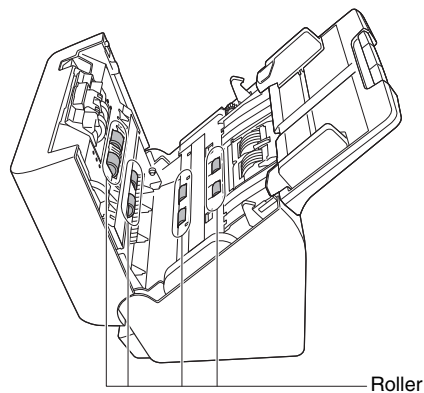

-
- 5** Remove the retard roller and feed roller. (See p. 117, p. 118)

! IMPORTANT

Remove the retard roller and feed roller from the scanner to clean them, and be sure to reattach them to the scanner when cleaning is finished.

-
- 6** Wipe the removed rollers with a cloth that has been dampened with water and thoroughly wrung out.

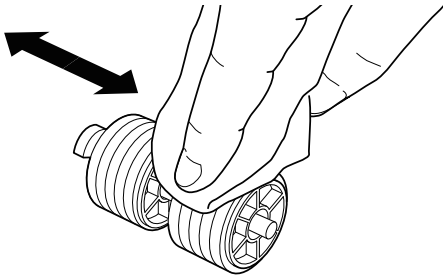

-
- 7** Reattach the retard roller and feeding roller. (See p. 117, p. 118)

-
- 8** Close the front unit by gently pushing it up on both sides until it clicks into place. Make sure that the front unit is completely closed by pushing until you hear a click.

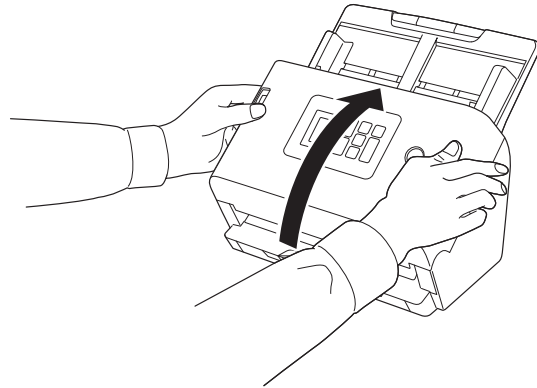

Replacing Consumable Parts

The two rollers (feed roller and retard roller) installed in the scanner are consumable parts. The feed roller and retard roller wear with scanning. If the feed roller and retard roller are worn, documents may not feed correctly and paper jams and double feeds may occur. When the total number of pages fed by the scanner exceeds the number of pages for the service life of the rollers, a message prompting you to replace the rollers is displayed when the computer is started.

Message that appears on the computer

Windows

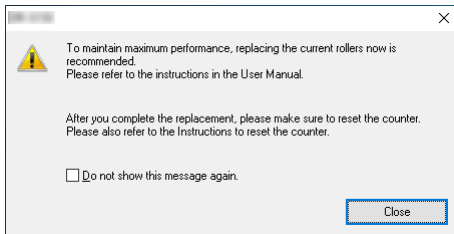

Mac

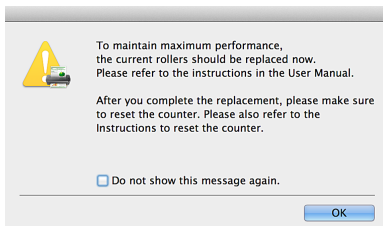

If a message appears on the display

Press the OK key to move to the [Select Job] screen.

The message that appeared on the display can be cleared by resetting the roller counter. Note that, it will always appear whenever the scanner's power is turned on, until you reset the roller counter.

If this message begins to be displayed at startup, purchase an exchange roller kit and replace the worn parts with the consumable parts included in the kit (feed roller and retard roller). [See p. 151](#) for details about the exchange roller kit.

Furthermore, the counter in the scanner that records the number of pages fed also needs to be reset when you replace the rollers. ([See p. 66](#), [p. 68](#))

Hint

Even before it becomes time to replace the rollers, scanned images may become stretched in the vertical direction due to wear of the rollers. If this happens, adjust the reduction ratio. ([See p. 120](#))

Opening and Closing the Front Unit

- 1 Pull the OPEN lever and pull open the front unit toward you.

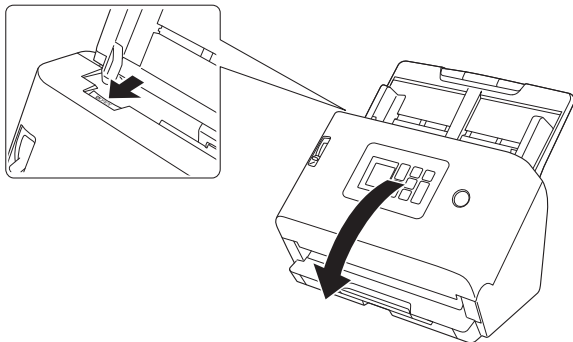

Hint

The location of each of the consumable parts is shown below.

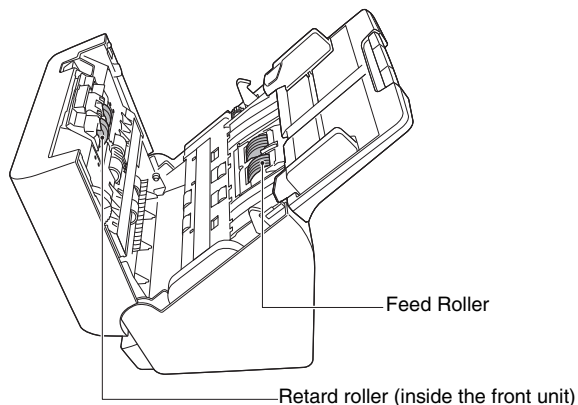

- 2 When closing the front unit, make sure that it is completely closed by gently pressing the left and right until you hear a click.

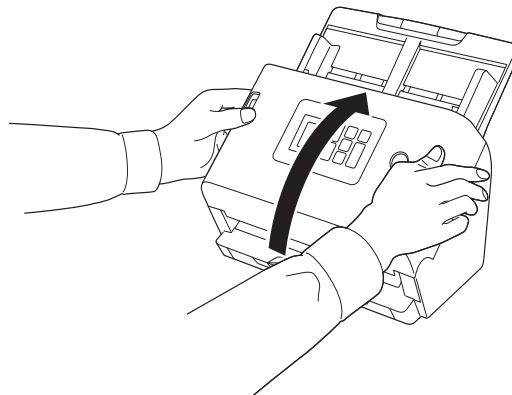

Replacing the Feed Roller

Reset the roller count after replacement of the roller. "[Checking/Resetting the Roller Feed Count](#)" (See p. 66)

- 1 Open the roller cover.

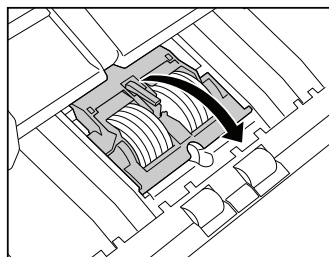

2 Remove the feed roller.

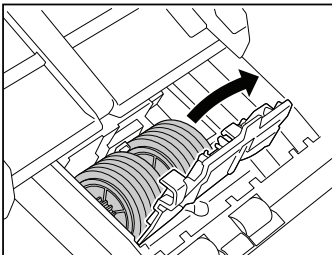

3 Install the new feed roller.

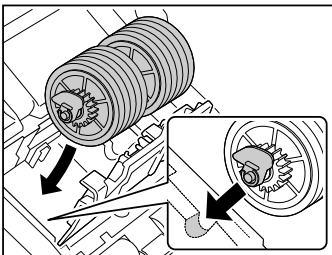

4 Close the roller cover.

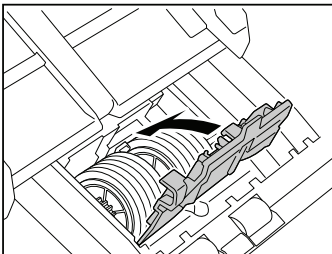

Replacing the Retard Roller

Reset the roller count after replacement of the roller. "[Checking/Resetting the Roller Feed Count](#)" (See p. 66)

1 Open the roller cover.

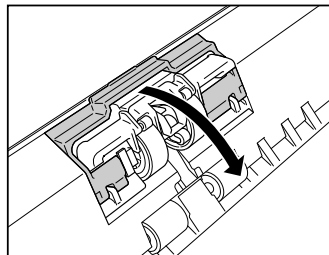

2 Pull the left lever that secures the retard roller to the scanner, and remove the roller.

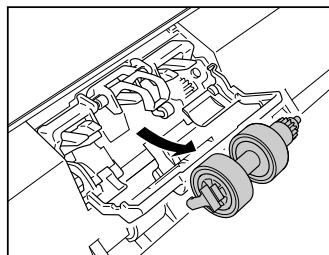
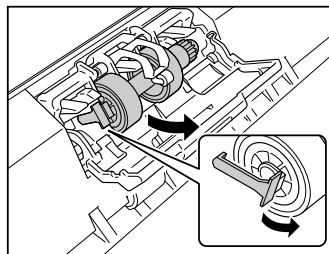

- 3** Check that part A is up and first mount the right side of the new retard roller to the scanner from under part A.

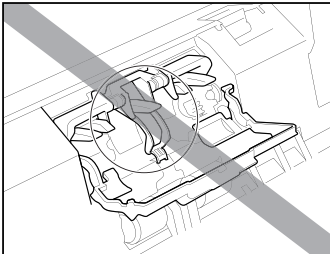
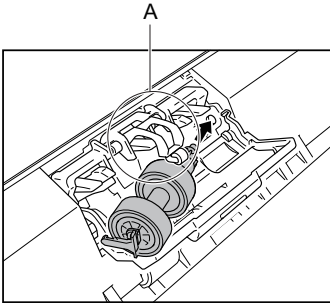

- 4** Push the left side of the retard roller to secure it to the scanner.

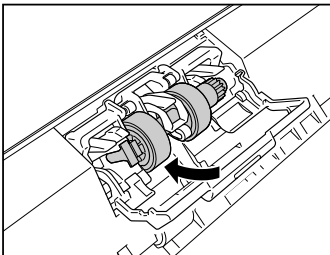

- 5** Close the roller cover.

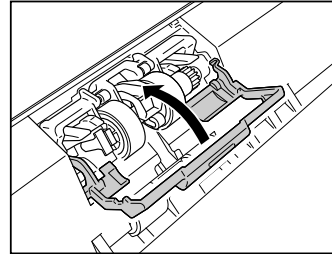

Removing the Document Feed Tray

When you will store or otherwise not use the scanner for a long period of time, remove the document feed tray.

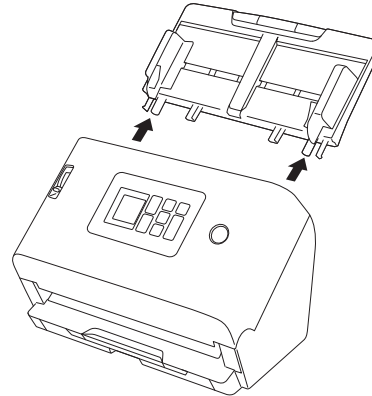

About the Canon imageFORMULA Driver Setting Tool **Windows**

The Canon imageFORMULA Driver Setting Tool can be used to check the information of the scanner, or to configure the maintenance settings.

For details, refer to the Help of this tool.

Configuration of the Canon imageFORMULA Driver Setting Tool

Canon imageFORMULA Driver Setting Tool consists of the following tabs.

[Information] tab

You can check the firmware's version information and scanner information.

[Maintenance] tab

You can reset the counter of the roller, or carry out the shrinkage rate control.

[Control] tab

You can carry out the control settings of hardware and drivers, and perform the read or write of the control settings.

From the configuration of the hardware, you can set the automatic power-off function.

[Diagnosis] tab

You can output or delete the log file.

[Network monitor] tab

You can see the scanners on the network. You can also display a Web Menu screen to make various scanner settings. ["Making settings"](#)

(See p. 55)

IMPORTANT

A USB connection is required to make this setting with the Canon imageFORMULA Driver Setting Tool. When connected via wired LAN, making this setting with the Canon imageFORMULA Driver Setting Tool is ineffective.

Start-up of the Canon imageFORMULA Driver Setting Tool

Click the [Start] button, then click [Canon DR-S200 Series] – [Canon imageFORMULA Driver Setting Tool] in that order. Canon imageFORMULA Driver Setting Tool will start.

When in Trouble

This section provides recommended solutions to common problems.

Problems with the scanner: [See p. 121](#)

Problems with scanning: [See p. 124](#)

Problems with the Web Menu: [See p. 137](#)

Refer also to the Help supplied with the scanner driver and CaptureOnTouch.

Read also “[Frequently Asked Questions](#)” ([See p. 140](#)), which contains frequently asked questions and answers.

If you have a problem that is not solved by the following, contact your local authorized Canon dealer or service representative.

Problems with the Scanner

■ The scanner will not turn on.

The power plug is not connected to a power outlet.	Confirm that the AC adapter is plugged firmly into a power outlet.
The power outlet is not functioning.	Confirm that the power outlet used is functioning. Connect another device to the power outlet and confirm that the power is on.

■ The scanner turns off automatically.

The auto power off function of the scanner is enabled.	When the scanner's auto power off function is enabled, the scanner's power is automatically turned off after 4 hours, regardless of whether a connection is active. Turn the scanner back on, and as necessary, disable the Auto Power Off. (See p. 72)
--	--

■ The scanner is not recognized.

<USB connection>

The power to the scanner is not on.	Confirm that the scanner is turned on. (See p. 20)
The scanner is not properly connected to the computer with a USB cable.	<ul style="list-style-type: none">• Firmly plug in the USB cable connecting the scanner and the computer.• Try using a different USB cable port. If that does not resolve the problem, try using a different USB cable.
The computer's USB interface does not support the scanner.	The scanner cannot be guaranteed to work with all USB interfaces.

A cable other than the supplied USB cable is used.	Confirm that the supplied USB cable is used to connect the scanner to the computer. The scanner cannot be guaranteed to work with all available USB cables.
The scanner is connected to the computer via a USB hub.	Remove the USB hub and connect the scanner directly to the computer.
The scanner driver is not installed.	For use with a USB connection, the scanner driver is required. Refer to the Setup Guide to install the scanner driver.
The scanner is in COT Admin mode.	If the scanner is in COT Admin mode, it is not recognized when a USB connection is made to the computer.

<Wired LAN connection>

The power to the scanner is not on.	Confirm that the scanner is turned on. (See p. 20)
The LAN cable is not properly connected.	Confirm that the LAN cable is properly connected to the LAN port of the scanner, computer, or other network equipment.
The IP address is not specified properly.	Confirm that the IP address and DHCP are enabled/disabled properly. (See p. 84)
The DHCP server is not on the network.	If a DHCP server does not exist on the network, you need to use a static IP address. On the scanner Settings Menu, set the IP address manually. (See p. 85)
The IP address is conflicting with another device.	The specified IP address may already be in use by another device. Contact your network's system administrator to change the IP address.
The scanner name is conflicting with another scanner.	The specified scanner name may already be in use by another device. Contact your network's system administrator to change the scanner name. Be careful not to duplicate the scanner name when more than one scanner is installed.
The scanner driver is not installed.	To use CaptureOnTouch, the scanner driver is required. Refer to the Setup Guide to install the scanner driver.
The IP address or scanner name of the scanner has been changed.	If the IP address or scanner name is changed, it may be necessary to reselect the scanner. Confirm that the correct scanner is selected with the software used and that the correct scanner is operated.
The computer and the scanner are connected to different segments.	If the connected segment is different, then special settings are needed. Use Canon imageFORMULA Driver Setting Tool to set the IP address manually. For specific operating procedures, see the Canon imageFORMULA Driver Setting Tool Help.

<p>The mDNS port is not open in the firewall.</p>	<p>Windows</p> <p>Use the following procedure to configure the firewall and open the mDNS port.</p> <ol style="list-style-type: none"> (1) Click the [Start] button, and then click [Windows System] – [Control Panel]. (2) Click [System and Security]. (3) Click [Windows Defender Firewall]. (4) Click [Advanced settings] to open the [Windows Defender Firewall with Advanced Security] window. (5) Click [Inbound Rules]. (6) Click [New Rule] to open the [New Inbound Rule Wizard]. (7) Click [Custom], and then click [Next]. (8) Select [This program path]. Specify the following path and click [Next]. C:\ProgramFiles(x86)\Canon Electronics\SharedFiles\DriverNetworkMonitor.exe (9) Set each item as follows, and then click [Next]. Protocol type: UDP Local port: Specific Ports Port Number: 5353 Remote port: Specific Ports Port Number: 5353 (10) Select [Any IP address] for both local IP address and remote IP address, and then click [Next]. (11) Select [Allow the connection], and then click [Next]. (12) Specify when the rule is applied, and then click [Next]. (13) Enter a name, and then click [Finish].
<p>The cause is the security software settings.</p>	<p>Connection may not be possible due to security software settings. For details, please contact your network administrator.</p>
<p>A heavy load is placed on the network.</p>	<p>Check the status of network traffic. When a heavy load is placed on the network, processing takes time and timeouts may occur. Wait for awhile and then reconnect. If the situation does not improve please contact your network administrator.</p>

■ **Automatic connection to the network is not possible.**

<Wired LAN connection>

<p>The IP address is not set properly.</p>	<p>If your network environment supports DHCP, consult your network administrator. If your network environment does not support DHCP, configure the IP address manually.</p>
--	---

■ You cannot log in as an administrator.

You forgot your administrator password.	Resetting the scanner to the factory default state (See p. 76) resets the administrator password to the factory default state.
---	--

Problems with Scanning

Problems with feeding

■ Feeding does not start.

The document is not fully inserted.	Insert the document all the way in. (See p. 24)
The scanner has not been able to communicate with the computer.	(1) Confirm that the USB cable or LAN cable is properly connected. (2) If the situation does not improve, unplug and plug back in the USB cable or LAN cable. (3) If the situation still does not improve, restart the scanner and the computer.
The document is not placed in the document feed tray properly.	If the leading edge of the document is curled, straighten it before placing the document. For thin documents, push them in until the leading edge hits the stopper.

<USB connection>

Windows lock errors occur frequently.	Windows Windows may have failed in controlling USB communication. In Canon imageFORMULA Driver Setting Tool, select [Do not use USB connection control of operating system].
---------------------------------------	--

<Wired LAN connection>

The correct scanner is not operated or selected.	Confirm that the correct scanner is selected with the software used and that the correct scanner is operated.
--	---

■ Documents feed askew (scanned images are slanted).

There is a gap between the document and the document guides.	Align the document guides to fit the documents as closely as possible, and load the documents so that they feed straightly.
The document feed extension support is not opened.	Open the document feed extension support and place the document.
The rollers are dirty.	Clean the rollers. (See p. 113)

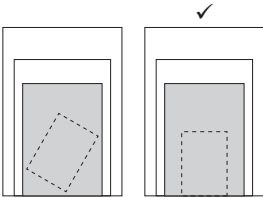
The rollers are worn out.	Replace the rollers. (See p. 117, p. 118)
The inside of the scanner is dirty.	If there are foreign objects such as trash inside the scanner, the documents will not be correctly transported. Clean the inside of the scanner.
If the document stack contains mixed sizes, the leading edges of the document are not aligned.	Align the leading edges of the document. 

<Scanning with CaptureOnTouch>

The function to automatically straighten skewed images is not enabled.	For [Automatically straightens skewed images] in [Select document], set [Straightens with angle of fed documents] or [Straightens with angle contents of fed documents].
--	--

<Scanning with CaptureOnTouch Lite Web/Scanning by selecting a job in the scanner>

The function to automatically straighten skewed images is not enabled.	Set [Page Size] to [Auto]. If it is not set to [Auto], the function to automatically straighten skewed images is disabled.
--	--

<Scanning with other applications>

The function to automatically straighten skewed images is not enabled.	<p>Windows</p> <p>Turn on [Automatically straightens skewed] on the [Basic] tab on the scanner driver settings screen.</p> <p>Mac</p> <p>Turn on [Deskew] on the scanner driver settings screen.</p>
--	--

■ Documents jam.

The rollers are not mounted properly.	Mount the rollers properly. (See p. 117, p. 118)
The rollers are dirty.	Clean the rollers. (See p. 113)
Document pages stick together.	Proper scanning may not be possible when document pages stick together due to static electricity. Fan the documents before you load them.

If the problem is not solved even after the above measures	Set the feed selection lever to Bypass mode, and manually feed the scanner one page at a time.
--	--

■ **A document double feed occurs.**

The rollers are not mounted properly.	Mount the rollers properly. (See p. 117, p. 118)
The rollers are dirty.	Clean the rollers. (See p. 113)
Document pages stick together.	Proper scanning may not be possible when document pages stick together due to static electricity. Fan the documents before you load them.
If the problem is not solved even after the above measures	Set the feed selection lever to Bypass mode, and manually feed the scanner one page at a time.
The leading edges of the document are not aligned.	If the leading edges of the document are not aligned, a double feed may occur. Align the leading edges of the document.

■ **A plastic card, envelope, or booklet is detected erroneously as a double feed.**

<Scanning with CaptureOnTouch>

Ultrasonic double feed detection is enabled.	<p>Windows</p> <ul style="list-style-type: none"> • Check [Detect by Ultrasonic] on the [Error Detection] tab in the advanced settings dialog box. • Check [Rapid recovery system] on the [Others] tab in the advanced settings dialog box. <p>Mac</p> <ul style="list-style-type: none"> • Check [Double Feed Detection] in the advanced settings dialog box or set the detection method to [Detect by Length]. • Check [Rapid recovery system] in the advanced settings dialog box.
--	---

<Scanning with CaptureOnTouch Lite Web/Scanning by selecting a job in the scanner>

Ultrasonic double feed detection is enabled.	Temporarily disable double feed detection on the scanner Settings Menu. (See p. 81)
--	---

<Scanning with a Mopria-compatible device>

Ultrasonic double feed detection is enabled.	Refer to the Help of applications.
--	------------------------------------

<Scanning with other applications>

Ultrasonic double feed detection is enabled.	<p>Windows</p> <ul style="list-style-type: none">• Check [Detect by Ultrasonic] on the [Error Detection] tab on the scanner driver settings screen.• Check [Rapid recovery system] on the [Others] tab on the scanner driver settings screen. <p>Mac</p> <ul style="list-style-type: none">• Check [Double Feed Detection] on the scanner driver settings screen or set the detection method to [Detect by Length].• Check [Rapid recovery system] in the [More] dialog box on the scanner driver settings screen. <p>Alternatively, temporarily disable the double feed detection function on the scanner Settings Menu. (See p. 81)</p>
--	---

Problems with the software/scanner driver

■ Pages are missing.

A document double feed occurs.	Refer to “A document double feed occurs.” (See p. 126).
--------------------------------	---

<Scanning with CaptureOnTouch>

The skip blank page function is enabled.	If [Scanning Side] is set to [Skip Blank Page] in the advanced settings dialog box, a document with few black portions may be unintentionally deleted (skipped). Decrease the value under [Set the likelihood of skipping blank page]. For details, refer to the Help of the scanner driver. Alternatively, set [Scanning Side] to an option other than [Skip Blank Page] in the advanced settings dialog box.
--	--

<Scanning with CaptureOnTouch Lite Web/Scanning by selecting a job in the scanner>

The skip blank page function is enabled.	If the [Scanning side] of the CaptureOnTouch Lite Web function is set to [Skip blank page], a document with few black portions may be unintentionally deleted (skipped). Set [Scanning side] to an option other than [Skip blank page]. If the job has the Skip Blank Page setting, change the job setting. (See p. 43, p. 107)
--	--

<Scanning with a Mopria-compatible device>

A document double feed occurs.	Fan the documents and place them again.
--------------------------------	---

<Scanning with other applications>

The skip blank page function is enabled.	When [Scanning Side] is set to [Skip Blank Page] on the scanner driver settings screen, a document with few black portions may be unintentionally deleted (skipped). Decrease the value under [Set the likelihood of skipping blank page]. For details, refer to the Help of the scanner driver. Alternatively, set [Scanning Side] to an option other than [Skip Blank Page] on the scanner driver settings screen.
--	---

■ All of the placed documents have been scanned, but the scanned image does not appear on the application.

<Scanning with CaptureOnTouch>

The skip blank page function is enabled.	If [Scanning Side] is set to [Skip Blank Page] in the advanced settings dialog box, a document with few black portions may be unintentionally deleted (skipped). Decrease the value under [Set the likelihood of skipping blank page]. For details, refer to the Help of the scanner driver. Alternatively, set [Scanning Side] to an option other than [Skip Blank Page] in the advanced settings dialog box.
The separation paper for batch separation is discarded.	If [Separation paper] is set to [Discard page] in the [Batch separation setting] of CaptureOnTouch, set it to [Include in the current document] or [Include in a new document].

<Scanning with CaptureOnTouch Lite Web/Scanning by selecting a job in the scanner>

The skip blank page function is enabled.	If the [Scanning side] of the CaptureOnTouch Lite Web function is set to [Skip blank page], a document with few black portions may be unintentionally deleted (skipped). Set [Scanning side] to an option other than [Skip blank page]. If the job has the Skip Blank Page setting, change the job setting. (See p. 43, p. 107)
--	--

<Scanning with a Mopria-compatible device>

The network connection was lost during scanning.	Confirm that the network connection was not lost during scanning, and try scanning again.
--	---

<Scanning with other applications>

The scanner is waiting for additional documents.	When [Feeding Option] is set to [Panel-Feeding] or [Automatic Feeding] on the scanner driver settings screen, the scanned image may not be displayed until the Stop key on the scanner is pressed to end the scanning operation depending on the application.
--	---

The skip blank page function is enabled.	When [Scanning Side] is set to [Skip Blank Page] on the scanner driver settings screen, and all scanned documents are determined to be blank, no scanned image is output. Decrease the value under [Set the likelihood of skipping blank page] or set [Scanning Side] to an option other than [Skip Blank Page].
--	--

■ **Memory becomes insufficient and scanning stops.**

<Scanning with CaptureOnTouch>

The computer memory is insufficient.	<p>If you configure scanning conditions that use a large amount of the computer's memory, scanning may stop because of insufficient memory. Although this depends on the computer's memory size, the possibility of insufficient memory increases if any of the following scanning conditions overlap.</p> <ul style="list-style-type: none"> • [Color mode] is set to [Color] • A large page size (e.g. Legal) is specified as the [Page Size]. Alternatively, the page size is set to [Scanner's Maximum]. • A high resolution (600dpi etc.) is specified for [Dots per inch]. <p>If an error message appears due to insufficient memory while scanning is in progress, exit the application, change the scanning conditions (e.g. reduce the resolution or page size) and then try scanning again. In addition, the amount of memory used can be contained by turning off [Moire Reduction] and [Prevent Bleed Through / Remove Background] if they are set to on.</p>
--------------------------------------	--

<Scanning with CaptureOnTouch Lite Web/Scanning by selecting a job in the scanner>

The memory is insufficient due to scanned image data.	Reduce the number of documents scanned at once and scan again. Alternatively, decrease the resolution and scan again.
---	---

<Scanning with a Mopria-compatible device>

The memory is insufficient due to scanned image data.	Reduce the number of documents scanned at once and scan again. Alternatively, decrease the resolution and scan again.
---	---

<Scanning with other applications>

The memory is insufficient due to scanned image data.	Review the settings of the scanner driver or refer to the Help of applications.
---	---

■ Documents are not scanned according to the settings configured in the scanner driver.

<Scanning with CaptureOnTouch>

<p>The CaptureOnTouch settings take precedence.</p>	<p>Refer to “Common Problems and Solutions” in the Help of CaptureOnTouch. When you scan using Select document panel registered with CaptureOnTouch, the CaptureOnTouch settings have priority over the scanner driver settings. Edit settings in the Select document panel, or create a new Select document panel using the desired scanning conditions.</p>
---	---

<Scanning with a Mopria-compatible device>

Contact the support of the Mopria-compatible application.

<Scanning with other applications>

<p>There are settings that take precedence over the scanner driver settings.</p>	<p>Windows</p> <p>If [Prevent changing default settings] is enabled in the Canon imageFORMULA Driver Setting Tool, scanning is always performed at the default values. Confirm the settings of the Driver Setting Tool.</p> <p>If the setting for temporarily disabling double feed deflection or the setting for temporarily entering passport mode is made on the scanner Settings Menu, this setting takes precedence. Check the settings on the scanner Settings Menu. (See p. 81, p. 81)</p> <p>Depending on the application, scanning may be performed by changing the settings made in the scanner driver. Refer to the Help of applications.</p>
--	---

■ Scan is too slow.

<p>There is a conflict of resources between other application software and the computer.</p>	<p>If the system memory is insufficient due to other application software or if the access to storage increases, the scan speed may slow down. Close such software before scanning.</p>
<p>Antivirus software is monitoring.</p>	<p>If access to temporary files or memory is being monitored by antivirus software, the scan speed may slow down. In this case, either quit the antivirus software or remove scanning from the monitoring targets.</p>
<p>There is not enough free space on the computer's storage.</p>	<p>If there is not enough free space in the computer's storage, the scanner may be unable to create the necessary temporary files for scanned data. Organize the data on the storage and secure free space.</p>
<p>Scanning is performed in long document mode.</p>	<p>If “Scanning in long document mode” is displayed on the display during scanning, disable long document mode. (See p. 53)</p>

<USB connection>

The computer's USB port is not compliant with high-speed standards.	Scanning is slow, if the computer's USB port is not compliant with high-speed standards such as USB2.0 and USB3.2 Gen1x1.
The USB cable is not compliant with USB3.2 Gen1x1.	If using a common USB cable that is not USB3.2 Gen1x1 compliant, replace the cable with the supplied compliant cable.
The USB hub is not compliant with USB3.2 Gen1x1.	When the scanner is connected to the computer via a USB hub that is not USB3.2 Gen1x1 compliant, remove the hub and connect the scanner directly to the computer.

<Wired LAN connection>

A heavy load is placed on the network.	Check the status of network traffic. When a heavy load is placed on the network, processing may take time. Wait for awhile and then reconnect. If the situation does not improve please contact your network administrator.
Slow cables or communication devices are used.	Upgrading the LAN cables, computer's LAN port, or communication devices such as hubs or routers to ones that can communicate at higher speeds may improve the speed.

<Scanning with CaptureOnTouch>

Refer to "Common Problems and Solutions" in the Help of CaptureOnTouch.

<Scanning with CaptureOnTouch Lite Web/Scanning by selecting a job in the scanner>

A heavy load is placed on the network.	Check the status of network traffic. When a heavy load is placed on the network, processing may take time. Wait for awhile and then reconnect. If the situation does not improve please contact your network administrator.
--	---

<Scanning with other applications>

Refer to the Help of applications.

■ The scanned image files cannot be opened in an application.

The application does not support compressed TIFF files.	Depending on the application, if TIFF files are compressed, they cannot be opened. Select "None" as the image file compression format before scanning.
---	--

<Scanning with CaptureOnTouch>

The application does not support compressed TIFF files.	Refer to "TIFF file setting" in the Help of CaptureOnTouch.
---	---

<Scanning with CaptureOnTouch Lite Web/Scanning by selecting a job in the scanner>

ZIP files cannot be unzipped.	The CaptureOnTouch Lite Web function saves scanned images as a ZIP file on the device. To retrieve the images, unzip the ZIP file.
The application does not support multi-page TIFF files.	Scanned images saved as multi-page TIFF files can be opened only by programs that support this file format.

<Scanning with a Mopria-compatible device>

Contact the support of the Mopria-compatible application.

<Scanning with other applications>

The application does not support multi-page TIFF files.	Scanned images saved as multi-page TIFF files can be opened only by programs that support this file format.
---	---

■ **Multiple pages of scanned images cannot be saved to a single file.**

<Scanning with CaptureOnTouch>

An attempt is made to save multiple pages of scanned images to a single file in a format that does not enable such saving.	Refer to “Common Problems and Solutions” in the Help of CaptureOnTouch. Depending on the file format, multiple scanned image pages cannot be saved as a single file with CaptureOnTouch. Format that enables such saving: TIFF, PDF Format that does not enable such saving: JPEG, PNG, BMP
--	--

<Scanning with CaptureOnTouch Lite Web/Scanning by selecting a job in the scanner>

An attempt is made to save multiple pages of scanned images to a single file in a format that does not enable such saving.	Depending on the file format, multiple scanned image pages cannot be saved as a single file. Format that enables such saving: TIFF, PDF Format that does not enable such saving: JPEG, PNG, BMP
--	---

<Scanning with a Mopria-compatible device>

Contact the support of the Mopria-compatible application.

<Scanning with other applications>

Refer to the Help of applications.

■ There is a display glitch on the UI screen of CaptureOnTouch.

<Scanning with CaptureOnTouch>

There are too many Scan mode panels, Select output panels, or Scanning Shortcut panels.	Depending on the computer that you are using, a display glitch may occur on the UI screen when there are too many Scan mode panels, Select output panels, or Scanning Shortcut panels. Delete any panel that you will not use.
---	--

Problems with scanning quality

■ The size detection and deskew functions fail.

<Scanning with CaptureOnTouch>

The edges of the document are not straight.	Documents with jagged edges from perforations, edges cut diagonally, or curved edges can cause failures in size detection and deskew functions. Set the [Page Size] in [Select document] to a standard size such as A4 or Letter. Alternatively, turn [Automatically straightens skewed images] OFF.
The edges of the document are black.	Documents with black edges can cause failures in size detection and deskew functions, or edges of the document may be cut off. Set the [Page Size] in [Select document] to a standard size such as A4 or Letter. Alternatively, turn [Automatically straightens skewed images] OFF.
You are scanning a document with black edges without inserting it in a carrier sheet while [Document type] is set to [Carrier sheet] in the advanced settings dialog box.	If [Document type] is set to [Carrier sheet] in the advanced settings dialog box, placing a document with black edges without inserting it in a carrier sheet and scanning it may result in failures in size detection and deskew functions. Set [Page Size] to a standard size such as A4 or Letter or to a custom page size in the advanced settings dialog box. Alternatively, uncheck [Automatically straightens skewed] (Windows)/[Deskew] (macOS). Alternatively, set [Document type] to [Plain paper].

<Scanning with CaptureOnTouch Lite Web/Scanning by selecting a job in the scanner>

The edges of the document are not straight.	Documents with jagged edges from perforations, edges cut diagonally, or curved edges can cause failures in size detection and deskew functions. Select a standard size other than [Auto] for [Page Size].
The edges of the document are black.	Documents with jagged edges from perforations, edges cut diagonally, or curved edges can cause failures in size detection and deskew functions. Select a standard size other than [Auto] for [Page Size].

<Scanning with a Mopria-compatible device>

Contact the support of the Mopria-compatible application.

<Scanning with other applications>

The edges of the document are not straight.	Documents with jagged edges from perforations, edges cut diagonally, or curved edges can cause failures in size detection and deskew functions. Set [Page Size] to a standard size such as A4 or Letter or to a custom page size on the scanner driver settings screen. Alternatively, uncheck [Automatically straightens skewed] (Windows)/[Deskew] (macOS).
The edges of the document are black.	Documents with black edges can cause failures in size detection and deskew functions, or edges of the document may be cut off. Set [Page Size] to a standard size such as A4 or Letter or to a custom page size on the scanner driver settings screen. Alternatively, uncheck [Automatically straightens skewed] (Windows)/[Deskew] (macOS).
You are scanning a document with black edges without inserting it in a carrier sheet while the [Document type] for the scanner driver is set to [Carrier sheet].	When [Document type] is set to [Carrier sheet] on the scanner driver settings screen and you scan a document with black edges without inserting it in a carrier sheet, the size detection and deskew functions may fail. Set [Page Size] to a standard size such as A4 or Letter or to a custom page size on the scanner driver settings screen. Alternatively, uncheck [Automatically straightens skewed] (Windows)/[Deskew] (macOS) or set [Document type] to [Plain paper].

■ If white lines or streaks appear in scanned images.

The scanner glass and the rollers are dirty.	Clean both sides of the scanner glass, and the rollers. If a sticky substance such as glue or correction fluid is found, carefully wipe with just enough pressure to clean the area where the lines appear. If the problem cannot be solved by cleaning, the internal glass may be scratched. Contact your local authorized Canon dealer or service representative.
--	---

■ The scanned characters and images are blurred.

<Scanning with CaptureOnTouch>

The compression rate is set high.	From the JPEG and PDF settings, select a setting for prioritizing image quality.
The scanning resolution is low.	Increase [Dots per inch].

<Scanning with CaptureOnTouch Lite Web/Scanning by selecting a job in the scanner>

The image quality setting is low.	Increase [Quality]. (See p. 36, p. 111)
The scanning resolution is low.	Increase [Dots per inch]. (See p. 35, p. 108)

Moire patterns are occurring.	Changing the [Dots per inch] setting can sometimes improve moire patterns. Change [Dots per inch] to another value. (See p. 35, p. 108)
-------------------------------	---

<Scanning with a Mopria-compatible device>

The scanning resolution is low.	Increase the resolution.
---------------------------------	--------------------------

<Scanning with other applications>

The noise reduction function is strong, or the edge emphasis function is soft.	Uncheck [Noise reduction] or reduce the reduction level on the scanner driver settings screen. Alternatively, set [Edge emphasis] towards [Sharp]. Alternatively, increase [Dots per inch].
--	---

■ The scanned image has uneven shades.

<Scanning with CaptureOnTouch>

Dot printing (halftone) results in moire patterns (grid-shaped shading).	See “Moire patterns (grid-shaped shading) appear.” (p. 136)
Unevenness in paper or printing appears in the scanned image.	Enable [Noise reduction] or increase the reduction level in the advanced settings dialog box. Alternatively, enable [Background smoothing].

<Scanning with other applications>

Dot printing (halftone) results in moire patterns (grid-shaped shading).	See “Moire patterns (grid-shaped shading) appear.” (p. 136)
Unevenness in paper or printing appears in the scanned image.	Enable [Noise reduction] or increase the reduction level on the scanner driver settings screen. Alternatively, enable [Background smoothing].

■ The back of the document is reflected.

<Scanning with CaptureOnTouch>

Enable [Prevent Bleed Through / Remove Background] in the advanced settings dialog box. Alternatively, change the settings for [Brightness] or [Contrast].

When [Active Threshold], [Advanced Text Enhancement] (Windows only), or [Advanced Text Enhancement II] is selected for [Color mode] in the advanced settings dialog box, faint bleed-through might be emphasized. In such cases, change the color mode.

<Scanning with a Mopria-compatible device>

Refer to the Help of applications.

<Scanning with other applications>

Enable [Prevent Bleed Through / Remove Background] on the scanner driver settings screen. Alternatively, change the settings for [Brightness] or [Contrast].

When [Active Threshold], [Advanced Text Enhancement] (Windows only), or [Advanced Text Enhancement II] is selected for [Color mode] on the scanner driver settings screen, faint bleed-through might be emphasized. In this case, change the color mode.

■ Moire patterns (grid-shaped shading) appear.**<Scanning with CaptureOnTouch>**

Select either [High Speed Moire Reduction] or [High Quality Moire Reduction] for [Moire Reduction] in the advanced settings dialog box. Changing the resolution setting can sometimes improve moire patterns. Change the resolution to another value.

<Scanning with CaptureOnTouch Lite Web/Scanning by selecting a job in the scanner>

Scan with another method.

<Scanning with a Mopria-compatible device>

Refer to the Help of applications.

<Scanning with other applications>

Select either [High Speed Moire Reduction] or [High Quality Moire Reduction] for [Moire Reduction] on the scanner driver settings screen. Changing the resolution setting can sometimes improve moire patterns. Change the resolution to another value.

■ Characters are not recognized properly.**<Scanning with CaptureOnTouch>**

The characters on the document are faint, or the color of the characters is close to that of the background.	Select [Active Threshold], [Advanced Text Enhancement] (Windows only), or [Advanced Text Enhancement II] for [Color mode] in the advanced settings dialog box. Alternatively, to make the characters stand out, change the settings for brightness and contrast.
There are ruled lines near the characters.	Change the [Color drop-out] setting in the advanced settings dialog box to drop out the ruled lines.
The line of characters is thin.	Change [Character Emphasis] in the advanced settings dialog box to make it thicker.
The line of characters is blurry.	Turn off [Noise reduction] in the advanced settings dialog box or reduce the reduction level. Alternatively, set [Edge emphasis] towards [Sharp].
The characters are too large or too small.	If the characters are too large, reduce [Dots per inch]. If they are too small, increase [Dots per inch].

<Scanning with CaptureOnTouch Lite Web/Scanning by selecting a job in the scanner>

Scan with another method.

<Scanning with a Mopria-compatible device>

Refer to the Help of applications.

<Scanning with other applications>

Refer to the Help of applications.

■ The barcode or QR code is not recognized properly.

The printing of the barcode or QR code is faint.	Windows Enable [Set the barcode detecting image to contrast enhanced] with the Canon imageFORMULA Driver Setting Tool.
The resolution of the scanned image is low, or the printing of the barcode or QR code is small.	Windows Enable [Set the barcode detecting image to 300 dpi or higher] with the Canon imageFORMULA Driver Setting Tool.

Problems with the Web Menu

■ The Web Menu cannot be accessed.

The IP address of the scanner is not set.	Confirm that the IP address and DHCP are enabled/disabled properly. (See p. 84)
TLS1.2 is disabled in the web browser.	Change the settings in the web browser to enable TLS 1.2. Note that this scanner does not support TLS 1.3.

<p>The web browser does not have a proxy server setting for local addresses.</p>	<p>Set it so that a proxy server is not used for connections to local addresses.</p> <p>Windows</p> <ol style="list-style-type: none"> (1) Click the [Start] button, and then click [Windows System] – [Control Panel]. (2) Click [Network and Internet]. (3) Click [Internet Options]. (4) Click [LAN settings] on the [Connections] tab. (5) For [Proxy server], make a setting for not using a proxy server for connections to local addresses. <p>Mac</p> <ol style="list-style-type: none"> (1) Select [System Preferences] from the Apple menu. (2) Click [Network]. (3) Click [Advanced]. (4) Click [Proxies]. (5) For [Bypass proxy settings for these Hosts & Domains], register local addresses.
--	--

■ **When a connection is made with https communication, “The certificate has expired” is displayed.**

<p>The SSL server certificate has expired.</p>	<p>Install a certificate with the appropriate expiration date. (See p. 99) If this message is displayed before the certificate’s expiration date, check that the scanner’s time is correctly set. (See p. 69)</p>
--	--

■ **When a connection is made with https communication, “The name of the security certificate does not match” is displayed.**

<p>The common names of the certificate and the scanner are different.</p>	<ul style="list-style-type: none"> • This occurs when: The IP address of the scanner in the common name when a self-signed certificate is created or updated or when a CSR is created is different from the IP address entered into the web browser when the Web Menu is started. • This occurs when a different IP address is input in the web browser when launching Web Menu. <p>If you are using a self-signed certificate, update and install the certificate. (See p. 99) If you are using a CA-signed certificate, acquire a certificate for the desired scanner and install it. (See p. 99)</p>
---	--

■ **When a connection is made with https communication, “The connection is not private” is displayed.**

<p>An attempt is made to display the Web Menu when there is no appropriate SSL server certificate.</p>	<p>Such a warning screen appears when an attempt is made to use https communication with no appropriate SSL server certificate installed in the scanner.</p> <p>For general users Contact your administrator. Alternatively, display the Web Menu from the QR code on the operation panel of the scanner. (See p. 34) Note that in this case, the connection will be an http connection.</p> <p>For administrators An appropriate SSL server certificate is not installed in the Web Menu. Refer to “Installing an SSL Server Certificate (Web Menu Only)” (See p. 99) to install it.</p>
--	---

■ **You cannot log in as an administrator.**

<p>You forgot your administrator password.</p>	<p>Resetting the scanner to the factory default state (See p. 76) resets the administrator password to the factory default state.</p>
--	---

Frequently Asked Questions

This section provides frequently asked questions and answers.

Questions about CaptureOnTouch

Here are questions and answers about CaptureOnTouch.

For details, refer to the Help of CaptureOnTouch.

Problem 1. Where are scanned images saved? Can the save destination be changed?

Solutions 1. Both Standard Scanning and Scanning Shortcut save the output to the destination set in the [Select output] panel. All destination locations can be changed to other folders.

Problem 2. How are the scan settings configured?

Solutions 2. By clicking the Edit button in the Select document panel, you can edit the scan settings when the Select document edit screen dialog box opens.

Problem 3. How do I save multiple pages in one file, or save one file per page?

Solutions 3. When scanned images are saved in BMP, JPEG or PNG format, each image is always saved in a separate file. When scanned images are saved in PDF or TIFF format, you can specify multi- or single-page files. Refer also to “Multiple pages of scanned images cannot be saved to a single file.” in “When in Trouble”.

Problem 4. Can I copy or back up scanner setting configurations?

Solutions 4. The setting configurations can be backed up and restored using [Back Up/Restore] on the [Basic settings] tab on the [Environmental settings] dialog box.

Problem 5. What rules apply to scanned image file names?

Solutions 5. For both Standard Scanning and Scanning Shortcut, the file names of scanned images are set based on the settings in the [Select output] panel. This screen opens when you click the Edit button in the [Select output] panel.

Click the [Detail Settings] button on this screen. You can set the file names of scanned images by setting all or some of the three items shown below.

Setting	Description
File name	Any specified text string to be included in the file name.
Add date and time	Appends the date and time to file names. Select the date format from the list box. YYYY = year, MM = month, and DD = day of month. The time is appended after the date.
Add counter to file name	Append serial numbers in the order of scanned image saving. Specify the number of digits and starting number.

A sample file name is displayed as the [File name] in the [File name settings] dialog box.

Problem 6. How do I print scanned data?

Solutions 6. For both Standard Scanning and Scanning Shortcut, select [Print] in the [Select output] panel. To use this function, you need to install a plug-in. The plug-in can be installed by selecting its checkbox when installing CaptureOnTouch.

Problem 7. I want to save to other folders

Solutions 7. In CaptureOnTouch, destinations other than [Save to folder] are provided as a plug-in. By installing the plug-in, the scanned image can be printed, attached in an e-mail, or shared using various cloud services. The plug-in can be installed by selecting its checkbox when installing CaptureOnTouch. The available output destinations vary depending on the installed plug-in.

Problem 8. How can I attach scanned data to an e-mail (or send it as e-mail)?

Solutions 8. For both Standard Scanning and Scanning Shortcut, select [Attach to E-mail] in the [Select output] panel. To use this function, you need to install a plug-in. The plug-in can be installed by selecting its checkbox when installing CaptureOnTouch.

Problem 2. How do I combine both sides of a document and output into one image?

Solutions 2. Set [Scanning Side] to [Folio] on the scanner driver setting screen, then scan. To change the position and direction of combination, change the [Folio] settings.

Problem 3. How can I skip blank pages, and scan only non-blank pages?

Solutions 3. Set [Scanning Side] to [Skip Blank Page] on the scanner driver setting screen, then scan.

Problem 4. How do I scan cards?

Solutions 4. Set a card in landscape orientation in the scanner. If the card is embossed, set the feed selection lever to Bypass mode. Set [Page Size] to the same size as the card or to [Match original size] on the scanner driver settings screen.

Windows

Disable [Detect by Ultrasonic] on the [Error Detection] tab on the scanner driver settings screen, then scan.

Mac

Uncheck [Double Feed Detection] on the scanner driver settings screen or set the detection method to [Detect by Length], then scan.

Problem 5. How do I load and scan documents with mixed sizes?

Solutions 5. Pull out the document eject tray at an angle. Set [Page Size] to [Match original size] on the scanner driver setting screen, then scan.

Problem 6. How do I scan a document whose size is not found in the page size list?

Solutions 6. Set [Page Size] to [Match original size] on the scanner driver setting screen, then scan. Alternatively, register the same size as that of the document to scan in [Page Size], then scan.

Questions about the scanner driver

Here are questions and answers about the scanner driver. For details, refer to the Help of the scanner driver.

Problem 1. How do I scan a document larger than A4 (Letter)?

Solutions 1. (1) Set the feed selection lever to Bypass mode. (2) Crease the document firmly down its center to fold the document in half. Fold the document so that its edges are neatly aligned. (3) Place the document in the scanner with the folded edge facing right and the top edge facing downward. (4) Set [Page Size] to half the size of the paper you are actually going to scan on the scanner driver settings screen. Select [Folio] for [Scanning Side], then scan.

Problem 7. How do I scan cards?

Solutions 7. Set the cards vertically in the scanner. Set [Page Size] to the same size as that of the card or to [Match original size] on the scanner driver settings screen. Set [Document Orientation] according to the print orientation of the card, and scan.

Problem 8. How do I scan a document that includes both photos and characters?

Solutions 8. Select [Document with photo] for [User Preference] (Windows)/[Favorite Settings] (macOS) on the scanner driver settings screen or select [Document with photo] for [Document type], then scan.

Problem 9. How do I scan passports?

Solutions 9. (1) Set the feed selection lever to Bypass mode.
(2) Place a passport in the carrier sheet (for passport), and load the sheet with the sealed end of the carrier sheet as the leading edge and the page you want to scan facing down.
(3) Select [Passport] for [User Preference] (Windows)/[Favorite Settings] (macOS) on the scanner driver settings screen or select [Passport] for [Document type], then scan.

Depending on the condition of the carrier sheet or passport, a paper jam may occur or the scanner's image correction may not function properly.

Configure the settings as shown below.

- (1) Set [Page Size] to a larger paper size (A4, for example) on the scanner driver settings screen, and then scan again.
- (2) Set [Dots per inch] to 300 dpi or less on the scanner driver settings screen.
- (3) Clean the roller.

Questions about the scanner**Problem 1. I want to initialize the settings.**

Solutions 1. For the Web Menu, click [Administrator settings] – [System management] – [Initialize].
For the scanner Settings Menu, initialize the settings with [Device Configuration] – [Initialize].
Initialization does not reset the firmware version to the factory default state.

Problem 2. I want to reset to the factory default settings.

Solutions 2. Resetting the scanner to the factory default state not only initializes (See p. 76) the settings but also resets the firmware version to the factory default state.

Clearing a Paper Jam

When paper jams are detected during scanning, the following error codes are displayed in the display and scanning is interrupted.

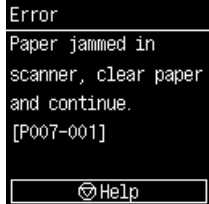

When a paper jam or double feed occurs during scanning, use the following procedures to clear them.

CAUTION

Be careful when removing jammed paper. Take care not to cut your hand on the edges of the paper.

-
- 1 Remove any documents that have been left in the feed Tray.**

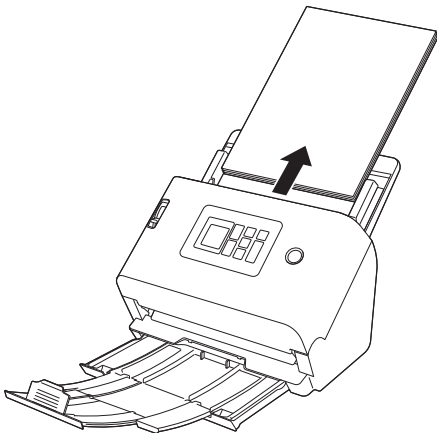

-
- 2 Pull the OPEN lever and pull open the front unit toward you.**

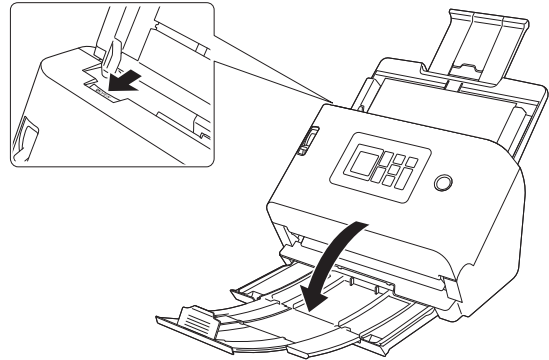

-
- 3 Remove the jammed document.**

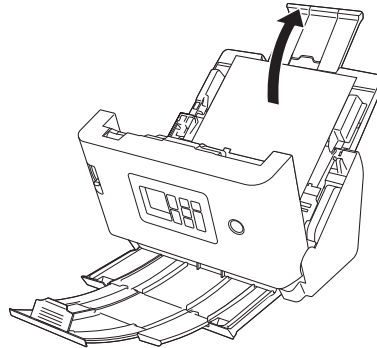

! **IMPORTANT**

Make sure to pull the document out carefully, without applying too much force. If the jammed paper tears while you are pulling it out, make sure to remove any remaining pieces from inside the scanner.

- 4** **Close the front unit by gently pushing it up on both sides until it clicks into place. Make sure that the front unit is completely closed by pushing until you hear a click.**

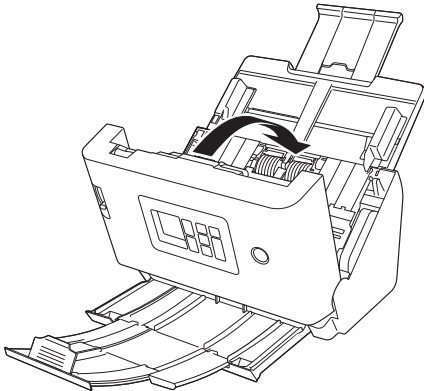

After removing the jammed paper, check to see if the last page was scanned correctly, and then continue scanning.

💡 Hint

When the [Rapid recovery system] check box is enabled in the scanner driver settings screen, you can resume a scanning operation even if it is interrupted by a paper jam by removing the document and resuming from the document that was being fed when the interruption occurred.

As the image of the document that was being fed at the time of the interruption may not be saved in such cases, be sure to verify the last scanned image before resuming the operation.

Error Message

If one of the following messages appears on the display, then an error has occurred on the scanner. Handle the error according to the countermeasure procedure.

Error messages	Symptom	Countermeasure
The Scanner cover is open. [C0XX-XXX]	Front unit is open.	Close the front unit.
Paper jammed in scanner, clear paper and continue. [P0XX-XXX]	Paper jammed while scanning.	Open the front unit, and then remove the jammed document. Depending on the document, paper jams may be likely to occur. If the error is repeated, change the scan setting to Passport mode or Bypass mode.
A double paper-feed has occurred. Please check the document and the scanned image on the display and scan the document again. [D0XX-XXX]	Paper double fed while scanning.	Open the front unit and then remove the document that caused a double feed. Please check the scanned image on the display and scan the document again. If the error is repeated, fan the document.
This scanner is not connected to your device via USB. Please check the USB connection.	An attempt is made to scan when the scanner is not connected via USB.	Confirm that the scanner is properly connected to the computer via USB. If the problem cannot be solved, refer also to “When in Trouble” (See p. 121) .
Scanner is not connected to the network. Make sure the scanner is properly connected to the wired LAN.	An attempt is made to scan via a network when the scanner is not connected to the network.	Confirm that the scanner is connected to the network. If the problem cannot be solved, refer also to “When in Trouble” (See p. 121) .
This function cannot be used because it is not connected to the network. Please check the connection status.	An attempt is made to use the CaptureOnTouch Lite Web function when the scanner is not connected to the network.	To use the CaptureOnTouch Lite Web function, the scanner must be connected to the network. Confirm the network settings.
Could not confirm storage location. Check if path, user name, or password are wrong?	Sending the scanned image failed.	Set the destination, user name, and password properly.
Could not send the files because authentication failed. Check the authentication settings of destination server.	The authentication settings for the destination are incorrect.	Confirm that the destination is correct.
File access error occurred. Check write protect or disk full.	There is not enough free space at the destination.	Confirm the capacity of the destination and change the destination if necessary.

Error messages	Symptom	Countermeasure
COTAdmin cannot be used because it is not connected to the network. [1000]	COT Admin was enabled when the scanner was not connected to the network.	To use COT Admin, a network connection is required. Confirm that the scanner is properly connected to the network. If you do not use COT Admin, disable COT Admin. (See p. 103)
Failed to connect to the COT Admin server. Contact your administrator. [XXXX]	Connecting to the COT Admin server failed.	To use COT Admin, you must set the COT Admin server. Contact the person in charge of the system to confirm that the COT Admin server is set properly. If you do not use COT Admin, disable COT Admin. (See p. 103)
It is recommended to replace the rollers to keep the scanner in good condition. Be sure to reset the counter after replacement.	The number of pages scanned exceeded the roller feed count.	Replace the rollers. (See p. 117, p. 118)
The scanner's system date is incorrect. If you continue to operate as it is, you will not be able to communicate with the network. Please set the system date again.	The scanner's internal clock was reset.	If the scanner's power plug is left unplugged for about two days, the scanner's internal clock will be reset. Set the date and time again. If this error is displayed while the NTP function is enabled, the scanner is not synchronizing correctly with the NTP server. Check the network connection status.
The system date outside the certificate expiration date was set. If the entered value is wrong, please set it again. If the value is correct, please initialize the certificate.	The time on the scanner is set beyond the expiration date of the server certificate.	Set the time for the scanner properly. Alternatively, confirm the expiration date of the server certificate registered in the scanner and change it to a certificate with an appropriate expiration date. To change the certificate, you need the administrator password.
A hardware error was detected. [E0XX-XXX]	There is an internal scanner error.	Turn the power off and then on again. If the error appears even after you turn the power off and then on again, make a note of the error message, and then contact the person in charge of the system.

Error messages	Symptom	Countermeasure
A hardware error was detected. [S0XX-XXX]	There is an internal scanner error.	Turn the power off and then on again. If the error appears even after you turn the power off and then on again, make a note of the error message, and then contact the person in charge of the system. If you are using SDK for UI customization, SDK may be defective. Review the source code of SDK.

Uninstalling the Software

Some scanner malfunctions can be resolved by reinstalling the software. Before reinstalling the software, make sure to completely uninstall any previous installation first.

The following procedure uses the ISIS/TWAIN driver as an example. When following the procedure, read the ISIS/TWAIN driver as the driver used.



! IMPORTANT

As always when uninstalling software, log on using an account with Administrator privileges.

1 From the Windows task bar, click Start button – [Windows System] – [Control Panel].

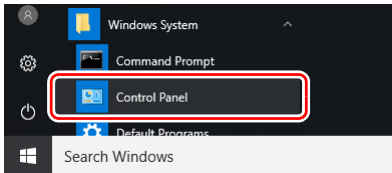

The Control Panel appears.

2 Click [Uninstall a program].

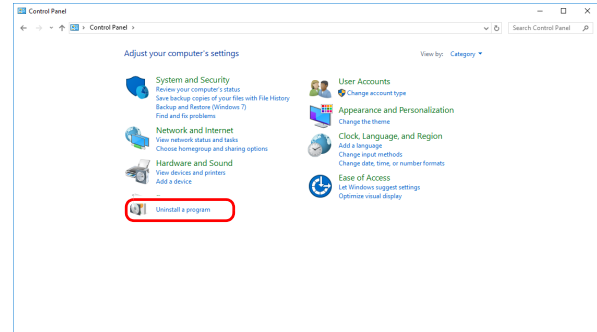

3 From the program list, select the application to be removed and click [Uninstall].

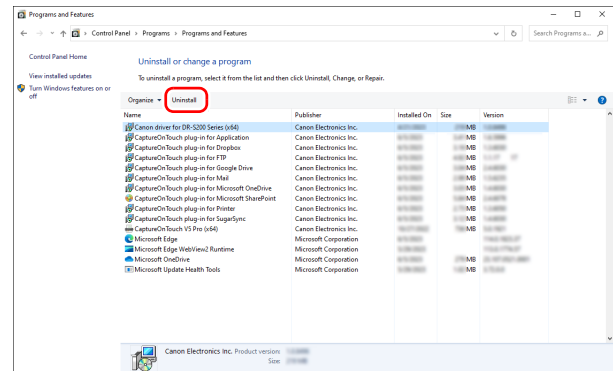

The file-deletion confirmation screen appears.

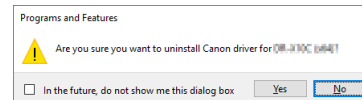

4 Click [Yes] to proceed with uninstallation.

Mac

No uninstaller is provided for macOS drivers. To uninstall, use Finder to delete the following files.

/Library/Image Capture/TWAIN Data Sources/DRS250N

Specifications

Main Unit

Type	Desktop sheetfed scanner
Scanning Document Size	
Plain Paper	
Size:	Width: 50.8 mm to 216 mm (2" to 8.5") Length: 54 mm to 356 mm (2.1" to 14") (You can scan documents up to 5,588 mm (220") long by setting the scanner to the Long Document mode.)
Paper thickness:	Page separation: 27 to 209 g/m ² (7 to 56 lb bond) 0.04 mm to 0.25 mm (0.00157" to 0.00984") Non separation feed: 27 to 255 g/m ² (7 to 68 lb bond) 0.04 mm to 0.3 mm (0.00157" to 0.0118")
Loading capacity:	A4 size or smaller: 60 sheets (80 g/m ² (22 lb bond)) Larger than A4 size: 40 sheets (80 g/m ² (22 lb bond)) Make sure stacks do not exceed 6 mm in height for either of the above.
Business Card	
Size:	Width: 50 mm to 55 mm (2" to 2.2") Length: 85 mm to 91 mm (3.3" to 3.6")
Paper thickness:	128 to 255 g/m ² (34 to 67.8 lb bond) 0.15 mm to 0.3 mm (0.00591" to 0.0118")
Orientation:	Vertical feeding only
Card	
Size:	86 mm x 54 mm (3.37" x 2.12") (ISO standard)
Card thickness:	1.4 mm (0.055") or smaller
Orientation:	Horizontal feeding only
Embossed cards can be scanned.	
Loading capacity:	3 cards (non-embossed), 1 card (embossed)

Passport	
Size:	88 mm x 125 mm (3.464" x 4.921") (ISO standard) When scanning the passport, open the passport and insert it in the separately sold carrier sheet before feeding.
Thickness:	4 mm (0.157") or less (including carrier sheet)
Scanning Sensor	Contact image sensor
Light source	LED
Scanning Side	Simplex/duplex
Scanning modes	Black and White, Error Diffusion, Grayscale, Advanced Text Enhancement, Advanced Text Enhancement II, Active Threshold, Color
Optical resolution	Up to 600 dpi
Output resolution	100dpi/150dpi/200dpi/240dpi/300dpi/400dpi/600dpi/1200dpi
Scanning Speed	(Conditions: Core i7 3.0 GHz CPU, 16 GB memory, A4 document size)
Grayscale	Simplex 200dpi 50 pages/min 300dpi 50 pages/min Duplex 200dpi 100 images/min 300dpi 100 images/min
Color	Simplex 200dpi 50 pages/min 300dpi 40 pages/min Duplex 200dpi 100 images/min 300dpi 80 images/min
Interface	USB 3.2 Gen1x1/ USB2.0 10Base-T/100Base-TX/1000Base-T
Other functions	Folio scanning, double feed detection ignore
External Dimensions	291 mm (11.5")(W) x 267 mm (10.5")(D) x 242 mm (9.5")(H) (With the document feed tray attached and the document eject tray closed) 291 mm (11.5")(W) x 600 mm (23.7")(D) x 378 mm (14.9")(H) (With the document feed tray attached and the document eject tray open)

Weight (without AC adapter)

Approximately 3.4 kg (7.50 lb)

Power Supply (using AC adapter)

DC 24 V 0.8 A

Power Consumption

Scanning: Maximum 22 W or less

In the Sleep mode: 1.6 W

With power OFF: Maximum 0.1 W or less

Operating Environment

Temperature: 10 °C to 35 °C (50 °F to 95 °F)

Humidity: 20% to 80% RH

AC Adapter (100 to 240 V type)

Model Number 6G3-0267 (24V)

Input AC 100 to 240 V, 50/60 Hz, 1.06 to 0.6 A

Output DC 24 V 2.0 A

Weight Approximately 0.3kg (0.66 lb)

Specifications are subject to change without notice due to product improvements.

Replacement parts

Exchange roller kit (product code: 5595C001)

Kit to replace the rollers (feed roller, retard roller).

- For the replacement procedure, "[Replacing Consumable Parts](#)" ([See p. 116](#)).
- Contact your local authorized Canon dealer or service representative for detailed information about the replacement parts.

Option

Carrier sheet (for passports) (product code: 0697C002)

This is a carrier sheet for scanning passports.

Carrier sheet (A4) (product code: 0697C001)

Carrier sheet (LEGAL) (product code: 0697C005)

Flatbed scanner unit 102 (product code: 2152Cxxx)

Flatbed scanner unit that can be connected to and used with a DR scanner. Connecting the unit to this scanner enables you to use this scanner as a flatbed scanner with an automatic document feeder.

About the Flatbed Scanner Unit

Windows

The optional Flatbed Scanner Unit can be connected to and used with this scanner.

System requirements

The computer must comply with the necessary system requirements of Flatbed Scanner Unit.

The scanner driver of Flatbed Scanner Unit needs to be installed to use the unit.

About Use with CaptureOnTouch

About Assigning Function to Start Button

When you connect Flatbed Scanner Unit, you can assign Scanning Shortcut of CaptureOnTouch to the start button of Flatbed Scanner Unit.

Limitation of Restarting with Start Button

When CaptureOnTouch is set not to be resident in memory, CaptureOnTouch cannot be restarted by pressing the start button on Flatbed Scanner Unit after you end CaptureOnTouch.

About Setting up the Scanner Driver

When functions of this scanner cannot be selected with the Flatbed Scanner Unit settings dialog box, click [Option] in the dialog box to open the scanner driver and make the required settings.

Dimensions

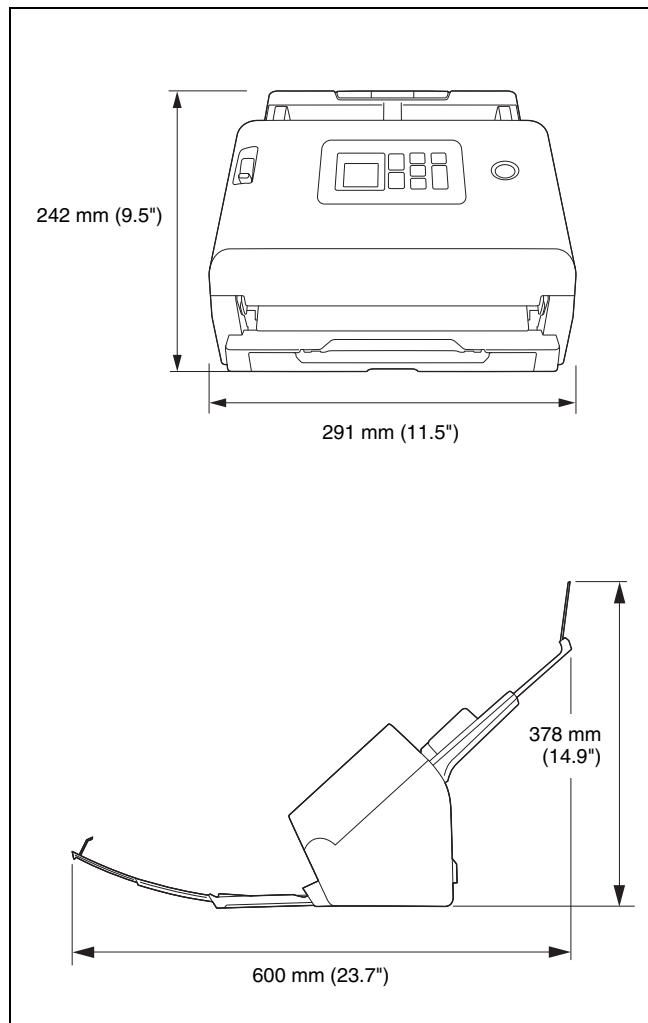

Regulations

FCC REGULATIONS (For 120 V model)

Document Scanner, Model 6130270

AC Adapter, Model 6G3-0267

Note: This equipment has been tested and found to comply with the limits for a Class B digital device, pursuant to Part 15 of the FCC Rules. These limits are designed to provide reasonable protection against harmful interference in a residential installation. This equipment generates, uses, and can radiate radio frequency energy and, if not installed and used in accordance with the instructions, may cause harmful interference to radio communications. However, there is no guarantee that interference will not occur in a particular installation. If this equipment does cause harmful interference to radio or television reception, which can be determined by turning the equipment OFF and ON, the user is encouraged to try to correct the interference by one or more of the following measures:

- Reorient or relocate the receiving antenna.
- Increase the separation between the equipment and receiver.
- Connect the equipment into an outlet on a circuit different from that to which the receiver is connected.
- Consult the dealer or an experienced radio/TV technician for help.

Use of shielded cable is required to comply with Class B limits in Subpart B of Part 15 of FCC Rules.

Do not make any changes or modifications to the equipment unless otherwise specified in the manual. If such changes or modifications should be made, you could be required to stop operation of the equipment.

Canon U.S.A. Inc.

One Canon Park, Melville, NY 11747, U.S.A.

Tel. No. (800)652-2666

RADIO INTERFERENCE REGULATIONS (For 120 V models)

This digital apparatus does not exceed the Class B limits for radio noise emissions from digital apparatus as set out in the interference-causing equipment standard entitled “Digital Apparatus”, ICES-003 of the Industry Canada.

ENERGY STAR® Office Equipment Program



This program is for U.S.A and Canada.

As an ENERGY STAR® Partner, CANON ELECTRONICS INC. has determined that this machine meets the ENERGY STAR® Program guidelines for energy efficiency.

The ENERGY STAR® Office Equipment Program is an international program that promotes energy saving through the use of computers and other office equipment. The program backs the development and dissemination of products with functions that effectively reduce energy consumption. It is an open system in which business proprietors can participate voluntarily. The targeted products are office equipment, such as computers, monitors, printers, fax, machine, copiers, and scanners. The standards and logos are uniform among participating nations.

This model doesn't provide setting options for power management.

Für EMVG

Dieses Produkt ist zum Gebrauch im Wohnbereich, Geschäfts- und Gewerbebereich sowie in Kleinbetrieben vorgesehen.

Model Names

The following name may be provided for the safety regulations in each sales region of the Document Scanner.

DR-S250N: Model 6130270

Reproduction Warning

This device is designed to be used in a legal manner, in accordance with all applicable laws, including, but not limited to, counterfeit and copyright laws, as well as laws pertaining to national security.

Any person(s) found to have reproduced any of the following materials (regardless of whether such reproduction was intentional or not) for the purpose of misrepresenting such material as the original may be prosecuted in accordance with the applicable laws and regulations.

- Paper money or bank notes (domestic and foreign)
- Postage stamps, revenue stamps, or other similar stamps
- Stock certificates, bond certificates, promissory notes, cheques, or other valuable certificates
- Passports, licenses, or other certificates or documents issued by government officials or agencies

This is not an exhaustive list.

Canon is not responsible for how this scanner is used by an individual. Please note that certain intellectual property is protected by copyright law, and copyrighted items may not be reproduced without the express permission of the copyright holder except for personal or household use under limited circumstances.

Trademarks

- Canon and the Canon logo are registered trademarks, of Canon Inc. in the United States and may also be trademarks or registered trademarks in other countries.
- imageFORMULA is a trademark of CANON ELECTRONICS INC.
- Microsoft, Windows, Microsoft Edge, and Microsoft Teams are registered trademarks or trademarks of Microsoft Corporation in the United States and other countries.
- Microsoft product screen shot(s) reprinted with permission from Microsoft Corporation.
- ENERGY STAR® is a registered trademark of the United States Environmental Protection Agency.
- Mac, Mac OS, macOS and Safari are trademarks of Apple Inc. registered in the U.S. and other countries.
- Slack is a trademark or registered trademark of Slack Technologies, Inc. in the United States and other countries.
- iOS is a trademark or registered trademark of Cisco in the United States and other countries.
- Google Chrome, Chrome OS and Android are registered trademarks or trademarks of Google LLC.
- Mopria® is a trademark or registered trademark of Mopria Alliance, Inc. in the United States and other countries. Unauthorized use is strictly prohibited.
- Firefox is a registered trademark of the Mozilla Foundation in the U.S. and other countries.
- ISIS is a registered trademark of Open Text in the United States.
- iDRS™ SDK 15 Windows 32 – 64 bit technology by Image Recognition Integrated Systems S.A. Copyright 1987 – 2019, I.R.I.S. S.A. All rights reserved.
- QR Code is a registered trademark of DENSO WAVE INCORPORATED in Japan and in other countries.
- Other product and company names herein may be the trademarks of their respective owners. However, the ™ and ® symbols are not used in this document.

Copyright

Copyright 2023 by CANON ELECTRONICS INC. All rights reserved. No part of this publication may be reproduced or transmitted in any form or by any means, electronic or mechanical, including photocopying and recording, or by any information storage or retrieval system without the prior written permission of CANON ELECTRONICS INC.

Disclaimers

The information in this document is subject to change without notice.

CANON ELECTRONICS INC. MAKES NO WARRANTY OF ANY KIND WITH REGARD TO THIS MATERIAL, EITHER EXPRESS OR IMPLIED, EXCEPT AS PROVIDED HEREIN, INCLUDING WITHOUT LIMITATION, THEREOF, WARRANTIES AS TO MARKETABILITY, MERCHANTABILITY, FITNESS FOR A PARTICULAR PURPOSE OF USE OR NON-INFRINGEMENT. CANON ELECTRONICS INC. SHALL NOT BE LIABLE FOR ANY DIRECT, INCIDENTAL, OR CONSEQUENTIAL DAMAGES OF ANY NATURE, OR LOSSES OR EXPENSES RESULTING FROM THE USE OF THIS MATERIAL.

CANON ELECTRONICS INC. IS NOT LIABLE FOR THE STORAGE AND HANDLING OF DOCUMENTS SCANNED WITH THIS PRODUCT, OR THE STORAGE AND HANDLING OF RESULTING SCANNED IMAGE DATA.

IF YOU INTEND TO DISCARD THE ORIGINALS OF SCANNED DOCUMENTS, YOU THE CUSTOMER ARE RESPONSIBLE FOR INSPECTING THE SCANNED IMAGES AND VERIFYING THAT DATA IS INTACT.

THE MAXIMUM LIABILITY OF CANON ELECTRONICS INC. UNDER THIS WARRANTY IS LIMITED TO THE PURCHASE PRICE OF THE PRODUCT COVERED BY THE WARRANTY.

Index

B		
Bypass mode	26	
C		
Canon imageFORMULA Driver Setting Tool	120	
CaptureOnTouch		
Exiting	38	
Restarting	39	
Scanning Shortcut	43	
Standard Scanning	41	
Starting	38	
CaptureOnTouch Lite Web		
Scanning	35	
Card		
Loading method	27	
Carrier sheet	29, 151	
COT Admin	103	
Counter	66	
D		
Display	16	
Document	22	
Card	27	
Folio	28	
Loading method	24	
Double Feed Detection	53	
F		
Feed Roller	116, 117	
Flatbed scanner unit 102	152	
Folio	28	
Front Unit	117	
J		
Job		
Computer connected via USB	49, 50	
Computer connected via wired LAN	50	
Scanner	51	
L		
Long Document Mode	53	
M		
Maintenance	113	
Mopria	52	
O		
Operation Panel	16	
P		
Paper jam	143	
Passports	30, 151	
Power supply	20	
R		
Retard Roller	116, 118	
Roller	114	
Cleaning	113	
Replace	116	
S		
Scanning glass	114	
Cleaning	113	
Settings Menu	55	
List	61	
System Requirements	6	
U		
Uninstall	148	
W		
Web Menu	34, 55	
List	60	
Registering a job	107	

WEEE CAUTION



English

Only for European Union and EEA (Norway, Iceland and Liechtenstein)

This symbol indicates that this product is not to be disposed of with your household waste, according to the WEEE Directive (2012/19/EU) and national legislation. This product should be handed over to a designated collection point, e.g., on an authorized one-for-one basis when you buy a new similar product or to an authorized collection site for recycling waste electrical and electronic equipment (EEE).

Improper handling of this type of waste could have a possible negative impact on the environment and human health due to potentially hazardous substances that are generally associated with EEE. At the same time, your cooperation in the correct disposal of this product will contribute to the effective usage of natural resources. For more information about where you can drop off your waste equipment for recycling, please contact your local city office, waste authority, approved WEEE scheme or your household waste disposal service. For more information regarding return and recycling of WEEE products, please visit www.canon-europe.com/sustainability/approach/.

Only for the United Kingdom

This symbol indicates that this product is not to be disposed of with your household waste, according to the UK Waste Electrical and Electronic Equipment Regulations. This product should be handed over to a designated collection point, e.g., on an authorized one-for-one basis when you buy a new similar product or to an authorized collection site for recycling waste electrical and electronic equipment (EEE). Improper handling of this type of waste could have a possible negative impact on the environment and human health due to

potentially hazardous substances that are generally associated with EEE. At the same time, your cooperation in the correct disposal of this product will contribute to the effective usage of natural resources. For more information about where you can drop off your waste equipment for recycling, please contact your local city office, waste authority, approved WEEE scheme or your household waste disposal service. For more information regarding return and recycling of WEEE products, please visit www.canon-europe.com/sustainability/approach/.

Français

Union Européenne, Norvège, Islande et Liechtenstein uniquement.

Ce symbole indique que ce produit ne doit pas être jeté avec les ordures ménagères, conformément à la directive DEEE (2012/19/UE) et à la réglementation de votre pays. Ce produit doit être confié au distributeur à chaque fois que vous achetez un produit neuf similaire, ou à un point de collecte mis en place par les collectivités locales pour le recyclage des Déchets des Équipements Électriques et Électroniques (DEEE). Le traitement inapproprié de ce type de déchet risque d'avoir des répercussions sur l'environnement et la santé humaine, du fait de la présence de substances potentiellement dangereuses généralement associées aux équipements électriques et électroniques. Parallèlement, votre entière coopération dans le cadre de la mise au rebut correcte de ce produit favorisera une meilleure utilisation des ressources naturelles. Pour plus d'informations sur les points de collecte des équipements à recycler, contactez vos services municipaux, les autorités locales compétentes, le plan DEEE approuvé ou le service d'enlèvement des

ordures ménagères. Pour plus d'informations sur le retour et le recyclage des produits DEEE, consultez le site: www.canon-europe.com/sustainability/approach/.

Deutsch

Nur für Europäische Union und EWR (Norwegen, Island und Liechtenstein)

Dieses Symbol weist darauf hin, dass dieses Produkt gemäß der EU-Richtlinie über Elektro- und Elektronik-Altgeräte (2012/19/EU) und nationalen Gesetzen nicht über den Hausmüll entsorgt werden darf. Dieses Produkt muss bei einer dafür vorgesehenen Sammelstelle abgegeben werden. Dies kann z. B. durch Rückgabe beim Kauf eines ähnlichen Produkts oder durch Abgabe bei einer autorisierten Sammelstelle für die Wiederaufbereitung von Elektro- und Elektronik-Altgeräten geschehen. Der unsachgemäße Umgang mit Altgeräten kann aufgrund potentiell gefährlicher Stoffe, die generell mit Elektro- und Elektronik-Altgeräten in Verbindung stehen, negative Auswirkungen auf die Umwelt und die menschliche Gesundheit haben. Durch die umweltgerechte Entsorgung dieses Produkts tragen Sie außerdem zu einer effektiven Nutzung natürlicher Ressourcen bei. Informationen zu Sammelstellen für Altgeräte erhalten Sie bei Ihrer Stadtverwaltung, dem öffentlich-rechtlichen Entsorgungsträger, einer autorisierten Stelle für die Entsorgung von Elektro- und Elektronik-Altgeräten oder Ihrem örtlichen Entsorgungsunternehmen. Weitere Informationen zur Rückgabe und Entsorgung von Elektro- und Elektronik-Altgeräten finden Sie unter www.canon-europe.com/sustainability/approach/.

Zusatzinformationen für Deutschland:

Dieses Produkt kann durch Rückgabe an den Händler unter den in der Verordnung des Elektro- und Elektronikgerätegesetzes beschriebenen Bedingungen abgegeben werden.

Als Endbenutzer und Besitzer von Elektro- oder Elektronikgeräten sind Sie verpflichtet:

- diese einer vom unsortierten Siedlungsabfall getrennten Erfassung zuzuführen,

- Altbatterien und Altakkumulatoren, die nicht von Altgerät umschlossen sind, sowie Lampen, die zerstörungsfrei aus dem Altgerät entnommen werden können, vor der Abgabe an einer Erfassungsstelle vom Altgerät zerstörungsfrei zu trennen,
- personenbezogener Daten auf den Altgeräten vor der Entsorgung zu löschen.

Die Bedeutung von dem Symbol der durchgestrichenen Abfalltonne auf Rädern finden Sie oben in dieser Beschreibung.

Die Vertreiber von Elektro- oder Elektronikgeräten haben die Pflicht zur unentgeltlichen Rücknahme von Altgeräten. Die Vertreiber haben die Endnutzer über die von ihnen geschaffenen Möglichkeiten der Rückgabe von Altgeräten zu informieren.

Italiano

Solo per Unione Europea e SEE (Norvegia, Islanda e Liechtenstein)

Questo simbolo indica che il prodotto deve essere oggetto di raccolta separata in conformità alla Direttiva RAEE (2012/19/UE) e alla normativa locale vigente. Il prodotto deve essere smaltito presso un centro di raccolta differenziata, un distributore autorizzato che applichi il principio dell'"uno contro uno", ovvero del ritiro della vecchia apparecchiatura elettrica al momento dell'acquisto di una nuova, o un impianto autorizzato al riciclaggio dei rifiuti di apparecchiature elettriche ed elettroniche. La gestione impropria di questo tipo di rifiuti può avere un impatto negativo sull'ambiente e sulla salute umana causato dalle sostanze potenzialmente pericolose che potrebbero essere contenute nelle apparecchiature elettriche ed elettroniche. Un corretto smaltimento di tali prodotti contribuirà inoltre a un uso efficace delle risorse naturali ed eviterà di incorrere nelle sanzioni amministrative di cui all'art. 255 e successivi del Decreto Legislativo n. 152/06. Per ulteriori informazioni sullo smaltimento e il recupero dei Rifiuti di Apparecchiature Elettriche ed Elettroniche, consultare la Direttiva RAEE, rivolgersi alle autorità competenti, oppure visitare il sito www.canon-europe.com/sustainability/approach/.

Español

Sólo para la Unión Europea y el Área Económica Europea (Noruega, Islandia y Liechtenstein)

Este símbolo indica que este producto no debe desecharse con los desperdicios domésticos, de acuerdo con la directiva RAEE (2012/19/UE) y con la legislación nacional. Este producto debe entregarse en uno de los puntos de recogida designados, como por ejemplo, entregándolo en el lugar de venta al comprar un producto similar o depositándolo en un lugar de recogida autorizado para el reciclado de residuos de aparatos eléctricos y electrónicos (RAEE). La manipulación inapropiada de este tipo de desechos podría tener un impacto negativo en el entorno y la salud humana, debido a las sustancias potencialmente peligrosas que normalmente están asociadas con los RAEE. Al mismo tiempo, su cooperación a la hora de desechar correctamente este producto contribuirá a la utilización eficaz de los recursos naturales. Para más información sobre cómo puede eliminar el equipo para su reciclado, póngase en contacto con las autoridades locales, con las autoridades encargadas de los desechos, con un sistema de gestión RAEE autorizado o con el servicio de recogida de basuras doméstico. Si desea más información acerca de la devolución y reciclado de RAEE, visite la web www.canon-europe.com/sustainability/approach/.

Nederlands

Uitsluitend bestemd voor de Europese Unie en EER (Noorwegen, IJsland en Liechtenstein)

Dit symbool geeft aan dat dit product in overeenstemming met de AEEA-richtlijn (2012/19/EU) en de nationale wetgeving niet mag worden afgevoerd met het huishoudelijk afval. Dit product moet worden ingeleverd bij een aangewezen, geautoriseerd inzamelpunt, bijvoorbeeld wanneer u een nieuw gelijksoortig product aanschaft, of bij een geautoriseerd inzamelpunt voor hergebruik van elektrische en elektronische apparatuur (EEA). Een onjuiste afvoer van dit type afval kan leiden tot negatieve effecten op het milieu en de volksgezondheid als gevolg van potentieel gevaarlijke stoffen die veel voorkomen in elektrische en elektronische apparatuur (EEA). Bovendien werkt u door een juiste afvoer van dit product mee aan het effectieve gebruik

van natuurlijke hulpbronnen. Voor meer informatie over waar u uw afgedankte apparatuur kunt inleveren voor recycling kunt u contact opnemen met het gemeentehuis in uw woonplaats, de reinigingsdienst, of het afvalverwerkingsbedrijf. U kunt ook het schema voor de afvoer van afgedankte elektrische en elektronische apparatuur (AEEA) raadplegen. Ga voor meer informatie over het inzamelen en recyclen van afgedankte elektrische en elektronische apparatuur naar www.canon-europe.com/sustainability/approach/.

Dansk

Gælder kun i Europæiske Union og EØS (Norge, Island og Liechtenstein)

Dette symbol angiver, at det pågældende produkt ikke må bortskaffes sammen med dagrenovation jf. direktivet om affald af elektrisk og elektronisk udstyr (WEEE) (2012/19/EU) og gældende national lovgivning. Det pågældende produkt skal afleveres på et nærmere specificeret indsamlingssted, f.eks. i overensstemmelse med en godkendt én-til-én-procedure, når du indkøber et nyt tilsvarende produkt, eller produktet skal afleveres på et godkendt indsamlingssted for elektronikaffald. Forkert håndtering af denne type affald kan medføre negative konsekvenser for miljøet og menneskers helbred på grund af de potentielt sundhedsskadelige stoffer, der generelt kan forefindes i elektrisk og elektronisk udstyr. Når du foretager korrekt bortskaffelse af det pågældende produkt, bidrager du til effektiv brug af naturressourcerne. Yderligere oplysninger om, hvor du kan bortskaffe dit elektronikaffald med henblik på genanvendelse, får du hos de kommunale renovationsmyndigheder. Yderligere oplysninger om returnering og genanvendelse af affald af elektrisk og elektronisk udstyr får du ved at besøge www.canon-europe.com/sustainability/approach/.

Norsk

Gjelder kun den europeiske union og EØS (Norge, Island og Liechtenstein)

Dette symbolet indikerer at dette produktet ikke skal kastes sammen med husholdningsavfall, i henhold til WEEE-direktiv (2012/19/EU) og nasjonal lov. Produktet må leveres til et dertil egnet innsamlingspunkt,

det vil si på en autorisert en-til-en-basis når du kjøper et nytt lignende produkt, eller til et autorisert innsamlingssted for resirkulering av avfall fra elektrisk og elektronisk utstyr (EE-utstyr). Feil håndtering av denne typen avfall kan være miljø- og helseskadelig på grunn av potensielt skadelige stoffer som ofte brukes i EE-utstyr. Samtidig bidrar din innsats for korrekt avhending av produktet til effektiv bruk av naturressurser. Du kan få mer informasjon om hvor du kan avhende utrangert utstyr til resirkulering ved å kontakte lokale myndigheter, et godkjent WEEE-program eller husholdningens renovasjonsselskap. Du finner mer informasjon om retur og resirkulering av WEEE-produkter på www.canon-europe.com/sustainability/approach/.

Suomi

Vain Euroopan unionin sekä ETA:n (Norja, Islanti ja Liechtenstein) alueelle.

Tämä tunnus osoittaa, että sähkö- ja elektroniikkalaiteromia koskeva direktiivi (SER-direktiivi, 2012/19/EU) sekä kansallinen lainsäädäntö kieltävät tuotteen hävittämisen talousjätteen mukana. Tuote on vietävä asianmukaiseen keräyspisteeseen, esimerkiksi kodinkoneliikkeeseen uutta vastaavaa tuotetta ostettaessa tai viralliseen sähkö- ja elektroniikkalaiteromun keräyspisteeseen. Sähkö- ja elektroniikkalaiteromun virheellinen käsittely voi vahingoittaa ympäristöä ja ihmisten terveyttä, koska laitteet saattavat sisältää ympäristölle ja terveydelle haitallisia aineita. Lisäksi tuotteen asianmukainen hävittäminen säästää luonnonvaroja. Lisätietoja sähkö- ja elektroniikkalaiteromun keräyspisteistä saat kaupunkien ja kuntien tiedotuksesta, jätehuoltoviranomaisilta, sähkö- ja elektroniikkalaiteromun kierrätysjärjestelmän ylläpitäjältä ja jätehuoltoyhtiöltä. Lisätietoja sähkö- ja elektroniikkalaiteromun keräyksestä ja kierrätyksestä on osoitteessa www.canon-europe.com/sustainability/approach/.

Svenska

Endast för Europeiska unionen och EES (Norge, Island och Liechtenstein)

Den här symbolen visar att produkten enligt WEEE-direktivet (2012/19/EU) och nationell lagstiftning inte får sorteras och slängas som hushållsavfall. Den här produkten ska lämnas in på en därför avsedd insamlingsplats, t.ex. på en återvinningsstation auktoriserad att hantera elektrisk och elektronisk utrustning (EE-utrustning) eller hos handlare som är auktoriserade att byta in varor då nya, motsvarande köps (en mot en). Olämplig hantering av avfall av den här typen kan ha en negativ inverkan på miljön och människors hälsa på grund av de potentiellt farliga ämnen som kan återfinnas i elektrisk och elektronisk utrustning. Din medverkan till en korrekt avfallshantering av den här produkten bidrar dessutom till en effektiv användning av naturresurserna. Kontakta ditt lokala kommunkontor, berörd myndighet, företag för avfallshantering eller ta del av en godkänd WEEE-organisation om du vill ha mer information om var du kan lämna den kasserade produkten för återvinning. För mer information om inlämning och återvinning av WEEE-produkter, se www.canon-europe.com/sustainability/approach/.

Português

Apenas para a União Europeia e AEE (Noruega, Islândia e Liechtenstein)

Este símbolo indica que o produto não deve ser colocado no lixo doméstico, de acordo com a Diretiva REEE (2012/19/UE) e a legislação nacional. Este produto deverá ser colocado num ponto de recolha designado, por exemplo, num local próprio autorizado quando adquirir um produto semelhante novo ou num local de recolha autorizado para reciclar resíduos de equipamentos eléctricos e electrónicos (EEE). O tratamento inadequado deste tipo de resíduo poderá causar um impacto negativo no ambiente e na saúde humana devido às substâncias potencialmente perigosas normalmente associadas aos equipamentos eléctricos e electrónicos. Simultaneamente, a sua cooperação no tratamento correto deste produto contribuirá para a utilização eficaz dos recursos naturais. Para mais informações sobre os locais onde o equipamento poderá

ser reciclado, contacte os serviços locais, a autoridade responsável pelos resíduos, o esquema REEE aprovado ou o serviço de tratamento de lixo doméstico. Para mais informações sobre a devolução e reciclagem de produtos REEE, vá a www.canon-europe.com/sustainability/approach/.

Česká

Pouze Evropská unie a EHP (Norsko, Island a Lichtenštejnsko)

Tento symbol znamená, že podle směrnice o OEEZ (2012/19/EU) a podle vnitrostátních právních předpisů nemá být tento výrobek likvidován s odpadem z domácností. Tento výrobek má být vrácen do sběrného místa, např. v rámci autorizovaného systému odběru jednoho výrobku za jeden nově prodaný podobný výrobek nebo v autorizovaném sběrném místě pro recyklaci odpadních elektrických a elektronických zařízení (OEEZ). Nevhodné nakládání s tímto druhem odpadu by mohlo mít negativní dopad na životní prostředí a lidské zdraví, protože elektrická a elektronická zařízení zpravidla obsahují potenciálně nebezpečné látky. Vaše spolupráce na správné likvidaci tohoto výrobku současně napomůže efektivnímu využívání přírodních zdrojů. Další informace o místech sběru vašeho odpadního zařízení k recyklaci vám sdělí místní úřad vaší obce, správní orgán vykonávající dozor nad likvidací odpadu, sběrný OEEZ nebo služba pro odvoz komunálního odpadu. Další informace týkající se vrácení a recyklace OEEZ naleznete na adrese www.canon-europe.com/sustainability/approach/.

Ελληνικά

Μόνο για την Ευρωπαϊκή Ένωση και τον ΕΟΧ (Νορβηγία, Ισλανδία και Λιχτενστάιν)

Αυτό το σύμβολο υποδηλώνει ότι αυτό το προϊόν δεν πρέπει να απορρίπτεται μαζί με τα οικιακά απορρίμματα, σύμφωνα με την Οδηγία σχετικά με τα Απόβλητα Ηλεκτρικού και Ηλεκτρονικού Εξοπλισμού (ΑΗΗΕ) (2012/19/ΕΕ) και την εθνική σας νομοθεσία. Αυτό το προϊόν πρέπει να παραδίδεται σε καθορισμένο σημείο συλλογής, π.χ. σε μια εξουσιοδοτημένη βάση ανταλλαγής όταν αγοράζετε ένα νέο παρόμοιο προϊόν ή σε μια εξουσιοδοτημένη θέση

συλλογής για την ανακύκλωση των αποβλήτων Ηλεκτρικού και Ηλεκτρονικού Εξοπλισμού (ΗΗΕ). Ο ακατάλληλος χειρισμός αυτού του τύπου αποβλήτων μπορεί να έχει αρνητικό αντίκτυπο στο περιβάλλον και την υγεία του ανθρώπου, λόγω δυνητικών επικίνδυνων ουσιών που γενικά συνδέονται με τον ΗΗΕ. Ταυτόχρονα, η συνεργασία σας όσον αφορά τη σωστή απόρριψη αυτού του προϊόντος θα συμβάλει στην αποτελεσματική χρήση των φυσικών πόρων. Για περισσότερες πληροφορίες σχετικά με τα σημεία όπου μπορείτε να απορρίψετε τον εξοπλισμό σας για ανακύκλωση, επικοινωνήστε με το τοπικό γραφείο της πώλης σας, την υπηρεσία απορριμμάτων, το εγκεκριμένο σχήμα ΑΗΗΕ ή την υπηρεσία απόρριψης οικιακών αποβλήτων. Για περισσότερες πληροφορίες σχετικά με την επιστροφή και την ανακύκλωση των προϊόντων ΑΗΗΕ, επισκεφθείτε την τοποθεσία www.canon-europe.com/sustainability/approach/.

Polski

Tylko dla krajów Unii Europejskiej oraz EOG (Norwegia, Islandia i Liechtenstein)

Ten symbol oznacza, że zgodnie z dyrektywą WEEE dotyczącą zużytego sprzętu elektrycznego i elektronicznego (2012/19/UE) oraz przepisami lokalnymi nie należy wyrzucać tego produktu razem z odpadami gospodarstwa domowego. Produkt należy przekazać do wyznaczonego punktu gromadzenia odpadów, np. firmie, od której kupowany jest nowy, podobny produkt lub do autoryzowanego punktu gromadzenia zużytego sprzętu elektrycznego i elektronicznego w celu poddania go recyklingowi. Usuwanie tego typu odpadów w nieodpowiedni sposób może mieć negatywny wpływ na otoczenie i zdrowie innych osób ze względu na niebezpieczne substancje stosowane w takim sprzęcie. Jednocześnie pozbycie się zużytego sprzętu w zalecany sposób przyczynia się do właściwego wykorzystania zasobów naturalnych. Aby uzyskać więcej informacji na temat punktów, do których można dostarczyć sprzęt do recyklingu, prosimy skontaktować się z lokalnym urzędem miasta, zakładem utylizacji odpadów, skorzystać z instrukcji zatwierdzonej dyrektywą WEEE lub skontaktować się z przedsiębiorstwem zajmującym się wywozem odpadów domowych. Więcej informacji o zwracaniu i recyklingu zużytego sprzętu elektrycznego i elektronicznego znajduje się w witrynie www.canon-europe.com/sustainability/approach/.

Magyar

Csak az Európai Unió és az EGT (Norvégia, Izland és Liechtenstein) országában

Ez a szimbólum azt jelzi, hogy a helyi törvények és a WEEE-irányelv (2012/19/EU) szerint a termék nem kezelhető háztartási hulladékként. A terméket a kijelölt nyilvános gyűjtőpontokon kell leadni, például hasonló cserekészülék vásárlásakor, illetve bármelyik, elektromos és elektronikai berendezésekből származó hulladék (WEEE) átvételére feljogosított gyűjtőponton. Az ilyen jellegű hulladékok a nem megfelelő kezelés esetén a bennük található veszélyes anyagok révén ártalmasak lehetnek a környezetre és az emberek egészségére. Továbbá, a termékből származó hulladék megfelelő kezelésével hozzájárulhat a természetes nyersanyagok hatékonyabb hasznosításához. A berendezésekből származó, újrahasznosítható hulladékok elhelyezésére vonatkozó további tudnivalóért forduljon a helyi önkormányzathoz, a közterület-fenntartó vállalatához, a háztartási hulladék begyűjtését végző vállalatához, illetve a hivatalos WEEE-képviselethez. További tudnivalókat a WEEE-termékek visszajuttatásáról és újrahasznosításáról a www.canon-europe.com/sustainability/approach/.

Slovenský

Platí len pre štáty Európskej únie a EHP (Nórsko, Island a Lichtenštajnsko)

Tento symbol znamená, že podľa Smernice 2012/19/EÚ o odpade z elektrických a elektronických zariadení (OEEZ) a podľa platnej legislatívy Slovenskej republiky sa tento produkt nesmie likvidovať spolu s komunálnym odpadom. Produkt je potrebné odovzdať do určenej zberne, napr. prostredníctvom výmeny za kúpu nového podobného produktu, alebo na autorizované zberné miesto, ktoré spracúva odpad z elektrických a elektronických zariadení (EEZ). Nesprávna manipulácia s takýmto typom odpadu môže mať negatívny vplyv na životné prostredie a ľudské zdravie, pretože elektrické a elektronické zariadenia obsahujú potenciálne nebezpečné látky. Spoluprácou na správnej likvidácii produktu prispějete k účinnému využívaniu prírodných zdrojov.

Ďalšie informácie o mieste recyklácie opotrebovaných zariadení získate od miestneho úradu, úradu životného prostredia, zo schváleného plánu OEEZ alebo od spoločnosti, ktorá zaisťuje likvidáciu komunálneho odpadu. Viac informácií nájdete aj na webovej stránke: www.canon-europe.com/sustainability/approach/.

български

Само за Европейския съюз и ЕИП (Норвегия, Исландия и Лихтенщайн)

Този символ показва, че този продукт не трябва да се изхвърля заедно с битовите отпадъци, съгласно Директивата за ИУЕЕО (2012/19/ЕС) и Вашето национално законодателство. Този продукт трябва да бъде предаден в предназначен за целта пункт за събиране, например на база размяна, когато купувате нов подобен продукт, или в одобрен събирателен пункт за рециклиране на излязло от употреба електрическо и електронно оборудване (ИУЕЕО). Неправилното третиране на този тип отпадъци може да доведе до евентуални отрицателни последици за околната среда и човешкото здраве поради потенциално опасните вещества, които обикновено са свързани с ЕЕО. В същото време Вашето съдействие за правилното изхвърляне на този продукт ще допринесе за ефективното използване на природните ресурси. Повече информация относно местата, където може да предавате излязло от употреба оборудване за рециклиране, може да получите от местните власти, от органа, отговорен за отпадъците и от одобрена система за излязло от употреба ЕЕО или от Вашата местна служба за битови отпадъци. За повече информация относно връщането и рециклирането на продукти от излязло от употреба ЕЕО посетете www.canon-europe.com/sustainability/approach/.

Română

Doar pentru Uniunea Europeană și EEA (Norvegia, Islanda și Liechtenstein)

Acest simbol indică faptul că acest produs nu trebuie aruncat o dată cu reziduurile menajere, în conformitate cu Directiva DEEE (Directiva privind deșeurile de echipamente electrice și electronice) (2012/19/

UE) și legile naționale. Acest produs trebuie transportat la un punct de colectare special, de exemplu un centru care preia produsele vechi atunci când achiziționați un produs nou similar, sau la un punct de colectare autorizat pentru reciclarea deșeurilor provenite de la echipamentele electrice și electronice (EEE). Mănuirea necorespunzătoare a acestor tipuri de deșeuri poate avea un impact negativ asupra mediului înconjurător și sănătății indivizilor, din cauza substanțelor potențial nocive care sunt în general asociate cu EEE. În același timp, cooperarea dvs. la reciclarea corectă a acestui produs va contribui la utilizarea efektivă a resurselor naturale. Pentru mai multe informații privind locurile de reciclare a deșeurilor provenite de la echipamente, contactați biroul primăriei locale, autoritatea responsabilă cu colectarea deșeurilor, schema DEEE aprobată sau serviciul de colectare a deșeurilor menajere. Pentru mai multe informații privind returnarea și reciclarea produselor DEEE, vizitați www.canon-europe.com/sustainability/approach/.

Slovenčina

Samo za Evropsko unijo in EGP (Norveška, Islandija in Lihtenštajn)

Ta simbol pomeni, da tega izdelka v skladu z direktivo OEEO (2012/19/EU) in državno zakonodajo ne smete odvreči v gospodinjske odpadke. Ta izdelek morate odložiti na ustrezno zbiralno mesto, na primer pri pooblaščenem prodajalcu, ko kupite podoben nov izdelek ali na zbiralno mesto za recikliranje električne in elektronske opreme. Neprimerno ravnanje s takšnimi odpadki lahko negativno vpliva na okolje in človekovo zdravje zaradi nevarnih snovi, ki so povezane z električno in elektronsko opremo. S pravilno odstranitvijo izdelka hkrati prispevate tudi k učinkoviti porabi naravnih virov. Če želite več informacij o tem, kje lahko odložite odpadno opremo za recikliranje, pokličite občinski urad, komunalno podjetje ali službo, ki skrbi za odstranjevanje odpadkov, ali si oglejte načrt OEEO. Če želite več informacij o vračanju in recikliranju izdelkov v skladu z direktivo OEEO, obiščite www.canon-europe.com/sustainability/approach/.

Hrvatski

Samo za Europsku uniju i EEA (Norveška, Island i Lihtenštajn)

Ovaj simbol pokazuje da se ovaj proizvod ne smije odlagati s komunalnim i ostalim otpadom sukladno WEEE Direktivi (2012/19/EC) i Pravilniku o gospodarenju otpadnim električnim i elektroničkim uređajima i opremom. Ovaj proizvod je potrebno predati ovlaštenom skupljaču EE otpada ili prodavatelju koji je dužan preuzeti otpadni proizvod po sistemu jedan za jedan, ukoliko isti odgovara vrsti te je obavljao primarne funkcije kao i isporučena EE oprema. Nepropisno rukovanje ovom vrstom otpada može imati negativan učinak na okolinu i zdravlje ljudi zbog supstanci koje su potencijalno opasne za zdravlje, a općenito se povezuju s EEE. Istovremeno, vaša će suradnja kroz propisno odlaganje ovog proizvoda doprinijeti učinkovitoj uporabi prirodnih resursa. Za više informacija o tome gdje možete odložiti svoj otpad za recikliranje obratite se vašem lokalnom gradskom uredu, komunalnoj službi, odobrenom WEEE programu ili službi za odlaganje kućnog otpada. Ostale informacije o vraćanju i recikliranju WEEE proizvoda potražite na www.canon-europe.com/sustainability/approach/.

Català

Només per a la Unió Europea i a l'Espai Econòmic Europeu (Noruega, Islàndia i Liechtenstein)

Aquest símbol indica que aquest producte no s'ha de llençar a les escombraries de la llar, d'acord amb la Directiva RAEE (2012/19/UE) i la legislació nacional. Aquest producte s'hauria de lliurar en un dels punts de recollida designats, com per exemple, intercanviant-lo en un per un en comprar un producte similar o lliurant-lo en un lloc de recollida autoritzat per al reciclatge de residus d'aparells elèctrics i electrònics (AEE). La manipulació inadequada d'aquest tipus de residus podria tenir un impacte negatiu en l'entorn i en la salut humana, a causa de les substàncies potencialment perilloses que normalment estan associades als AEE. Així mateix, la vostra cooperació a l'hora de llençar correctament aquest producte contribuirà a la utilització efectiva dels recursos naturals. Per a més informació sobre els punts on podeu lliurar aquest producte per procedir al seu reciclatge,

adreceu-vos a la vostra oficina municipal, a les autoritats encarregades dels residus, al pla de residus homologat per la RAEE o al servei de recollida de deixalles domèstiques de la vostra localitat. Per a més informació sobre la devolució i el reciclatge de productes RAEE, visiteu www.canon-europe.com/sustainability/approach/.

Eesti

Üksnes Euroopa Liit ja EMP (Norra, Island ja Liechtenstein)

See sümbol näitab, et antud toodet ei tohi vastavalt elektri- ja elektroonikaseadmete jäätmeid käsitlevale direktiivile (2012/19/EL) ning teie riigis kehtivatele õigusaktidele utiliseerida koos olmejäätmetega. Antud toode tuleb anda selleks määratud kogumispunkti, nt müügipunkt, mis on volitatud üks ühe vastu vahetama, kui ostate uue sarnase toote, või elektri- ja elektroonikaseadmete jäätmete ümbertöötlemiseks mõeldud kogumispunkti. Täiendava teabe saamiseks elektri- ja elektroonikaseadmetest tekkinud jäätmete tagastamise ja ümbertöötlemise kohta võtke ühendust kohaliku omavalitsusega, asjakohase valitsusasutusega, asjakohase tootjavastutusorganisatsiooniga või olmejäätmete käitlejaga. Lisateavet leiate ka Interneti-leheküljelt www.canon-europe.com/sustainability/approach/.

Latviešu

Tikai Eiropas Savienībai un EEZ (Norvēģijai, Islandei un Lihtenšteinai)

Šis simbols norāda, ka atbilstoši ES Direktīvai (2012/19/ES) par elektrisko un elektronisko iekārtu atkritumiem (EEIA) un vietējiem tiesību aktiem no šī izstrādājuma nedrīkst atbrīvoties, izmetot to kopā ar sadzīves atkritumiem. Šis izstrādājums ir jānodod piemērotā savākšanas vietā, piemēram, apstiprinātā veikalā, kur iegādājaties līdzīgu jaunu produktu un atstājat veco, vai apstiprinātā vietā izlietotu elektrisko un elektronisko iekārtu pārstrādei. Nepareiza šāda veida atkritumu apsaimniekošana var apdraudēt vidi un cilvēka veselību tādu iespējami bīstamu vielu dēļ, kas parasti ir elektriskajās un elektroniskajās iekārtās. Turklāt jūsu atbalsts pareizā šāda veida

atkritumu apsaimniekošanā sekmēs efektīvu dabas resursu izmantošanu. Lai saņemtu pilnīgāku informāciju par vietām, kur izlietoto iekārtu var nodot pārstrādei, sazinieties ar vietējo pašvaldību, atkritumu savākšanas atbildīgo dienestu, pilnvarotu EEIA struktūru vai sadzīves atkritumu apsaimniekošanas iestādi. Lai saņemtu plašāku informāciju par elektrisko un elektronisko iekārtu nodošanu pārstrādei, apmeklējiet tīmekļa vietni www.canon-europe.com/sustainability/approach/.

Lietuvių

Tik Europos Sąjungai ir EEE (Norvegijai, Islandijai ir Lichtenšteiniui)

Šis ženklas reiškia, kad gaminio negalima išmesti su buitinėmis atliekomis, kaip yra nustatyta Direktyvoje (2012/19/ES) ir nacionaliniuose teisė aktuose dėl EEJ atliekų tvarkymo. Šį gaminį reikia atiduoti į tam skirtą surinkimo punktą, pvz., pagal patvirtintą keitimo sistemą, kai perkamas panašus gaminytis, arba į elektros ir elektroninės įrangos (EEJ) atliekų perdirbimo punktą. Netinkamas tokios rūšies atliekų tvarkymas dėl elektros ir elektroninėje įrangoje esančių pavojingų medžiagų gali pakenkti aplinkai ir žmonių sveikatai. Padėdami užtikrinti tinkamą šio gaminio šalinimo tvarką, kartu prisidėsite prie veiksmingo gamtos išteklių naudojimo. Jei reikia daugiau informacijos, kaip šalinti tokias atliekas, kad jos būtų toliau perdirbamos, kreipkitės į savo miesto valdžios institucijas, atliekų tvarkymo organizacijas, patvirtintų EEJ atliekų sistemų arba jūsų buitinių atliekų tvarkymo įstaigų atstovus. Išsamesnės informacijos apie EEJ atliekų gražinimo ir perdirbimo tvarką galite rasti apsilankę tinklalapyje www.canon-europe.com/sustainability/approach/.

Srpski

Ovaj simbol označava da ovaj proizvod ne sme da se odlaže sa ostalim kućnim otpadom, u skladu sa WEEE Direktivom (2012/19/EU) i nacionalnim zakonima. Ovaj proizvod treba predati određenom centru za prikupljanje, npr. na osnovi "jedan-za-jedan" kada kupujete sličan novi proizvod, ili ovlašćenom centru za prikupljanje za reciklažu istrošene električne i elektronske opreme (EEE). Nepravilno rukovanje ovom vrstom otpada može da ima moguće negativne posledice po životnu sredinu i ljudsko zdravlje usled potencijalno

opasnih materijala koji se uglavnom vezuju za EEE. U isto vreme, vaša saradnja na ispravnom odlaganju ovog proizvoda će doprineti efikasnom korišćenju prirodnih resursa. Za više informacija o tome gde možete da predate vašu staru opremu radi recikliranja, vas molimo, da kontaktirate lokalne gradske vlasti, komunalne službe, odobreni plan reciklaže ili Gradsku čistoću. Za više informacija o vraćanju i recikliranju WEEE proizvoda, posetite stranicu www.canon-europe.com/sustainability/approach/.

Српски

Ovaj simbol označava da ovaj proizvod ne sme da se odlaže sa ostalim kućnim otpadom, u skladu sa WEEE Direktivom (2012/19/EU) i nacionalnim zakonima. Ovaj proizvod treba predati određenom centru za prikupljanje, npr. na osnovi "staro za novo" kada kupujete sličan novi proizvod, ili ovlašćenom centru za reciklažu istrošene električne i elektronske opreme (EEE). Nepravilno rukovanje ovom vrstom otpada može da ima moguće negativne uticaje po životnu sredinu i ljudsko zdravlje usled potencijalno opasnih materijala koje se uglavnom vezuju za EEE. U isto vreme, vaša saradnja na ispravnom odlaganju ovog proizvoda će doprineti efikasnom korišćenju prirodnih resursa. Za više informacija o tome gde možete da predate vašu staru opremu radi recikliranja, molimo Vas da kontaktirate lokalne gradske vlasti, komunalne službe, odobreni plan reciklaže ili Gradsku čistoću. Za više informacija o vraćanju i recikliranju WEEE proizvoda, posetite stranicu www.canon-europe.com/sustainability/approach/.

Safety-related markings on the machine

Marquages de sécurité sur la machine

Marcatore di sicurezza sulla macchina

Sicherheitshinweise auf der Maschine

Marcas de la máquina relacionadas con la seguridad

Veiligheidsmarkeringen op de machine

Makine üzerindeki güvenlik işaretleri



[English]	Switch (On)	Power on
[Français]	Commutateur (Marche)	Sous tension
[Italiano]	Interruttore (On)	Alimentazione presente
[Deutsch]	Schalter (Ein)	Eingeschaltet
[Español]	Interruptor (encendido)	Máquina encendida
[Nederlands]	Schakelaar (On)	Aan
[Türkçe]	Anahtar (Açık)	Güç açık



[English]	Switch (Off)	Power off (no standby current)
[Français]	Commutateur (Arrêt)	Hors tension (pas de courant de veille)
[Italiano]	Interruttore (Off)	Alimentazione assente (nessuna corrente di standby)
[Deutsch]	Schalter (Aus)	Ausgeschaltet (ohne Ruhestromaufnahme)
[Español]	Interruptor (apagado)	Máquina apagada (sin corriente en espera)
[Nederlands]	Schakelaar (Off)	Uit (geen stand-byverbruik)
[Türkçe]	Anahtar (Kapalı)	Güç kapalı (bekleme akımı yok)



[English]	Switch (Standby)	Power on/off (standby current on)
[Français]	Commutateur (Veille)	Sous/hors tension (courant de veille activé)
[Italiano]	Interruttore (Standby)	Alimentazione on/off (corrente di standby presente)
[Deutsch]	Schalter (Standby)	Ein- und Ausschalten (mit Ruhestromaufnahme)
[Español]	Interruptor (en espera)	Máquina apagada/encendida (con corriente en espera)
[Nederlands]	Schakelaar (Standby)	Aan-uit (stand-byverbruik aan)
[Türkçe]	Anahtar (Bekleme)	Güç açık/kapalı (bekleme akımı açık)



[English]	Switch (Push-On/Push-Off)	Power on/off (no standby current)
[Français]	Commutateur (Appuyer pour mettre en marche/Appuyer pour arrêter)	Sous/hors tension (pas de courant de veille)
[Italiano]	Interruttore a pulsante bistabile (On/Off)	Alimentazione on/off (nessuna corrente di standby)
[Deutsch]	Schalter (Ein- und Ausschalten durch Drücken)	Ein- und Ausschalten (ohne Ruhestromaufnahme)
[Español]	Interruptor (pulsado para encendido/apagado)	Encendido/apagado (sin corriente en espera)
[Nederlands]	Schakelaar (Push-On/Push-Off)	Aan-uit (geen stand-byverbruik)
[Türkçe]	Anahtar (Bas-Aç/Bas-Kapa)	Güç açık/kapalı (bekleme akımı yok)



[English]	Heat hazard	Heat hazard
[Français]	Danger de chaleur	Danger de chaleur
[Italiano]	Pericolo: temperature elevate	Pericolo: temperature elevate
[Deutsch]	Überhitzungsgefahr	Überhitzungsgefahr
[Español]	Peligro de calentamiento	Peligro de calentamiento
[Nederlands]	Verbrandingsgevaar	Verbrandingsgevaar
[Türkçe]	Isı tehlikesi	Isı tehlikesi



[English]	Class II equipment	Indicates this is Class II equipment
[Français]	Équipement de classe II	Indique qu'il s'agit d'un équipement de classe II
[Italiano]	Apparecchio classe II	Indica che questo è un apparecchio di classe II
[Deutsch]	Gerät der Schutzklasse II	Gibt an, dass das Gerät der Schutzklasse II entspricht
[Español]	Equipo de clase II	Indica que se trata de un equipo de clase II
[Nederlands]	Klassell-apparatuur	Geeft aan dat deze apparatuur in Klasse II hoort
[Türkçe]	Sınıf II ekipman	Bunun Sınıf II ekipman olduğunu gösterir



[English]	DC symbol	Indicates direct current
[Français]	Symbole CC	Indique qu'il s'agit de courant continu
[Italiano]	Simbolo corrente continua (C.C.)	Indica la corrente continua
[Deutsch]	Gleichstrom-Symbol	Kennzeichnet Gleichstrom
[Español]	Símbolo CC	Indica corriente continua
[Nederlands]	DC-pictogram	Geeft gelijkstroom aan
[Türkçe]	DC sembolü	Düz akımı gösterir



[English]	DC polarity	Indicates the power plug polarity
[Français]	Polarité CC	Indique la polarité de la fiche d'alimentation
[Italiano]	Polarità C.C.	Indica la polarità dello spinotto di alimentazione
[Deutsch]	Gleichstrompolarität	Gibt die Polarität des Netzsteckers an
[Español]	Polaridad de CC	Indica la polaridad del conector de alimentación
[Nederlands]	DC-polariteit	Geeft de polariteit van de stekker aan
[Türkçe]	DC polaritesi	Fiş polaritesini gösterir



[English]	Electrostatic precaution	Avoid applying static electricity to the machine
[Français]	Précaution électrostatique	Évitez de soumettre cette machine à de l'électricité statique
[Italiano]	Protezione dalle cariche elettrostatiche	Evitare di applicare cariche elettrostatiche alla macchina
[Deutsch]	Warnung vor elektrostatischer Aufladung	Elektrostatische Aufladung der Maschine vermeiden
[Español]	Precaución electroestática	No aplique electricidad electroestática
[Nederlands]	Elektrostatische voorzorgen	Voorkom statische elektriciteit op de machine
[Türkçe]	Elektrostatik önlemleri	Makineye statik elektrik vermeyin



CANON ELECTRONICS INC.

3-5-10 SHIBAKOEN, MINATO-KU, TOKYO 105-0011, JAPAN

CANON U.S.A. INC.

ONE CANON PARK, MELVILLE, NY 11747, U.S.A.

CANON CANADA INC.

8000 Mississauga Road Brampton, Ontario L6Y 5Z7, CANADA

CANON EUROPA N.V.

BOVENKERKERWEG 59, 1185 XB AMSTELVEEN, THE NETHERLANDS

CANON AUSTRALIA PTY. LTD.

BUILDING A, THE PARK ESTATE, 5 TALAVERA ROAD, MACQUARIE PARK, NSW 2113, AUSTRALIA

CANON SINGAPORE PTE. LTD.

1 FUSIONPOLIS PLACE, #14-10, GALAXIS, SINGAPORE 138522

CANON KOREA INC.

607, TEHERAN-RO, GANGNAM-GU, SEOUL, KOREA

CANON INDIA PVT. LTD

7TH FLOOR, TOWER B DLF CYBER TERRACES DLF PHASE III GURGAON - 122002 HARYANA, INDIA

CANON EURASIA GÖRÜNTÜLEME VE OFİS SİSTEMLERİ ANONİM ŞİRKETİ

KOZYATAĞI, DEĞİRMEN SOK. NİDA KULE İŞ MERKEZİ NO. 18 KADIKÖY