

**Insta360 Ace Pro**

CO-ENGINEERED WITH

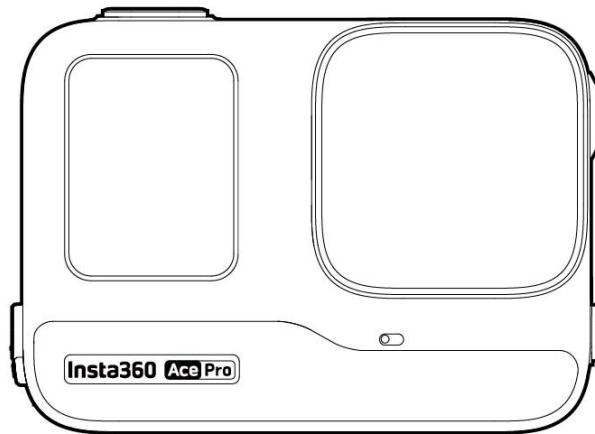

# User Manual



# Content

Product Introduction	1
Ace Pro Introduction	1
Standard Accessories	2
First Use	4
Insert the Battery	4
Insert the MicroSD Card	5
External Devices	5
Charging	6
Activation	7
Basic Use	8
Button Instructions:	8
Using the Screen	10
Shooting Mode	13
Indicator Lights	20
File Storage	22
Exclusive Features	23
Gesture Control	23
Clarity Zoom	23
Cancel Recording	23
Pause Recording	24
Photo Grab	24

Auto Dash	25
AI Warp	25
AI Selfie Stick Eraser	25
AI Highlights Assistant	26
app Background Downloading	26
GPS Preview Remote	27
File Transfer	33
Insta360 App	错误! 未定义书签。
Connect to the Insta360 App	36
Android Mode	36
app Interface	36
Maintenance	37
Firmware Update	37
Waterproofing	38
Cleaning	39
Battery Precautions	39

## Product Introduction

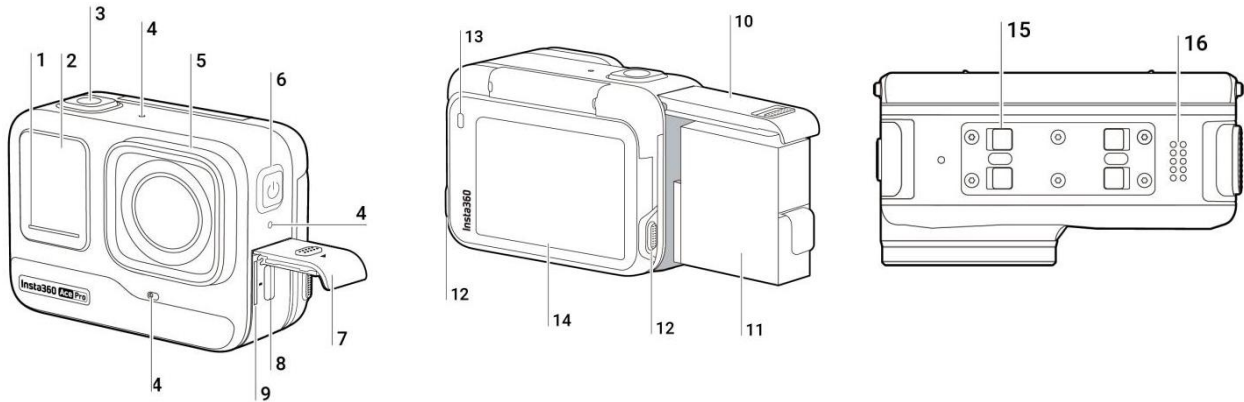

### Ace Pro Introduction



- |                      |                      |
|----------------------|----------------------|
| 1. Indicator Light   | 10. Battery Cover    |
| 2. Front Screen      | 11. Battery          |
| 3. Shutter Button    | 12. Release Switch   |
| 4. Microphone        | 13. Indicator Light  |
| 5. Lens              | 14. Flip Touchscreen |
| 6. Power Button      | 15. Mounting Latch   |
| 7. USB Port Cover    | 16. Speaker          |
| 8. USB Type-C Port   |                      |
| 9. MicroSD Card Slot |                      |

## Standard Accessories

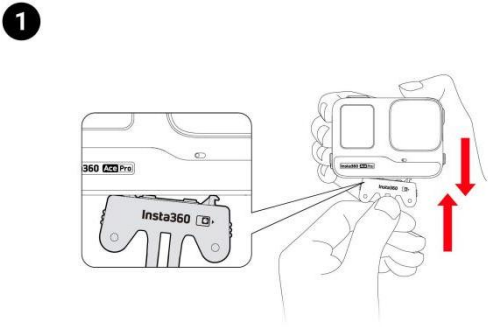
Ace Pro includes two in-the-box accessories for flexible shooting wherever you go.

Accessories	Description	Figure
<p><b>Standard Mount:</b> Secure your camera to any accessory for ultra-stable shots with the universal 2-prong mount. Magnetic design for quick assembly and disassembly.</p> 	<p><b>How to Use:</b></p> <ol style="list-style-type: none"> <li>Align the camera lens with the icon on the Standard Mount and attach the mount.</li> <li>Press the Standard Mount against the camera until you hear a click. Then, gently pull away from the camera to ensure it is attached and properly installed.</li> <li>Press and hold the buttons on both sides of the Standard Mount at the same time to remove the camera.</li> </ol> <p><b>Expanded use:</b> Standard Mount can realize the connection between the camera and the three-jaw interface accessories, and can be externally connected to the Flexible Adhesive Mount and other accessories.</p>	 <p>1</p>  <p>2</p>

**Flexible Adhesive**

**Mount:**

Flexible design with a strong 3M adhesive base that can be used on flat, curved surfaces and in complex environments. Heat and humidity resistant.

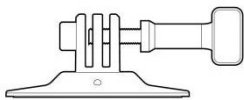

**How to Use:**

1. Peel off the red sticker on the bottom of the Flexible Adhesive Mount and clean the base with a cleaning wipe before use.  
Stick to the surface and press and hold for 30 seconds.
2. Attach the Standard Mount. Tighten the screw to ensure it is stable.
3. Attach the camera to the Standard Mount.

**Notes:**

- The adhesive base is a one-time use only. If it detaches from the surface, it cannot be reused.
- The product should be mounted to a smooth, clean surface, such as glass, ceramic, plastic, painted surfaces, metal, etc.
- The mount can be directly connected to a camera or used with a carbon fiber extension rod on a helmet. It cannot be used with any selfie sticks.

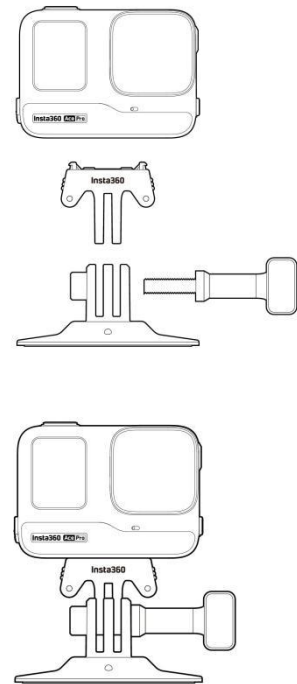

## First Use

### Insert the Battery

1. Press and hold the latch of the Battery Cover and slide it downwards.
2. When you see the yellow indication mark, open the cover outward.
3. Insert the battery in the direction indicated on the battery.
4. Close the cover and ensure the yellow indication mark is completely covered to ensure waterproofing is not affected.

1



2

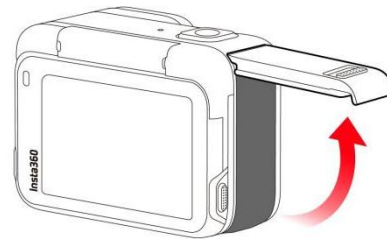

3

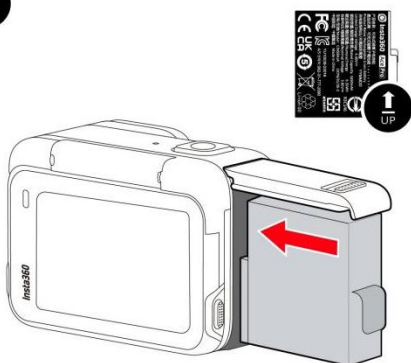

4



## Insert the MicroSD Card

1. Press and hold the latch of the USB Port Cover and slide it downwards.
2. Insert the MicroSD Card in the direction indicated on the card.

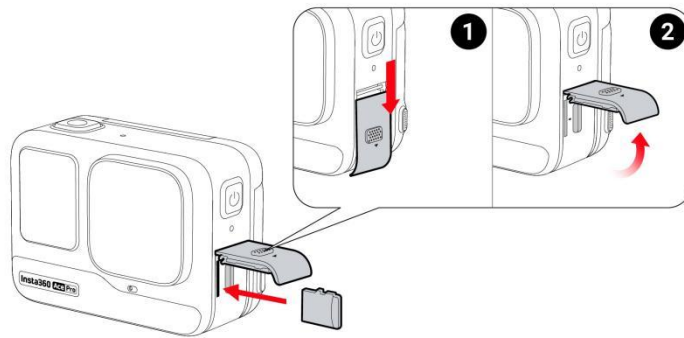

### Note:

Please use exFAT format microSD cards of speed classes UHS-I and V30 or above to ensure normal recording. The maximum supported storage space is 1TB.

## External Devices

1. Hold the protective cover of the camera's MicroSD card slot against the protruding part of the cover in the direction shown in the illustration, and pull out the cover completely in the direction indicated by the arrow;
2. Open the cover outward and pull it out firmly ;
3. After pulling out the cover, you can insert the flash companion and audio adapter;
4. After use, align the inner notch on the top of the protective cover with the silver metal snap above the slot compartment.



## Charging

Open the camera's USB Port Cover. Use the Type-C to Type-C charging cable included in the box to connect the Type-C port of Ace Pro to a Type-C charger.

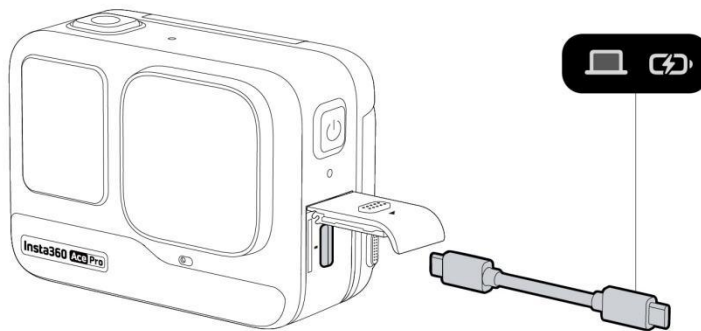

Rapid PD Fast Charging gets your camera to 80% battery in just 22 minutes and fully charges in 46 minutes.

### Ace Pro Charging Time:

- PD Fast Charging: 46 minutes - 100%
- Normal Charging: 63 minutes - 100%

\*The Indicator Lights will be solid red when charging and will turn off once the battery is fully charged.

## Activation

You need to activate Ace Pro in the Insta360 App before using it for the first time.

Steps:

1. Download the Insta360 App. Alternatively, search "Insta360" in any major app store or scan the QR code on the box.
2. Press the Power Button to turn on Ace Pro.
3. Enable Wi-Fi and Bluetooth on your smartphone.
4. Open the Insta360 App and click the camera at the bottom of the page. Select the device you want to connect to in the pop-up window, then follow the on-screen instructions to complete the connection. The name of your camera is "Ace Pro \*\*\*\*\*" by default, where \*\*\*\*\* is the last six digits of the serial number on the box your Ace Pro came in. The first time you connect to Ace Pro, you will need to confirm the connection on the touchscreen.
5. After successfully connecting the camera, follow the on-screen instructions to activate your camera. The app will prompt you to update the firmware if a new version is available. Please follow the on-screen prompts to update the firmware of Ace Pro.

## Basic Use

### Button Instructions:

#### Power Button



Camera Status	Operation	Descriptions
Powered off	Press once	<ul style="list-style-type: none"> <li>Power on camera.</li> </ul>
Powered on	Press once	<ul style="list-style-type: none"> <li>Switch between different shooting modes or presets.</li> <li>When recording, press to mark clips as important. You can find then find marked clips quicker when you are editing.</li> </ul>
	Long press	<ul style="list-style-type: none"> <li>1 second: Power off.</li> <li>5 seconds: Force shutdown.</li> </ul>

## Shutter Button



Camera Status	Operation	Descriptions
Powered off	Press once	<ul style="list-style-type: none"> <li>Start shooting with QuickCapture*.</li> </ul> <p><i>*This function must be enabled in the camera first.</i></p>
Powered on	Press once	<ul style="list-style-type: none"> <li>During Preview:                             <ul style="list-style-type: none"> <li>Take a photo or start recording a video.</li> <li>Stop recording.</li> </ul> </li> <li>In other pages:                             <ul style="list-style-type: none"> <li>Return to the preview page.</li> </ul> </li> </ul>
	Long press	<ul style="list-style-type: none"> <li>During recording :                             <ul style="list-style-type: none"> <li>Quickly cancel recording.</li> </ul> </li> </ul>

## Release Switch

Operation	Descriptions
Press the buttons on each side of the flip screen at the same time.	<ul style="list-style-type: none"> <li>Change the angle of the touchscreen.</li> </ul>

## Using the Screen

### Front Screen



Once the camera is turned on, the front screen will display the following information:

Camera Status	Descriptions
Previewing	Battery, storage capacity, shooting specifications, current shooting mode.
Shooting	Shooting status i.e., paused, pre-recording, countdown, etc.
Other	Footage saving, connecting to app, firmware upgrade, etc.

## Flip Touchscreen

The touchscreen's main display shows the current camera shooting mode. The menu bar shows battery level, storage capacity, and current shooting parameters. By swiping or tapping the screen, you can achieve the following:



### Tap the screen

Hide/show information on the touchscreen.

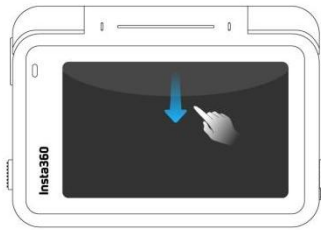

### Swipe down from the top

Enter the camera settings.

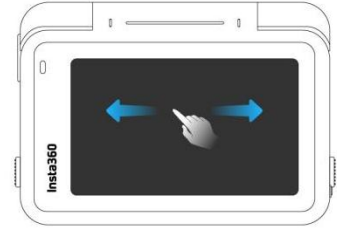

### Swipe left and right in the center

Switch shooting mode.

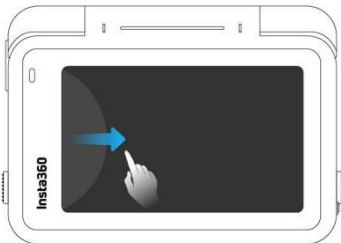

### Swipe from the left

Enter the album page.

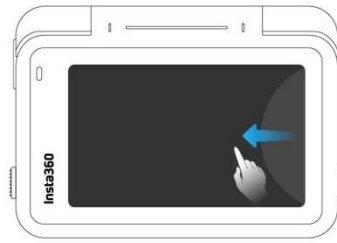

### Swipe from the right

Enter the shooting parameter settings.

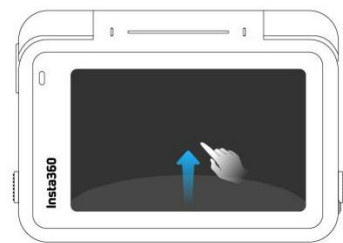

### Swipe up from the bottom

More shooting parameter settings.

## Shortcut Menu

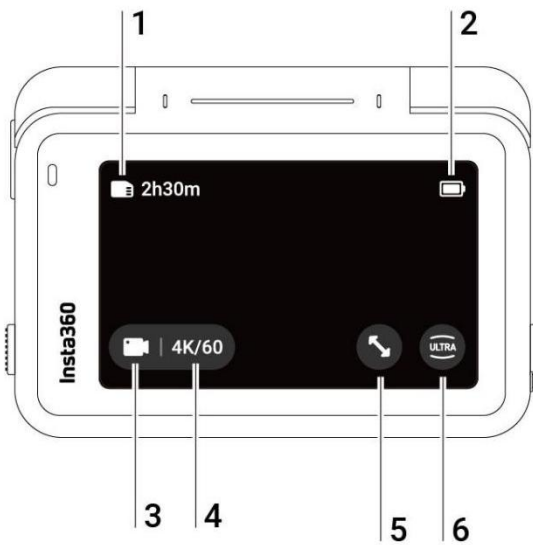

1. **Storage:** Shows the remaining number of photos or the length of video footage that can be stored on the microSD card.
2. **Battery Status:** Current battery level of Ace Pro.
3. **Shooting Mode:** Click the icon and swipe to select a different shooting mode.
4. **Shooting Specifications:** See the current shooting mode settings.
5. **Clarity Zoom:** Click the icon or double-tap the screen to zoom in or out without compromising image quality.
6. **Field of View:** Change the Field of View.

## Shooting Mode

Click the icon and swipe or swipe left and right in the center of the screen to select a different shooting mode.

Shooting Mode	Description
Video	Record a video with FlowState Stabilization automatically applied.
FreeFrame Video	apply FlowState Stabilization and Horizon Lock with adjustable aspect ratio in post via the app or Studio.
PureVideo	PureVideo improves image quality in low light environments.
TimeShift	TimeShift video can be used while moving to create a hyperlapse effect.
Timelapse	Suitable for shooting static timelapse videos.
Loop Recording	Record continuously and save only the last fixed-length segment.
Slow Motion	Shoot Slow Motion video with a high frame rate.
Starlapse	Shoot and store multiple photos and automatically combine Starlapse effects.
Burst Photos	Take multiple photos in a short space of time.
Interval	The camera automatically takes continuous photos at a specific time interval.



HDR Photo	For high dynamic range photos. Please keep the camera still while shooting.
Photo	Take a single photo.

## Camera Settings

Swipe down on the touchscreen to view the camera settings.

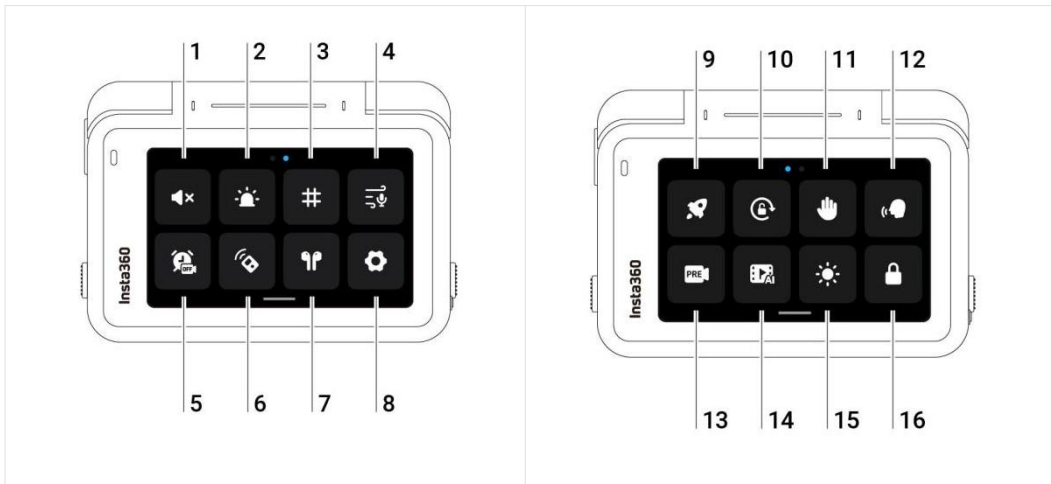

1. **Prompt Sound:** Set the camera speaker volume. There are four options: High, Medium, Low, and Mute.
2. **Indicator Light:** Turn on/off.
3. **Grid:** Turn on/off.
4. **Audio:** Switch audio mode. Choose between Stereo, Wind Reduction or Direction Focus.
5. **Timed Capture:** Use the Timed Capture function.
6. **Bluetooth Remote:** Search for and connect a Bluetooth remote.
7. **AirPods:** Search for and connect AirPods.
8. **Settings:** See camera settings.
9. **QuickCapture:** Turn on/off. Once enabled, press the Shutter Button when the camera is powered off to turn it on and start recording.
10. **Rotation Lock:** Turn on/off.
11. **Gesture Control:** Turn on/off.
12. **Voice Control:** Turn on/off.
13. **Pre-recording:** Turn on/off. Save **15 or 30 seconds** of footage before you start recording.
14. **AI Highlights Assistant:** Turn on/off. The camera finds the best moments from a single video and shows you the highlights to review. Merge them into one video or save each of them as new files. View them on the Album page.
15. **Adjust Brightness:** Slide the bar to adjust the screen brightness.
16. **Lock Screen:** Tap to lock screen. Swipe up on the touchscreen to unlock.

## Shooting Specification Settings

Swipe up from the bottom of the touchscreen to view shooting specification settings.



Shooting Mode	Parameters
Video	Stabilization, Ratio, Duration, Resolution, Frame Rate
FreeFrame Video	Ratio, Duration, Resolution, Frame Rate
PureVideo	Ratio, Duration, Resolution, Frame Rate
TimeShift	Stabilization, Ratio, Duration
Timelapse	Stabilization, Ratio, Duration, Interval
Loop Recording	Stabilization, Ratio, Loop Duration, Resolution, Frame Rate
Slow Motion	Stabilization, Ratio, Duration, Resolution, Frame Rate
Starlapse	Type, Ratio, Duration, Resolution, Timer
Burst	Burst, Ratio, Cache, Resolution, Timer
Interval	Interval, Type, Ratio, Duration, Resolution, Timer
HDR Photo	Format, Ratio, Resolution, Timer
Photo	Format, Ratio, Resolution, Timer

## Shooting Parameter Settings

Swipe left from the right edge of the touchscreen to see the shooting parameter settings.

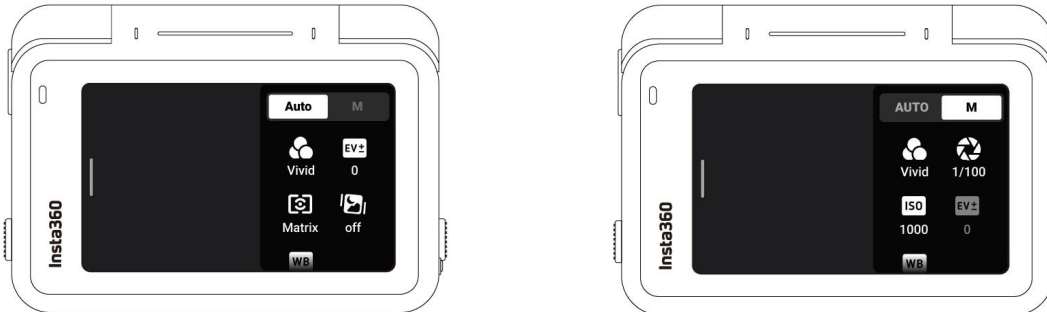

Parameters	Descriptions
Shutter Speed	The time it takes for light to enter the camera. The faster the shutter speed, the clearer the image.
Sensitivity (ISO)	Reflects how sensitive the sensor is to light. A higher sensitivity means the camera can capture more light for a brighter image.
Exposure Compensation Value (EV)	In Auto Mode, you can adjust the EV to help with overexposure or underexposure.
White Balance (WB)	Removes unrealistic colors and tones so colors are accurately captured in the image.
Low Light Stabilization	Improves motion blur and stabilization in low light environments. In extreme environments, the image will be darker and may have some flickering.
Filter	Add different color tones and effects.
Face Priority	Prioritizes the face for brightness.

Shooting Mode	Parameters	
	Auto	Manual
Video	Filters, EV, Face Priority, Low Light Stabilization, WB	Filters, Shutter, ISO, EV, WB
FreeFrame Video	Filters, EV, Face Priority, Low Light Stabilization, WB	Filters, Shutter, ISO, EV, WB
PureVideo	EV, Low Light Stabilization, WB	Shutter, ISO, EV, WB
TimeShift	Filters, EV, WB	Filters, Shutter, ISO, EV, WB
Timelapse	Filters, EV, WB	Filters, Shutter, ISO, EV, WB
Loop Recording	Filters, EV, Face Priority, Low Light Stabilization, WB	Filters, Shutter, ISO, EV, WB
Slow Motion	Filters, EV, WB	Filters, Shutter, ISO, EV, WB
Starlapse	Filters, Shutter, ISO, WB, EV	Shutter, ISO, EV, WB
Burst Photo	Filters, EV, WB	Filters, Shutter, ISO, EV, WB
Interval	Filters, EV, WB	Filters, Shutter, ISO, EV, WB
HDR Photo	Face Priority, WB	Face Priority, WB
Photo	Filters, EV, Face Priority, WB	Filters, Shutter, ISO, EV, WB

## Album Page

Swipe right from the left of the touchscreen to enter the Album page.

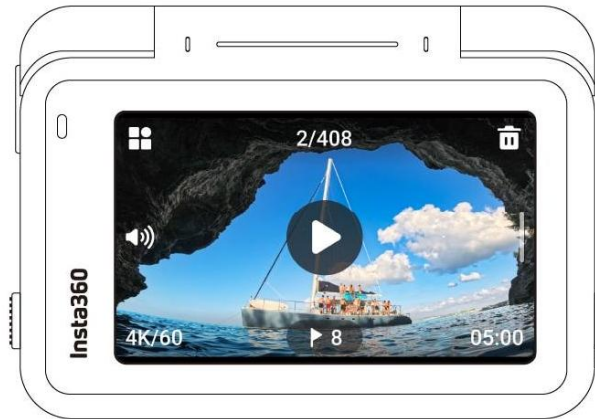

## Indicator Lights

Ace Pro has two LED Indicator Lights, one on the front of the camera and one on the back. Both display the same information. You can turn the Indicator Lights on/off in Settings > General.

Camera Status	Indicator Light Status
Powered on	Solid cyan
Start shooting with QuickCapture	Flashing cyan three times
Standby/standby (charging)/standby (fully charged)	Solid cyan
Stop shooting with Quick Capture	Flashing cyan five times
Charging (powered off)	Solid red (turns off when fully charged)
Recording a video	Flashing red
Countdown >1s	Flashing cyan
Countdown ≤1s	Flashing cyan five times
U-Disk Mode	Solid cyan
Updating firmware	Slowly flashing blue

Insufficient storage/file error/USB error/no SD card	Solid yellow
Temperature is too high	Flashing yellow three times
Low battery/temperature is too high and camera will start auto shutdown countdown	Continuously flashing yellow
<b>Camera Status</b>	<b>Indicator Light Status</b>
Powered on	Solid cyan



## File Storage

Please use exFAT format microSD cards of speed classes UHS-I and V30 or above to ensure normal recording. The maximum supported storage space is 1TB.



We recommend using the official memory card available on the Insta360 Store. If you wish to use another memory card, the following have also been tested to be compatible with Ace Pro:

Micro SD Cards	Model Number	Capacity	Speed Class
Sandisk Extreme V30 A1	SDSQXVF-032G-GN6MA	32GB	V30
Sandisk Extreme Pro V30 A1	SDSQXCG-032G-GN6MA	32GB	V30
Sandisk Extreme Pro V30 A1	SDSQXCG-064G-GN6MA	64GB	V30
Sandisk Extreme V30 A1	SDSQXAF-128G-GN6MA	128GB	V30
Sandisk Extreme V30 A2	SDSQXAF-128G-GN6MA	64GB	V30
Sandisk Extreme V30 A2	SDSQXA1-256G-ZN6MA	256GB	V30
Sandisk Extreme Pro V30 A2	SDSQXCZ-1T00-ZN6MA	1TB	V30
Lexar 1066x microSD UHS-I SILVER Series	LMS1066064G-BN	64GB	V30
Lexar 1066x microSD UHS-I SILVER Series	LMS1066128G-BN	128GB	V30
Lexar 1066x microSD UHS-I SILVER Series	LMS1066256G-BN	256GB	V30

## Exclusive Features

### Gesture Control

You can control the camera with gestures, perfect for group selfies or noisy environments. Enable Gesture Control on your camera, then give the sign to start/stop recording or take a photo. Swipe down on the touchscreen and turn on Gesture Control.

Gesture	Trigger Control
 <p>Peace Sign</p>	Take photo with countdown timer.
 <p>Palm</p>	Start/stop video recording.

### Clarity Zoom

During recording and preview, double-tap the screen or tap the zoom button on the right of the screen to zoom in or out without compromising image quality.

\*Supports 4K60fps and below in Video Mode, and 30fps and below in PureVideo.

### Cancel Recording

In camera settings, turn on Cancel Recording. You can then long press the Shutter Button to instantly cancel the current recording and start again.

## Pause Recording

Pause and resume recording in the same file. There are three ways to use this feature:

Camera Status	Operations
Recording	<p>Tap the red button at the bottom center of the screen to pause the recording for the first time.</p> <p>To resume or pause your recording again, tap the button or press the Shutter Button once.</p> <p>Click the red button at the bottom right of the screen to save your footage to the camera's album.</p>
Turning off (while video recording is paused)	<p>You can continue to record in the same file the next time you turn on the camera.</p> <p>Tap the red button at the bottom of the screen and turn off your camera. Turn the camera back on and continue to record/pause recording in the same way as normal.</p> <p>Click the red button at the bottom right corner to save your clip to an album.</p>
On Album Page	<p>Click the red button in the lower right corner of the album to continue recording in that file.</p>

## Photo Grab

Take a high quality photo even when you're recording a video in 4K60fps or below in Video and FreeFrame Video mode. All parameters are supported.

Tap the circle button in the bottom left corner to take a HD photo whilst recording.

After recording, the video and photo will both be saved.

## Auto Dash

In camera settings, tap "Power Off Charging Settings" and choose "Charge and Record". You can adjust the shooting settings and mode here. When the camera is connected to an external power source, it will automatically power on and start shooting in the set shooting mode and parameters.

This function is ideal for cars or motorcycles as it acts as a dashcam.

Once the camera is disconnected from the power source, the camera will automatically stop recording, save the file and start counting down to power off.

## AI Warp

Add a dynamic twist to your videos with AI Warp. Search for a filter in the app and apply premium AI effects to the whole clip or specific parts.

## AI Selfie Stick Eraser

Choose the AI Selfie Stick Eraser effect in Shot Lab for epic third-person perspectives. If you have used the selfie stick in your video, AI will automatically detect and remove it from your clips.

## Motion ND

By adding Motion ND directly to the image in the app, you can create visual blockbusters with a cinematic sense of speed even without an ND filter. Ideal for shots in the forward direction while riding or driving.

## AI Highlights Assistant

You can use this feature on the camera or in the app.

### In-Camera:

Swipe down from the top of the touchscreen and enable AI Highlights Assistant.

Go to the Album Page to view the footage after recording.

AI will automatically analyze a single video and show you the highlights to review.

Choose the highlight clips and save them separately or merge them into one video.

You can then delete the rest to quickly free up storage space.

### In the app:

Once the camera is connected to the app, go to the album page and open your clip. Pause the video and you can see your highlights in the 'Highlights' section.

You can edit the clip duration and choose the highlights you want to export, or make more clips.

In addition, AI will automatically create and edit a highlight reel for you.

You can also view them in the new Memories section of the app.

## app Background Downloading

You can now download your clips to the app as it runs in the background.

As they download, you can exit the app and keep using your phone until they're ready.

The app will notify you once the download is complete.

## GPS Preview Remote

Preview your footage in real-time and adjust camera settings with the GPS Preview Remote. Record precise GPS information and other data to add to your footage in post.

### Overview

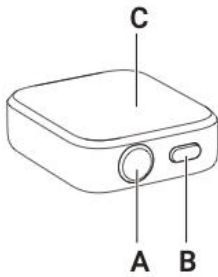

A. Shutter Button

B. Power Button

C. Touch Screen

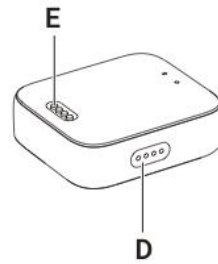

D. Speaker

E. Charging Points

### Charging

1. Put the remote on the charging base, ensuring that the charging points are in full contact.
2. Then, connect the charging base to the charger and the power supply. An indicator will appear on the touch screen to confirm the remote is charging.

Note:

- Please use a 5V/1.5A power adapter to charge the Remote.
- Keep the remote and the charging base clean and dry.

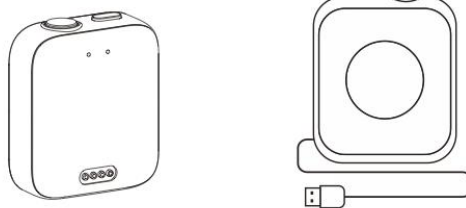

**Install**

You can attach the GPS Preview Remote in three ways. It has two straps for flexible mounting.

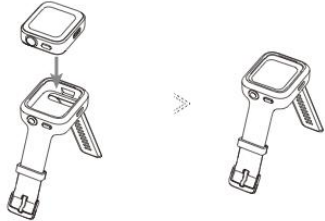
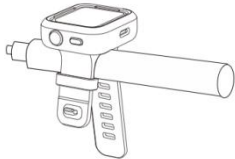
Position	Description	Figure
On wrist	Use the Wrist Strap to wear the GPS Preview Remote on your wrist. Ensure the buttons are aligned correctly.	
On selfie stick	Use the Universal Strap to attach the remote to a selfie stick. Ensure the buttons are aligned correctly.	
On bike/motorcycle	Use the Universal Strap to attach the remote to the handlebars. Ensure the buttons are aligned correctly.	

## How to Use

### Power on/off

Remote Status	Operation	Descriptions
Powered off	Long press Power Button	<ul style="list-style-type: none"> <li>Power on the remote.</li> </ul>
Powered on (camera disconnected)	Long press Power Button	<ul style="list-style-type: none"> <li>Power off the remote.</li> </ul>
Powered on (camera connected)	Long press Power Button	<ul style="list-style-type: none"> <li>Power the remote/the camera/both (you can select this function).</li> </ul>

### Connecting the Camera

1. Long press the Power Button to turn on the remote.
2. Power on the camera.
3. Click "Insta360 GPS Preview Remote" on the camera's Bluetooth Remote interface. When the camera's screen displays Connected, it has been paired successfully.

#### Notes:

- For the best experience, update your camera's firmware to the latest official version.
- The optimal range for live preview is up to 26.2ft (8m) and 65.6ft (20m) for remote control, measured in an open environment without interference.
- Please pay attention to the Insta360 official website for future camera compatibility and firmware updates.
- After connecting to the remote for the first time, the device can wake up the camera within range without pairing.



### Connecting Multiple Cameras

Swipe down from the top of the remote's watch dial to enter the connecting interface and tap the camera button. The remote will be ready to pair. Enter the Bluetooth Remote feature on your camera and connect to the remote. Repeat the process as needed.

#### Notes:

- The remote can control up to four cameras at a time. Each camera only recognizes one remote at a time.
- The remote will only show the number of connected cameras and no other camera information.

### Wake up a Camera

You can use the remote to wake up your camera. After connecting to the camera for the first time, swipe down on the remote touchscreen to enter the connection interface, and choose one of the following two ways to wake up the camera:

- **Connect:** Wake up the last connected camera. The camera will automatically connect to the remote once powered on.
- **QuickCapture:** Wake up the last connected camera. The camera will automatically connect to the remote and enter QuickCapture.

#### Notes:

- Enable "Bluetooth Wakeup" on the camera to use this feature.
- The feature must be set on the camera before waking up, even if the remote is connected.
- To use QuickCapture, make sure it is enabled on your camera.
- Press the remote's Shutter Button once to enter QuickCapture. Long press the Shutter Button to connect to the camera.

## Control the Camera

When the camera is connected, use the remote's touchscreen or press its buttons to control the camera.

## Preview Page

When the camera is connected, the remote will display the following camera information on the preview page:

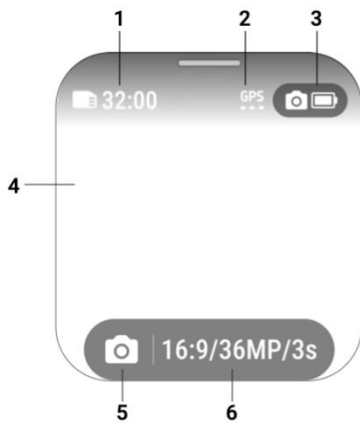

1. Camera Storage
2. GPS Signal
3. Camera Battery Status
4. Preview Page
5. Shooting Mode
6. Shooting Specifications

## Switch Shooting Modes

- Touchscreen: Swipe left or right on preview page to switch shooting mode.
- Power Button: Press repeatedly to switch shooting modes.

## Shooting Specifications

On the preview page, tap the shooting specifications button or swipe from the bottom upwards to enter and adjust shooting specifications.

## Shooting Parameters

On the preview page, swipe right to left to enter and adjust shooting parameters.

**Take Photos or Videos**

Remote Status	Operation	Descriptions
On the preview page	Press the Shutter Button	<ul style="list-style-type: none"> <li>• Take a photo/start recording a video.</li> </ul>
Recording	Press the Shutter Button	<ul style="list-style-type: none"> <li>• Stop recording.</li> </ul>

**application Center**

**Dashboard and Compass**

Swipe left or right on the remote's watch dial screen to enter Dashboard, Compass or Settings.

**Settings**

You will find the following in Settings: Display and Brightness, Direction of Display, Sound, Time, Language, About and Factory Data Reset.

**Firmware Update**

Open the Insta360 App > Settings > Update GPS Remote Control. Search and connect to the remote.

Once connected, the app will prompt you to update if there is a new firmware version.

Please follow the on-screen instructions to update the remote's firmware.

## File Transfer

Connect Ace Pro to a mobile phone or computer with the included Type-C cable for file transfer. You can download Ace Pro's files to your phone or PC, then use the Insta360 App or Insta360 Studio to edit and export.

Connect Ace Pro to a mobile phone or computer with the included Type-C cable for file transfer. You can download Ace Pro's files to your phone or PC, then use the Insta360 App or Insta360 Studio to edit and export.

### Download files from Ace Pro to the Insta360 App

1. Connect Ace Pro to your phone via the Insta360 App.
2. Enter the Album page, then select Camera.
3. Tap the multi-select icon in the upper right corner of the page and select the files you want to download. Tap the download icon in the bottom right corner to download. You can use other apps or lock your phone as you wait for footage to download to the app.

### Download files from Ace Pro to your computer

1. Connect Ace Pro to your PC via the official cable.
2. Open the DCIM > Camera01 folder, then copy the photos/videos you want to your PC.

## Transfer files between the Insta360 App and your Windows computer

### iPhone

1. Install iTunes on your PC. Connect your iPhone to your PC, open iTunes, then complete the authorization process according to the instructions.
2. After successful authorization, click the iPhone icon in the top left corner, and the iPhone's files will appear.
3. Click "File Sharing" and choose "Insta360" from the list. Then do one of the following:
  - Transfer from iPhone to Windows PC: Find the DCIM folder, then click Save. Choose your desired path and click Save.
  - Transfer from Windows PC to iPhone: Create a new folder and name it IMPORT, then copy the photos/videos to the IMPORT folder. Replace the IMPORT folder in the Insta360 App.

### Android

1. Connect your Android phone to your PC, then choose "Manage Files" under "USB Connected" on the phone.
2. Click "My Computer/This Computer", find your phone model, and click "Internal Storage".
3. Find `"/Android/data/com.arashivision.insta360akiko > files > Insta360OneR > galleryOriginal"`, then do one of the following:
  - Transfer from Android to Windows PC: Copy the folder or files to your PC.
  - Transfer from Windows PC to Android: Copy files to this folder from your PC.

## Transfer files between the Insta360 App and your Mac

### iPhone

1. Connect iPhone to your Mac.
2. In the Finder window on your Mac, select your iPhone.
3. At the top of the Finder window, click Files, then do one of the following:
  - Transfer from Mac to iPhone: Drag a file or a selection of files from your Mac onto the Insta360 App in the list.
  - Transfer from iPhone to Mac: Click the small triangle beside the Insta360 App to see its files on your iPhone, then drag the desired files to a folder on your Mac.

### Android

1. Install Android File Transfer on your Mac.
2. Connect your Android phone to Mac.
3. Open Android File Transfer.
4. Browse the files and folders on your Android device, then copy and paste them to a folder on your Mac.

## Insta360 App

### Connect to the Insta360 App

1. Download the Insta360 App . Alternatively, search "Insta360" in any major app store or scan the QR code on the box.
2. Press the Power Button to turn on Ace Pro.
3. Enable Wi-Fi and Bluetooth on your smartphone.
4. Open the Insta360 App and click the camera icon at the bottom of the page. Follow the on-screen instructions to activate your camera.
5. If you connect to the Insta360 App for the first time, you need to authorize the connection on the touchscreen.

If you are unable to connect to the app, go to your smartphone's Wi-Fi settings, find your Ace Pro, enter the password and return to the app.

**Note:** You can change the camera's Wi-Fi password on the app settings page.

### Still can't connect to the Insta360 App?

1. Check if the Insta360 App has permission to access the following: network permission, Bluetooth permission, or local network permission.
2. Check if the Wi-Fi option is enabled and turned on on your camera.
3. Make sure Ace Pro is close enough to the phone.

### Android Mode

1. Connect Ace Pro to your Android phone with the USB-C cable.
2. A notification for Android Mode will pop up.
3. Open the Insta360 App to control the camera and access the camera's footage.

### app Interface

Enter the shooting interface of the app and you will see the following icon functions. Some of the icon functions are only available in some shooting modes.

## Maintenance

### Firmware Update

Firmware updates will be regularly available for Ace Pro to ensure it runs efficiently. Please update to the latest version for optimal results.

*Before updating, ensure Ace Pro has at least 20% battery remaining.*

#### Update via Insta360 App:

Connect Ace Pro to the Insta360 App. The app will notify you if there is a new firmware update available. Follow the on-screen instructions to update the firmware.

**If the camera firmware update fails, check the following and try the update again:**

1. Ensure the camera is close to your phone.
2. Keep the Insta360 App running and do not exit or minimize it.
3. Ensure your phone has a strong and stable network connection.

#### Update via Computer

1. Make sure Ace Pro is powered on.
2. Connect the camera to the computer using the USB Type-C cable and select USB Mode.
3. Download the latest firmware version from the official Insta360 website on your computer.
4. Once the computer has recognized Ace Pro, copy the "Insta360AceProFW.bin" file to Ace Pro's root directory.

**Note:** Do not change the file name.

5. Disconnect Ace Pro from the computer. Ace Pro will automatically power off. The Indicator Lights will slowly flash blue.
6. Ace Pro will automatically restart once the update is complete.



## Waterproofing

1. Insta360 Ace Pro camera is waterproof up to 33ft (10m) without a Dive Case. For extended underwater use, use the Dive Case. The Dive Case is waterproof to 96ft (60m).
2. Check that the battery compartment is free from dirt or foreign objects. Once the battery is inserted, close the Battery Cover and ensure the yellow indication mark is completely covered to ensure waterproofing is not affected.
3. Ensure the USB Port Cover is free from dirt or foreign objects. Ensure it is completely closed before using the camera underwater.
4. After every use in seawater, soak the camera in fresh water for 15 minutes, gently rinse it with the flip screen open, and then dry it thoroughly with a soft cloth. Wait until it is completely dry before using it again.

### To maintain the waterproofing of Ace Pro:

- Do not use a hair dryer to dry the camera, as it may affect the microphone and speaker and damage the internal waterproofing ability.
- Avoid operating the camera for extended periods (>1 hour) outside the recommended temperature range (-4°F to 104°F/-20°C to 40°C) or in humid environments.
- Do not store the camera in high-temperature or high-humidity environments.
- Do not disassemble the camera.
- Avoid entering water at high speeds. Excessive water impact may damage the device.
- Ensure the camera's Battery Cover, USB Port Cover and Lens Cover are installed and securely closed, or the camera will not be waterproof.

## Cleaning

1. If there are foreign objects, such as dirt or hair, on the Lens Cover, clean it with clean water or use a lens pen, air blower or cloth.
2. If there are foreign objects, such as dirt or hair, on the lens, use a lens pen, air blower or cloth to clean it.
3. Ensure the Battery and Battery Cover is free of dirt and foreign objects like sand or hair. Clean it with a soft, dry cloth or paper if necessary.
4. Ensure the MicroSD Card Slot is free of dust, dirt and sand to ensure the camera works properly.

## Battery Precautions

- Only use batteries provided by Insta360 designed for Ace Pro. Insta360 is not responsible for any accidents or failures that occur by using unofficial batteries. If you need to replace the battery, please purchase it from the Insta360 official store.
- Avoid using the battery outside the recommended temperature range (-4°F to 104°F/-20°C to 40°C). Temperatures outside of this may cause the battery to expand, catch fire or even explode. Before using the camera in a low-temperature environment, fully charge the battery in a regular-temperature environment first to extend the battery life.
- If the battery is not used for a long time, its performance will be affected.
- Recharge and discharge the battery every three months to maintain optimal working conditions.

**Arashi Vision Inc.**

ADD: 11th Floor, Building 2, Jinlitong Financial Center, Bao'an District, Shenzhen, Guangdong, China

WEB: [www.insta360.com](http://www.insta360.com)

TEL: 400-833-4360 +1 800 6920 360

EMAIL: [service@insta360.com](mailto:service@insta360.com)

V1.0