

Full Color  
Night Vision

**imou**  
Enjoy Smart Life

EN

DE

ES

FR

IT

NL

PT

# Quick Start Guide

Bullet 2S  
Bullet 2S 4MP

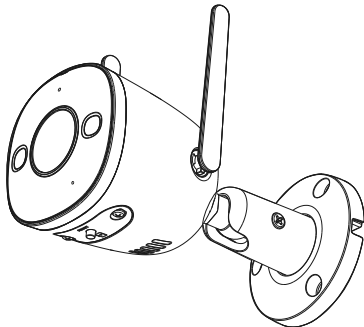

[www.imoulife.com](http://www.imoulife.com)

# Welcome

Thank you for choosing IMOU.

We are devoted to providing you easy smart home products. If you have problems using the product, please contact our service team before returning your product.

Our service mail: [service.global@imoulife.com](mailto:service.global@imoulife.com)

Frequently asked questions can be found at [imoulife.com/support/help](http://imoulife.com/support/help)



## Package content



Camera x1



Positioning Map x1



Waterproof Connector x1



Screw Package x1



Quick Start Guide x1

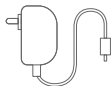

Power Adapter x1

## Camera introduction

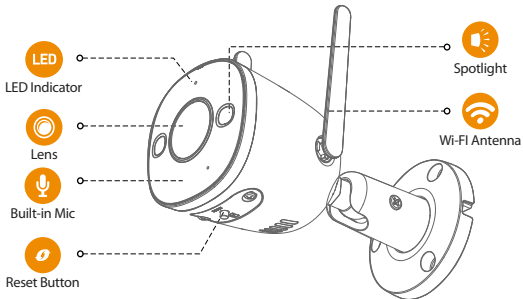

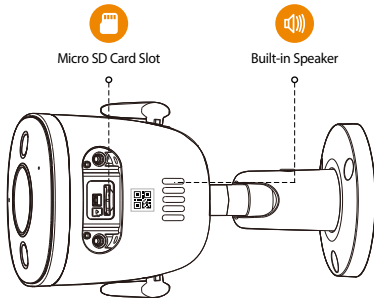

**The pattern of the LED indicator is included in the following table.**

LED Status	Device Status
Off	<ul style="list-style-type: none"> <li>● Powered off/LED turned off</li> <li>● Rebooting after reset</li> </ul>
Red light on	<ul style="list-style-type: none"> <li>● Booting</li> <li>● Device malfunction</li> </ul>
Green light flashing	<ul style="list-style-type: none"> <li>● Waiting for network</li> </ul>
Green light on	<ul style="list-style-type: none"> <li>● Operating properly</li> </ul>
Red light flashing	<ul style="list-style-type: none"> <li>● Network connection failed</li> </ul>
Green and red light flashing alternately	<ul style="list-style-type: none"> <li>● Firmware updating</li> </ul>

1

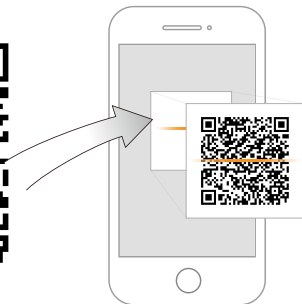

Imou Life



## i Tips



To ensure the best possible wireless performance, please make sure there are no obstacles and electromagnetic interference between the camera and router.

2

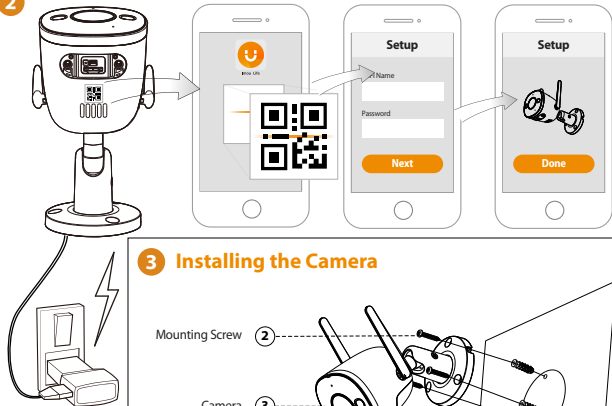

### 3 Installing the Camera

Mounting Screw ②

Camera ③

Wall Anchor ①

Positioning Map ○

Mounting Surface ○

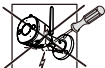
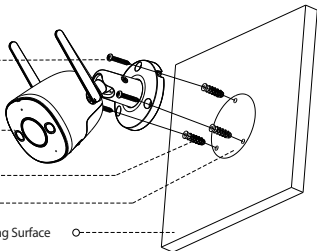

DC  
12V1A

<b>Problem</b>	<b>Solution</b>
The APP says "Failed to configure device network"	<ul style="list-style-type: none"> <li>• Reset your Camera and connect it again.</li> <li>• Some cameras only support 2.4GHz, while some routers have dual band, 2.4G/5G. Make sure you are connecting 2.4GHz only.</li> </ul>
No audio	<ul style="list-style-type: none"> <li>• Ensure audio function on camera is turned on.</li> <li>• Ensure audio is turned up on viewing device.</li> </ul>
Human detection not working	<ul style="list-style-type: none"> <li>• Ensure you have enabled "Human Detection" in the Device Settings screen of the Imou LifeApp.</li> </ul>
The device cannot work normally or start?	<ul style="list-style-type: none"> <li>• Check the LED indicator status. If the light is not in green, press and hold the reset button for 10 s to reset the the camera.</li> </ul>
How to connect the camera to a new Wi-Fi?	<ul style="list-style-type: none"> <li>• If the camera is offline, reset the camera, and the configure the camera again.</li> </ul>
Connection is overtime?	<ul style="list-style-type: none"> <li>• Check if the distance between the camera and the router, the camera and the smart phone is within 5 m (16.4 ft) during the connection.</li> </ul>
When the Micro SD card is full, how is the recorded video saved?	<ul style="list-style-type: none"> <li>• When the Micro SD card is full, the system will overwrite the previous recorded videos. Save the important information in time.</li> </ul>
The device is offline?	<p>Check the indicator status:</p> <ul style="list-style-type: none"> <li>• If the green light is on, check whether the router can connect to the Internet. If Internet is working, restartthe camera.</li> <li>• If the red light flashes, reset the camera, and then configure the camera again.</li> <li>• If the red light is on, it means the camera is faulty.</li> </ul>

# Quick Start Guide

Bullet 2S  
Bullet 2S 4MP

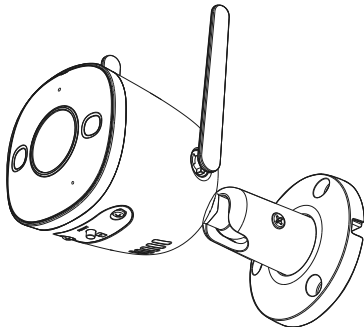



# Willkommen

Vielen Dank, dass Sie sich für IMOU entschieden haben. Wir sind bestrebt, einfachere Produkte für das intelligente Heim anzubieten. Wenn Sie Probleme bei der Verwendung des Produkts haben, wenden Sie sich bitte an unser Serviceteam.

Unsere Service-Mail lautet: [service.global@imoulife.com](mailto:service.global@imoulife.com)

Häufig gestellte Fragen finden Sie unter [imoulife.com/support/help](https://imoulife.com/support/help)



## Packungsinhalt

DE



Kamera x 1



Montageschablone x 1



Wasserdichter Anschluss x1



Schraubenbeutel x 1



Kurzanleitung x 1

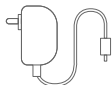

Netzteil x 1

## Einführung in die Kamera

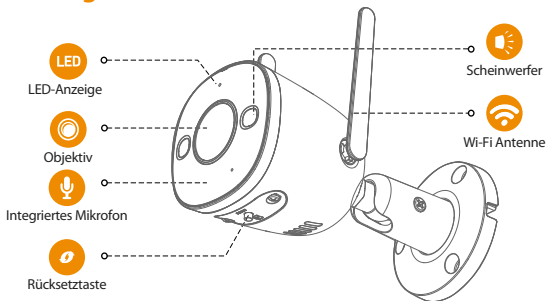

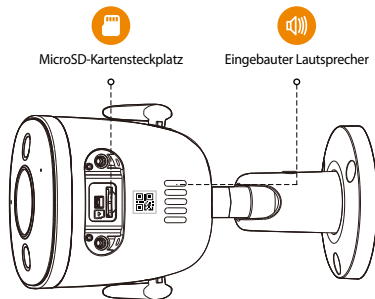

**Das Muster der LED-Anzeigen ist in der folgenden Tabelle aufgeführt.**

LED-Status/Gerätstatus	Device Status
AUS	<ul style="list-style-type: none"> <li>● Abgeschaltet/LED Ausgeschaltet</li> <li>● Gerät fährt nach Rücksetzung hoch</li> </ul>
Rote LED leuchtet	<ul style="list-style-type: none"> <li>● Gerät fährt hoch</li> <li>● Gerätestörung</li> </ul>
Grüne LED blinkt	<ul style="list-style-type: none"> <li>● Warten auf</li> </ul>
Grüne LED leuchtet	<ul style="list-style-type: none"> <li>● Ordnungsgemäßer Betrieb</li> </ul>
Rechte LED blinkt	<ul style="list-style-type: none"> <li>● Netzwerkverbindung fehlgeschlagen</li> </ul>
Grüne und rote LED blinken abwechselnd	<ul style="list-style-type: none"> <li>● Firmware-Update</li> </ul>

1

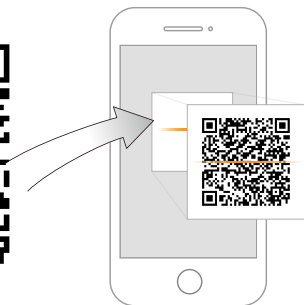

DE



Imou Life

Download on the  
App StoreGET IT ON  
Google play

Windows

## i Tips



Um die bestmögliche Funkübertragung zu gewährleisten, stellen Sie sicher, dass zwischen Kamera und Router keine Hindernisse und elektromagnetische Störungen vorhanden sind.



### 3 Kamerainstallieren

Selbstschneidende  
Schraube ②

Kamera ③

Dübel ①

Montageschablone

Montagefläche

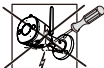
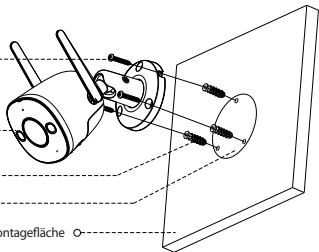

DC  
12V1A

Problem	Lösungen
Die App meldet: „Konfiguration des Gerätnetzes fehlgeschlagen“	<ul style="list-style-type: none"> <li>• Setzen Sie Ihre Kamera zurück und schließen Sie sie wieder an.</li> <li>• Einige Kameras unterstützen nur 2,4 GHz, während einige Router über Dualband mit 2,4 GHz/5 GHz verfügen. Stellen Sie sicher, dass Sie sie nur mit 2,4 GHz verbinden.</li> </ul>
Kein Ton	<ul style="list-style-type: none"> <li>• Stellen Sie sicher, dass der Kameraton eingeschaltet ist.</li> <li>• Stellen Sie sicher, dass der Ton am Anzeigergerät eingeschaltet ist.</li> </ul>
Personenerkennung funktioniert nicht	<ul style="list-style-type: none"> <li>• Vergewissern Sie sich, dass Sie „Personenerkennung“ in den Geräteeinstellungen der Imou Life-App aktiviert haben.</li> </ul>
Funktioniert oder startet das Gerät nicht ordnungsgemäß?	<ul style="list-style-type: none"> <li>• Überprüfen Sie die Status-LED. Wenn sie nicht grün leuchtet, halten Sie die Reset-Taste 10 Sekunden lang gedrückt, um die Kamera zurückzusetzen.</li> </ul>
Wie verbindet man die Kamera mit einem neuen WLAN?	<ul style="list-style-type: none"> <li>• Wenn die Kamera offline ist, setzen Sie sie zurück und konfigurieren Sie sie anschließend erneut.</li> </ul>
Was kann ich tun, wenn die Zeit der Verbindung abgelaufen ist?	<ul style="list-style-type: none"> <li>• Überprüfen Sie, ob der Abstand zwischen Kamera und Router und zwischen Kamera und Smartphone während des Verbindungsversuchs jeweils maximal 5 m beträgt.</li> </ul>
Wie wird die Videoaufzeichnung gespeichert, wenn die microSD-Karte voll ist?	<ul style="list-style-type: none"> <li>• Wenn die microSD-Karte voll ist, überschreibt das System früher aufgezeichnete Videos. Speichern Sie wichtige Informationen rechtzeitig.</li> </ul>
Das Gerät ist offline?	<p>Überprüfen Sie die Status-LED:</p> <ul style="list-style-type: none"> <li>• Wenn die grüne LED leuchtet, prüfen Sie, ob der Router eine Verbindung zum Internet herstellen kann. Wenn der Internetzugang funktioniert, starten Sie die Kamera neu.</li> <li>• Wenn die rote LED blinkt, setzen Sie die Kamera zurück und konfigurieren Sie sie erneut.</li> <li>• Wenn die rote LED leuchtet, bedeutet dies, dass die Kamera defekt ist.</li> </ul>

# Quick Start Guide

Bullet 2S  
Bullet 2S 4MP

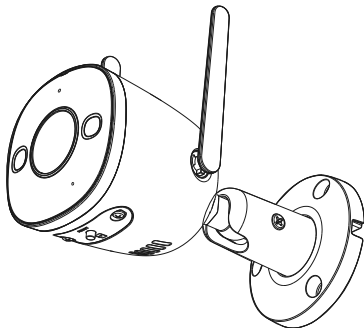

# Bienvenido

Gracias por elegir IMOU

Nuestra misión es proporcionar productos fáciles de usar para un hogar inteligente. Si tiene problemas usando el producto, por favor diríjase a nuestro equipo de atención al cliente antes de devolver su producto.

Nuestro correo electrónico de servicio:

[service.global@imoulife.com](mailto:service.global@imoulife.com)

Nos comprometemos a contestarle en 24 horas.

Puede encontrar respuesta a las preguntas más frecuentes en [imoulife.com/support/help](https://imoulife.com/support/help)

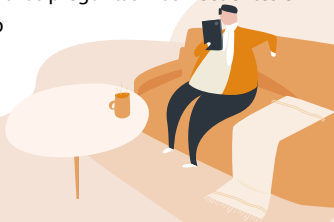



## Contenido del paquete



Cámara x 1



Mapa de  
posicionamiento x 1



Conector a prueba  
de agua x 1



Juego de tornillos x 1



Guía de inicio rápido x 1

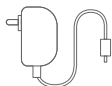

Alimentador x 1

ES

## Introducción a la cámara

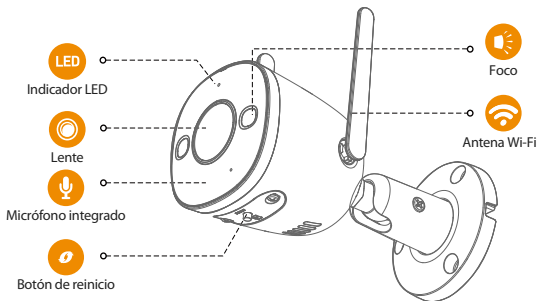

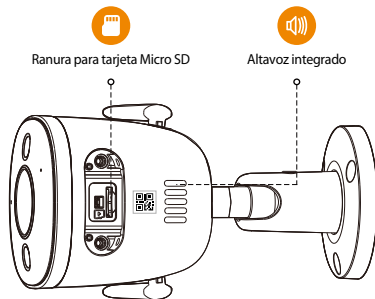

**El patrón de los indicadores LED se incluye en la siguiente tabla.**

Estado LED	Estado del aparato
APAGADA	<ul style="list-style-type: none"> <li>● Apagada/LED apagada</li> <li>● Nuevo arranque después del reinicio</li> </ul>
Luz roja encendida	<ul style="list-style-type: none"> <li>● Arranque</li> <li>● Avería del dispositivo</li> </ul>
Luz verde parpadeante	<ul style="list-style-type: none"> <li>● En espera de la red</li> </ul>
Luz verde encendida	<ul style="list-style-type: none"> <li>● Funcionando correctamente</li> </ul>
Luz derecha parpadeante	<ul style="list-style-type: none"> <li>● Fallo de conexión de red</li> </ul>
Luz verde y luz roja parpadeando alternativamente	<ul style="list-style-type: none"> <li>● Actualización de firmware</li> </ul>

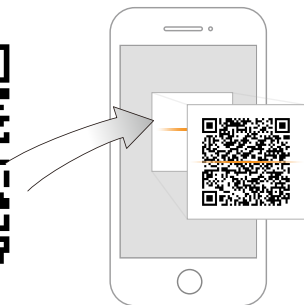
**Imou Life**Download on the  
App StoreGET IT ON  
Google play

Windows

## Consejos



Para garantizar el mejor rendimiento inalámbrico posible, por favor asegúrese de que no hay obstáculos ni interferencias electromagnéticas entre la cámara y el enrutador.

2



### 3 Instalación de la cámara

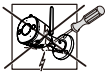
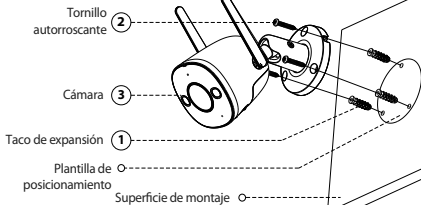

DC  
12V1A

## Solución de problemas

Problema	Solución
La aplicación indica «Fallo al configurar la red del dispositivo»	<ul style="list-style-type: none"><li>• Reinicie su cámara y conéctela de nuevo.</li><li>• Algunas cámaras solo soportan 2,4 GHz, mientras que algunos routers tienen banda dual, 2.4G/5G. Compruebe que solo conecta a 2,4 GHz.</li></ul>
No hay sonido	<ul style="list-style-type: none"><li>• Compruebe que la función de sonido de la cámara esté encendida.</li><li>• Compruebe que el sonido en el dispositivo de visualización esté alto.</li></ul>
No funciona la detección de personas	<ul style="list-style-type: none"><li>• Compruebe que esté activada la «detección de personas» en la pantalla de configuración del dispositivo en la aplicación Imou Life.</li></ul>
¿El dispositivo no funciona o se inicia con normalidad?	<ul style="list-style-type: none"><li>• Verifique el estado del indicador LED. Si el LED no se ilumina en verde, mantenga pulsado el botón de reinicio durante 10 segundos para reiniciar la cámara.</li></ul>
¿Cómo conectar la cámara a una nueva red Wi-Fi?	<ul style="list-style-type: none"><li>• Si la cámara está fuera de línea, restablézcala y vuelva a configurarla.</li></ul>
¿La conexión se ha agotado?	<ul style="list-style-type: none"><li>• Compruebe si la distancia entre la cámara y el enrutador, y entre la cámara y el teléfono inteligente es menor que 5 m (16,4 pies) durante la conexión.</li></ul>
Cuando la tarjeta microSD está llena, ¿cómo se guardan los videos grabados?	<ul style="list-style-type: none"><li>• Cuando la tarjeta microSD esté llena, el sistema sobrescribirá los videos grabados con anterioridad. Guarde la información importante oportunamente.</li></ul>
¿El dispositivo no tiene conexión a Internet?	Verifique el estado del indicador: <ul style="list-style-type: none"><li>• Si la luz verde está encendida, verifique si el router puede conectarse a Internet. Si la conexión a Internet funciona, reinicie la cámara.</li><li>• Si la luz roja parpadea, reinicie la cámara y vuelva a configurarla.</li><li>• Si la luz roja está encendida, quiere que la cámara está defectuosa.</li></ul>

**imou**

Enjoy Smart Life

FR

# Quick Start Guide

Bullet 2S  
Bullet 2S 4MP

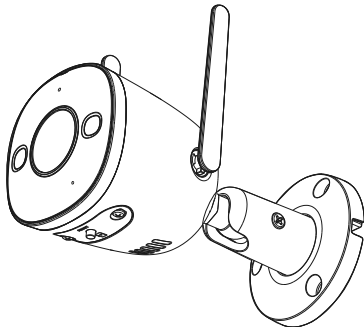

[www.imoulife.com](http://www.imoulife.com)

# Bienvenue

FR

Merci d'avoir choisi IMOU.

Nous nous consacrons à fournir des produits pour la maison intelligente plus faciles à utiliser. Si vous rencontrez des difficultés lors de l'utilisation du produit, veuillez contacter notre équipe technique avant de renvoyer votre produit.

Notre courriel de service : [service.global@imoulife.com](mailto:service.global@imoulife.com)

Nous nous engageons à vous répondre dans les 24 heures.

Les questions les plus fréquemment posées peuvent être consultées sur le site [imoulife.com/support/help](https://imoulife.com/support/help)



## Contenu de l'emballage



Caméra x 1



Schéma de  
positionnement x 1



Connecteur étanche x1



Jeu de vis x 1



Guide de démarrage  
rapide x 1

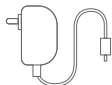

Adaptateur d'alimentation x 1

## Introduction à la caméra

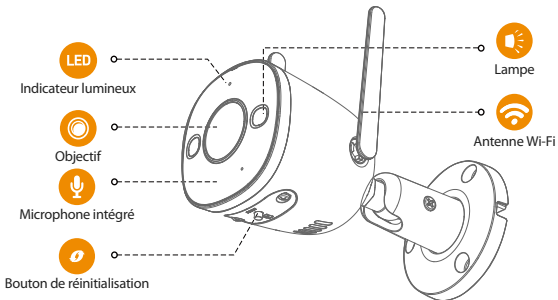



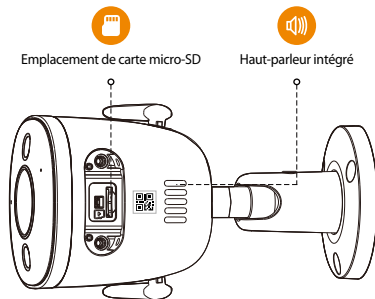

**Le schéma des voyants est inclus dans le tableau suivant.**

Statut du voyant	État de l'appareil
ARRÊT	<ul style="list-style-type: none"> <li>● Éteint/Voyant éteint</li> <li>● Redémarrage après remise à zéro</li> </ul>
Allumé en rouge	<ul style="list-style-type: none"> <li>● Amorçage</li> <li>● Fonctionnement défectueux de l'appareil</li> </ul>
Clignotant en vert	<ul style="list-style-type: none"> <li>● En attente de connexion réseau</li> </ul>
Allumé en vert	<ul style="list-style-type: none"> <li>● Fonctionnement normal</li> </ul>
Clignotement du voyant droit	<ul style="list-style-type: none"> <li>● Échec de connexion au réseau</li> </ul>
Voyant vert et voyant rouge clignotant en alternance	<ul style="list-style-type: none"> <li>● Mise à jour du micrologiciel</li> </ul>

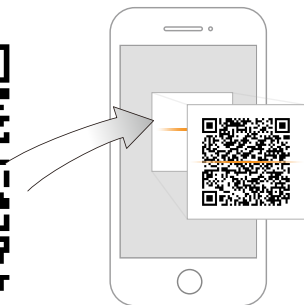

Imou Life



## Conseils



Pour garantir les meilleures performances sans fil possible, veuillez vous assurer qu'il n'y a pas d'obstacles ni d'interférences électromagnétiques entre la caméra et le routeur.

2

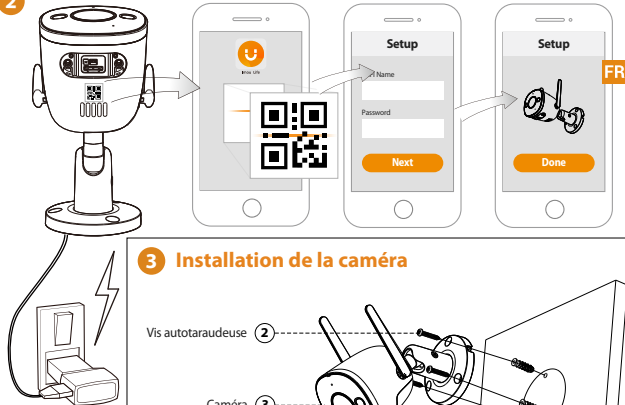

### 3 Installation de la caméra

Vis autotaraudeuse ②

Caméra ③

Cheville à expansion ①

Patron d'installation ○

Surface de montage ○

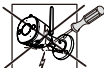
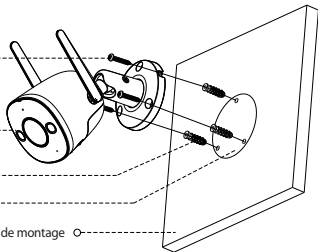

DC  
12V1A

## Dépannage

<b>Problème</b>	<b>Solution</b>
L'APP indique « Échec de la configuration du réseau de l'appareil »	<ul style="list-style-type: none"><li>• Réinitialisez votre caméra et rebranchez-la.</li><li>• Certaines caméras ne prennent en charge que la bande 2,4 GHz, tandis que certains routeurs ont une double bande, 2,4 GHz/5 GHz. Assurez-vous de ne vous connecter que sur la bande 2,4 GHz.</li></ul>
Pas de son	<ul style="list-style-type: none"><li>• Assurez-vous que la fonction audio de la caméra est activée.</li><li>• Assurez-vous que le son est allumé sur l'appareil de visualisation.</li></ul>
La détection humaine ne fonctionne pas	<ul style="list-style-type: none"><li>• Assurez-vous d'avoir activé la « Détection humaine » dans l'écran des paramètres de l'appareil de l'application Imou Life.</li></ul>
L'appareil ne fonctionne pas normalement ou ne démarre pas ?	<ul style="list-style-type: none"><li>• Vérifiez l'état de l'indicateur lumineux. Si le voyant n'est pas vert, maintenez le bouton de réinitialisation enfoncé pendant 10 s pour réinitialiser la caméra.</li></ul>
Comment connecter la caméra à un nouveau Wi-Fi ?	<ul style="list-style-type: none"><li>• Si la caméra est hors ligne, réinitialisez la caméra et configurez à nouveau la caméra.</li></ul>
Délai de connexion dépassé ?	<ul style="list-style-type: none"><li>• Vérifiez si la distance entre la caméra et le routeur, la caméra et le Smartphone est inférieure à 5 m (16,4 pieds) pendant la phase de connexion.</li></ul>
Lorsque la carte microSD est pleine, comment la vidéo enregistrée est-elle sauvegardée ?	<ul style="list-style-type: none"><li>• Lorsque la carte microSD est pleine, le système écrase les vidéos enregistrées précédentes. Enregistrez les informations importantes à temps.</li></ul>
L'appareil est-il hors ligne ?	<p>Vérifiez l'état de l'indicateur lumineux:</p> <ul style="list-style-type: none"><li>• Si le voyant vert est allumé, vérifiez si le routeur peut se connecter à Internet. Si Internet fonctionne, redémarrez la caméra.</li><li>• Si le voyant rouge clignote, réinitialisez la caméra et configurez-la à nouveau.</li><li>• Si le voyant rouge est allumé, cela signifie que la caméra est défectueuse.</li></ul>

**imou**

Enjoy Smart Life

# Quick Start Guide

Bullet 2S  
Bullet 2S 4MP

IT

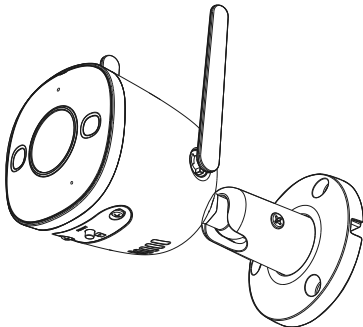

[www.imoulife.com](http://www.imoulife.com)

# Benvenuti

IT

Grazie per aver scelto IMOU.

Il nostro obiettivo è quello di fornire prodotti per la domotica più facili da utilizzare. In caso di problemi durante l'utilizzo del prodotto, si prega di contattare il nostro team di assistenza prima di restituire il prodotto.

La nostra e-mail per il servizio di assistenza: [service.global@imoulife.com](mailto:service.global@imoulife.com)

Promettiamo di rispondere entro 24 ore.

Le risposte alle domande più frequenti sono disponibili all'indirizzo [imoulife.com/support/help](https://imoulife.com/support/help)



## Contenuto della confezione



Telecamera x 1



Schema di  
posizionamento x 1

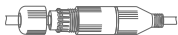

Connettore impermeabile x 1

IT



Confezione di viti x 1



QSG x 1

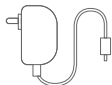

Alimentatore x 1

## Introduzione alla telecamera

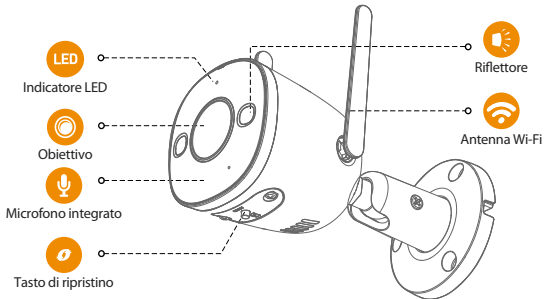

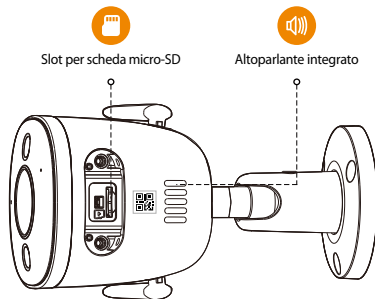

**Gli indicatori LED sono descritti nella tabella seguente.**

Stato LED	Stato dispositivo
SPENTO	<ul style="list-style-type: none"> <li>● Spento/LED spento</li> <li>● Riavvio dopo il ripristino</li> </ul>
Luce rossa accesa	<ul style="list-style-type: none"> <li>● Avvio</li> <li>● Malfunzionamento del dispositivo</li> </ul>
Luce verde lampeggiante	<ul style="list-style-type: none"> <li>● In attesa di rete</li> </ul>
Luce verde accesa	<ul style="list-style-type: none"> <li>● Funzionamento normale</li> </ul>
Luce rossa lampeggiante	<ul style="list-style-type: none"> <li>● Connessione di rete non riuscita</li> </ul>
La luce verde e quella rossa lampeggiano in alternanza	<ul style="list-style-type: none"> <li>● Aggiornamento del firmware</li> </ul>



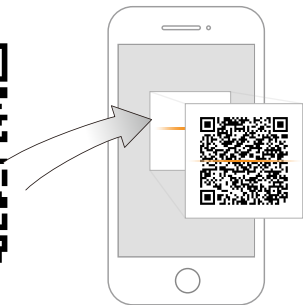

IT



Imou Life



Download on the  
App Store



GET IT ON  
Google play



Windows

## Suggerimenti



Per garantire le migliori prestazioni wireless possibili, assicurarsi che non ci siano ostacoli e interferenze elettromagnetiche tra la telecamera e il router.

2



### 3 Installazione della telecamera

Vite autofilettante ②

Telecamera ③

Bullone di espansione ①

Dima di posizionamento

Superficie di montaggio

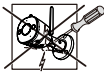
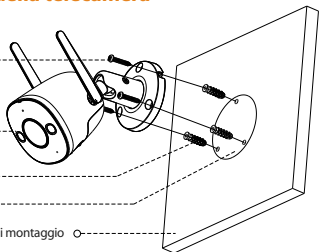

DC  
12V1A

## Risoluzione dei problemi

<b>Problema</b>	<b>Soluzione</b>
L'app mostra il messaggio "Impossibile configurare la rete del dispositivo"	<ul style="list-style-type: none"><li>• Resettare la telecamera e collegarla di nuovo.</li><li>• Alcune telecamere supportano solo la frequenza 2,4 GHz, mentre alcuni router sono a doppia banda (2,4/5 GHz). Accertarsi di utilizzare solo la connessione da 2,4 GHz.</li></ul>
Non c'è suono	<ul style="list-style-type: none"><li>• Accertarsi che la funzione audio della telecamera sia attiva.</li><li>• Accertarsi che l'audio del dispositivo ricevente sia acceso.</li></ul>
Il rilevamento persone non funziona	<ul style="list-style-type: none"><li>• Accertarsi di aver abilitato la funzione "Rilevamento persone" nella schermata Impostazioni dispositivo dell'app Imou Life.</li></ul>
Il dispositivo non si avvia o non funziona correttamente?	<ul style="list-style-type: none"><li>• Controllare il LED luminoso indicatore di stato. Se la luce non è verde, tenere premuto il pulsante di reset per 10 secondi per ripristinare la telecamera.</li></ul>
Come collegare la telecamera a una nuova rete Wi-Fi?	<ul style="list-style-type: none"><li>• Se la telecamera è offline, reimpostare la telecamera e configurarla di nuovo.</li></ul>
La connessione ha superato il tempo massimo?	<ul style="list-style-type: none"><li>• Durante la connessione, verificare che la distanza tra la telecamera e il router e la telecamera e lo smartphone non superi i 5 metri (16,4 piedi).</li></ul>
Quando la scheda micro SD è piena, come vengono salvati i video registrati?	<ul style="list-style-type: none"><li>• Quando la scheda micro SD è piena, il sistema sovrascrive i video registrati in precedenza. Salvare i contenuti importanti in anticipo.</li></ul>
Il dispositivo è offline?	Controllare l'indicatore di stato: <ul style="list-style-type: none"><li>• Se l'indicatore verde è acceso, controllare se il router è collegato a internet. Se Internet funziona correttamente, riavviare la telecamera.</li><li>• Se l'indicatore luminoso rosso lampeggia, reimpostare la telecamera e configurarla di nuovo.</li><li>• Se l'indicatore luminoso rosso è acceso, la telecamera è guasta.</li></ul>

**imou**

Enjoy Smart Life

# Quick Start Guide

Bullet 2S  
Bullet 2S 4MP

NL

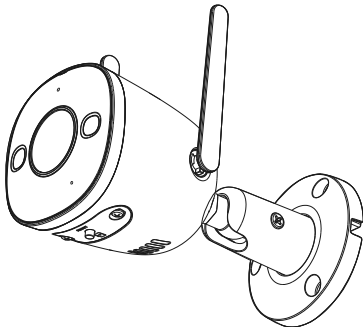

[www.imoulife.com](http://www.imoulife.com)

# Welkom

Bedankt dat u voor Imou heeft gekozen.

NL

Onze toewijding is om u eenvoudige Smart Home producten te bieden. Als u problemen ervaart met het gebruik van uw product, neem dan eerst contact op met onze service team: [service.global@imoulife.com](mailto:service.global@imoulife.com)

Gedetailleerde installatie-instructies en video's, veelgestelde vragen zijn te vinden op: [imoulife.com/support/help](https://imoulife.com/support/help)  
Of scan deze QR-code naar de helppagina.

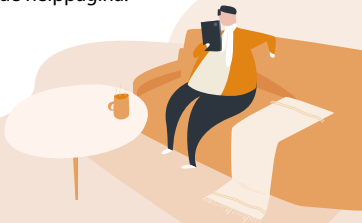

## Inhoud verpakking

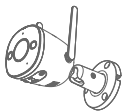

Camera x 1



Positioneringskaart x1



Waterdichte connector x1 **NL**



Schroevensetx1



QSG x1

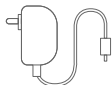

Voedingsadapter x1

## Introductie camera

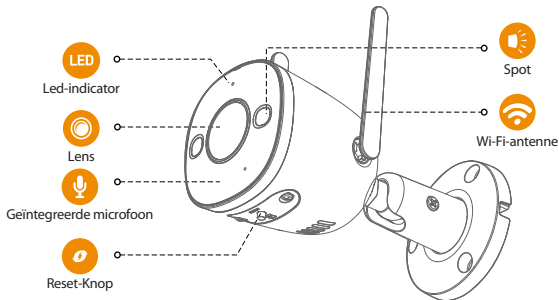

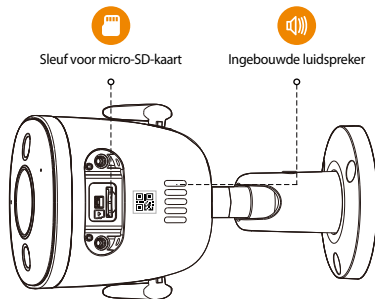

**Het patroon van led-indicatoren wordt weergegeven in de volgende tabel.**

Ledstatus	apparaatstatus
UIT	<ul style="list-style-type: none"> <li>● Uitgeschakeld/led uit</li> <li>● Opnieuw opstarten na reset</li> </ul>
Rood lampje aan	<ul style="list-style-type: none"> <li>● Bezig met opstarten</li> <li>● Storing van het apparaat</li> </ul>
Groen lampje knippert	<ul style="list-style-type: none"> <li>● Wachten op netwerk</li> </ul>
Groen lampje aan	<ul style="list-style-type: none"> <li>● Werkt zoals dat moet</li> </ul>
Rood lampje knippert	<ul style="list-style-type: none"> <li>● Netwerkverbinding mislukt</li> </ul>
Groen lampje en rood lampje knipperen afwisselend	<ul style="list-style-type: none"> <li>● Bijwerken firmware</li> </ul>

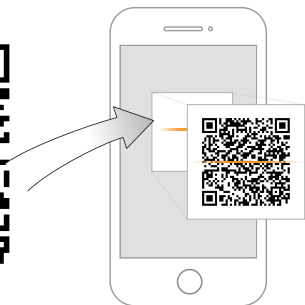

NL



## Tips

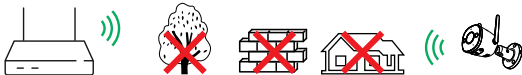

Zorg voor de best mogelijke draadloze prestatie dat er geen obstakels en elektromagnetische interferentie tussen de camera en router aanwezig zijn.



2

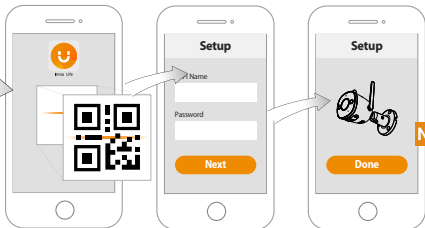
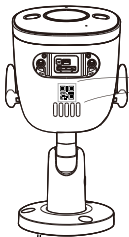

NL

### 3 Het installeren van de camera

Zelftappende schroef ②

Camera ③

Expansiebout ①

Montageoverzicht ○

Montage-oppervlak ○

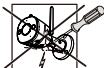
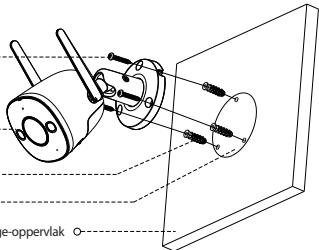

DC  
12V1A

## Probleemoplossing

<b>Probleem</b>	<b>Oplossing</b>
De app zegt "Instellen apparaatnetwerk mislukt"	<ul style="list-style-type: none"><li>• Reset uw camera en verbind deze opnieuw.</li><li>• Sommige camera's ondersteunen enkel 2,4 GHz, terwijl sommige routers een dubbele band hebben, namelijk 2,4 GHz en 5 GHz. Zorg ervoor dat u alleen verbinding maakt met de 2,4 GHz band.</li></ul>
Geen audio	<ul style="list-style-type: none"><li>• Zorg ervoor dat de audiofunctie op de camera is ingeschakeld.</li><li>• Zorg ervoor dat audio wordt ingeschakeld op het kijkapparaat.</li></ul>
Personendetectie werkt niet	<ul style="list-style-type: none"><li>• Zorg ervoor dat u "Personendetectie" hebt ingeschakeld in het scherm Apparaatinstellingen in de Imou Life-app.</li></ul>
Het apparaat werkt niet normaal of start niet?	<ul style="list-style-type: none"><li>• Controleer de led-indicatorstatus. Als het lampje niet groen brand, houdt u de resetknop 10 seconden ingedrukt om de camera te resetten.</li></ul>
Hoe kan ik de camera verbinden met een nieuw wifi?	<ul style="list-style-type: none"><li>• Als de camera offline is, reset u de camera en configureert u de camera opnieuw.</li></ul>
Duurt verbinden te lang?	<ul style="list-style-type: none"><li>• Controleer of de afstand tussen de camera en de router, de camera en de smartphone tijdens de verbinding binnen 5 m (16,4 ft) ligt.</li></ul>
Hoe wordt de opgenomen video's opgeslagen als de microSD-kaart vol is?	<ul style="list-style-type: none"><li>• Als de microSD-kaart vol is, zal het systeem de eerder opgenomen video's overschrijven. Bewaar belangrijke informatie tijdig.</li></ul>
Het apparaat is offline?	<p>Controleer de indicatorstatus:</p> <ul style="list-style-type: none"><li>• Als het groene lampje brandt, controleert u of de router verbinding heeft met internet. Start de camera opnieuw op als het internet werkt.</li><li>• Als het rode lampje knippert, stelt u de camera opnieuw in en configureert u de camera opnieuw.</li><li>• Als het rode lampje brandt, betekent dit dat de camera defect is.</li></ul>



# Quick Start Guide

Bullet 2S  
Bullet 2S 4MP

PT

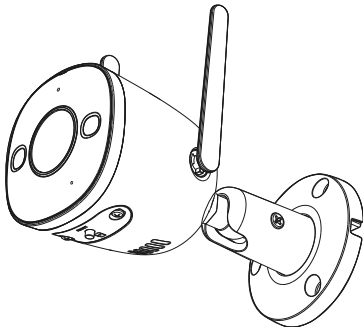

# Bem-vindo

Obrigado por escolher a IMOU.

Estamos empenhados em fornecer produtos inteligentes e simplificados para o lar. Se tiver problemas ao utilizar o produto, contacte a nossa equipa de assistência antes de devolver o produto.

PT

O nosso e-mail de assistência: [service.global@imoulife.com](mailto:service.global@imoulife.com)  
Prometemos responder no prazo de 24 horas.

Pode encontrar as Perguntas frequentes em [imoulife.com/support/help](https://imoulife.com/support/help)

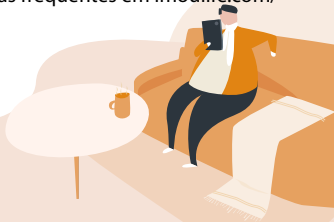

## Conteúdo da embalagem



Câmara x 1



Mapa de  
posicionamento x1



Conector impermeável x1



Pacote de parafusos x1



Guia de início rápido x1

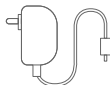

Adaptador de energia x1

PT

## Apresentação da câmara

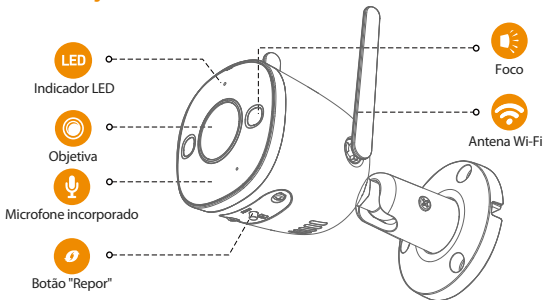

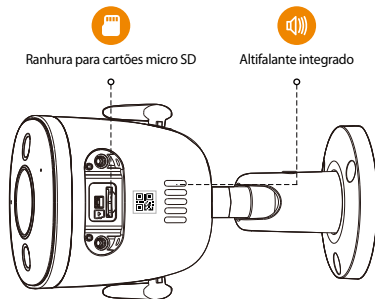

**O padrão dos indicadores LED está incluído na tabela seguinte.**

Estado do LED	Estado do dispositivo
DESLIGADO	<ul style="list-style-type: none"> <li>● Desligado/LED desligado</li> <li>● Reiniciar após a reposição</li> </ul>
Luz vermelha acesa	<ul style="list-style-type: none"> <li>● Arranque</li> <li>● Avaria do dispositivo</li> </ul>
Luz verde intermitente	<ul style="list-style-type: none"> <li>● À espera da rede</li> </ul>
Luz verde acesa	<ul style="list-style-type: none"> <li>● A funcionar corretamente</li> </ul>
Luz vermelha intermitente	<ul style="list-style-type: none"> <li>● Ligação à rede falhou</li> </ul>
Luz verde e luz vermelha intermitentes alternadamente	<ul style="list-style-type: none"> <li>● Atualização do firmware</li> </ul>

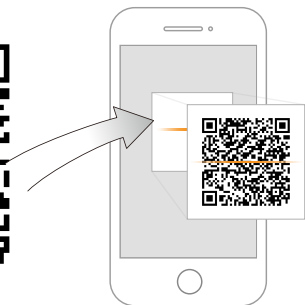

PT



## Dicas



Para assegurar o melhor desempenho possível do sistema sem fios, certifique-se de que não existem obstáculos e interferência eletromagnética entre a câmara e o router.

2

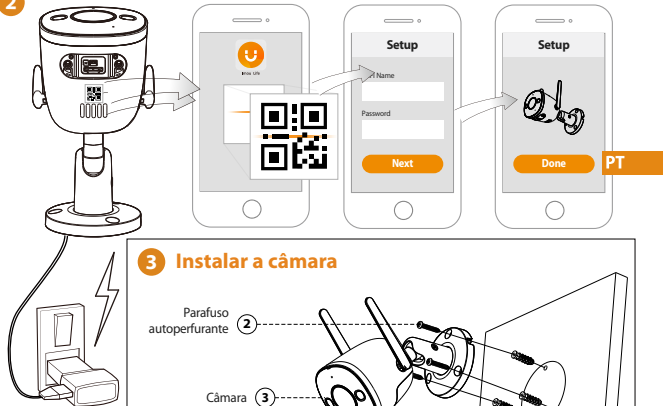

### 3 Instalar a câmara

Parafuso  
autoperfurante ②

Câmara ③

Parafuso de  
expansão ①

Mapa de  
posicionamento

Superfície de montagem

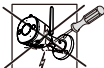
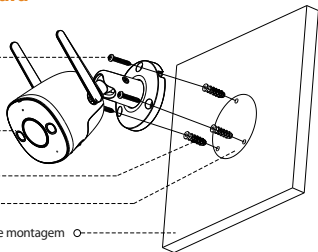

DC  
12V1A



## Solução de problema

Problema	Solução
A app informa "A configuração da rede do dispositivo falhou"	<ul style="list-style-type: none"><li>• Reponha a câmara e ligue-a novamente.</li><li>• Algumas câmaras suportam apenas 2,4 GHz, enquanto alguns routers possuem banda dupla, 2,4 G/5G. Certifique-se de que liga apenas a 2,4 GHz.</li></ul>
Sem áudio	<ul style="list-style-type: none"><li>• Certifique-se de que a função de áudio na câmara está ativada.</li><li>• Certifique-se que o áudio está ligado no dispositivo de visualização.</li></ul>
A deteção humana não está operacional	<ul style="list-style-type: none"><li>• Certifique-se de que ativou a "Deteção humana" no ecrã Definições do dispositivo da app Imou Life.</li></ul>
O dispositivo não funciona normalmente ou não inicia?	<ul style="list-style-type: none"><li>• Verifique o estado do indicador LED. Se a luz não estiver verde, prima sem soltar o botão de reiniciar durante 10 s para reiniciar a câmara.</li></ul>
Como ligar a câmara a uma rede Wi-Fi nova?	<ul style="list-style-type: none"><li>• Se a câmara estiver offline, reinicie a câmara e, em seguida, configure-a novamente.</li></ul>
A ligação está em prolongamento?	<ul style="list-style-type: none"><li>• Verifique se a distância entre a câmara e o router, a câmara e o smartphone é inferior a 5 m durante a ligação.</li></ul>
Quando o cartão micro SD está cheio, como é que o vídeo é gravado?	<ul style="list-style-type: none"><li>• Quando o cartão micro SD está cheio, o sistema substitui os vídeos gravados anteriormente. Guarde informação importante a tempo.</li></ul>
O dispositivo está offline?	<p>Verifique o estado do indicador:</p> <ul style="list-style-type: none"><li>• Se a luz verde estiver acesa, verifique se o router consegue ligar à internet. Se estiver ligado à internet, reinicie a câmara.</li><li>• Se a luz vermelha estiver a piscar, reinicie a câmara e, em seguida, configure-a novamente.</li><li>• Se a luz vermelha estiver ligada, significa que a câmara tem uma avaria.</li></ul>

# imou

Enjoy Smart Life



CE FC CCC UL  ISO 9001:2000

 @imouglobal

 service.global@imoulife.com

 www.imoulife.com