

Precision 3470

Service Manual

Notes, cautions, and warnings

 **NOTE:** A NOTE indicates important information that helps you make better use of your product.

 **CAUTION:** A CAUTION indicates either potential damage to hardware or loss of data and tells you how to avoid the problem.

 **WARNING:** A WARNING indicates a potential for property damage, personal injury, or death.

Chapter 1: Working inside your computer	6
Safety instructions.....	6
Before working inside your computer.....	6
Safety precautions.....	7
Electrostatic discharge—ESD protection.....	7
ESD field service kit	8
Transporting sensitive components.....	9
After working inside your computer.....	9
BitLocker.....	9
Chapter 2: Removing and installing components	10
Recommended tools.....	10
Screw list.....	10
Major components of Precision 3470.....	11
Micro Secure Digital (SD) Card.....	13
Removing the microSD card.....	13
Installing the microSD card.....	14
Base cover.....	14
Removing the base cover.....	14
Installing the base cover.....	16
Wireless card.....	17
Removing the wireless card.....	17
Installing the wireless card.....	19
Solid-state drives.....	21
Removing the 2230 solid-state drive	21
Installing the 2230 solid-state drive.....	22
Removing the 2280 solid-state drive.....	23
Installing the 2280 solid-state drive.....	24
Memory.....	25
Removing the memory modules.....	25
Installing the memory module.....	26
Battery.....	27
Lithium-ion battery precautions.....	27
Removing the 4-cell battery.....	28
Installing the 4-cell battery.....	28
Battery cable.....	29
Removing the 4-cell battery cable	29
Installing the 4-cell battery cable.....	30
Assembly inner frame.....	31
Removing the assembly inner frame.....	31
Installing the assembly inner frame.....	33
LED board.....	35
Removing the LED board.....	35
Installing the LED board.....	36











Heat sink.....	37
Removing the heat sink and fan assembly - UMA.....	37
Installing the heat sink and fan assembly - UMA.....	38
Speakers.....	39
Removing the speakers.....	39
Installing the speakers.....	40
System board.....	42
Removing the system board.....	42
Installing the system board.....	46
Power button with fingerprint reader.....	49
Removing the power button.....	49
Installing the power button.....	51
Smart card reader.....	52
Removing the smart card reader.....	52
Installing the smart card reader.....	53
Coin-cell battery.....	54
Removing the coin-cell battery.....	54
Installing the coin-cell battery.....	55
Keyboard assembly.....	55
Removing the keyboard assembly.....	55
Installing the keyboard assembly.....	57
Keyboard bracket.....	58
Removing the keyboard bracket.....	58
Installing the keyboard bracket.....	60
Display assembly.....	61
Removing the display assembly.....	61
Installing the display assembly.....	64
Display bezel.....	67
Removing the display bezel.....	67
Installing the display bezel.....	68
Display panel.....	69
Removing the display panel.....	69
Installing the display panel.....	73
Camera.....	76
Removing the camera.....	76
Installing the camera.....	78
Removing the infrared camera.....	79
Installing the infrared camera.....	81
eDP/display cable.....	82
Removing the eDP/display cable.....	82
Installing the eDP cable.....	83
Sensor board.....	84
Removing the sensor board.....	84
Installing the sensor board.....	85
Display hinges.....	86
Removing the display hinges.....	86
Installing the display hinges.....	87
Display back cover.....	89
Removing the display back cover.....	89
Installing the display back cover.....	89

Dummy SIM-card slot filler.....	90
Removing the dummy SIM-card slot filler.....	90
Installing the dummy SIM-card slot filler.....	92
Palm-rest assembly.....	95
Removing the palm-rest assembly.....	95
Installing the palm-rest assembly.....	96
Chapter 3: Drivers and downloads.....	99
Chapter 4: BIOS setup.....	100
Entering BIOS setup program.....	100
Navigation keys.....	100
One time boot menu.....	100
System setup options.....	101
Updating the BIOS.....	110
Updating the BIOS in Windows.....	110
Updating the BIOS in Linux and Ubuntu.....	111
Updating the BIOS using the USB drive in Windows.....	111
Updating the BIOS from the F12 One-Time boot menu.....	111
System and setup password.....	112
Assigning a system setup password.....	113
Deleting or changing an existing system setup password.....	113
Clearing CMOS settings.....	113
Clearing BIOS (System Setup) and System passwords.....	114
Chapter 5: Troubleshooting.....	115
Handling swollen Lithium-ion batteries.....	115
Dell SupportAssist Pre-boot System Performance Check diagnostics.....	115
Running the SupportAssist Pre-Boot System Performance Check.....	116
Built-in self-test (BIST).....	116
M-BIST.....	116
LCD Power rail test (L-BIST).....	117
LCD Built-in Self Test (BIST).....	117
System-diagnostic lights.....	117
Recovering the operating system.....	119
Real-Time Clock (RTC Reset).....	119
Auto RTC reset.....	119
Backup media and recovery options.....	120
WiFi power cycle.....	120
Drain residual flea power (perform hard reset).....	120
Chapter 6: Getting help and contacting Dell.....	121

Working inside your computer



Safety instructions

Use the following safety guidelines to protect your computer from potential damage and to ensure your personal safety. Unless otherwise noted, each procedure included in this document assumes that you have read the safety information that shipped with your computer.

-  **WARNING:** Before working inside your computer, read the safety information that is shipped with your computer. For more safety best practices, see the Regulatory Compliance home page at www.dell.com/regulatory_compliance.
-  **WARNING:** Disconnect your computer from all power sources before opening the computer cover or panels. After you finish working inside the computer, replace all covers, panels, and screws before connecting your computer to an electrical outlet.
-  **CAUTION:** To avoid damaging the computer, ensure that the work surface is flat, dry, and clean.
-  **CAUTION:** To avoid damaging the components and cards, handle them by their edges, and avoid touching the pins and the contacts.
-  **CAUTION:** You should only perform troubleshooting and repairs as authorized or directed by the Dell technical assistance team. Damage due to servicing that is not authorized by Dell is not covered by your warranty. See the safety instructions that is shipped with the product or at www.dell.com/regulatory_compliance.
-  **CAUTION:** Before touching anything inside your computer, ground yourself by touching an unpainted metal surface, such as the metal at the back of the computer. While you work, periodically touch an unpainted metal surface to dissipate static electricity which could harm internal components.
-  **CAUTION:** When you disconnect a cable, pull it by its connector or its pull tab, not the cable itself. Some cables have connectors with locking tabs or thumbscrews that you must disengage before disconnecting the cable. When disconnecting cables, keep them evenly aligned to avoid bending the connector pins. When connecting cables, ensure that the ports and the connectors are correctly oriented and aligned.
-  **CAUTION:** Press and eject any installed card from the media-card reader.
-  **CAUTION:** Exercise caution when handling Lithium-ion batteries in laptops. Swollen batteries should not be used and should be replaced and disposed properly.
-  **NOTE:** The color of your computer and certain components may appear differently than shown in this document.

Before working inside your computer

Steps

1. Save and close all open files and exit all open applications.
2. Shut down your computer. For Windows operating system, click **Start** >  **Power** > **Shut down**.
 -  **NOTE:** If you are using a different operating system, see the documentation of your operating system for shut-down instructions.
3. Disconnect your computer and all attached devices from their electrical outlets.
4. Disconnect all attached network devices and peripherals, such as keyboard, mouse, and monitor from your computer.

5. Remove any media card and optical disk from your computer, if applicable.
6. Enter the service mode, if you are able to power on your computer.

Service Mode

Service Mode is used to cut-off power, without disconnecting battery cable from system board prior conducting repairs in the computer.

CAUTION: If you are unable to turn on the computer to put it into Service Mode or the computer does not support Service Mode then proceed to disconnect the battery cable. To disconnect the battery cable, follow the steps in [Removing the battery](#).

NOTE: Ensure that your computer is shut down and the AC adapter is disconnected.

- a. Hold **** key on the keyboard and press the power button for 3 seconds or until the Dell logo appears on the screen.
- b. Press any key to continue.
- c. If the AC adapter is not disconnected, a message prompting you to remove the AC adapter appears on the screen. Remove the AC adapter and then press any key to continue the **Service Mode** procedure. The **Service Mode** procedure automatically skips the following step if the **Owner Tag** of the computer is not set up in advance by the user.
- d. When the ready-to-proceed message appears on the screen, press any key to proceed. The computer emits three short beeps and shuts down immediately.
- e. Once the computer shuts down, it has successfully entered Service Mode.

NOTE: If you are unable to power on your computer or unable to enter service mode skip this process.

Safety precautions

The safety precautions chapter details the primary steps to be taken before performing any disassembly instructions.

Observe the following safety precautions before you perform any installation or break/fix procedures involving disassembly or reassembly:

- Turn off the system and all attached peripherals.
- Disconnect the system and all attached peripherals from AC power.
- Disconnect all network cables, telephone, and telecommunications lines from the system.
- Use an ESD field service kit when working inside any notebook to avoid electrostatic discharge (ESD) damage.
- After removing any system component, carefully place the removed component on an anti-static mat.
- Wear shoes with non-conductive rubber soles to reduce the chance of getting electrocuted.

Standby power

Dell products with standby power must be unplugged before you open the case. Systems that incorporate standby power are essentially powered while turned off. The internal power enables the system to be remotely turned on (wake on LAN) and suspended into a sleep mode and has other advanced power management features.

Unplugging, pressing and holding the power button for 15 seconds should discharge residual power in the system board.

Bonding

Bonding is a method for connecting two or more grounding conductors to the same electrical potential. This is done through the use of a field service electrostatic discharge (ESD) kit. When connecting a bonding wire, ensure that it is connected to bare metal and never to a painted or non-metal surface. The wrist strap should be secure and in full contact with your skin, and ensure that you remove all jewelry such as watches, bracelets, or rings prior to bonding yourself and the equipment.

Electrostatic discharge—ESD protection

ESD is a major concern when you handle electronic components, especially sensitive components such as expansion cards, processors, memory DIMMs, and system boards. Very slight charges can damage circuits in ways that may not be obvious, such as intermittent problems or a shortened product life span. As the industry pushes for lower power requirements and increased density, ESD protection is an increasing concern.

Due to the increased density of semiconductors used in recent Dell products, the sensitivity to static damage is now higher than in previous Dell products. For this reason, some previously approved methods of handling parts are no longer applicable.

Two recognized types of ESD damage are catastrophic and intermittent failures.

- **Catastrophic** – Catastrophic failures represent approximately 20 percent of ESD-related failures. The damage causes an immediate and complete loss of device functionality. An example of catastrophic failure is a memory DIMM that has received a static shock and immediately generates a "No POST/No Video" symptom with a beep code emitted for missing or nonfunctional memory.
- **Intermittent** – Intermittent failures represent approximately 80 percent of ESD-related failures. The high rate of intermittent failures means that most of the time when damage occurs, it is not immediately recognizable. The DIMM receives a static shock, but the tracing is merely weakened and does not immediately produce outward symptoms related to the damage. The weakened trace may take weeks or months to melt, and in the meantime may cause degradation of memory integrity, intermittent memory errors, etc.

The more difficult type of damage to recognize and troubleshoot is the intermittent (also called latent or "walking wounded") failure.

Perform the following steps to prevent ESD damage:

- Use a wired ESD wrist strap that is properly grounded. The use of wireless anti-static straps is no longer allowed; they do not provide adequate protection. Touching the chassis before handling parts does not ensure adequate ESD protection on parts with increased sensitivity to ESD damage.
- Handle all static-sensitive components in a static-safe area. If possible, use anti-static floor pads and workbench pads.
- When unpacking a static-sensitive component from its shipping carton, do not remove the component from the anti-static packing material until you are ready to install the component. Before unwrapping the anti-static packaging, ensure that you discharge static electricity from your body.
- Before transporting a static-sensitive component, place it in an anti-static container or packaging.

ESD field service kit

The unmonitored Field Service kit is the most commonly used service kit. Each Field Service kit includes three main components: anti-static mat, wrist strap, and bonding wire.

Components of an ESD field service kit

The components of an ESD field service kit are:

- **Anti-Static Mat** – The anti-static mat is dissipative and parts can be placed on it during service procedures. When using an anti-static mat, your wrist strap should be snug and the bonding wire should be connected to the mat and to any bare metal on the system being worked on. Once deployed properly, service parts can be removed from the ESD bag and placed directly on the mat. ESD-sensitive items are safe in your hand, on the ESD mat, in the system, or inside a bag.
- **Wrist Strap and Bonding Wire** – The wrist strap and bonding wire can be either directly connected between your wrist and bare metal on the hardware if the ESD mat is not required, or connected to the anti-static mat to protect hardware that is temporarily placed on the mat. The physical connection of the wrist strap and bonding wire between your skin, the ESD mat, and the hardware is known as bonding. Use only Field Service kits with a wrist strap, mat, and bonding wire. Never use wireless wrist straps. Always be aware that the internal wires of a wrist strap are prone to damage from normal wear and tear, and must be checked regularly with a wrist strap tester in order to avoid accidental ESD hardware damage. It is recommended to test the wrist strap and bonding wire at least once per week.
- **ESD Wrist Strap Tester** – The wires inside of an ESD strap are prone to damage over time. When using an unmonitored kit, it is a best practice to regularly test the strap prior to each service call, and at a minimum, test once per week. A wrist strap tester is the best method for doing this test. If you do not have your own wrist strap tester, check with your regional office to find out if they have one. To perform the test, plug the wrist-strap's bonding-wire into the tester while it is strapped to your wrist and push the button to test. A green LED is lit if the test is successful; a red LED is lit and an alarm sounds if the test fails.
- **Insulator Elements** – It is critical to keep ESD sensitive devices, such as plastic heat sink casings, away from internal parts that are insulators and often highly charged.
- **Working Environment** – Before deploying the ESD Field Service kit, assess the situation at the customer location. For example, deploying the kit for a server environment is different than for a desktop or portable environment. Servers are typically installed in a rack within a data center; desktops or portables are typically placed on office desks or cubicles. Always look for a large open flat work area that is free of clutter and large enough to deploy the ESD kit with additional space to accommodate the type of system that is being repaired. The workspace should also be free of insulators that can cause an ESD event. On the work area, insulators such as Styrofoam and other plastics should always be moved at least 12 inches or 30 centimeters away from sensitive parts before physically handling any hardware components.

- **ESD Packaging** – All ESD-sensitive devices must be shipped and received in static-safe packaging. Metal, static-shielded bags are preferred. However, you should always return the damaged part using the same ESD bag and packaging that the new part arrived in. The ESD bag should be folded over and taped shut and all the same foam packing material should be used in the original box that the new part arrived in. ESD-sensitive devices should be removed from packaging only at an ESD-protected work surface, and parts should never be placed on top of the ESD bag because only the inside of the bag is shielded. Always place parts in your hand, on the ESD mat, in the system, or inside an anti-static bag.
- **Transporting Sensitive Components** – When transporting ESD sensitive components such as replacement parts or parts to be returned to Dell, it is critical to place these parts in anti-static bags for safe transport.

ESD protection summary

It is recommended that all field service technicians use the traditional wired ESD grounding wrist strap and protective anti-static mat at all times when servicing Dell products. In addition, it is critical that technicians keep sensitive parts separate from all insulator parts while performing service and that they use anti-static bags for transporting sensitive components.

Transporting sensitive components

When transporting ESD sensitive components such as replacement parts or parts to be returned to Dell, it is critical to place these parts in anti-static bags for safe transport.

After working inside your computer

About this task

 **CAUTION:** Leaving stray or loose screws inside your computer may severely damage your computer.

Steps

1. Replace all screws and ensure that no stray screws remain inside your computer.
2. Connect any external devices, peripherals, or cables you removed before working on your computer.
3. Replace any media cards, discs, or any other parts that you removed before working on your computer.
4. Connect your computer and all attached devices to their electrical outlets.
 -  **NOTE:** To exit service mode, ensure to connect the AC adapter to the power-adapter port on your computer.
5. Press the power button to turn on the computer. Your computer will automatically return to normal functioning mode.

BitLocker

 **CAUTION:** If BitLocker is not suspended before updating the BIOS, the next time you reboot the system it will not recognize the BitLocker key. You will then be prompted to enter the recovery key to progress, and the system will ask for this on each reboot. If the recovery key is not known this can result in data loss or an unnecessary operating system reinstall. For more information about this subject, see [Knowledge Article: updating the BIOS on Dell systems with BitLocker enabled](#).

The installation of the following components triggers BitLocker:

- Hard disk drive or solid state drive
- System board

Removing and installing components

NOTE: The images in this document may differ from your computer depending on the configuration you ordered.

Recommended tools

The procedures in this document may require the following tools:

- Phillips screwdriver #0
- Plastic scribe

Screw list

NOTE: When removing screws from a component, it is recommended to note the screw type, the quantity of screws, and then place them in a screw storage box. This is to ensure that the correct number of screws and correct screw type is restored when the component is replaced.

NOTE: Some computers have magnetic surfaces. Ensure that the screws are not left attached to such surfaces when replacing a component.

NOTE: Screw color may vary with the configuration ordered.

Table 1. Screw list





















Component	Screw type	Quantity	Screw image
Base cover	Captive screws	8	N/A
Wireless card	Captive screws	1	N/A
M.2 2230 solid-state drive	M2x3	4	
M.2 2280 solid-state drive	M2x3	2	
Assembly inner frame	M2x3	7	 
	M2x5	2	
4-cell battery	M2x3	2	
Heat sink with fan assembly - UMA	<ul style="list-style-type: none"> • M2x3 • M2x5 (for fan) 	<ul style="list-style-type: none"> • 4 • 2 	  
Heat sink with fan assembly - Discrete	<ul style="list-style-type: none"> • M2x3 • M2x5 (for fan) 	<ul style="list-style-type: none"> • 6 • 2 	 

Table 1. Screw list (continued)

Component	Screw type	Quantity	Screw image
eDP cable/bracket	M2x3	2	
USB Type-C support bracket	M2x5	3	
System board	M2x3	4	
Power button	M2x2.5	2	
Smart card reader	M2x2.5	3	
LED board	M2x3	1	
Keyboard assembly	M2x2	18	
Keyboard bracket	M2x2	5	
Display assembly	M2.5x5 (display hinges to palm-rest assembly)	4	
Display hinge	M2.5x3 (display hinges to display back cover)	4	
Display panel	M2.5x3	2	

Major components of Precision 3470

The following image shows the major components of Precision 3470.

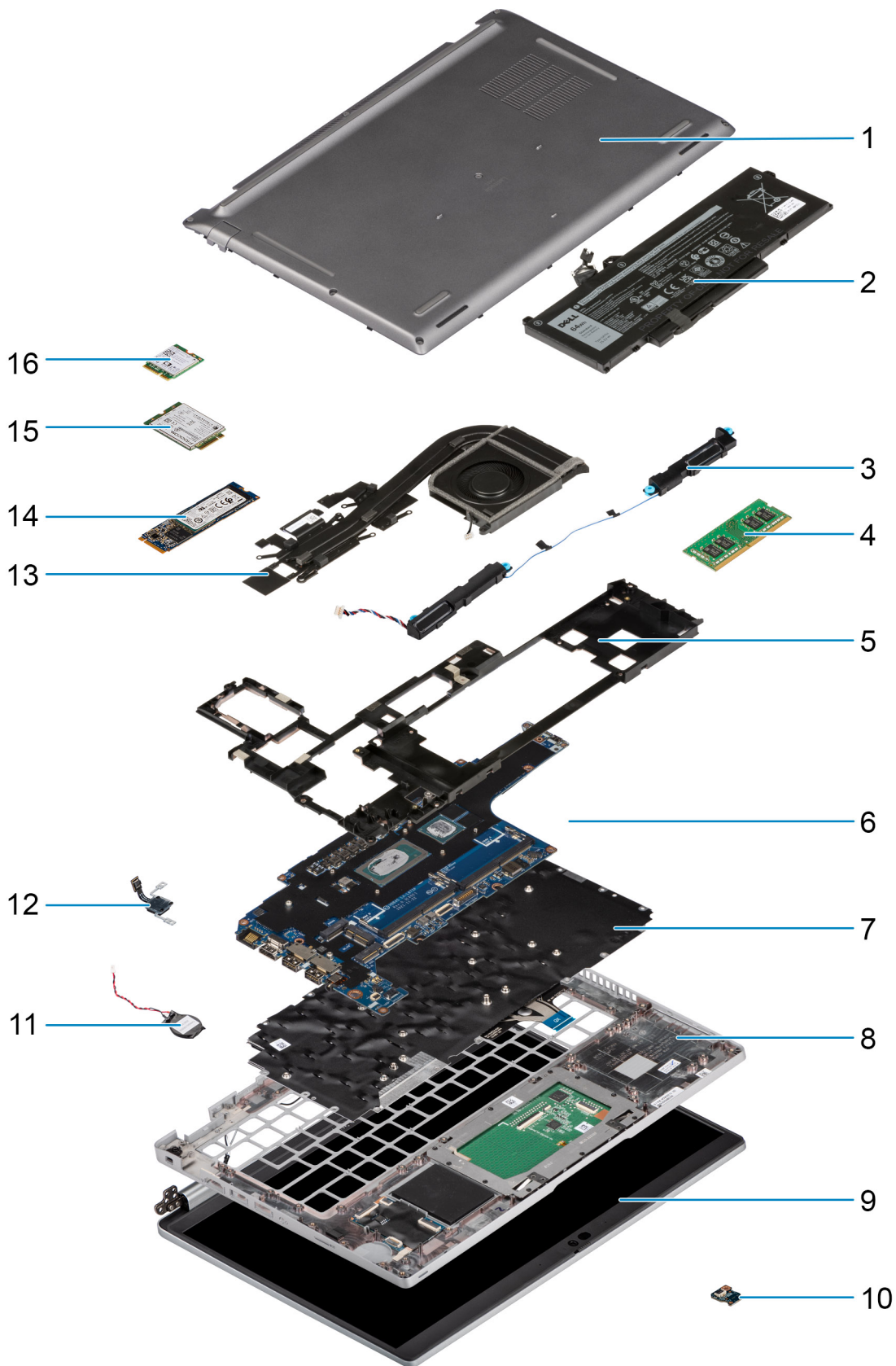

- 1. Base cover
- 3. Speakers
- 5. Assembly inner frame
- 7. Keyboard assembly

- 2. Battery
- 4. Memory module
- 6. System board
- 8. Palm-rest assembly

- 9. Display assembly
- 11. Coin-cell battery
- 13. Heat sink and fan assembly
- 15. WWAN card

- 10. Battery LED board
- 12. Power button/fingerprint board
- 14. Solid-state drive
- 16. WLAN card

NOTE: Dell provides a list of components and their part numbers for the original system configuration purchased. These parts are available according to warranty coverages purchased by the customer. Contact your Dell sales representative for purchase options.

Micro Secure Digital (SD) Card

Removing the microSD card

Prerequisites

1. Follow the procedure in [Before working inside your computer](#).

About this task

The following images indicate the location of the microSD card and provide a visual representation of the removal procedure.



Steps

1. Push the microSD card to release it from the computer.
2. Slide the microSD card out of the computer.

Installing the microSD card

Prerequisites

If you are replacing a component, remove the existing component before performing the installation procedure.

About this task

The following images indicate the location of the microSD card and provides a visual representation of the installation procedure.



Steps

1. Align the microSD card to its slot on the computer.
2. Slide the microSD card into the slot until it clicks into place.

Next steps

1. Follow the procedure in [After working inside your computer](#).

Base cover

Removing the base cover

Prerequisites

1. Follow the procedure in [Before working inside your computer](#).
2. Remove the [microSD card](#).

About this task

The following images indicate the location of the base cover and provide a visual representation of the removal procedure.



8x

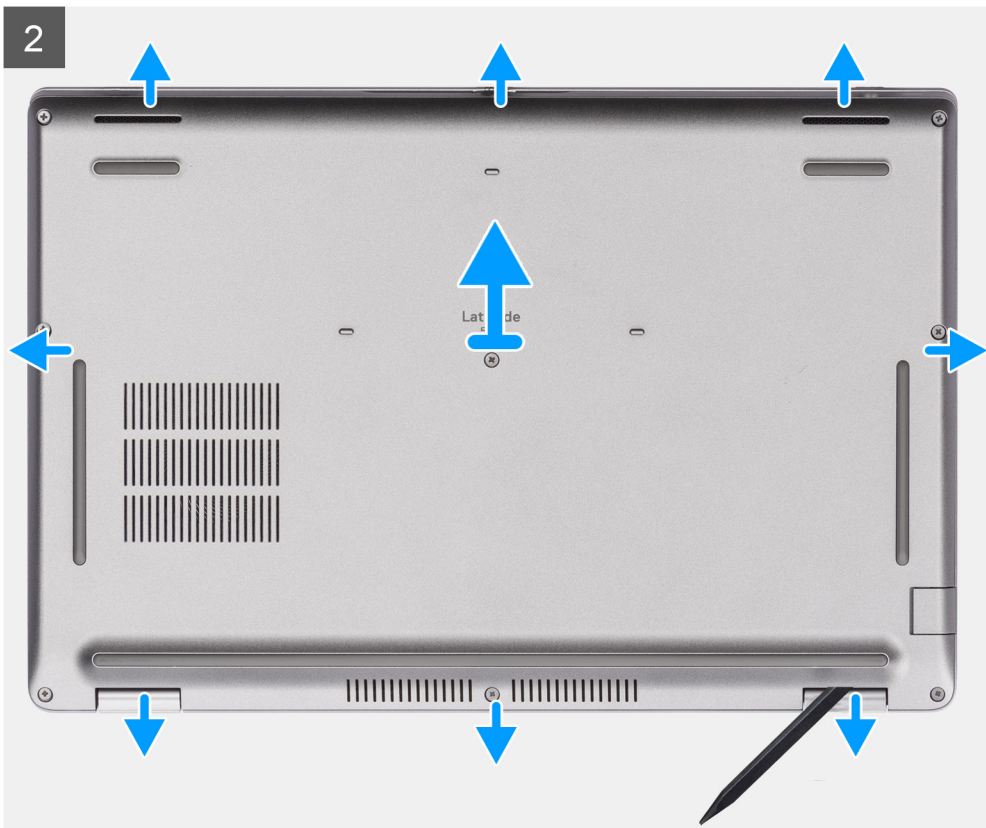

Steps

1. Loosen the eight captive screws that secure the base cover to the palm-rest and keyboard assembly.
2. Using the flat-end of plastic scribe, pry the base cover from the U-shaped indents at the top edge of the base cover and continue to work on the sides to release the base cover from the palm-rest and keyboard assembly.
3. Lift the base cover off the palm-rest and keyboard assembly.

Installing the base cover

Prerequisites

If you are replacing a component, remove the existing component before performing the installation procedure.

About this task

The following images indicate the location of the base cover and provide a visual representation of the installation procedure.

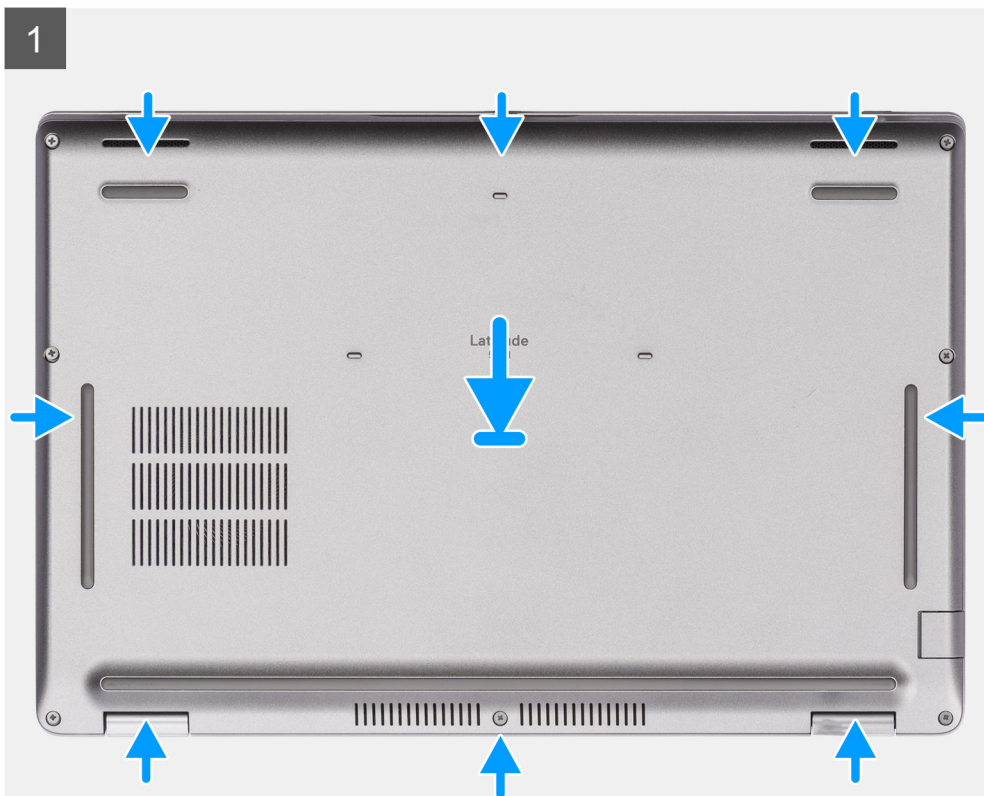



Steps

1. Align the screw holes on the base cover with the screw holes on the palm-rest assembly and keyboard assembly, and then snap the base cover into place.
2. Tighten the eight captive screws that secure the base cover to the palm-rest and keyboard assembly.

Next steps

1. Install the [microSD card](#).
2. Follow the procedure in [After working inside your computer](#).

Wireless card

Removing the wireless card

Prerequisites

1. Follow the procedure in [Before working inside your computer](#).
2. Remove the [microSD card](#).
3. Remove the [base cover](#).

About this task

The following images indicate the location of the wireless card and provide a visual representation of the removal procedure.



1x
M2x3.5

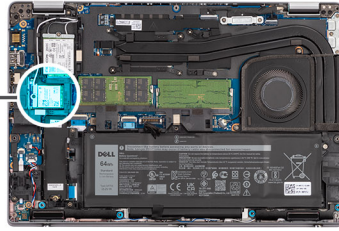

Steps

1. **i** **NOTE:** When removing the wireless card from the computer, if the adhesive pad which helps secure the wireless card in place is removed from the computer along with the WLAN card, adhere it back to the computer.

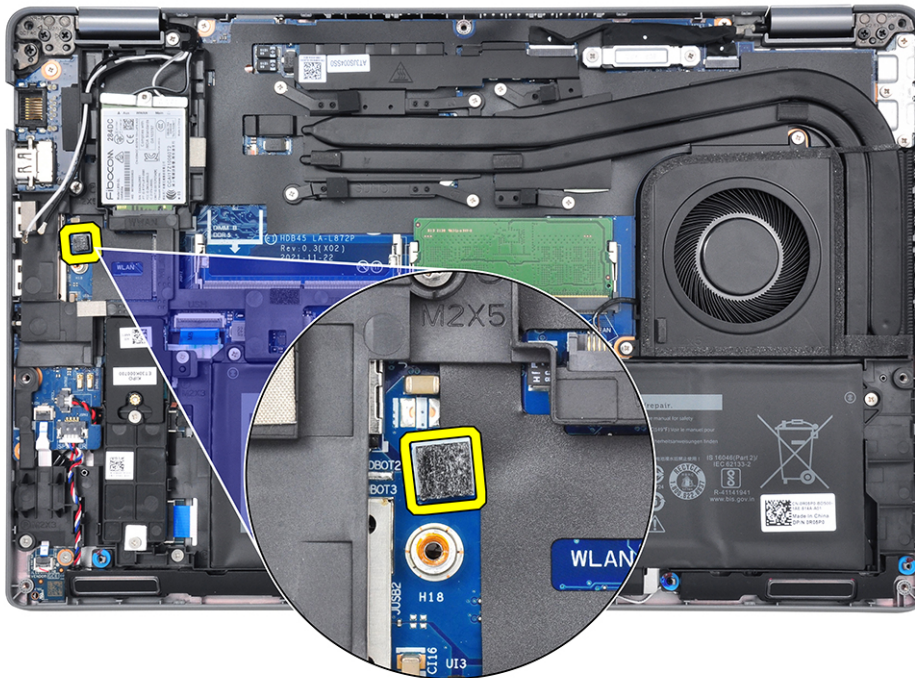

Loosen the single (M2x3.5) screw that secures the wireless-card bracket to the wireless card and system board.

2. Remove the wireless-card bracket from the wireless card.
3. Disconnect the antenna cables from the wireless card.
4. Slide and remove the wireless card from the wireless-card slot.

Installing the wireless card

Prerequisites

If you are replacing a component, remove the existing component before performing the installation procedure.

About this task

The following image indicate the location of the wireless card and provides a visual representation of the installation procedure.



1x
M2x3.5

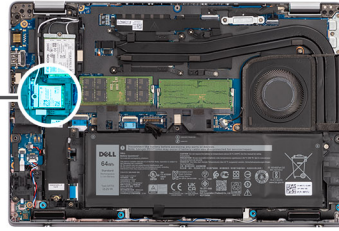

Steps

1. Connect the antenna cables to the wireless card.

The following table provides the antenna-cable color scheme:

Table 2. Antenna-cable color scheme

Connectors on the wireless card	Antenna-cable color	Silkscreen marking	
Main	White	MAIN	△ (white triangle)
Auxiliary	Black	AUX	▲ (black triangle)

2. Align the notch on the wireless card with the tab on the wireless-card slot on the system board.
3. Slide and insert the wireless card at an angle into the wireless-card slot on the system board.
4. Align the screw hole on the wireless-card bracket to the screw hole on the wireless card and system board.
5. Tighten the single (M2x3.5) screw that secures the wireless-card bracket to the wireless card and the system board.

Next steps

1. Install the [microSD card](#).
2. Install the [base cover](#).
3. Follow the procedure in [After working inside your computer](#).

Solid-state drives

Removing the 2230 solid-state drive

Prerequisites

1. Follow the procedure in [Before working inside your computer](#).
 - NOTE:** Solid-state drives are fragile. Exercise care when handling the solid-state drive.
 - NOTE:** To avoid data loss, do not remove the solid-state drive while the computer is in sleep or on state.
2. Remove the [microSD card](#).
3. Remove the [base cover](#).

About this task

- NOTE:** Depending on the configuration ordered, your computer may support a 2230 solid-state drive, or a 2280 solid-state drive in M.2 slot.
- NOTE:** This procedure applies only to computers shipped with a 2230 solid-state drive installed in M.2 slot.

The following image indicates the location of the 2230 solid-state drive that is installed and provides a visual representation of the removal procedure.

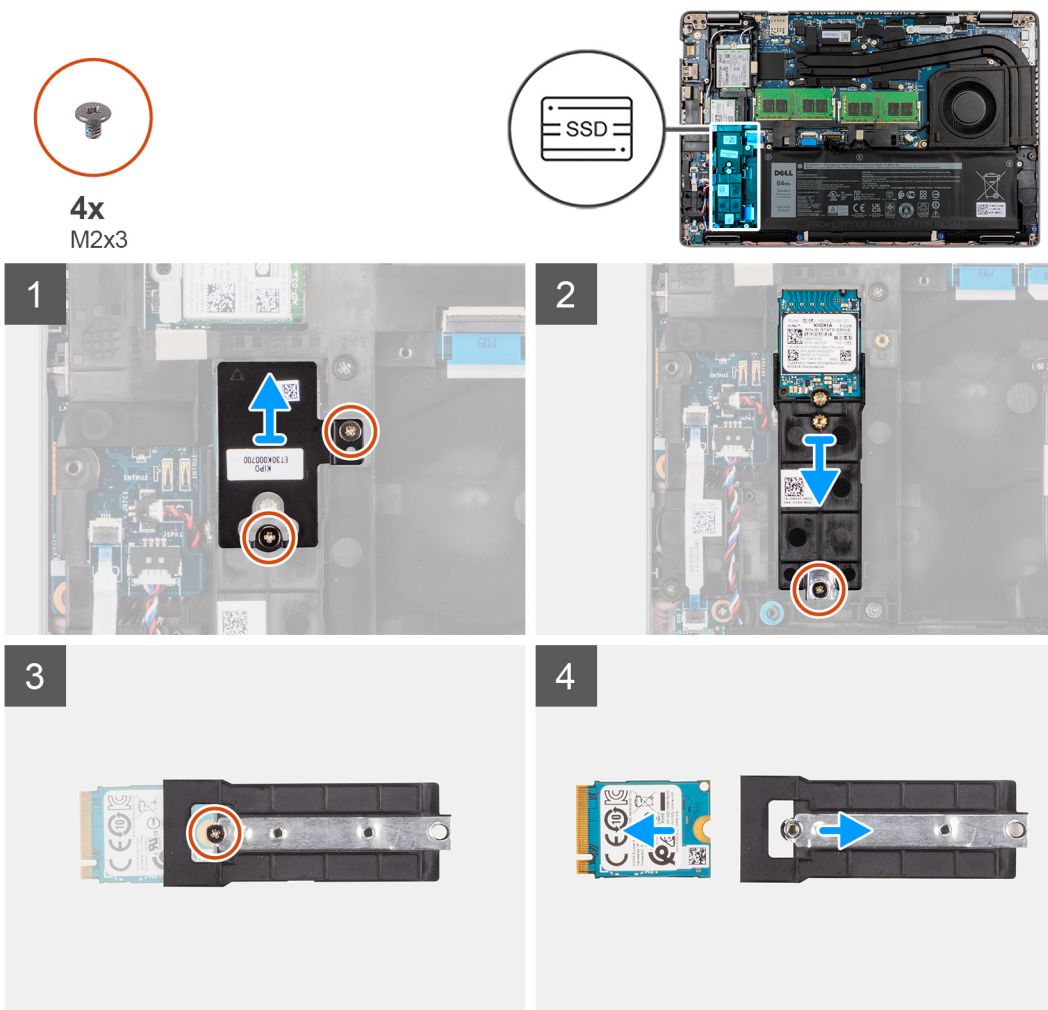

Steps

1. Remove the two (M2x3) screws that secures the thermal plate to the palm-rest assembly.
2. Remove the single (M2x3) screw securing the solid-state drive assembly in place.
3. Slide and remove the solid-state drive assembly from the computer.
4. Remove the single (M2x3) screw securing the solid-state drive bracket in place.
5. Slide and remove the solid-state drive bracket out of the computer.
6. Slide and remove the solid-state drive from the M.2 slot.

Installing the 2230 solid-state drive

Prerequisites

If you are replacing a component, remove the existing component before performing the installation procedure.

About this task

- NOTE:** Solid-state drives are fragile. Exercise care when handling the solid-state drive.
- NOTE:** Depending on the configuration ordered, your computer may support a 2230 solid-state drive, or a 2280 solid-state drive in M.2 slot.
- NOTE:** This procedure applies only if you are installing a 2230 solid-state drive in M.2 slot. When you install the M.2 2230 solid-state drive after purchase, you must purchase a customer kit that includes holder and a screw to install the M.2 2230 solid-state drive,

The following images indicate the location of the 2230 solid-state drive and provides a visual representation of the installation procedure.



4x
M2x3

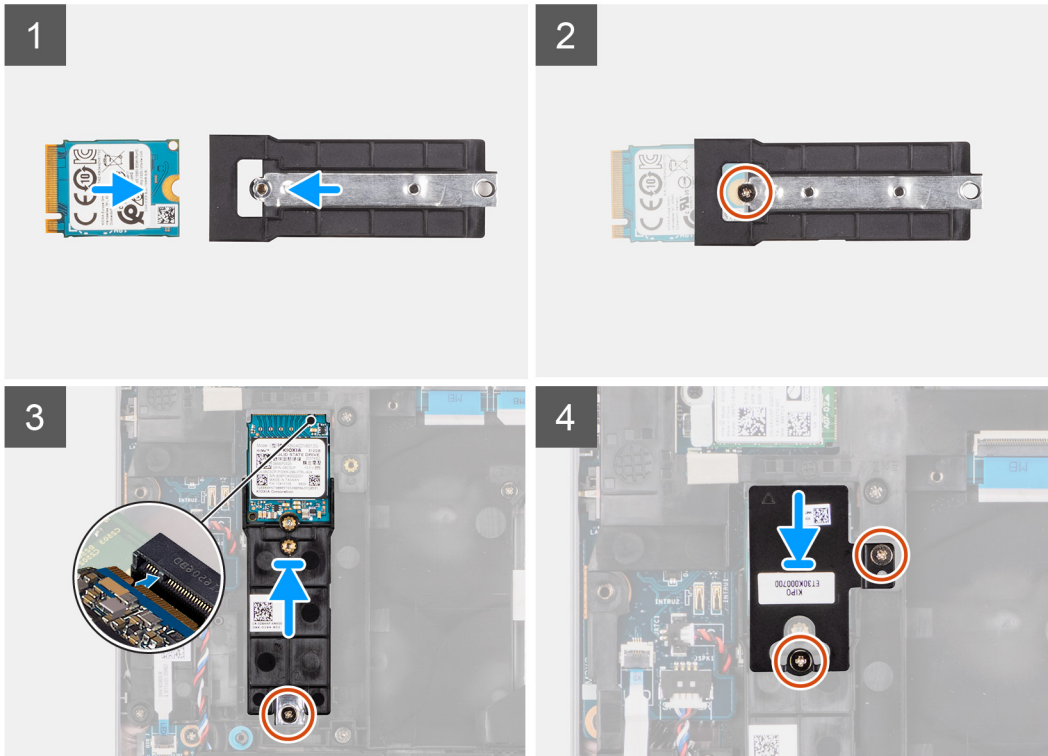
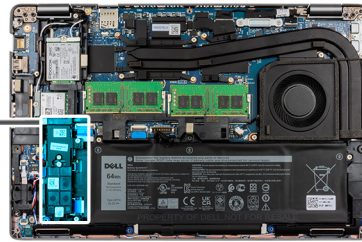

Steps

1. Align the notch on the M.2 2230 solid-state drive with the tab on the solid-state drive slot.
2. Slide the M.2 2230 solid-state drive into the solid-state drive slot on the system board
3. Replace the single screw (M2x3) that secures the solid-state drive to the holder and system board.

i **NOTE:** If the computer is not shipped with a M.2 2230 solid-state drive, you must obtain a customer kit that includes holder and a screw to install the M.2 2230 solid-state drive.

4. Align and place the solid-state drive thermal plate on the 2230 solid-state drive slot.
5. Replace the two screws (M2x3) that secure the solid-state drive thermal plate to the palm-rest and keyboard assembly.

Next steps

1. Install the [microSD card](#).
2. Install the [base cover](#).
3. Follow the procedure in [After working inside your computer](#).

Removing the 2280 solid-state drive

Prerequisites

1. Follow the procedure in [Before working inside your computer](#).

i **NOTE:** Solid-state drives are fragile. Exercise care when handling the solid-state drive.

NOTE: To avoid data loss, do not remove the solid-state drive while the computer is in sleep or on state.

2. Remove the [microSD card](#).
3. Remove the [base cover](#).

About this task

NOTE: Depending on the configuration ordered, your computer may support a 2280 solid-state drive, or a 2230 solid-state drive in M.2 slot.

NOTE: This procedure applies only to computers shipped with a 2280 solid-state drive installed in M.2 slot.

The following image indicates the location of the 2280 solid-state drive that is installed in M.2 slot and provides a visual representation of the removal procedure.

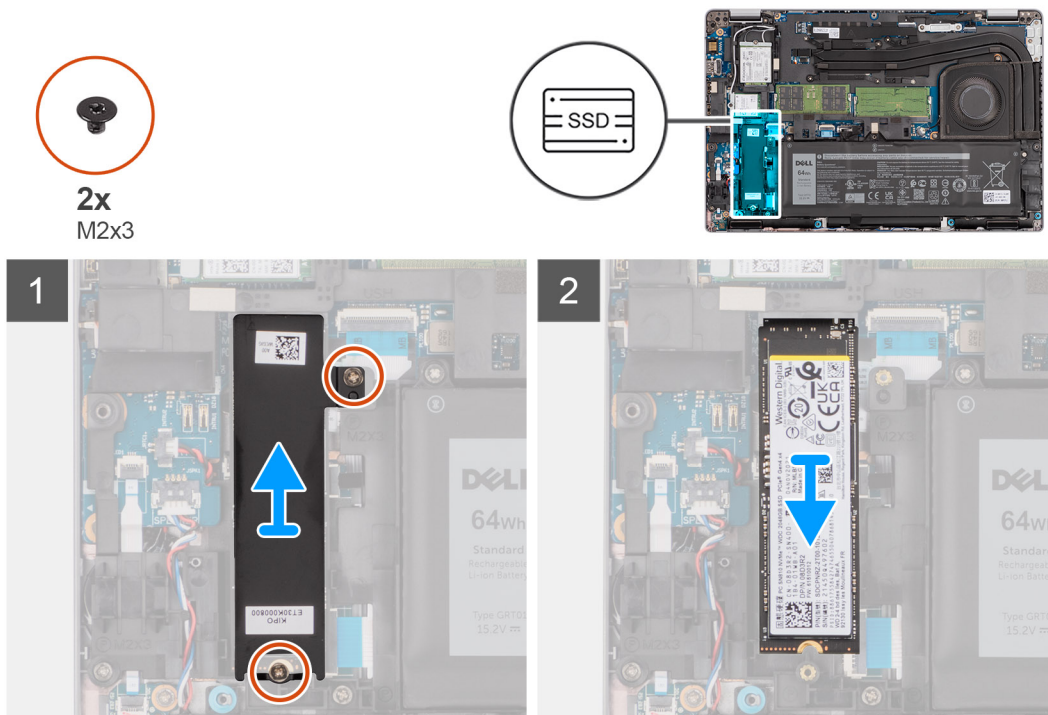

Steps

1. Remove the two screws (M2x3) that secure the solid-state drive thermal plate to the palm-rest and keyboard assembly.
2. Remove the solid-state drive thermal plate out of the computer.
3. Slide and remove the 2280 solid-state drive from the M.2 solid-state drive slot on the system board.

Installing the 2280 solid-state drive

Prerequisites

If you are replacing a component, remove the existing component before performing the installation procedure.

About this task

NOTE: Solid-state drives are fragile. Exercise care when handling the solid-state drive.

NOTE: Depending on the configuration ordered, the computer one may support a 2280 solid-state drive, or a 2230 solid-state drive in M.2 slot.

NOTE: This procedure is applicable if you are installing a 2280 solid-state drive in M.2 slot.

The following images indicate the location of the 2280 solid-state drive that is installed in M.2 slot and provides a visual representation of the installation procedure.

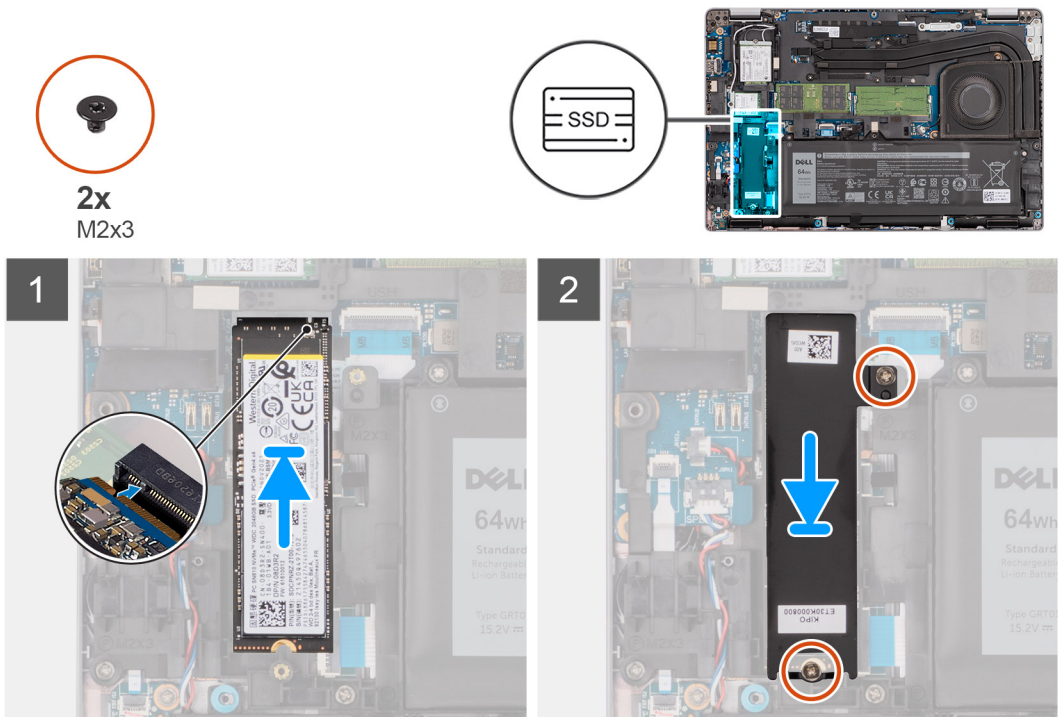

Steps

1. Align the notch on the M.2 2280 solid-state drive with the tab on the M.2 solid-state drive slot.
2. Slide the M.2 2280 solid-state drive into the M.2 solid-state drive slot on the system board.
3. Place the solid-state drive thermal plate over the solid-state drive.
4. Align the screw holes on the solid-state drive and thermal plate with the screw hole on the palm-rest and keyboard assembly.
5. Replace the two screws (M2x3) that secure the 2280 solid-state drive and thermal plate to the palm-rest and keyboard assembly.

Next steps

1. Install the [microSD card](#).
2. Install the [base cover](#).
3. Follow the procedure in [After working inside your computer](#).

Memory

Removing the memory modules

Prerequisites

1. Follow the procedure in [Before working inside your computer](#).
2. Remove the [microSD card](#).
3. Remove the [base cover](#).

About this task

i **NOTE:** The system supports two memory slots.

The following image indicates the location of the memory module and provides a visual representation of the removal procedure.

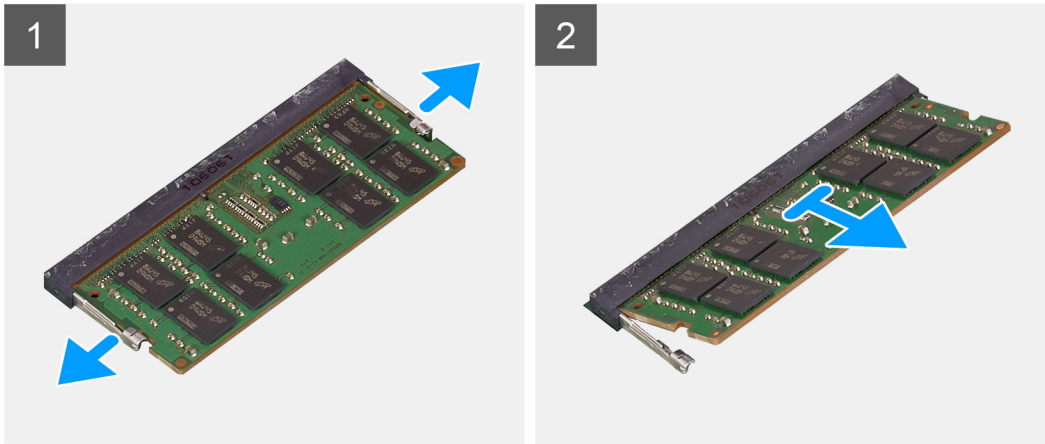
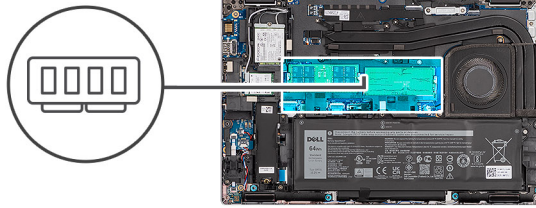

Steps

1. Using your fingertips, spread apart the securing clips on the memory-module slot until the memory module pops up.
2. Slide and remove the memory module from the memory-module slot.

i **NOTE:** Repeat step 1 to step 2 to remove any other memory modules installed in your computer.

Installing the memory module

Prerequisites

If you are replacing a component, remove the existing component before performing the installation procedure.

About this task

i **NOTE:** The system supports two memory slots.

The following images indicate the location of the memory module and provide a visual representation of the installation procedure.

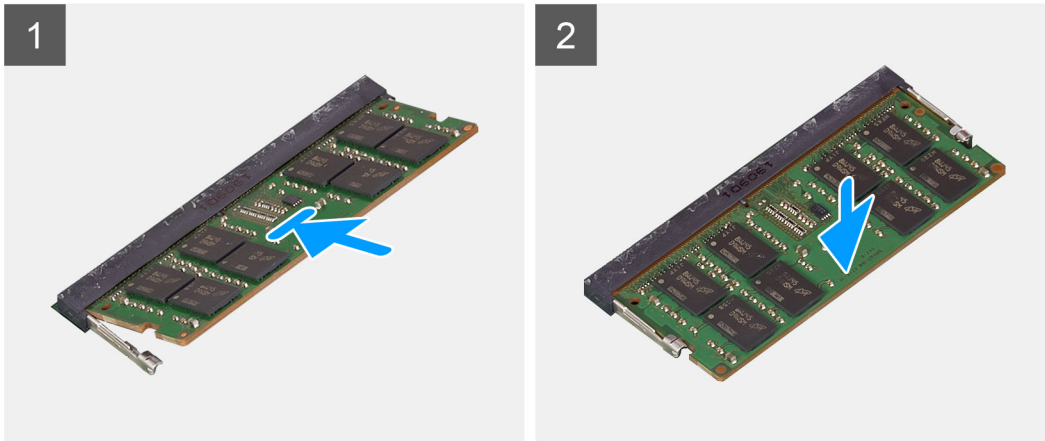
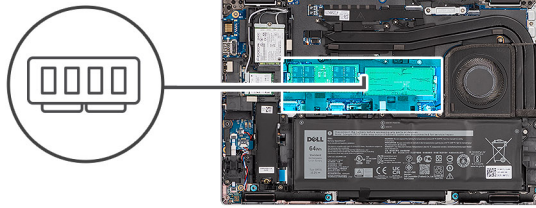

Steps

1. Align the notch on the memory module with the tab on the memory-module slot.
2. Slide the memory module firmly into the slot at an angle and press the memory module down until it clicks into place.

i **NOTE:** If you do not hear the click, remove the memory module and reinstall it.

i **NOTE:** Repeat step 1 to step 4 to install any other memory modules in your computer.

Next steps

1. Install the [microSD card](#).
2. Install the [base cover](#).
3. Follow the procedure in [After working inside your computer](#).

Battery

Lithium-ion battery precautions

CAUTION:

- Exercise caution when handling Lithium-ion batteries.
- Discharge the battery completely before removing it. Disconnect the AC power adapter from the system and operate the computer solely on battery power—the battery is fully discharged when the computer no longer turns on when the power button is pressed.
- Do not crush, drop, mutilate, or penetrate the battery with foreign objects.
- Do not expose the battery to high temperatures, or disassemble battery packs and cells.
- Do not apply pressure to the surface of the battery.
- Do not bend the battery.
- Do not use tools of any kind to pry on or against the battery.

- Ensure any screws during the servicing of this product are not lost or misplaced, to prevent accidental puncture or damage to the battery and other system components.
- If the battery gets stuck inside your computer as a result of swelling, do not try to release it as puncturing, bending, or crushing a lithium-ion battery can be dangerous. In such an instance, contact Dell technical support for assistance. See www.dell.com/contactdell.
- Always purchase genuine batteries from www.dell.com or authorized Dell partners and resellers.
- Swollen batteries should not be used and should be replaced and disposed properly. For guidelines on how to handle and replace swollen Lithium-ion batteries, see [Handling swollen Lithium-ion batteries](#).

Removing the 4-cell battery

Prerequisites

1. Follow the procedure in [Before working inside your computer](#).
2. Remove the [microSD card](#).
3. Remove the [base cover](#).

About this task

The following images indicate the location of the 4-cell (64 Wh) battery and provides a visual representation of the removal procedure.

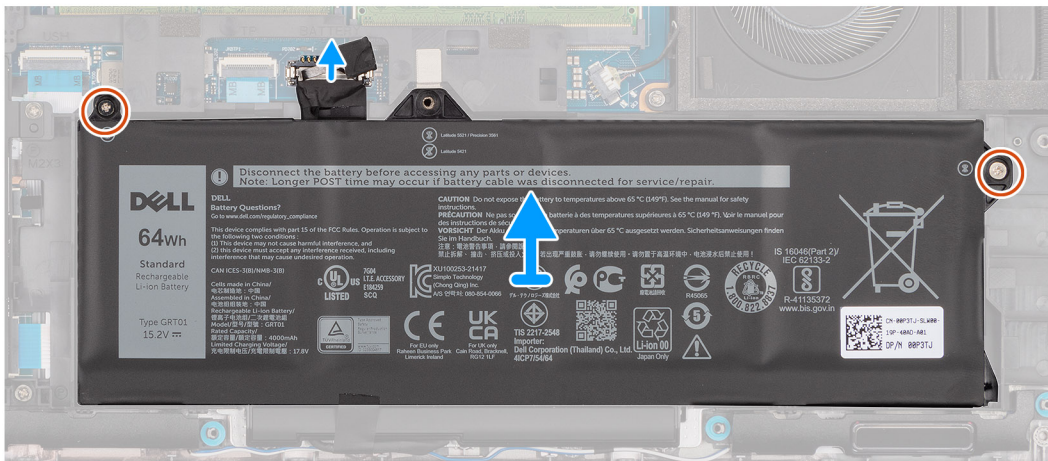
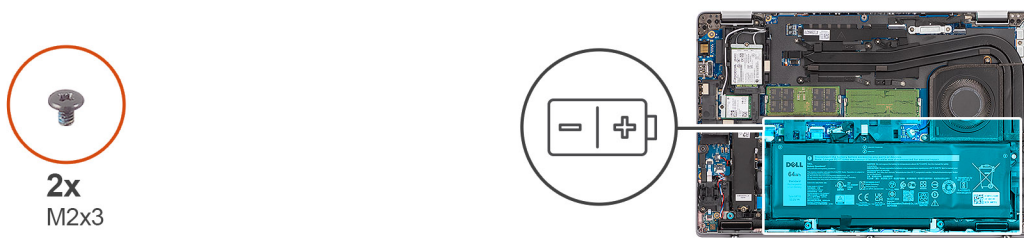

Steps

1. Disconnect the battery cable from the connector on the system board, if it was not disconnected earlier.
2. Remove the two screws (M2x3) that secure the 4-cell battery to the palm-rest and keyboard assembly.
3. Lift the 4-cell battery, along with its cable, off the palm-rest and keyboard assembly.

Installing the 4-cell battery

Prerequisites

If you are replacing a component, remove the existing component before performing the installation procedure.

About this task

The following images indicate the location of the 4-cell (64 Wh) battery and provide a visual representation of the installation procedure.

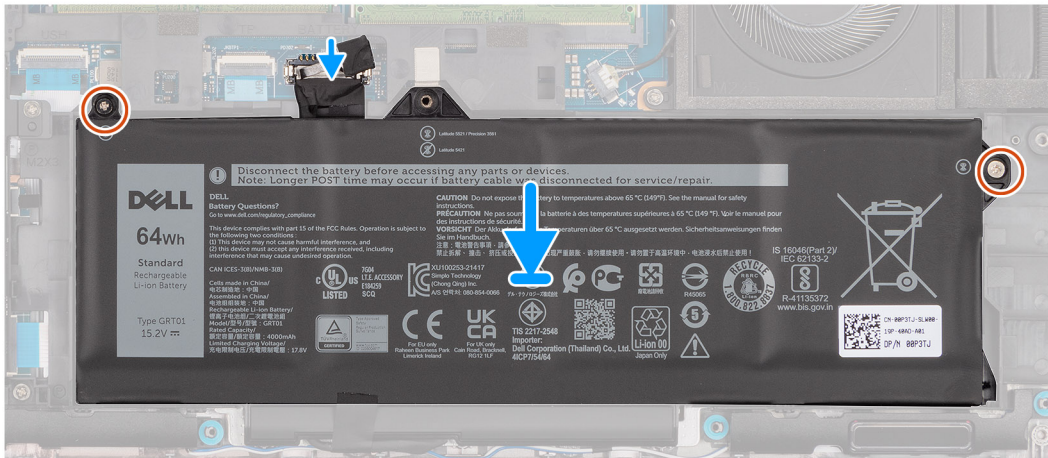
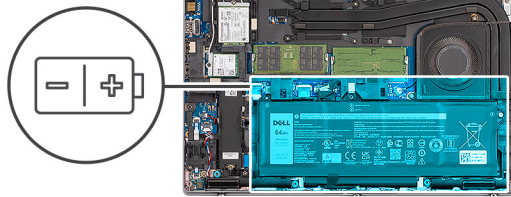

Steps

1. Align the screw holes on the 4-cell battery with the screw holes on the palm-rest and keyboard assembly.
2. Replace the two screws (M2x3) that secure the 4-cell battery to the palm-rest and keyboard assembly.
3. Connect the battery cable to the connector on the system board.

Next steps

1. Install the [microSD card](#).
2. Install the [base cover](#).
3. Follow the procedure in [After working inside your computer](#).

Battery cable

Removing the 4-cell battery cable

Prerequisites

1. Follow the procedure in [Before working inside your computer](#).
2. Remove the [microSD card](#).
3. Remove the [base cover](#).
4. Remove the [battery](#).

NOTE: If battery is disconnected from system board for service, then there is a delay during system boot as the system undergoes RTC battery reset.

About this task

The following images indicate the location of the battery cable and provide a visual representation of the removal procedure.

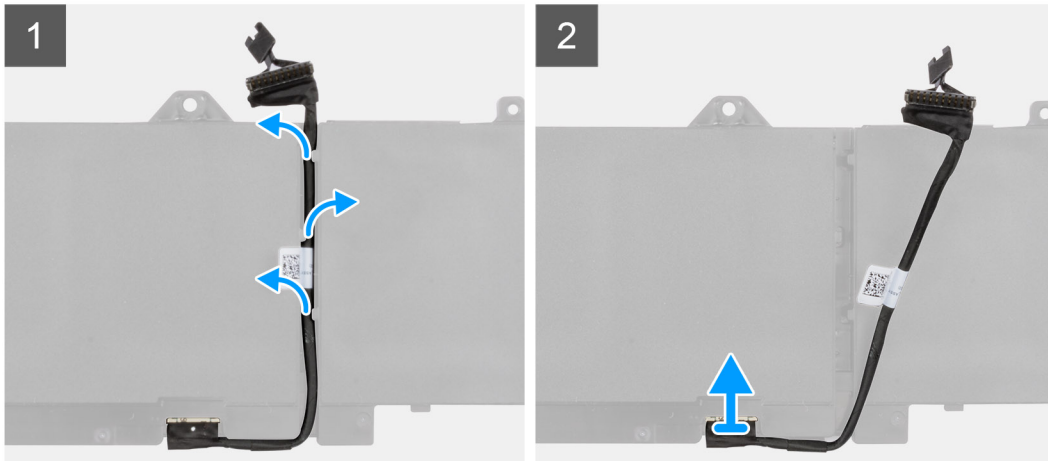

Steps

1. Flip the battery and unroute the battery cable from the routing guides on the battery.
2. Disconnect the battery cable from the connector on the battery.
3. Lift the battery cable away from the battery.

Installing the 4-cell battery cable

Prerequisites

If you are replacing a component, remove the existing component before performing the installation procedure.

About this task

The following images indicate the location of the battery cable and provide a visual representation of the installation procedure.

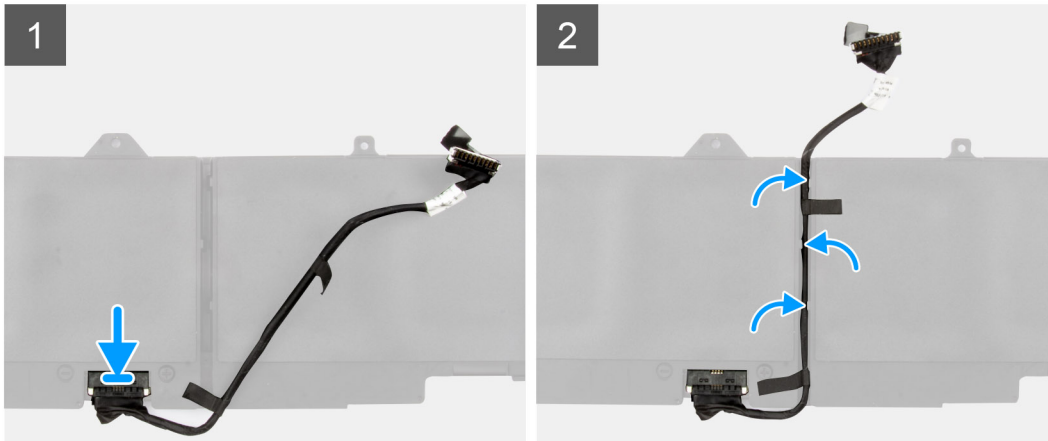
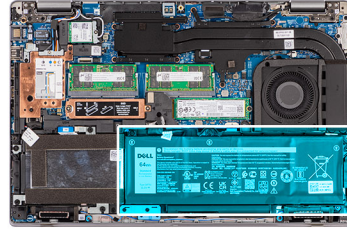

Steps

1. Connect the battery cable to the connector on the battery.
2. Route the battery cable through the routing guides on the battery.

Next steps

1. Install the [battery](#).
2. Install the [microSD card](#).
3. Install the [base cover](#).
4. Follow the procedure in [After working inside your computer](#).

Assembly inner frame

Removing the assembly inner frame

Prerequisites

1. Follow the procedure in [Before working inside your computer](#).
2. Remove the [microSD card](#).
3. Remove the [base cover](#).
4. Remove the [battery](#).
5. Remove the [wireless card](#).

About this task

The following images indicate the location of the assembly inner frame and provide a visual representation of the removal procedure.



2x
M2x5



7x
M2x3

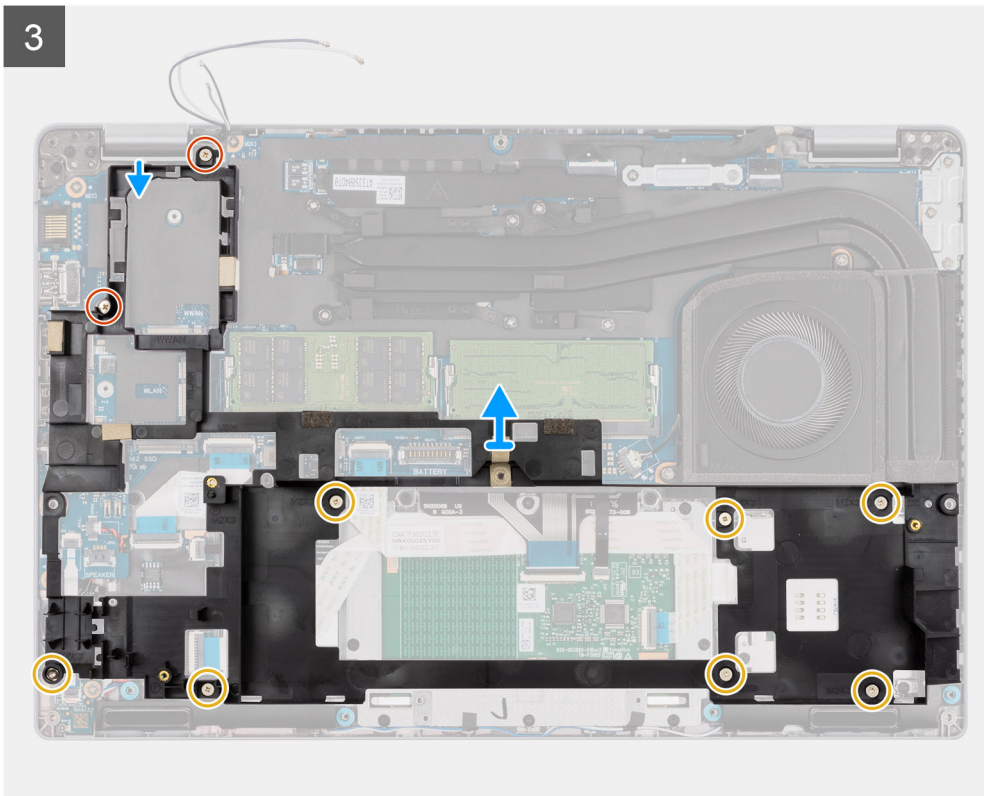
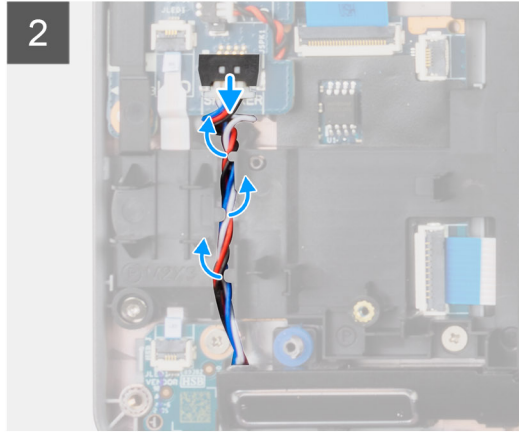
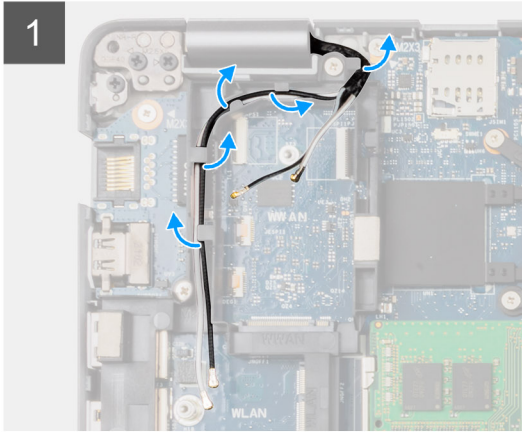
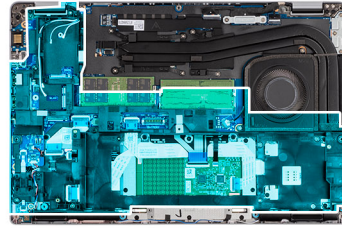

Steps

1. Unroute the antenna cables from the routing guides on the assembly inner frame.
2. Remove the two screws (M2x5) and seven screws (M2x3) that secure the assembly inner frame to the system board and the palm-rest assembly.
3. Lift the assembly inner frame off the system board and the palm-rest assembly.

Installing the assembly inner frame

Prerequisites

If you are replacing a component, remove the existing component before performing the installation procedure.

About this task

The following image indicates the location of the assembly inner frame and provides a visual representation of the installation procedure.

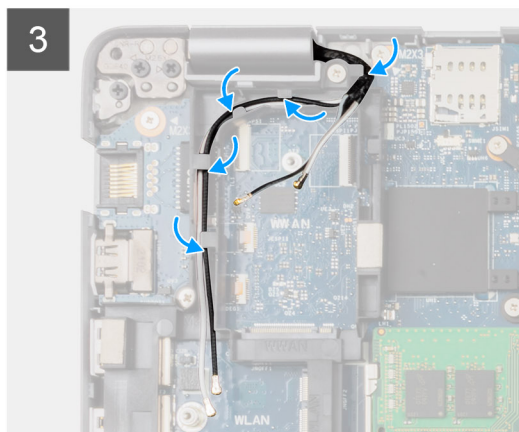
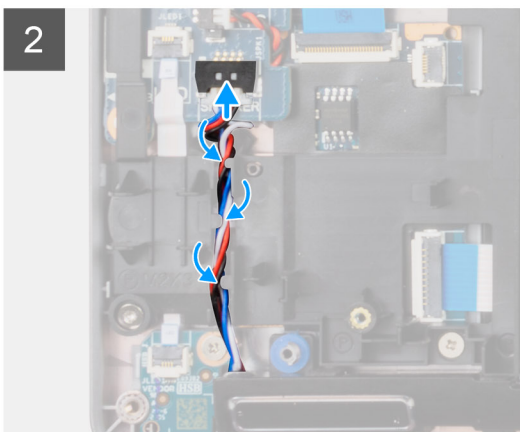
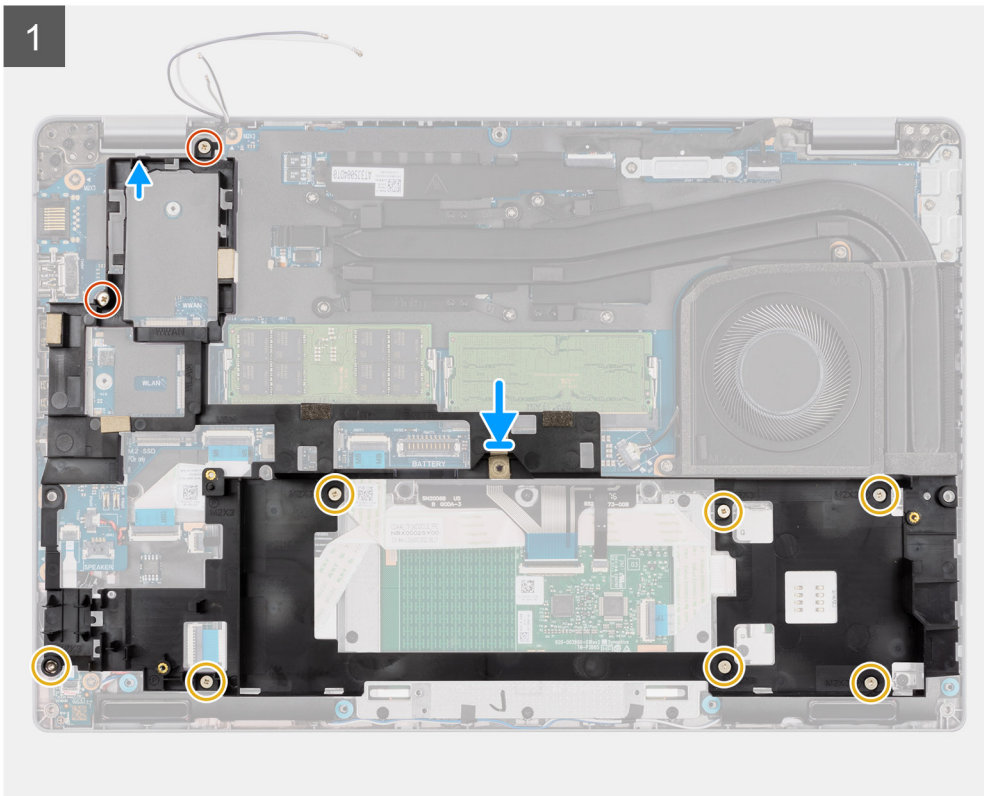
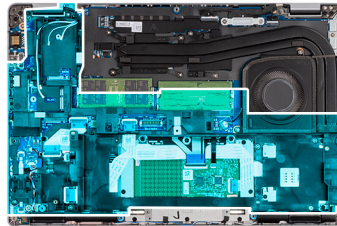

Steps

1. Align the screw holes on the assembly inner frame with the screw holes on the system board and the palm-rest assembly.
NOTE: Ensure that the tab on the top-left corner of the assembly inner frame is installed underneath the tab on the palm-rest assembly.

Inner Frame

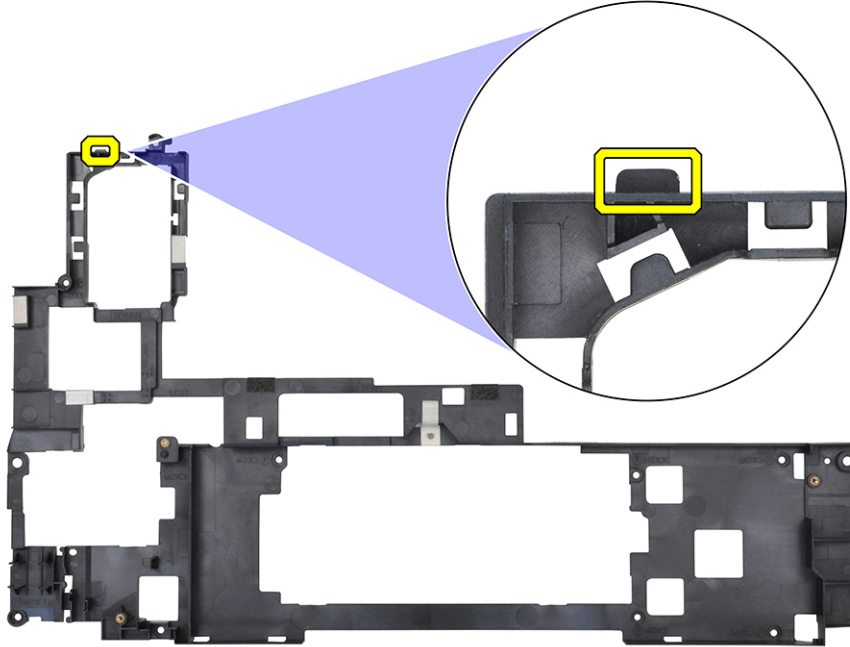

palm-rest assembly

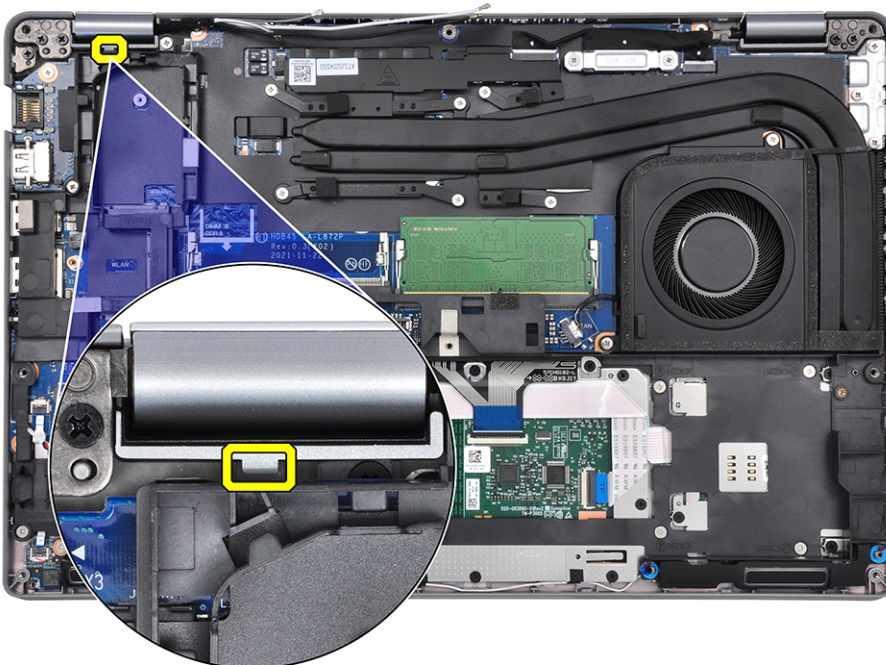

2. Replace the two screws (M2x5) and seven screws (M2x3) that secure the assembly inner frame to the system board and the palm-rest assembly.
3. Align and place the fingerprint bracket on the assembly inner frame.
4. Route the antennas cable through the routing guides on the assembly inner frame.

Next steps

1. Install the [battery](#).
2. Install the [wireless card](#).
3. Install the [base cover](#).
4. Install the [microSD card](#).
5. Follow the procedure in [After working inside your computer](#).

LED board

Removing the LED board

Prerequisites

1. Follow the procedure in [Before working inside your computer](#).
2. Remove the [microSD card](#).
3. Remove the [base cover](#).
4. Remove the [2280 solid-state drive](#) or [2230 solid-state drive](#).
5. Remove the [battery](#).
6. Remove the [wireless card](#).
7. Remove the [assembly inner frame](#).

About this task

The following image indicates the location of the LED board and provides a visual representation of the removal procedure.



1x
M2x3

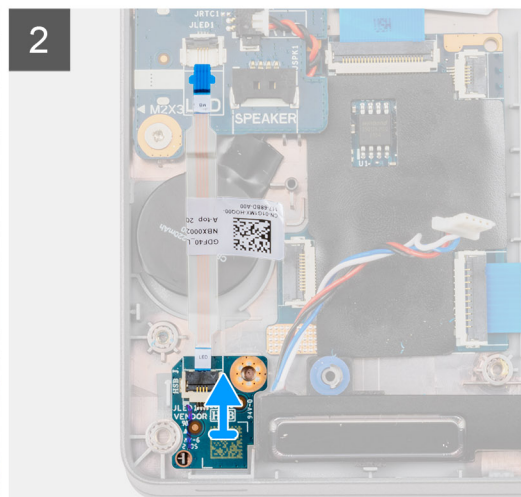
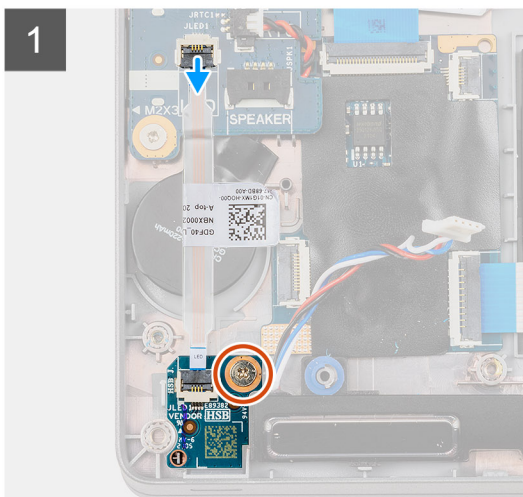
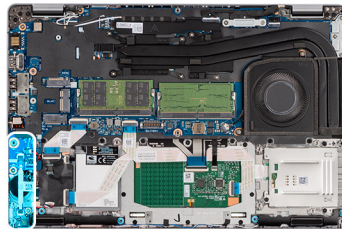

Steps

1. Disconnect the LED-board cable from the connector on the system board.
2. Peel the LED-board cable from the computer.
3. Remove the single screw (M2x3) that secures the LED board to the palm-rest assembly.
4. Lift the LED board and cable away from the palm-rest assembly.

Installing the LED board

Prerequisites

If you are replacing a component, remove the existing component before performing the installation procedure.

About this task

The following images indicate the location of the LED board and provide a visual representation of the installation procedure.



1x
M2x3

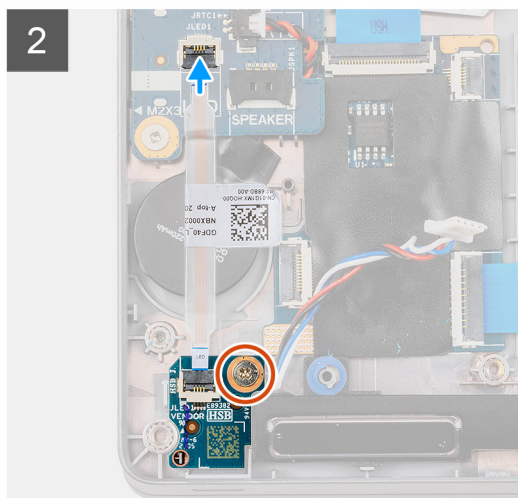
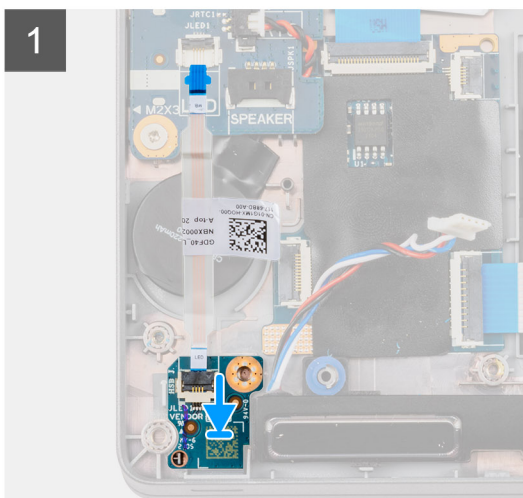
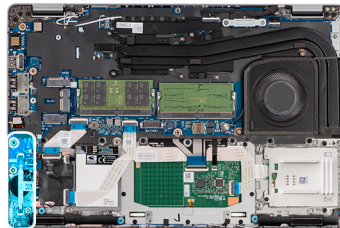

Steps

1. Align the screw hole on the LED board with the screw hole on the palm-rest assembly.
2. Replace the single screw (M2x3) to secure the LED board to the palm-rest assembly.
3. Route the LED-board cable and connect the cable to the connector on the system board.

CAUTION: Do not route the LED-board cable under the coin-cell battery. Incorrect routing of the LED-board cable may damage the LED board, LED-board cable, and system board.

Next steps

1. Install the [assembly inner frame](#).
2. Install the [battery](#).
3. Install the [wireless card](#).
4. Install the [2280 solid-state drive](#) or [2230 solid-state drive](#).
5. Install the [base cover](#).
6. Install the [microSD card](#).
7. Follow the procedure in [After working inside your computer](#).

Heat sink

Removing the heat sink and fan assembly - UMA

Prerequisites

1. Follow the procedure in [Before working inside your computer](#).
2. Remove the [microSD card](#).
3. Remove the [base cover](#).

About this task

The following images indicate the location of the heat sink and fan assembly and provide a visual representation of the removal procedure.

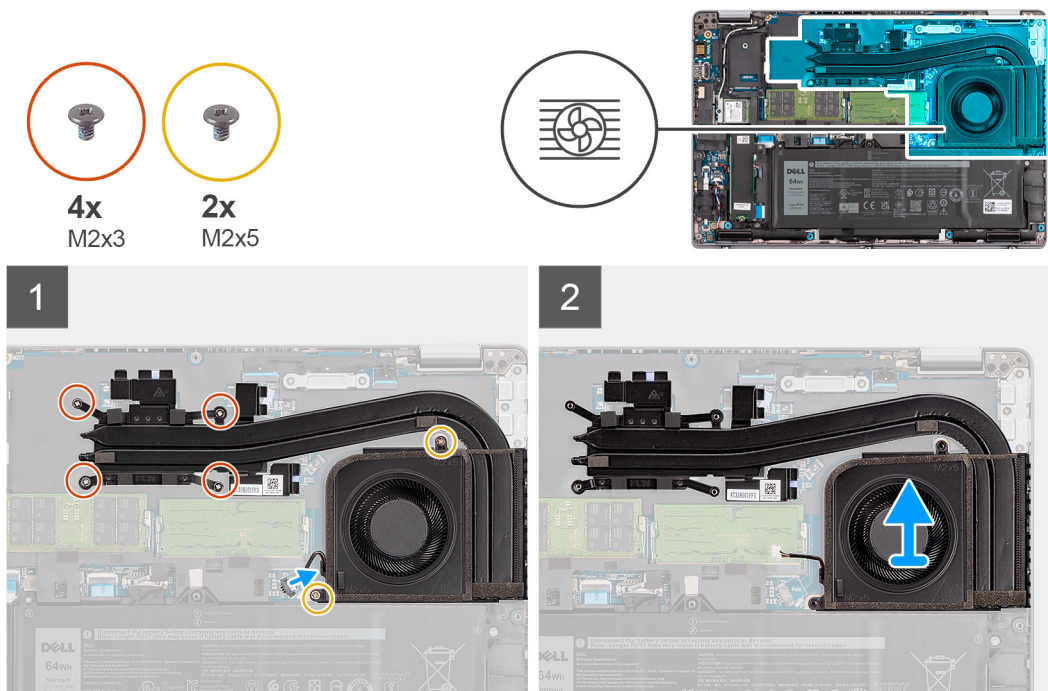

Steps

1. Disconnect the system fan cable from the connector on the system board.
2. Remove the two screws (M2x5) that secure the system fan to the system board.
3. In reverse sequential order (as indicated on the heat sink), loosen the four screws (M2x3) that secure the heat sink and fan assembly to the system board.
4. Lift the heat sink and fan assembly off the system board.

i **NOTE:** Do not damage the thermal fan sponge during any replacement procedures. Damaging this sponge reduces the effectiveness of the heat dispersion.

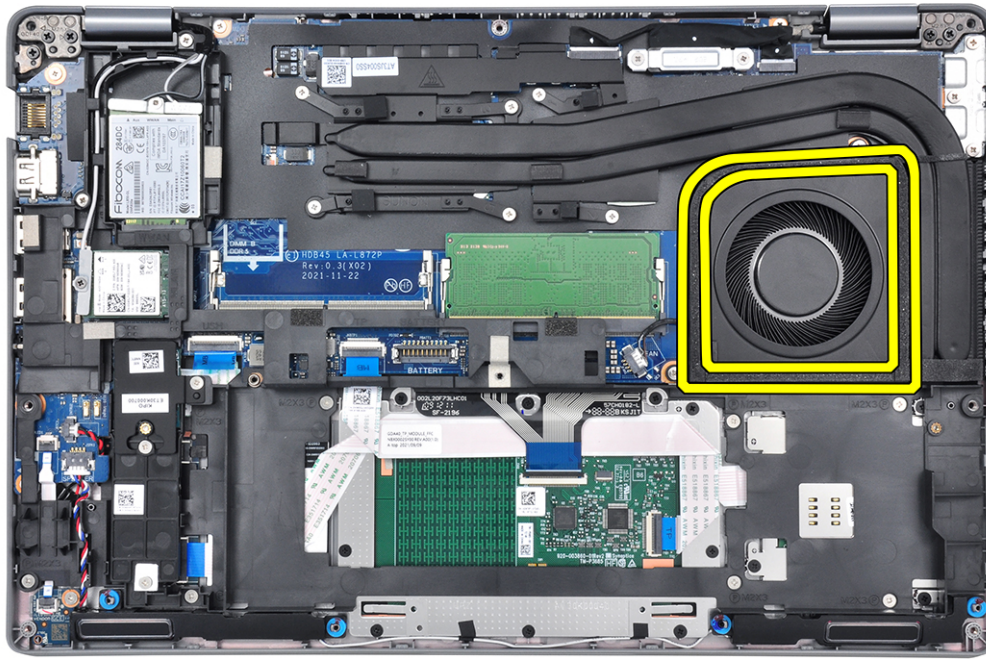

Installing the heat sink and fan assembly - UMA

Prerequisites

If you are replacing a component, remove the existing component before performing the installation procedure.

CAUTION: Incorrect alignment of the heat sink can damage the system board and processor.

NOTE: If either the system board or the heat sink is replaced, use the thermal pad/paste provided in the kit to ensure that thermal conductivity is achieved.

About this task

The following images indicate the location of the heat sink and fan assembly and provide a visual representation of the installation procedure.

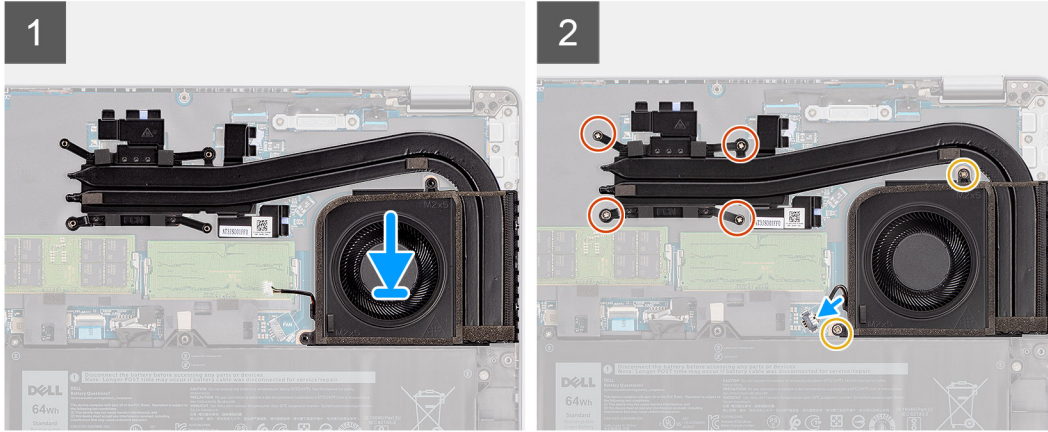
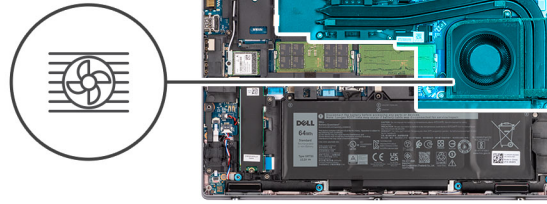
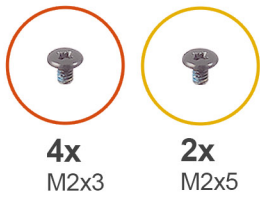

Steps

1. Align the screw holes on the heat sink and fan assembly with the screw holes on the system board.
2. In sequential order (as indicated on the heat sink), tighten the four screws (M2x3) that secure the heat sink and fan assembly to the system board.
3. Replace the two screws (M2x5) that secure the system fan to the frame.
4. Connect the system fan cable to the connector on the system board.

Next steps

1. Install the [base cover](#).
2. Install the [microSD card](#).
3. Follow the procedure in [After working inside your computer](#).

Speakers

Removing the speakers

Prerequisites

1. Follow the procedure in [Before working inside your computer](#).
2. Remove the [microSD card](#).
3. Remove the [base cover](#).
4. Remove the [battery](#).
5. Remove the [assembly inner frame](#).

About this task

The following image indicates the location of the speakers and provide a visual representation of the removal procedure.

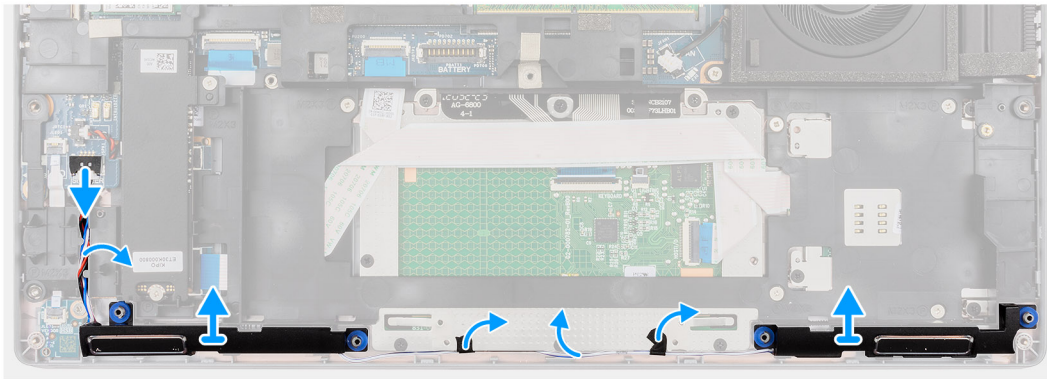
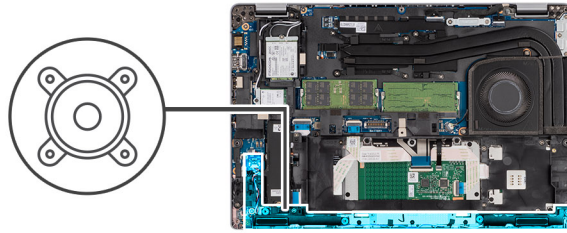

Steps

1. Disconnect the speaker cable from the connector on the system board.
2. Peel the tape that secures the speaker cable to the palm-rest and keyboard assembly.
3. Note the speaker cable routing, and unroute the speaker cable from the routing guides on the palm-rest and keyboard assembly.
4. Lift the speakers, along with the cable, off the palm-rest and keyboard assembly.

Installing the speakers

Prerequisites

If you are replacing a component, remove the existing component before performing the installation procedure.

About this task

The following image indicates the location of the speaker and provides a visual representation of the installation procedure.

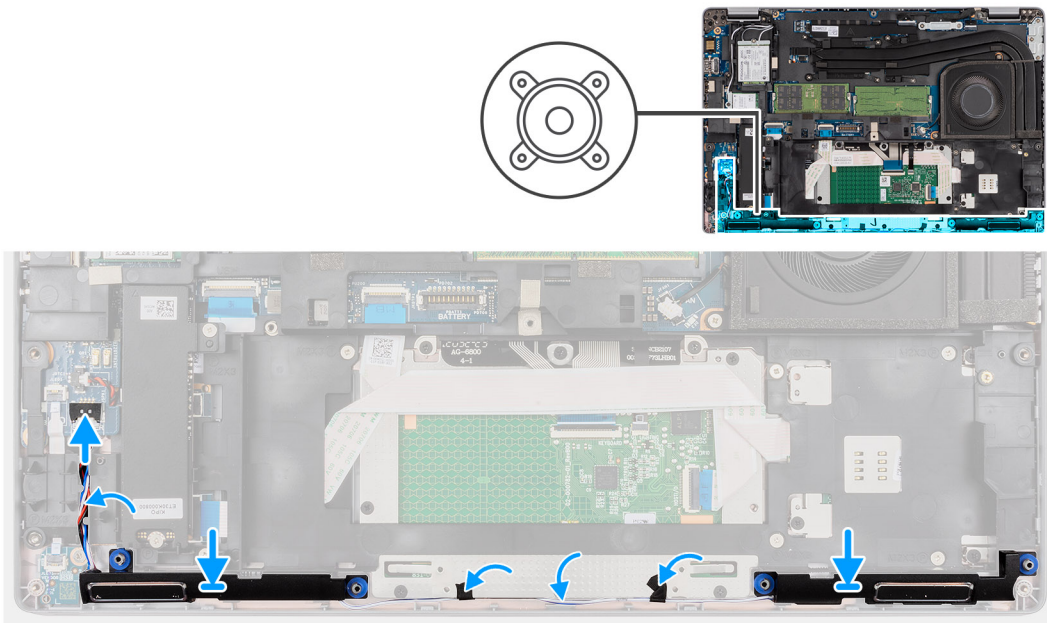

Steps

1. Using the alignment posts and rubber grommets, place the speakers on the slots of the palm-rest and keyboard assembly.

i NOTE: Replace the cushion rubbers if any one of the cushion rubber is separated from the speakers.

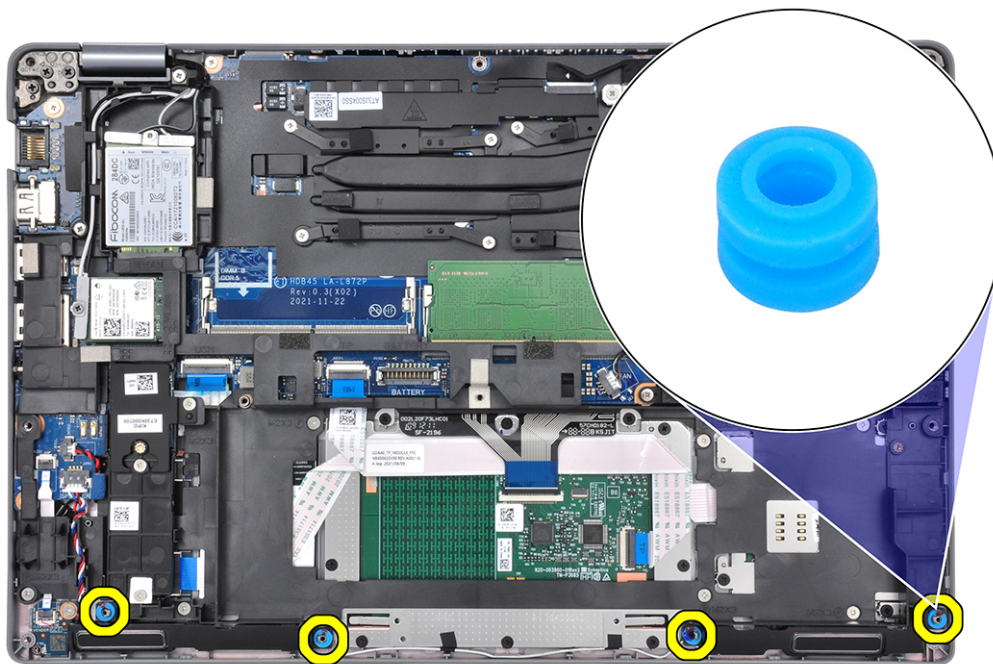

2. Route the speaker cable through the bottom-left corner of the system and ensure that the speaker cables are routed firmly into the routing guides on the palm-rest and keyboard assembly.
3. Connect the speaker cable to the connector on the system board.

i NOTE: When routing the speaker cable, route the cables into the channels on the inner frame.

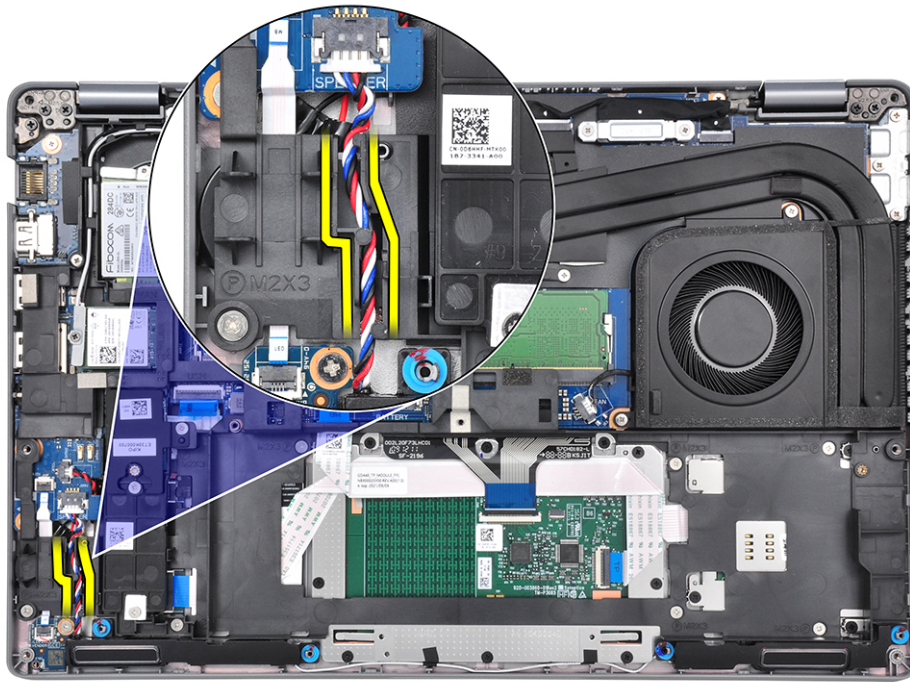

Next steps

1. Install the [assembly inner frame](#).
2. Install the [battery](#).
3. Install the [base cover](#).
4. Install the [microSD card](#).
5. Follow the procedure in [After working inside your computer](#).

System board

Removing the system board

Prerequisites

1. Follow the procedure in [Before working inside your computer](#).
2. Remove the [microSD card](#).
3. Remove the [base cover](#).
4. Remove the [2280 solid-state drive](#) or [2230 solid-state drive](#).
5. Remove the [battery](#).
6. Remove the [wireless card](#).
7. Remove the [assembly inner frame](#).
8. Remove the [heat sink](#).

About this task

The following image indicates the connectors on your system board.

Figure 1. System board connectors

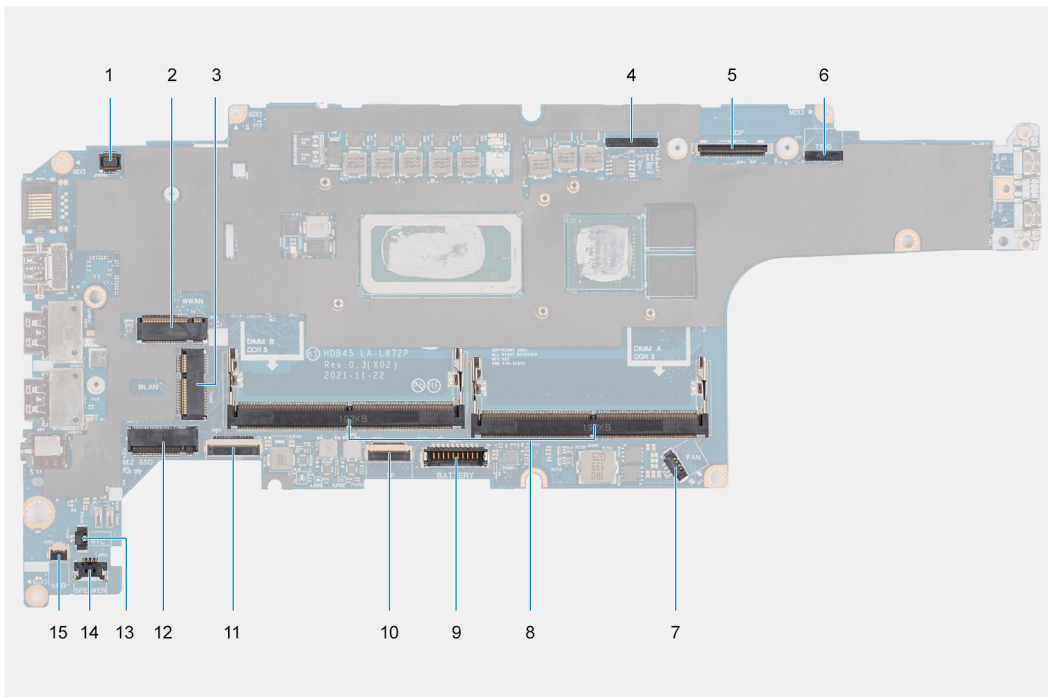

1. Fingerprint reader connector
2. WWAN connector
3. Camera/IR cable connector
4. eDP/display cable connector
5. Touch and sensor cable connector
6. Fan connector
7. Memory modules
8. Battery cable connector
9. Touchpad cable connector
10. USB board connector
11. WLAN connector
12. Solid-state drive slot
13. Coin-cell battery cable connector
14. Speaker cable connector
15. Battery LED cable connector

The following images indicate the location of the system board and provide a visual representation of the removal procedure.

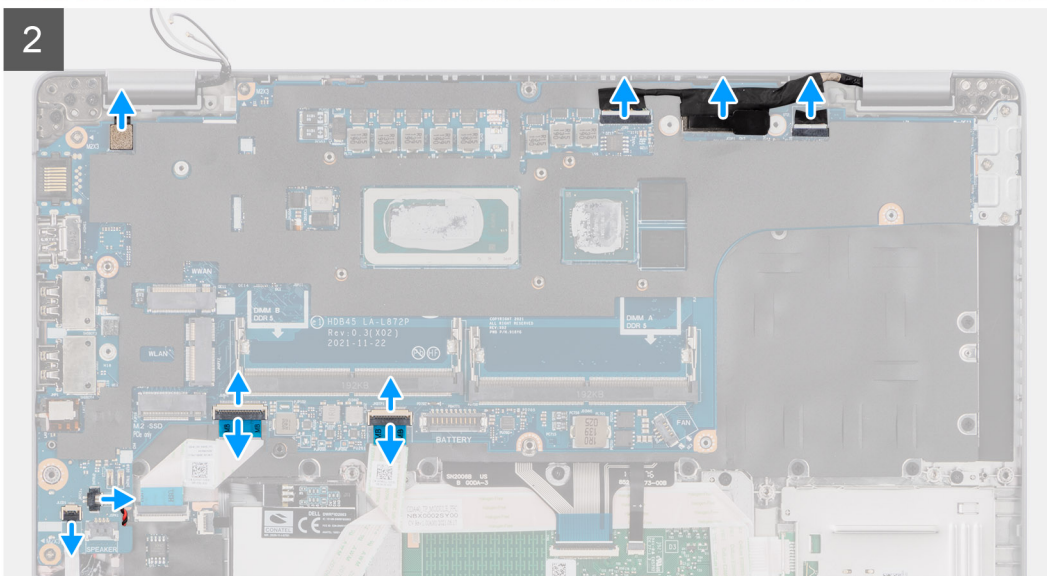
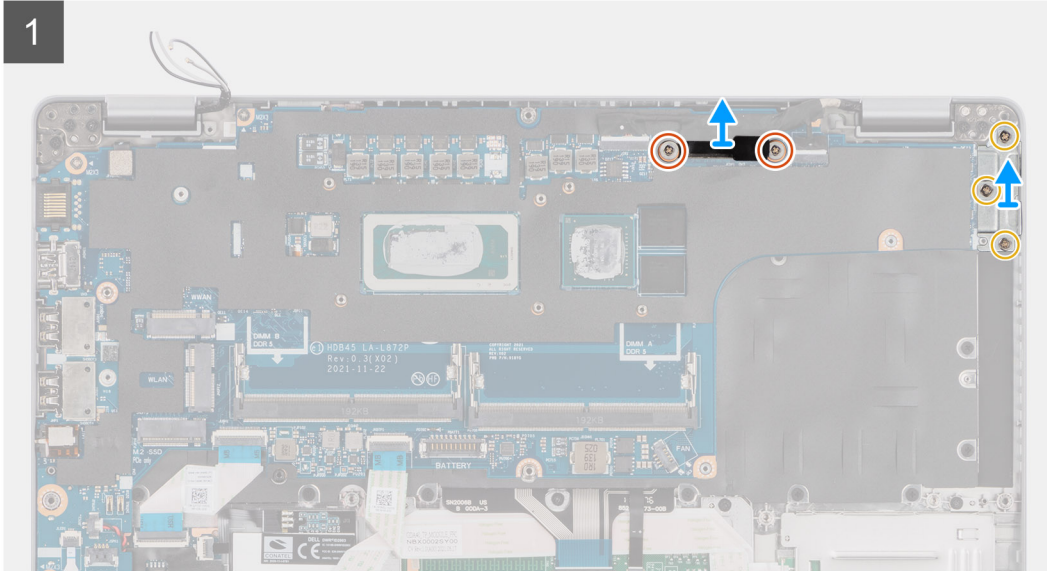
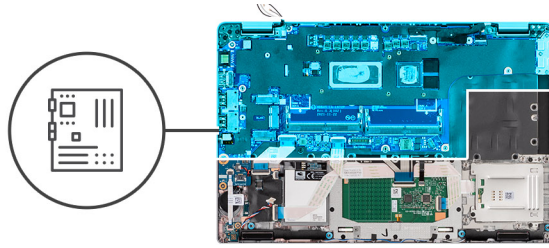

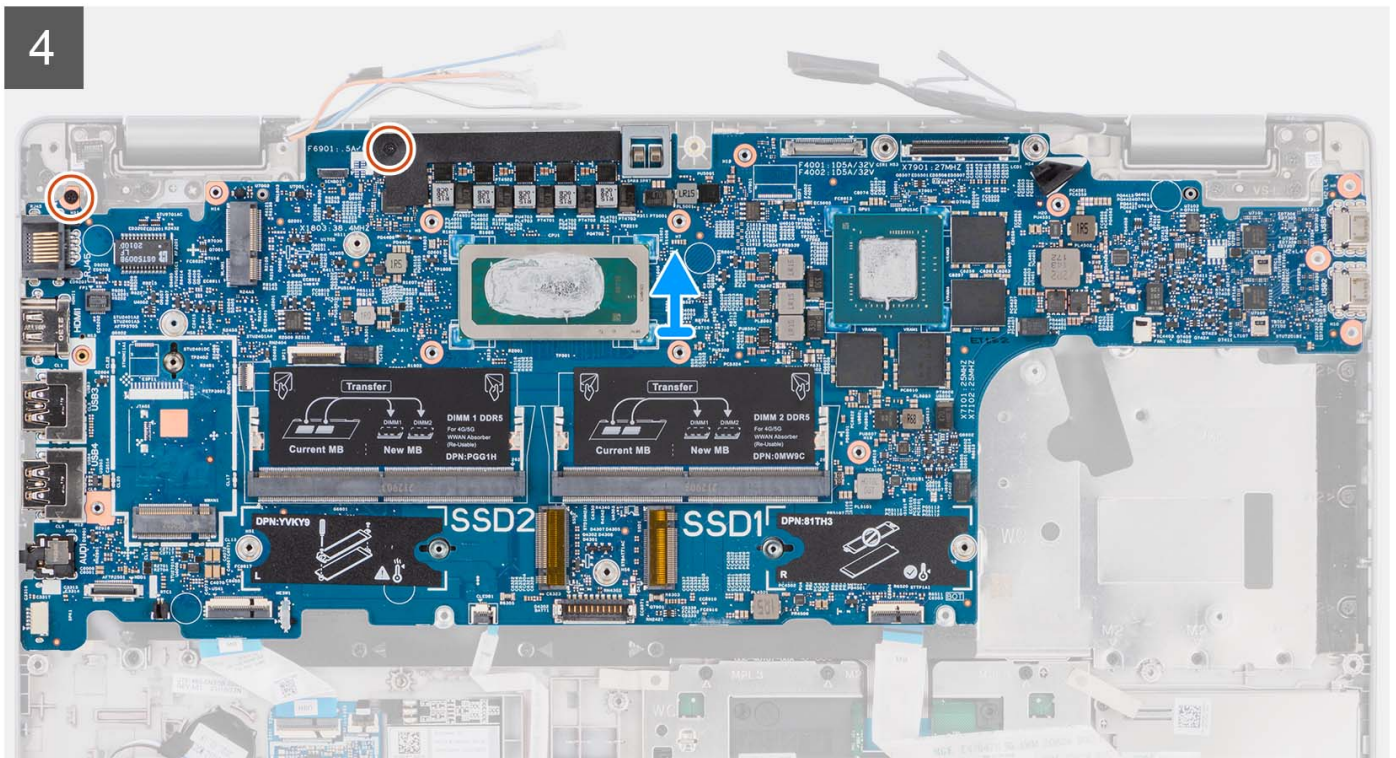
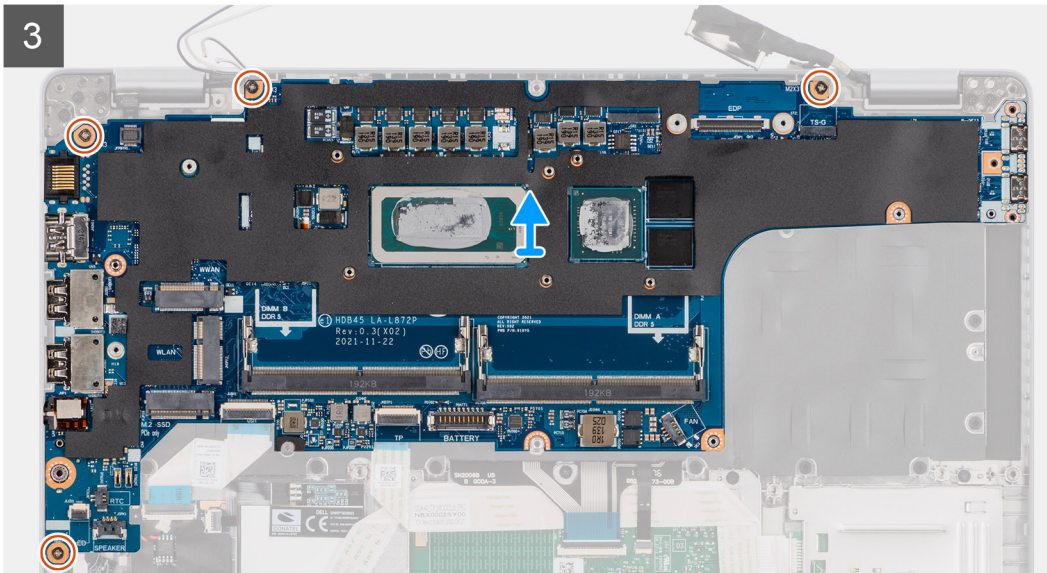

Steps

- i **NOTE:** For the models shipped with a fingerprint reader, disconnect the fingerprint reader cable from the connector on the system board before removing the system board from the palm-rest assembly and keyboard assembly.
- i **NOTE:** When removing the system board to replace/access other parts, the system board can be removed and installed with the thermal assembly attached to simplify the procedure and preserve the thermal bond between the system board and heat-sink. To do so, you must also remove the two (M2x5) screws securing the fan to the palm-rest assembly.

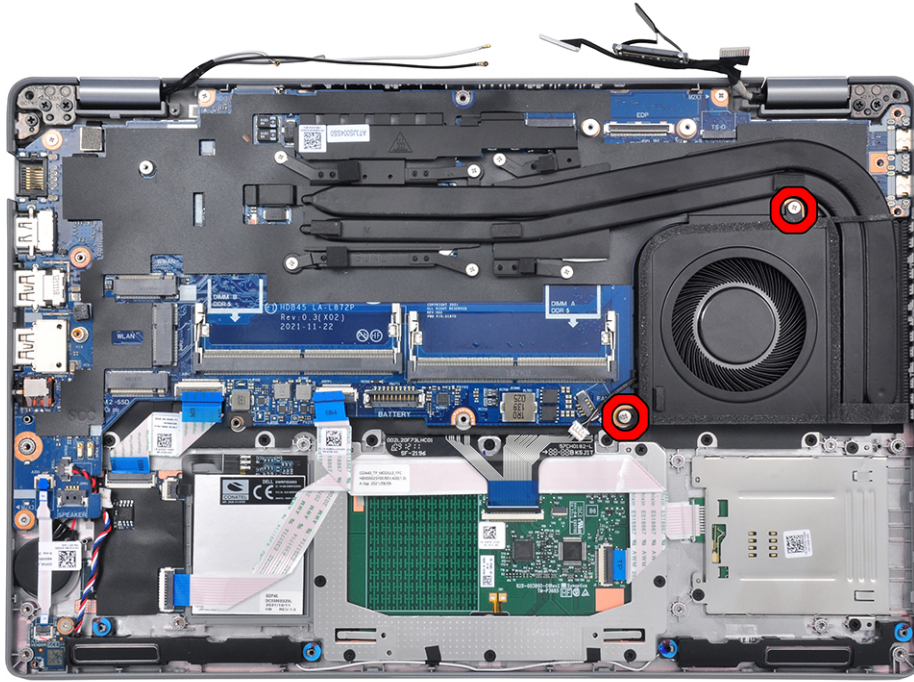

1. Remove the two (M2x3) screws that secure the eDP/display cable bracket to the system board.
2. Lift the eDP/display cable bracket away from the system.
3. Peel the tape that secures the display cable to the system board.
4. Using the pull tab, disconnect the display cable from the connector on the system board.
5. Disconnect IR camera cable from the connector on the system board (for models shipped with an IR camera).
6. Disconnect the touch screen cable from the connector on the system board (for models shipped with a touch screen).
7. Open the latch and disconnect the USH board cable from the connector on the system board.
8. Open the latch and disconnect the touchpad cable from the connector on the system board.
9. Open the latch and disconnect the LED cable from the connector on the system board.
10. Disconnect the coin-cell battery cable from the connector on the system board.
 - NOTE:** When you disconnect the coin-cell battery cable from the connector on the system board, the CMOS setting is cleared.
11. Remove the three (M2x5) screws that secure the USB Type-C bracket to the system board.
12. Lift off the USB Type-C bracket off the system board.
13. Remove the four (M2x3) screws that secure the system board to the palm-rest assembly and keyboard assembly.
14. Lift the system board off the palm-rest assembly and keyboard assembly.

Installing the system board

Prerequisites

If you are replacing a component, remove the existing component before performing the installation procedure.

About this task

The following images indicate the location of the system board and provide a visual representation of the installation procedure.



6x
M2x3

3x
M2x5

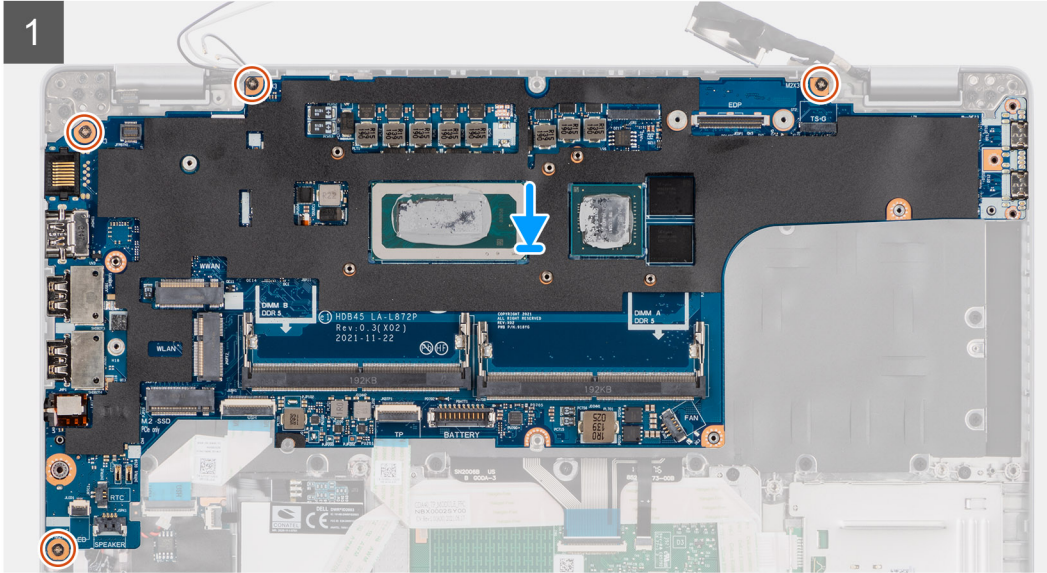
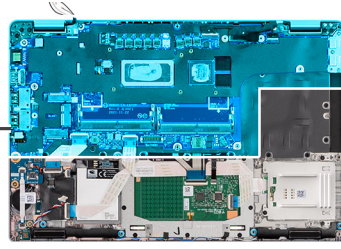

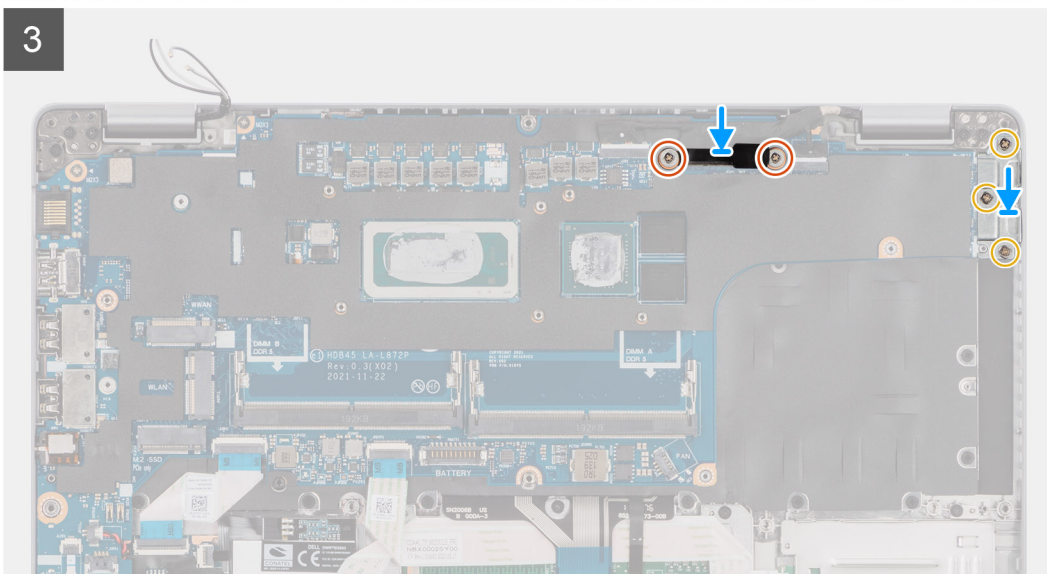
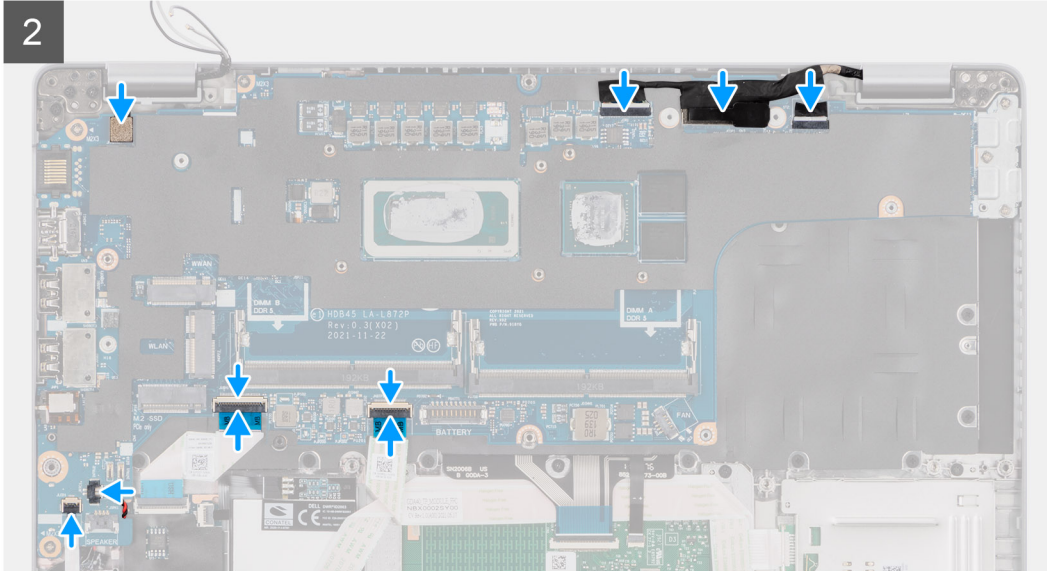
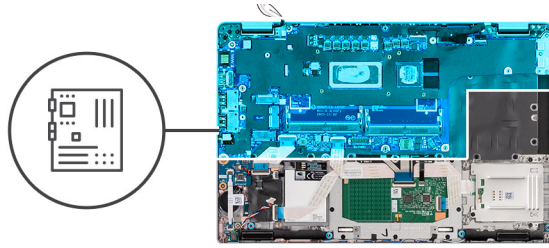

Steps

i **NOTE:** The system board can be removed and installed with the thermal module attached in order to simplify the procedure and preserve the thermal bond between the system board and heat-sink. In order to do so, technicians must also remove the two (M2x5) screws that secure the system fan to the system board.

1. Slide the system board to make the USB Type-C connector to toe-in to the hinge saddle and align the screw holes on the system board with the screw holes on the palm-rest assembly and keyboard assembly.
2. Replace the four (M2x3) screws to secure the system board to the palm-rest assembly and keyboard assembly.
3. Align and place the USB Type-C bracket on the system board.
4. Replace the three (M2x5) screws that secure the USB Type-C bracket to the system board.
5. Route the coin-cell battery cable under the system board and connect the coin-cell battery cable to the connector on the system board.

6. Connect the touchpad cable to the system board and close the latch to secure the cable to the system board.
7. Connect the USH board cable to the system board and close the latch to secure the cable to the system board.
8. Connect the touch screen cable from the connector on the system board (for models shipped with a touch screen).
9. Connect IR camera cable from the connector on the system board (for models shipped with an IR camera).
10. Route the display and eDP/display cable through the routing guide on the system board.
11. Connect the eDP/display cable to the connector on the system board.
12. Connect the display cable to the connector on the system board.
13. Adhere the tape that secures the display cable to the system board.
14. Align the screw holes on the eDP/display cable bracket with the screw holes on the system board.
15. Replace the two (M2x3) screws that secure the eDP/display cable bracket to the system board.

Next steps

1. Install the [heat sink](#).
2. Install the [assembly inner frame](#).
3. Install the [battery](#).
4. Install the [wireless card](#).
5. Install the [2280 solid-state drive](#) or [2230 solid-state drive](#).
6. Install the [base cover](#).
7. Install the [microSD card](#).
8. Follow the procedure in [After working inside your computer](#).

Power button with fingerprint reader

Removing the power button

Prerequisites

1. Follow the procedure in [Before working inside your computer](#).
2. Remove the [microSD card](#).
3. Remove the [base cover](#).
4. Remove the [2280 solid-state drive](#) or [2230 solid-state drive](#).
5. Remove the [memory modules](#).
6. Remove the [battery](#).
7. Remove the [wireless card](#).
8. Remove the heat sink [heat sink](#).
9. Remove the [assembly inner frame](#).
10. Remove the [system board](#).

 **NOTE:** The system board can be removed with the heat sink attached in order to simplify the procedure and preserve the thermal bond between the system board and heat sink.

About this task

The following image indicates the location of the power-button board and provide a visual representation of the removal procedure.



2x
M2x2.5

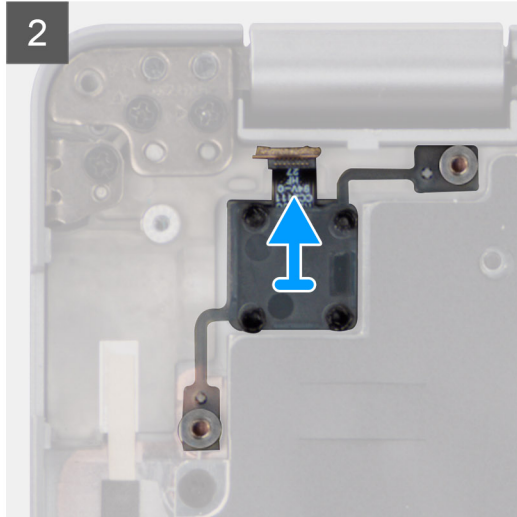
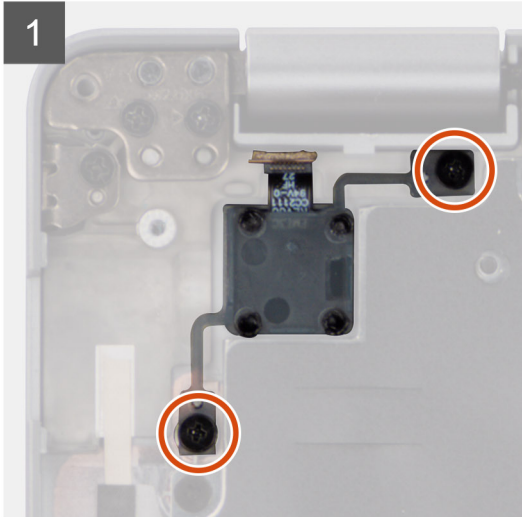
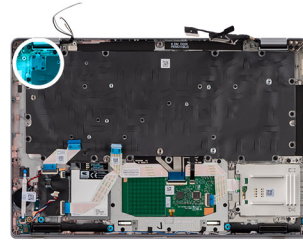

Steps

1. Remove the two screws (M2x2.5) that secure the power-button board to the palm-rest assembly.

i **NOTE:** The removal of two screws applies to both models with and without the fingerprint reader.

2. Lift the power-button board off the palm-rest assembly.

For models shipped with a fingerprint reader, make sure to disconnect the fingerprint reader FPC from the system board before removing the system board.

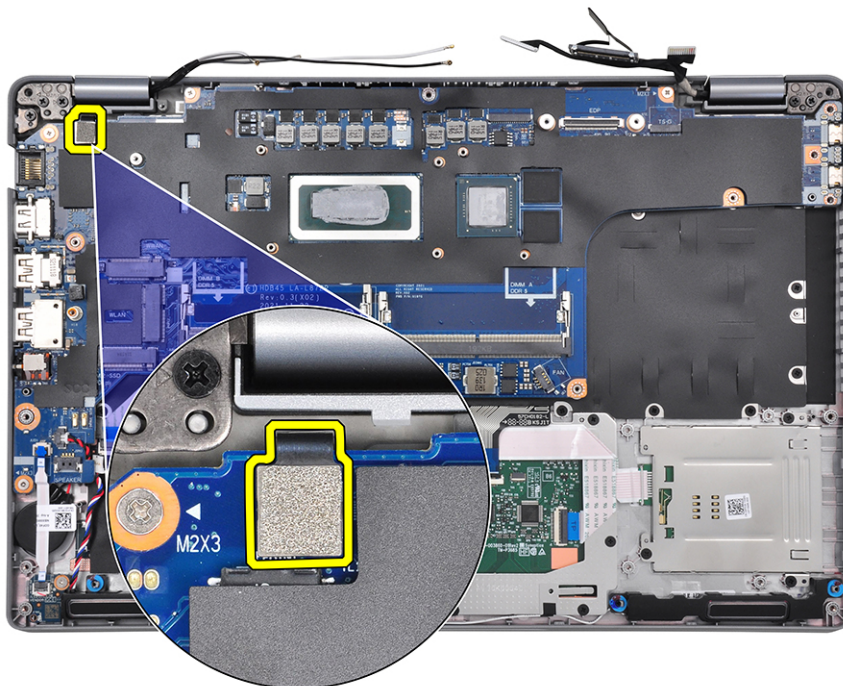

Installing the power button

About this task

The following image indicates the location of the power-button board and provide a visual representation of the installation procedure.



2x
M2x2.5

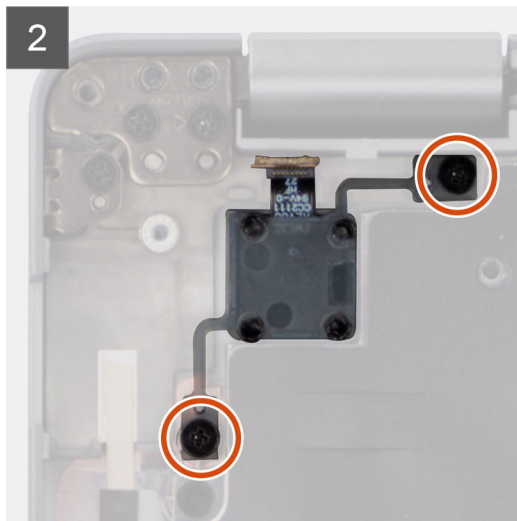
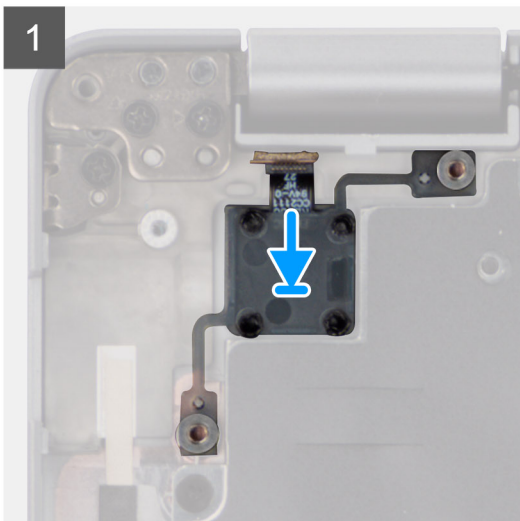
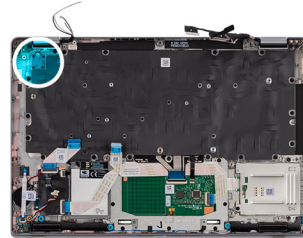

Steps

1. Align and place the power-button board on the palm-rest assembly.
2. Replace the two (M2x2.5) screws that secure the power-button board to the palm-rest assembly.

 **NOTE:** This step applies to both models with and without the fingerprint reader.

Next steps

1. Install the [system board](#).
2. Install the [heat sink](#).
3. Install the [assembly inner frame](#).
4. Install the [battery](#).
5. Install the [memory modules](#).
6. Install the [wireless card](#).
7. Install the [2280 solid-state drive](#) or [2230 solid-state drive](#).
8. Install the [base cover](#).
9. Install the [microSD card](#).
10. Follow the procedure in [After working inside your computer](#).

Smart card reader

Removing the smart card reader

Prerequisites

1. Follow the procedure in [Before working inside your computer](#).
2. Remove the [microSD card](#).
3. Remove the [base cover](#).
4. Remove the [2280 solid-state drive](#) or [2230 solid-state drive](#).
5. Remove the [battery](#).
6. Remove the [wireless card](#).
7. Remove the [assembly inner frame](#).

About this task

The following images indicate the location of the smart card reader and provide a visual representation of the removal procedure.



3x
M2x2.5

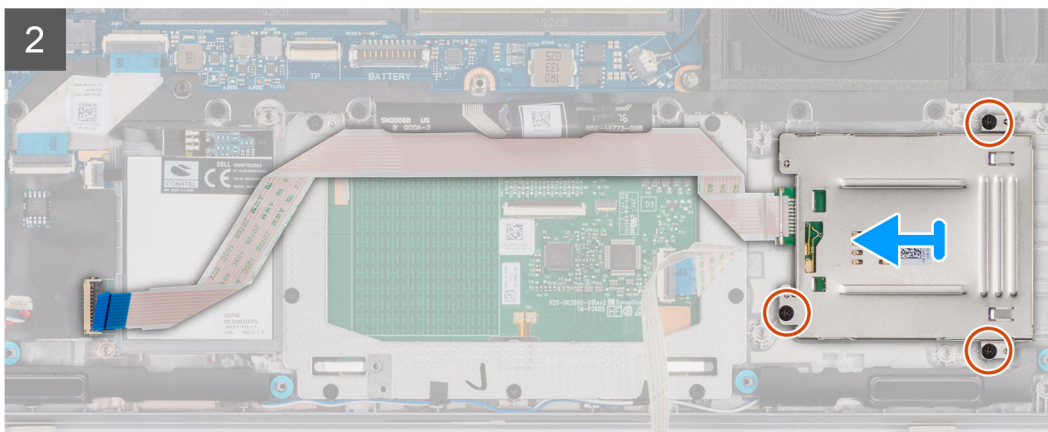
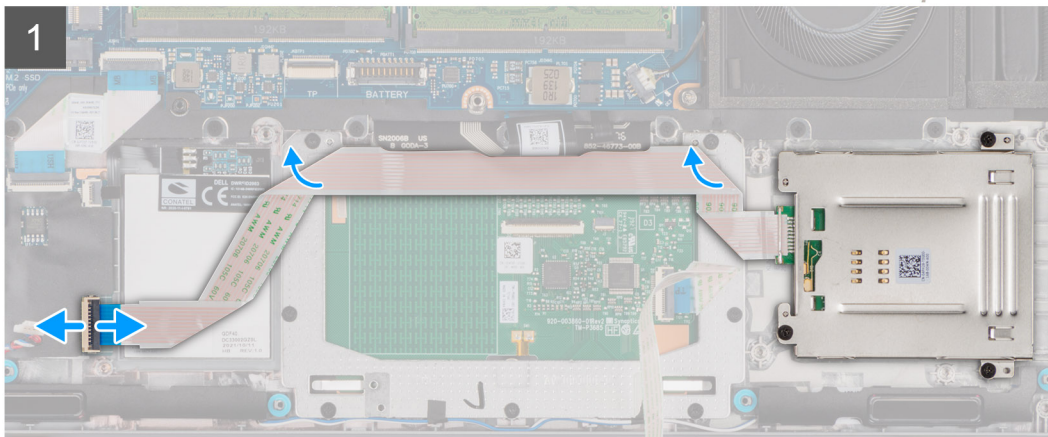
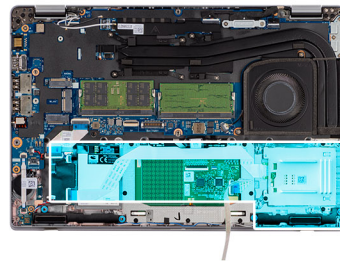

Steps

1. Open the latch and disconnect the smart card reader cable from the connector on the USH board.
2. Remove the three screws (M2x2.5) that secure the smart card reader to the palm-rest assembly.
3. Lift the smart card reader off the palm-rest assembly.

Installing the smart card reader

Prerequisites

If you are replacing a component, remove the existing component before performing the installation procedure.

About this task

The following images indicate the location of the smart card reader and provide a visual representation of the installation procedure.



3x
M2x2.5

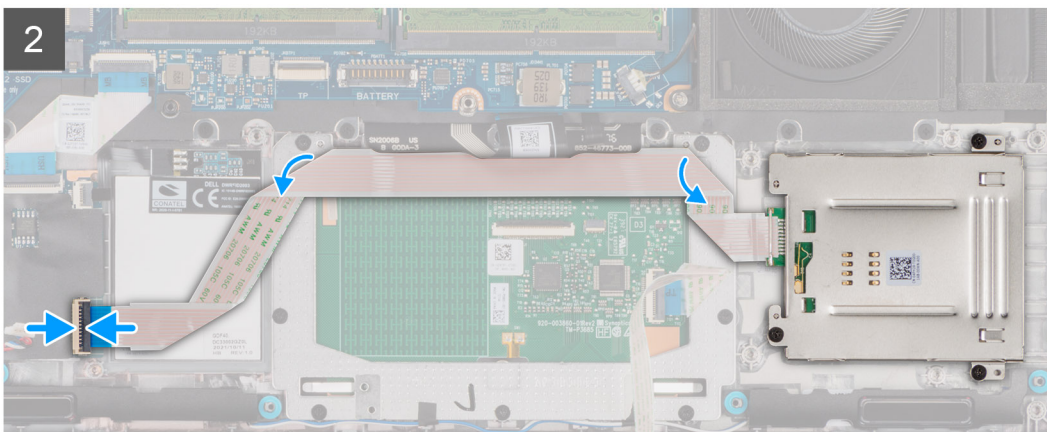
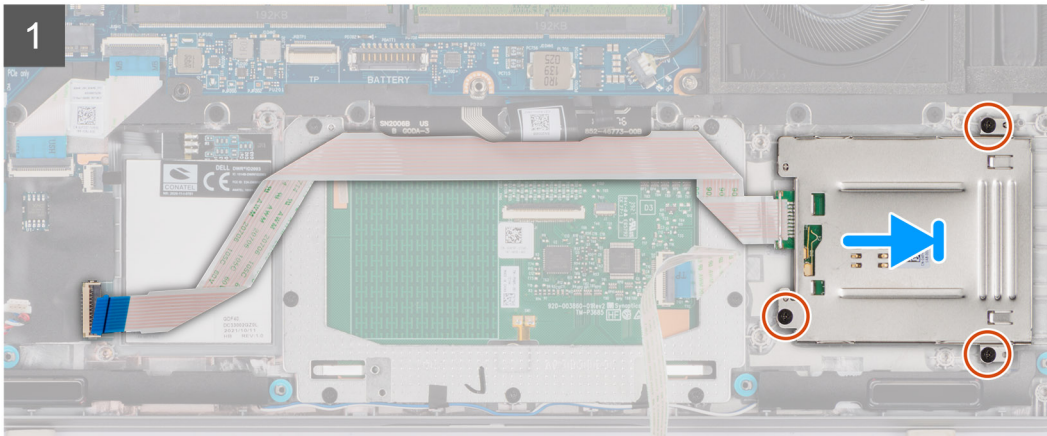
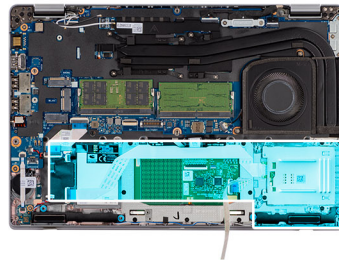

Steps

1. Align and place the smart card reader on the palm-rest assembly.
2. Replace the three screws (M2x2.5) that secure the smart card reader to the palm-rest assembly.
3. Connect the smart card reader cable to the connector on the USH board.

Next steps

1. Install the [assembly inner frame](#).
2. Install the [battery](#).
3. Install the [wireless card](#).
4. Install the [2280 solid-state drive](#) or [2230 solid-state drive](#).
5. Install the [base cover](#).
6. Install the [microSD card](#).
7. Follow the procedure in [After working inside your computer](#).

Coin-cell battery

Removing the coin-cell battery

Prerequisites

1. Follow the procedure in [Before working inside your computer](#).

 **CAUTION:** Removing the coin-cell battery resets the BIOS setup program's settings to default. It is recommended that you note the BIOS setup program's settings before removing the coin-cell battery.

2. Remove the [microSD card](#).
3. Remove the [base cover](#).
4. Remove the [2280 solid-state drive](#) or [2230 solid-state drive](#).
5. Remove the [battery](#).
6. Remove the [wireless card](#).
7. Remove the [assembly inner frame](#).

About this task

The following image indicates the location of the coin-cell battery and provides a visual representation of the removal procedure.

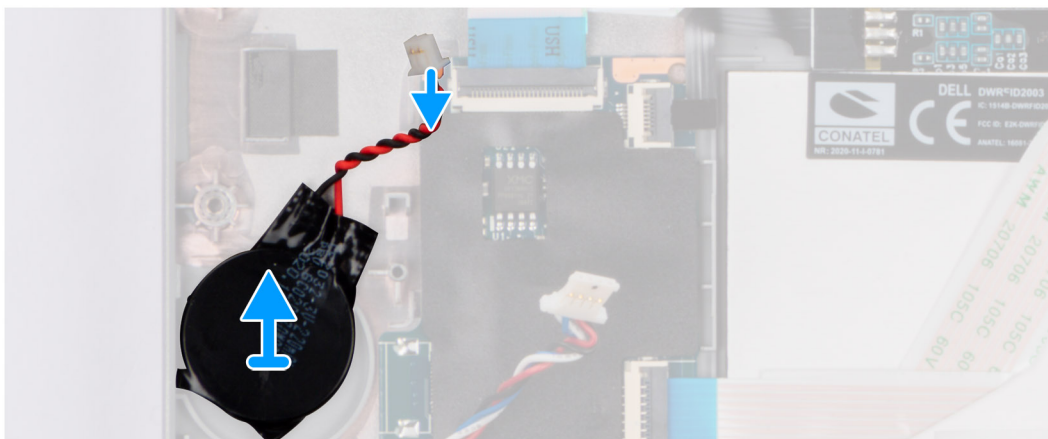
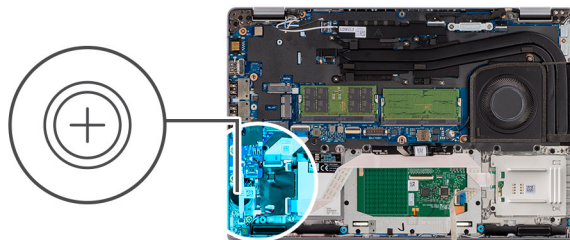

Steps

Pry and remove the coin-cell battery from the palm-rest assembly.

Installing the coin-cell battery

Prerequisites

If you are replacing a component, remove the existing component before performing the installation procedure.

About this task

The following image indicates the location of the coin-cell battery and provides a visual representation of the installation procedure.

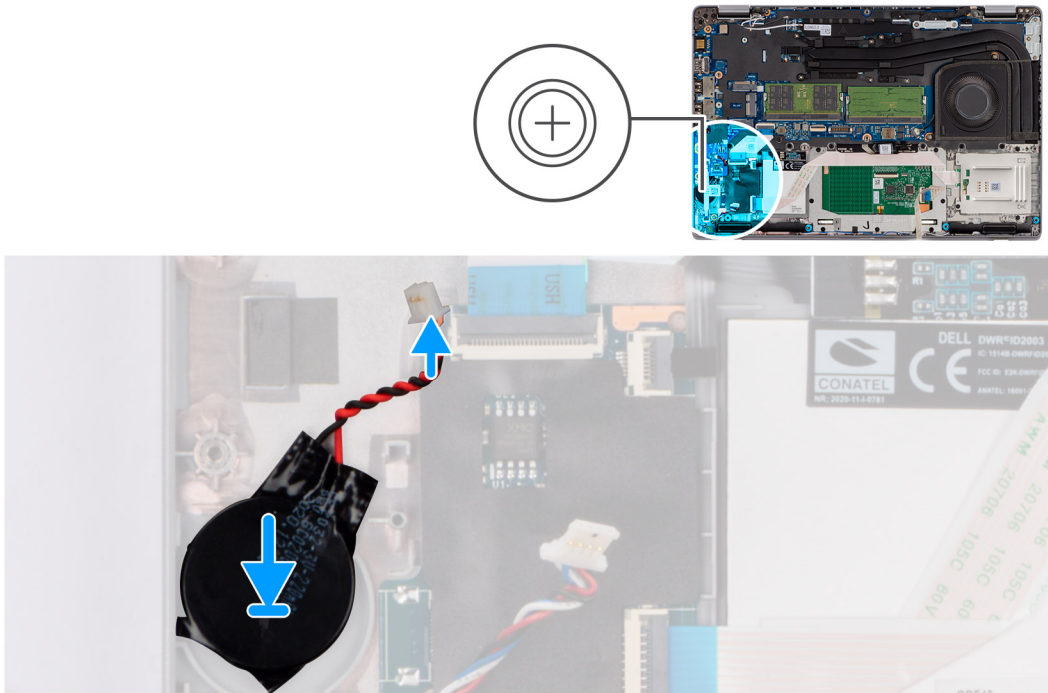

Steps

Adhere the coin-cell battery to the slot on the palm-rest assembly.

Next steps

1. Install the [assembly inner frame](#).
2. Install the [battery](#).
3. Install the [wireless card](#).
4. Install the [2280 solid-state drive](#) or [2230 solid-state drive](#).
5. Install the [base cover](#).
6. Install the [microSD card](#).
7. Follow the procedure in [After working inside your computer](#).

Keyboard assembly

Removing the keyboard assembly

Prerequisites

1. Follow the procedure in [Before working inside your computer](#).
2. Remove the [microSD card](#).
3. Remove the [base cover](#).

4. Remove the 2280 solid-state drive or 2230 solid-state drive.
5. Remove the battery.
6. Remove the wireless card.
7. Remove the heat sink heat sink.
8. Remove the assembly inner frame.
9. Remove the system board.

NOTE: The system board can be removed with the heat sink attached in order to simplify the procedure and preserve the thermal bond between the system board and heat sink.

About this task

The following images indicate the location of the keyboard assembly and provide a visual representation of the removal procedure.



16x
M2x2

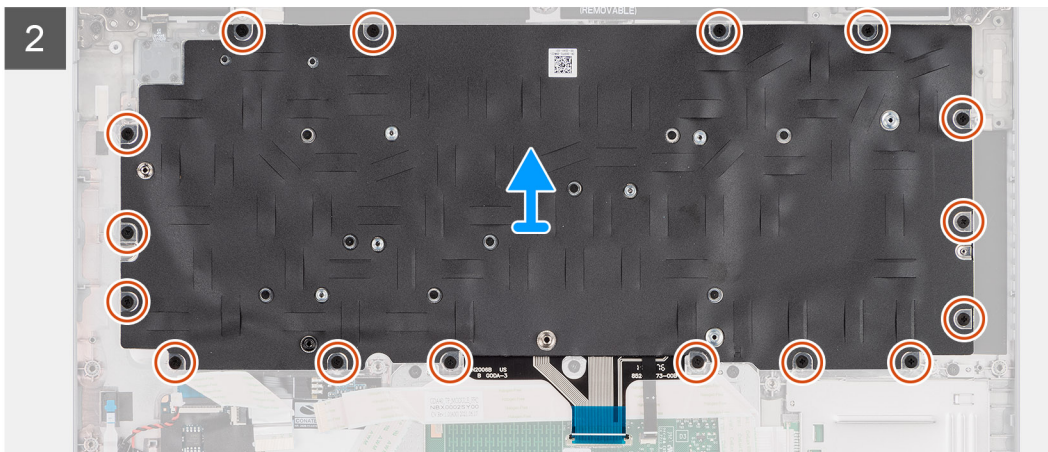
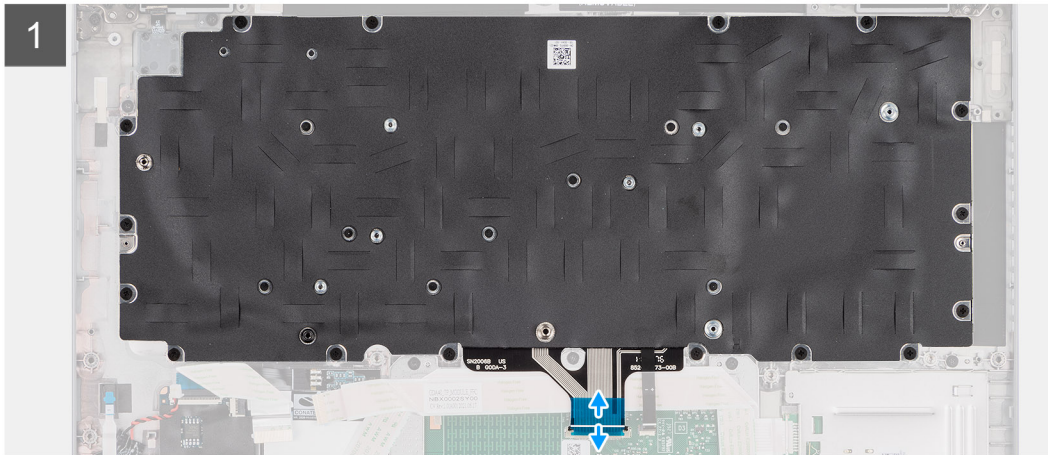
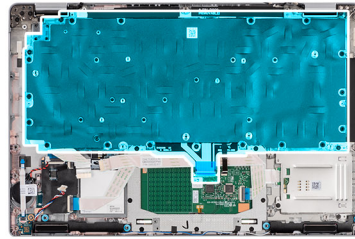

Steps

1. **NOTE:** For models shipped with a USH module, disconnect the USH cable from the keyboard bracket.
Lift the latch and disconnect the keyboard cable and keyboard backlit cable (for models that are shipped with the keyboard backlight) from the touchpad.
2. Remove the sixteen (M2x2) screws that secure the keyboard assembly to the palm-rest.

- Carefully lift the keyboard assembly from the palm-rest.
- Remove the keyboard assembly off the palm-rest assembly.

Installing the keyboard assembly

Prerequisites

If you are replacing a component, remove the existing component before performing the installation procedure.

About this task

NOTE: The system board can be installed with the heat sink attached in order to simplify the procedure and preserve the thermal bond between the system board and heat sink.

The following images indicate the location of the keyboard assembly and provide a visual representation of the installation procedure.



16x
M2x2

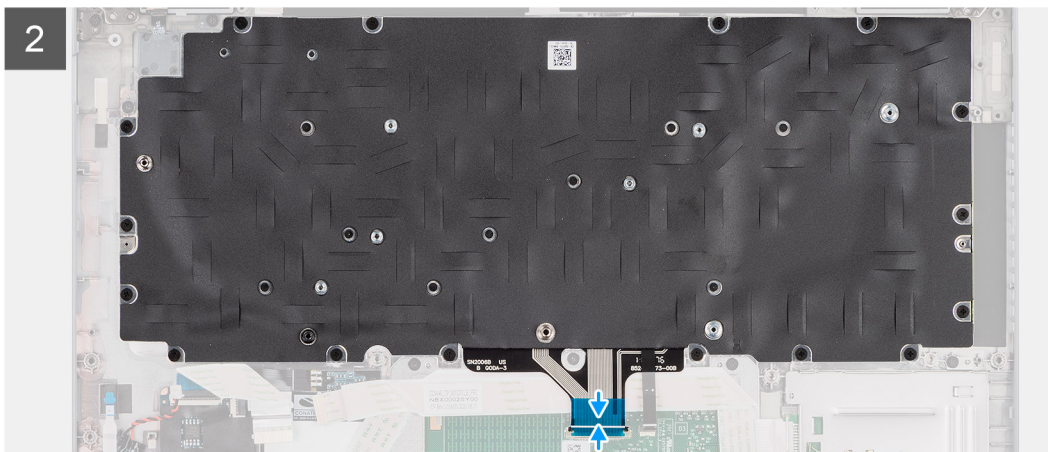
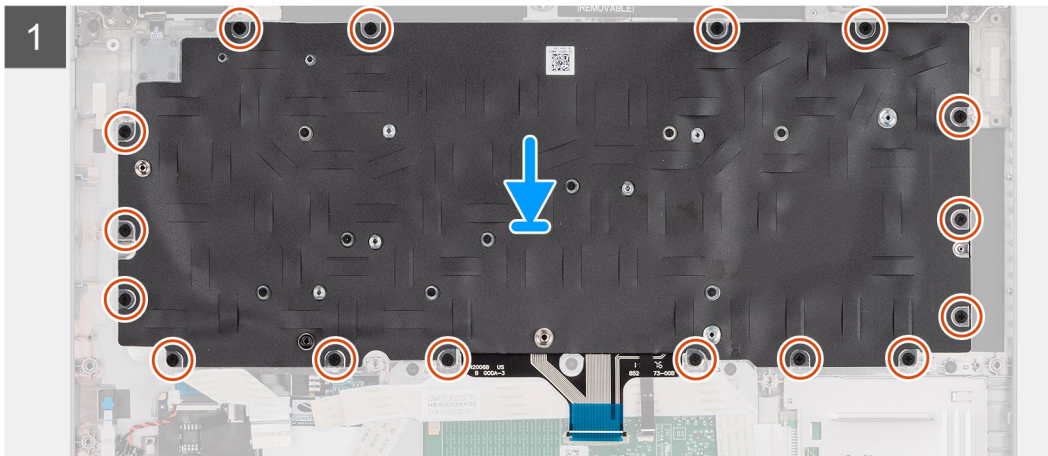
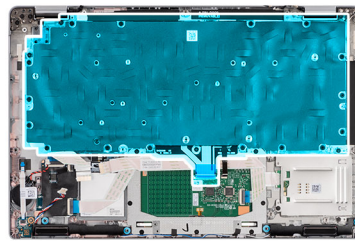

Steps

- Align and place the keyboard assembly on the palm-rest assembly.
- Replace the sixteen (M2x2) screws that secure the keyboard assembly to the palm-rest.

3. Connect the keyboard cable and keyboard backlit cable to its connectors on the touchpad.

 **NOTE:** For models shipped with a USH module, connect the USH cable to the keyboard bracket.

Next steps

1. Install the [system board](#).
2. Install the [heat sink](#).
3. Install the [assembly inner frame](#).
4. Install the [battery](#).
5. Install the [wireless card](#).
6. Install the [2280 solid-state drive](#) or [2230 solid-state drive](#).
7. Install the [base cover](#).
8. Install the [microSD card](#).
9. Follow the procedure in [After working inside your computer](#).

Keyboard bracket

Removing the keyboard bracket

Prerequisites

1. Follow the procedure in [Before working inside your computer](#).
2. Remove the [microSD card](#).
3. Remove the [base cover](#).
4. Remove the [2280 solid-state drive](#) or [2230 solid-state drive](#).
5. Remove the [memory modules](#).
6. Remove the [battery](#).
7. Remove the [wireless card](#).
8. Remove the heat sink [heat sink](#).
9. Remove the [assembly inner frame](#).
10. Remove the [system board](#).

 **NOTE:** The system board can be removed with the heat sink attached in order to simplify the procedure and preserve the thermal bond between the system board and heat sink.

11. Remove the [Keyboard assembly](#).

About this task

The following images indicate the location of the keyboard bracket and provide a visual representation of the removal procedure.



5x
M2x2



Steps

1. Remove the five (M2x2) screws that secure the keyboard to the keyboard bracket.
2. Remove the keyboard from the keyboard bracket.

Installing the keyboard bracket

Prerequisites

If you are replacing a component, remove the existing component before performing the installation procedure.

About this task

NOTE: The system board can be installed with the heat sink attached in order to simplify the procedure and preserve the thermal bond between the system board and heat sink.

The following image indicates the location of the keyboard bracket and provides a visual representation of the installation procedure.



5x
M2x2



3



Steps

1. Align and place the keyboard on the keyboard bracket.
2. Replace the five (M2x2) screws to secure the keyboard to the keyboard bracket.

Next steps

1. Install the [keyboard assembly](#).
2. Install the [system board](#).
3. Install the [heat sink](#).
4. Install the [assembly inner frame](#).
5. Install the [battery](#).
6. Install the [memory modules](#).
7. Install the [wireless card](#).
8. Install the [2280 solid-state drive](#) or [2230 solid-state drive](#).
9. Install the [base cover](#).
10. Install the [microSD card](#).
11. Follow the procedure in [After working inside your computer](#).

Display assembly

Removing the display assembly

Prerequisites

1. Follow the procedure in [Before working inside your computer](#).
2. Remove the [microSD card](#).
3. Remove the [base cover](#).
4. Remove the [wireless card](#).

About this task

The following images indicate the location of the display assembly and provide a visual representation of the removal procedure.



2x
M2x3



4x
M2.5x5

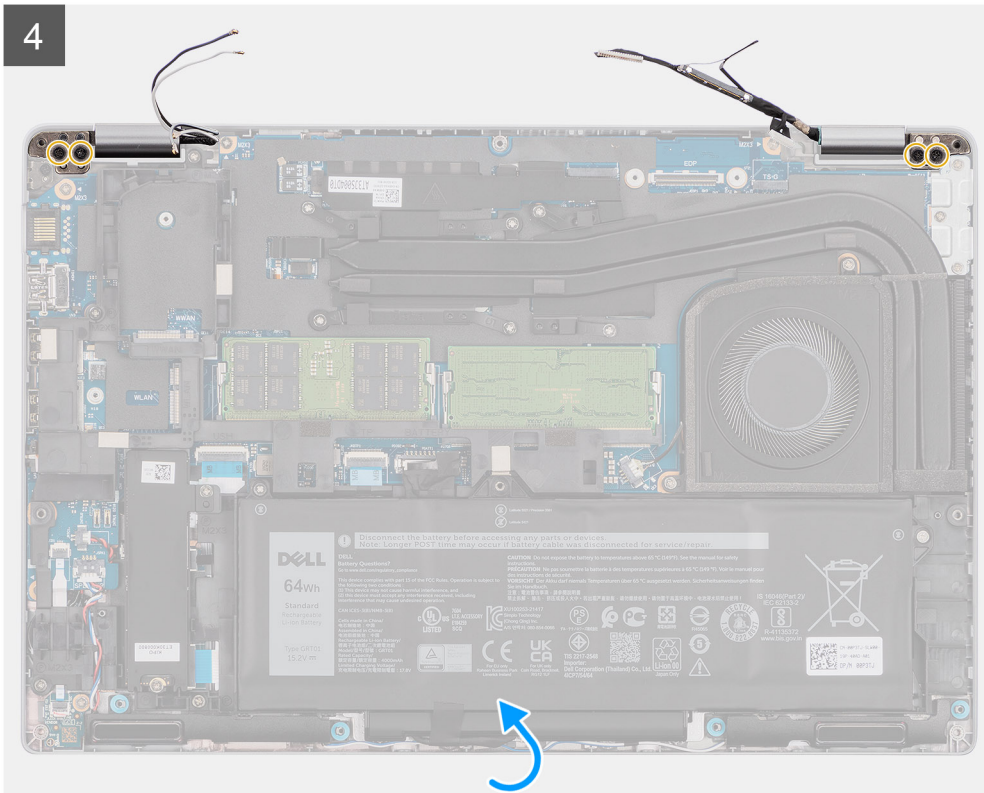
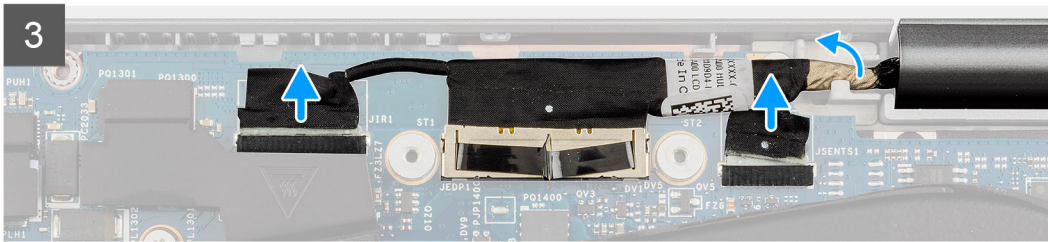
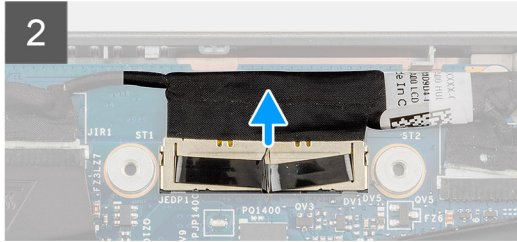
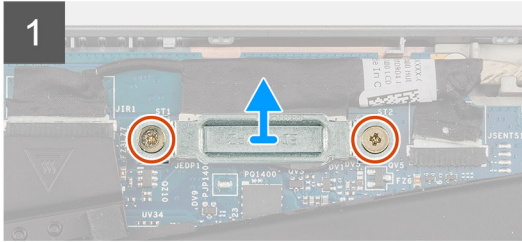
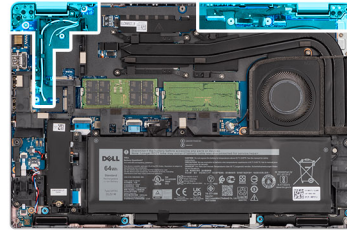

5



Steps

1. Remove the two (M2x3) screws that secure the eDP cable bracket to the system board.
2. Lift the eDP cable bracket away from the system.
3. Peel the tape that secures the display cable to the system board.
4. Using the pull tab, disconnect the display cable from the connector on the system board.

5. Disconnect the eDP cable from the connector on the system board and unroute it from the routing guide.
6. Disconnect the IR camera cable from its connector on the system board (for models shipped with an IR camera).
7. Disconnect the touchscreen cable from its connector on the system board (for models shipped with a touchscreen).
8. Peel the adhesive tape partially and unroute the WLAN antenna cables from the routing guides on the system board.
9. Remove the four (M2.5x5) screws that secure the display hinges to the system board.
10. Open the display hinges at an angle of 90 degrees.
11. Remove the display assembly from the system.

Installing the display assembly

Prerequisites

If you are replacing a component, remove the existing component before performing the installation procedure.

About this task

The following images indicate the location of the display assembly and provide a visual representation of the installation procedure.





2x
M2x3



4x
M2.5x5

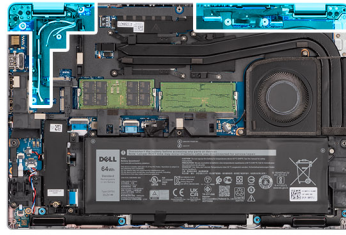

1

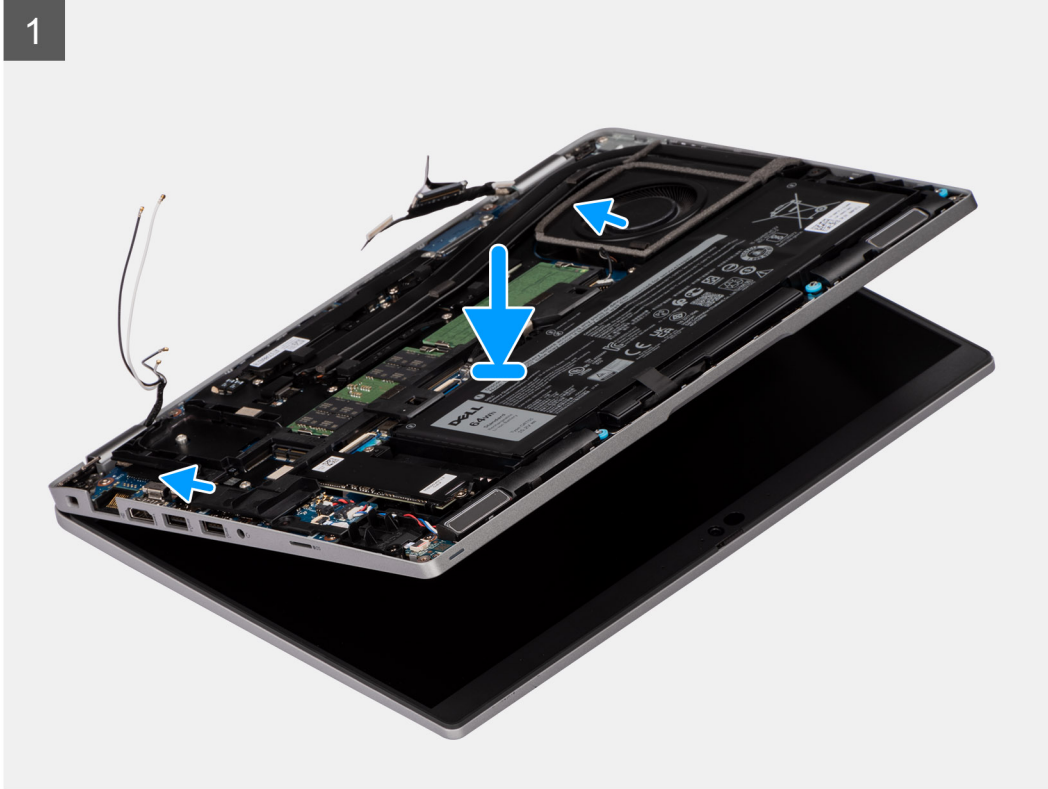

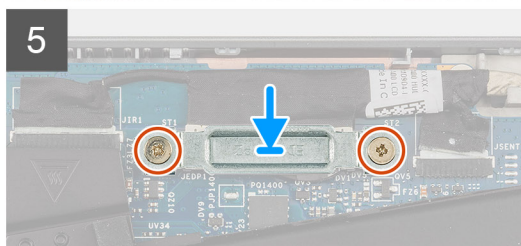
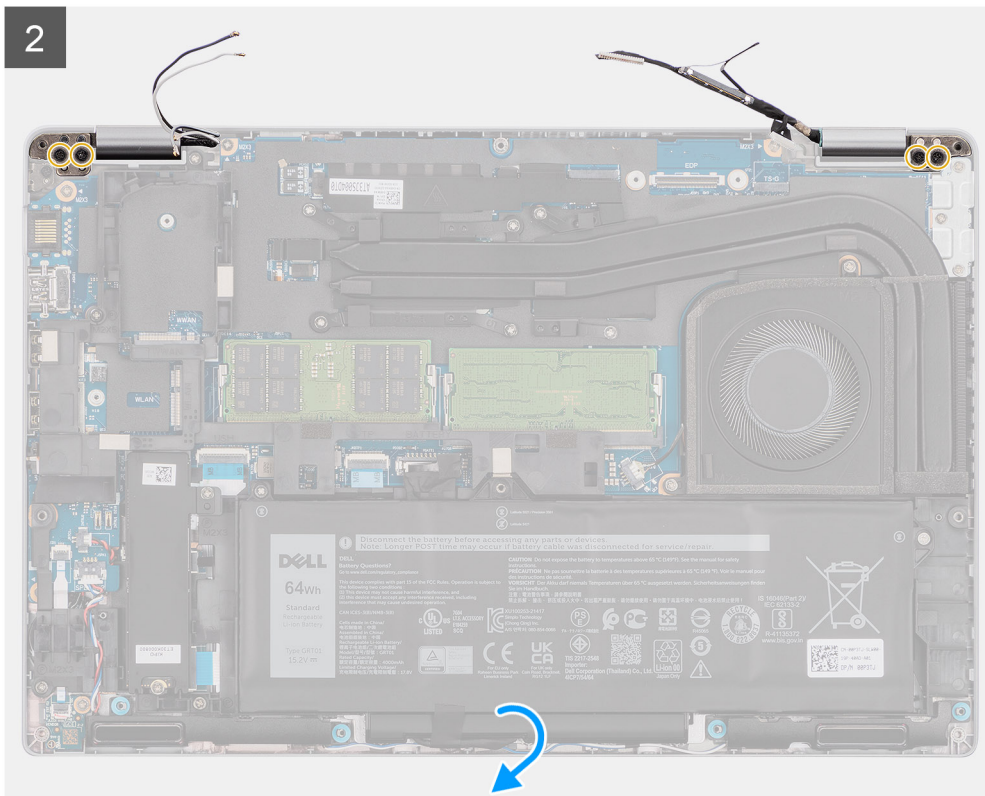

Steps

1. Place the display assembly on the system. Align the screw holes on the display hinges with screw holes on the palm-rest assembly.
2. Replace the four (M2.5x5) screws that secure the display hinges to the palm-rest assembly.
3. Close the display.
4. Route the WLAN antenna cables through the routing guide and adhere the tape to secure the cables to the system board.
5. Route the display and eDP cable through the routing guide on the system board.
6. Connect the eDP cable to the connector on the system board.
7. Connect the display cable to the connector on the system board.
8. Adhere the tape that secures the display cable to the system board.
9. Connect the IR camera cable from its connector on the system board (for models shipped with an IR camera).
10. Connect the touch screen cable from its connector on the system board (for models shipped with a touch screen).
11. Align the screw holes on the eDP cable bracket with the screw holes on the system board.
12. Replace the two screws (M2x3) that secure the eDP cable bracket to the system board.

Next steps

1. Install the [wireless card](#).
2. Install the [base cover](#).
3. Install the [microSD card](#).
4. Follow the procedure in [After working inside your computer](#).

Display bezel

Removing the display bezel

Prerequisites

1. Follow the procedure in [Before working inside your computer](#).
2. Remove the [microSD card](#).
3. Remove the [base cover](#).
4. Remove the [wireless card](#).
5. Remove the [display assembly](#).

About this task

The following images indicate the location of the display bezel and provide a visual representation of the removal procedure.

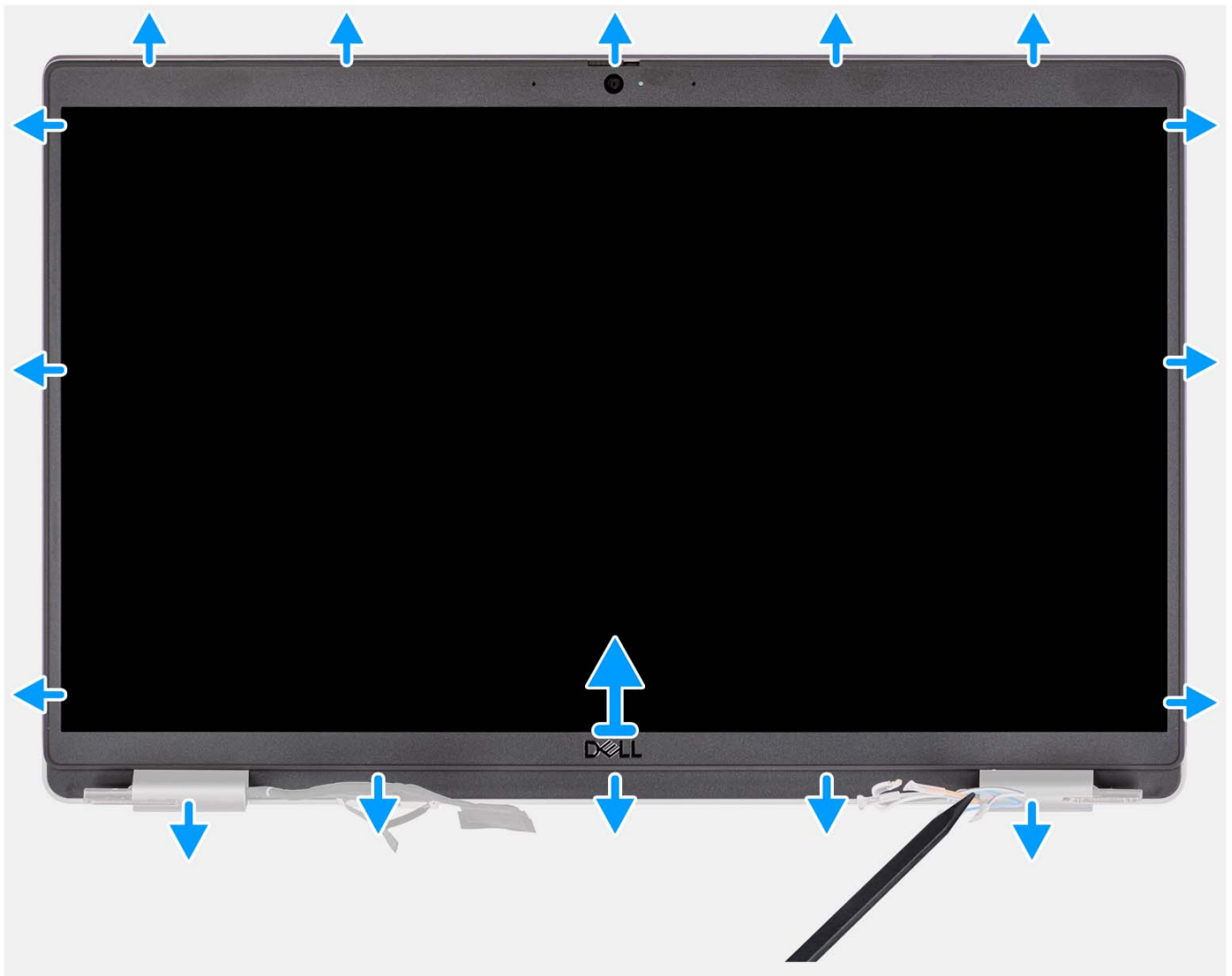

Steps

i NOTE: The display bezel is adhered to the display panel with adhesive. Insert a plastic scribe into the recesses near both hinge caps to start the prying process to release the display bezel. Pry along the outside edge of the display bezel and work your way around the entire display bezel until the display bezel is separated from the display cover.

⚠ CAUTION: Carefully pry and remove the display bezel to minimize the risk of display panel damages.

1. Insert a plastic scribe into the recesses near both hinge caps to start the prying process to release the display bezel.
2. Pry along the outside edge of the display bezel and work your way around the entire display bezel until the display bezel is separated from the display cover.
3. Lift the display bezel from the display assembly.

Installing the display bezel

Prerequisites

If you are replacing a component, remove the existing component before performing the installation procedure.

About this task

The following image indicates the location of the display bezel and provides a visual representation of the installation procedure.

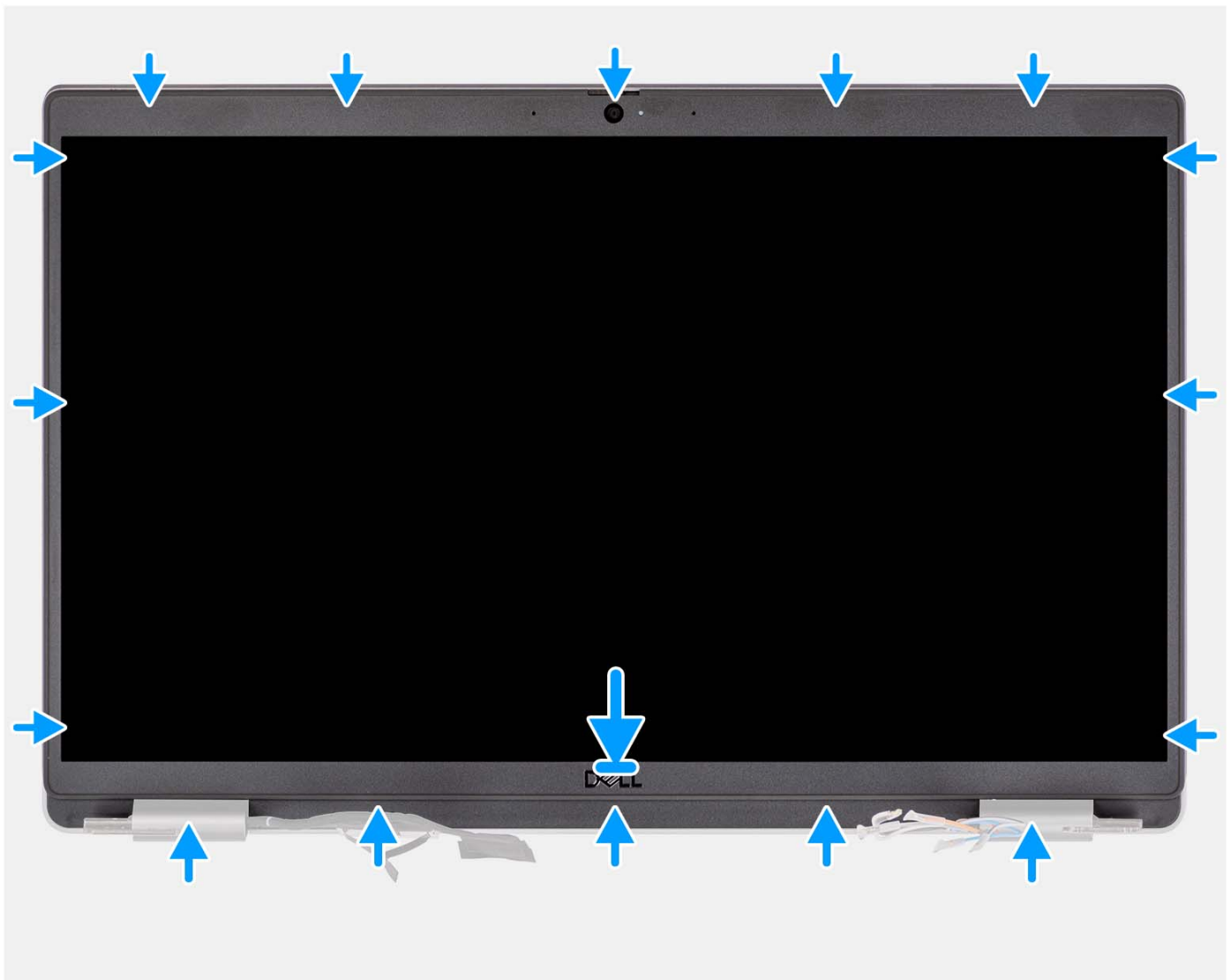

Steps

1. Align and place the display bezel on the display assembly.
2. Gently snap the display bezel into place.

Next steps

1. Install the [display assembly](#).
2. Install the [wireless card](#).
3. Install the [base cover](#).
4. Install the [microSD card](#).
5. Follow the procedure in [After working inside your computer](#).

Display panel

Removing the display panel

Prerequisites

1. Follow the procedure in [Before working inside your computer](#).
2. Remove the [microSD card](#).
3. Remove the [base cover](#).
4. Remove the [wireless card](#).
5. Remove the [display assembly](#).
6. Remove the [display bezel](#).

About this task

The following images indicate the location of the display panel and provide a visual representation of the removal procedure.



2x
M2.5x3

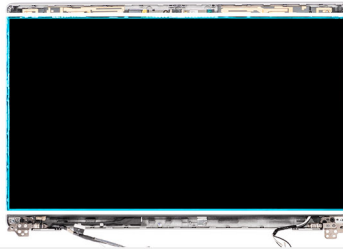

1

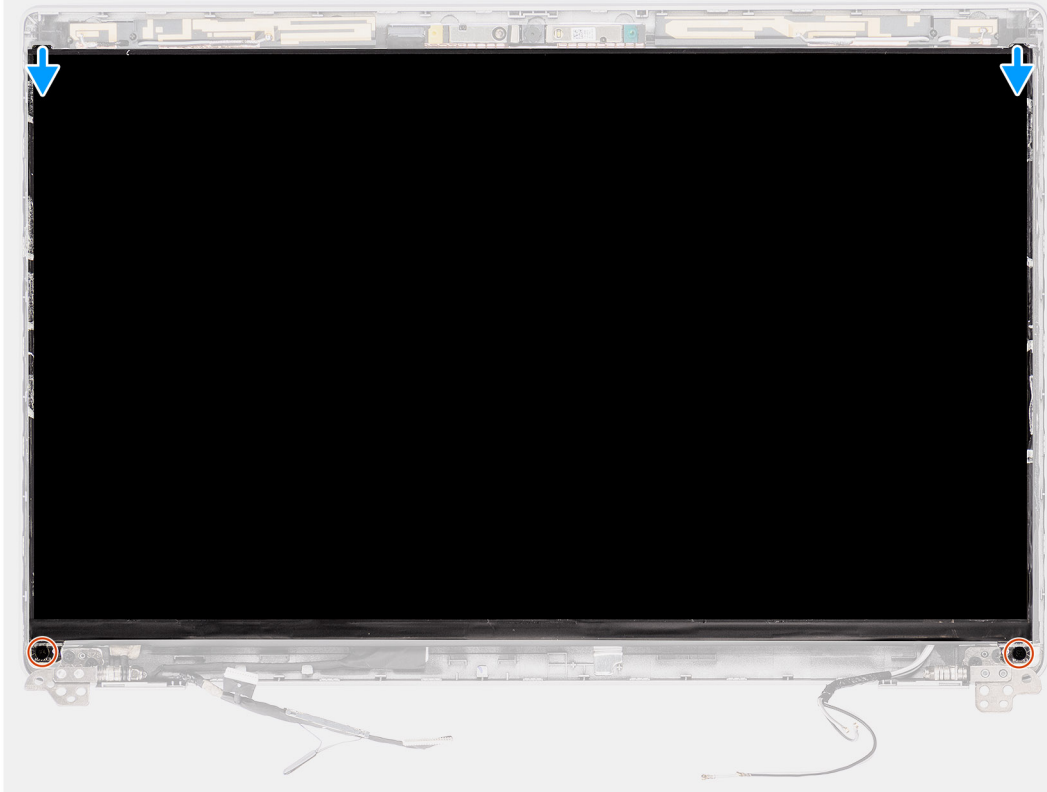

2



3

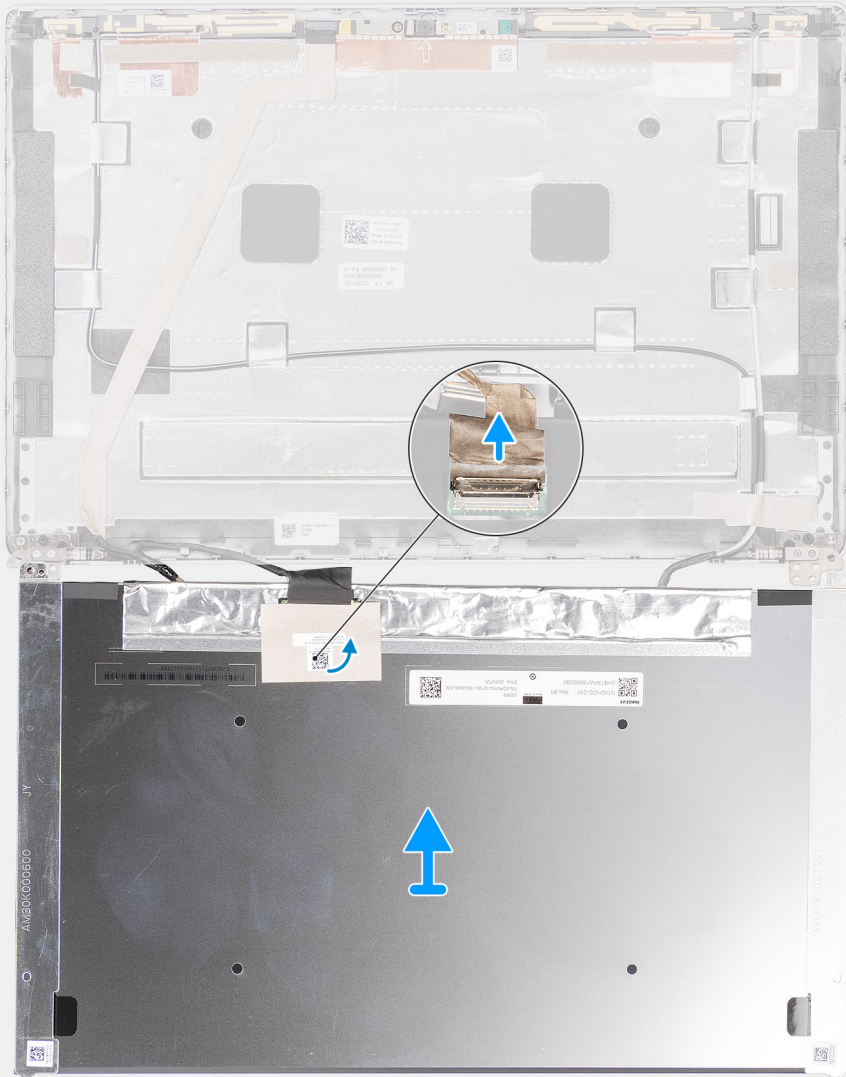



Steps

i **NOTE:** The display panel is preassembled with the display brackets as a single service part. Do not pull the Stretch Release (SR) tapes and separate the brackets from the display panel.

1. Remove the two screws (M2.5x3) that secure the display panel to the display back cover.

i **NOTE:** While removing the display panel, disengage the display panel tabs from the display cover before flipping it over.

2. Lift and open the display panel to access the display cable.

3. Peel the conductive tape on the display cable connector.

4. Peel the clear tape covering the display cable connector.

5. Open the latch and disconnect the cable from the connector on the display panel.

6. Lift the display panel away from the display back cover.

Installing the display panel

Prerequisites

If you are replacing a component, remove the existing component before performing the installation procedure.

About this task

The following images indicate the location of the display panel and provide a visual representation of the installation procedure.

1

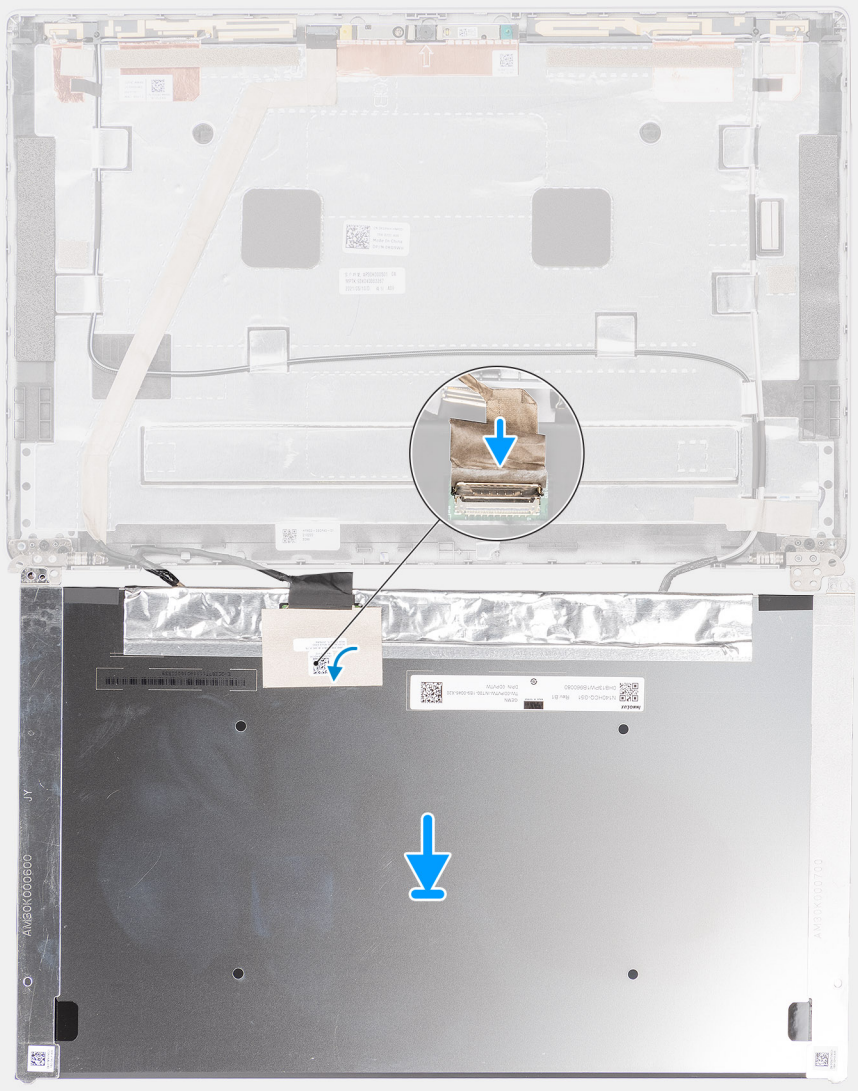



2x
M2.5x3

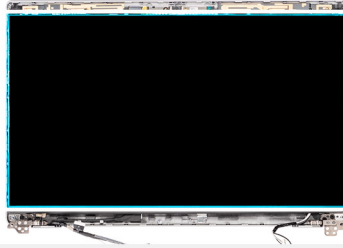

2

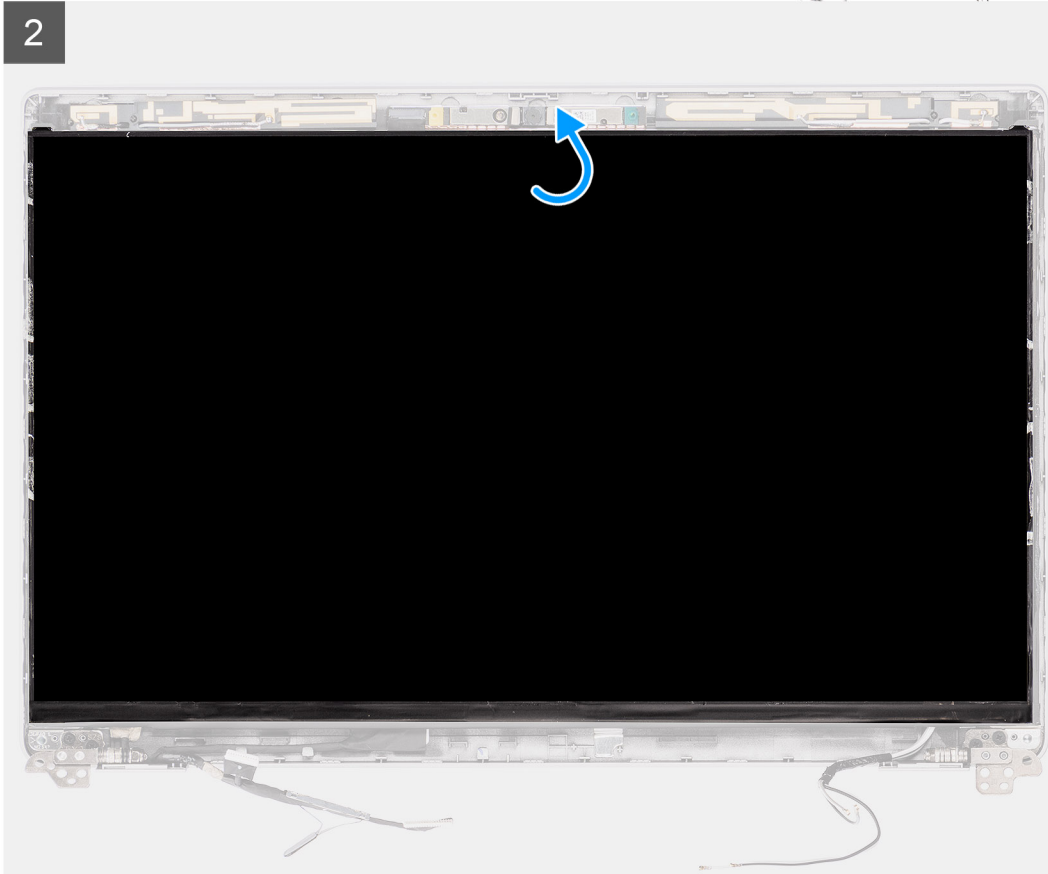

3

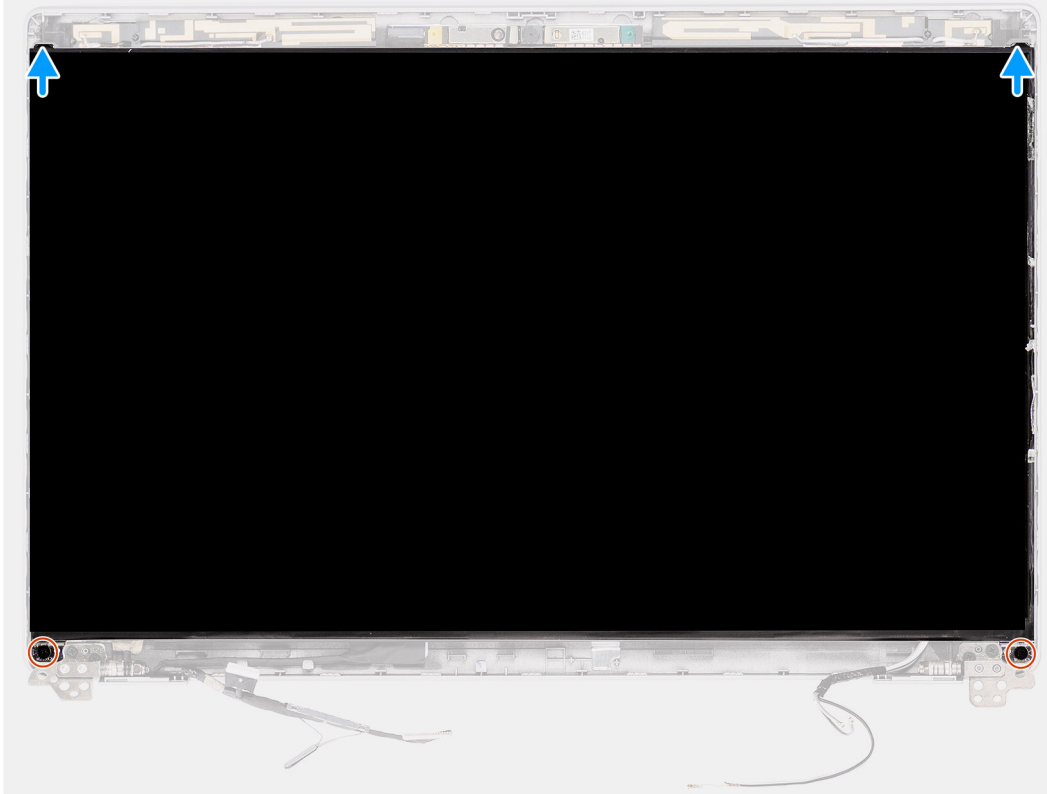

Steps

1. Connect the display cable to the connector on the display panel and close the latch.
2. Adhere the clear tape to cover the display cable connector.
3. Adhere the conductive tape to secure the display cable to the display panel.
4. Close the display panel and the display back cover to assemble.

NOTE: Ensure that the display panel tabs are inserted into the slots on the display cover.

5. Replace the two (M2.5x3) screws to secure the display panel to the display back cover.

Next steps

1. Install the [display bezel](#).
2. Install the [display assembly](#).
3. Install the [wireless card](#).
4. Install the [base cover](#).
5. Install the [microSD card](#).
6. Follow the procedure in [After working inside your computer](#).

Camera

Removing the camera

Prerequisites

1. Follow the procedure in [Before working inside your computer](#).
2. Remove the [microSD card](#).

3. Remove the [base cover](#).
4. Remove the [wireless card](#).
5. Remove the [display assembly](#).
6. Remove the [display bezel](#).
7. Remove the [display panel](#).
8. Remove the [display hinges](#).

About this task

The following images indicate the location of the camera module and provide a visual representation of the removal procedure.

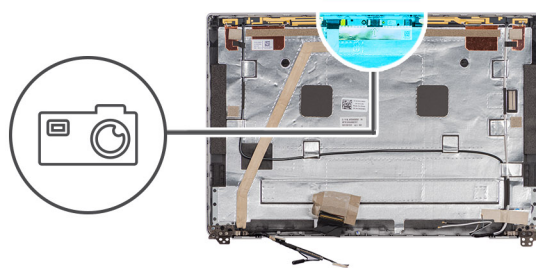

Steps

1. Peel the tape that secures the camera cable.
i **NOTE:** An abrupt peeling may also remove the camera shutter from the display bezel and damage the camera shutter.
2. Lift the latch and disconnect the camera cable from the connector on the camera module.
3. Carefully pry up the camera module starting from the prying point indicated by an etched arrow at the bottom edge of the camera module.

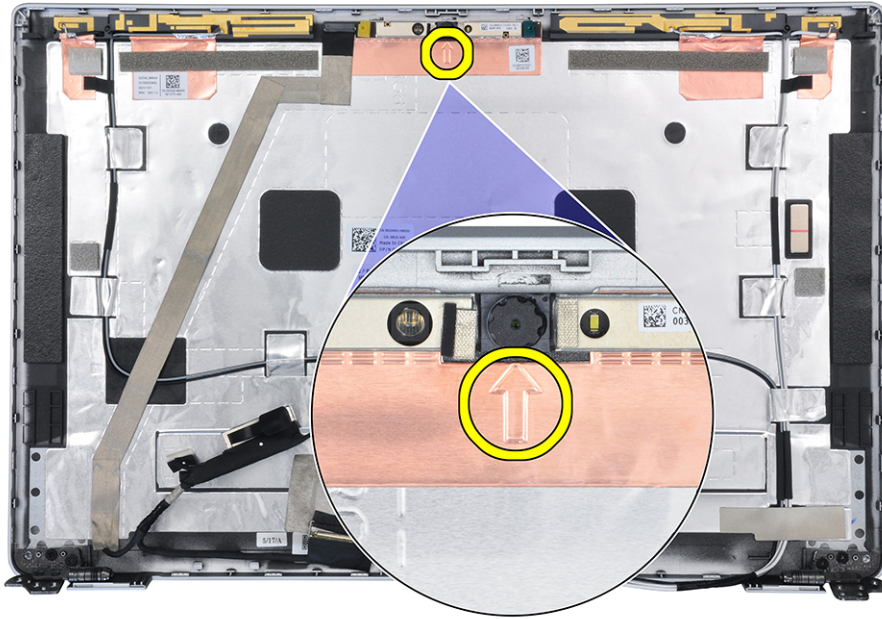

4. Pry up the camera module ensuring that the two tiny pegs used to secure the camera module in place are not damaged throughout the prying process. Carefully lift the camera module from the display back cover.

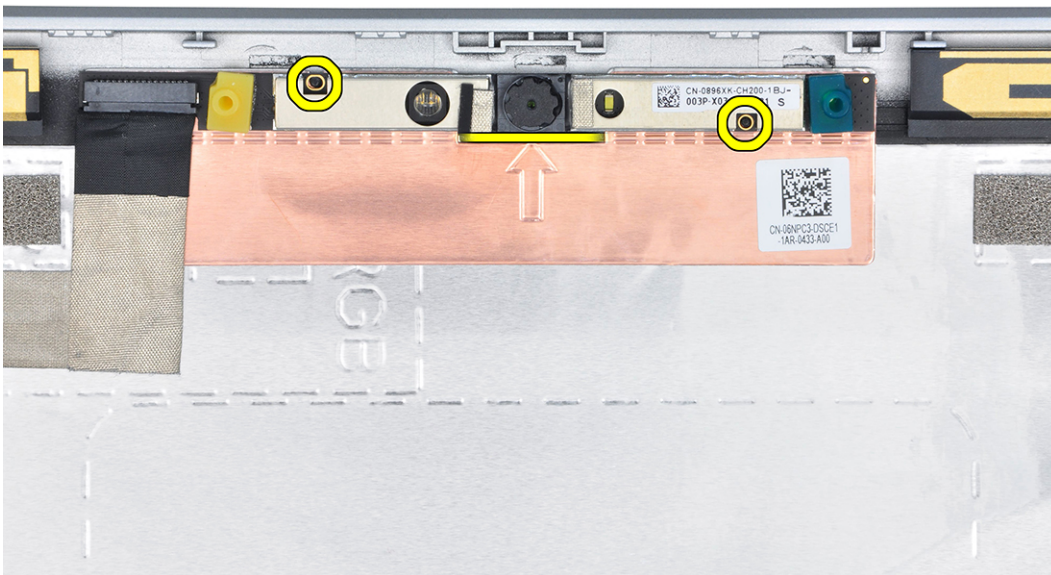

Installing the camera

Prerequisites

If you are replacing a component, remove the existing component before performing the installation procedure.

About this task

The following images indicate the location of the camera and provide a visual representation of the installation procedure.

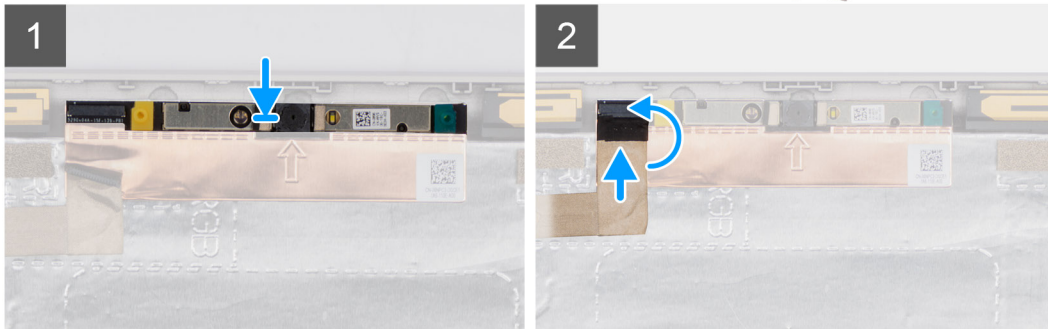
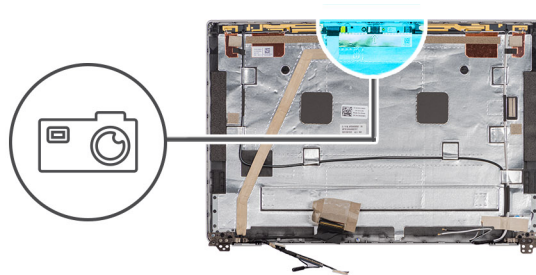

Steps

1. Align and place the camera module into the slot on the display back cover.
2. Connect the camera cable to the connector on the camera module.
3. Adhere the tape to secure the camera cable in place.

Next steps

1. Install the [display hinge](#).
2. Install the [display panel](#).
3. Install the [display bezel](#).
4. Install the [display assembly](#).
5. Install the [wireless card](#).
6. Install the [base cover](#).
7. Install the [microSD card](#).
8. Follow the procedure in [After working inside your computer](#).

Removing the infrared camera

Prerequisites

1. Follow the procedure in [Before working inside your computer](#).
2. Remove the [microSD card](#).
3. Remove the [base cover](#).
4. Remove the [wireless card](#).
5. Remove the [display assembly](#).
6. Remove the [display bezel](#).
7. Remove the [display panel](#).

About this task

The following images indicate the location of the infrared camera module and provide a visual representation of the removal procedure.

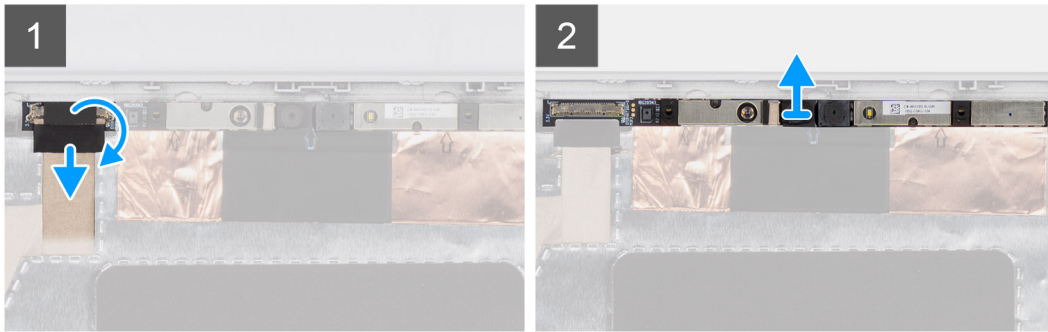
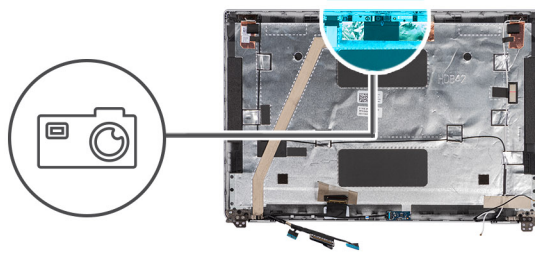

Steps

1. Peel the tape that secures the infrared camera cable.

NOTE: An abrupt peeling may also remove the camera shutter from the display bezel and damage the camera shutter.

2. Lift the latch and disconnect the infrared camera cable from the connector on the camera module.
3. Carefully pry up the camera module starting from the prying point indicated by an etched arrow at the bottom edge of the camera module.

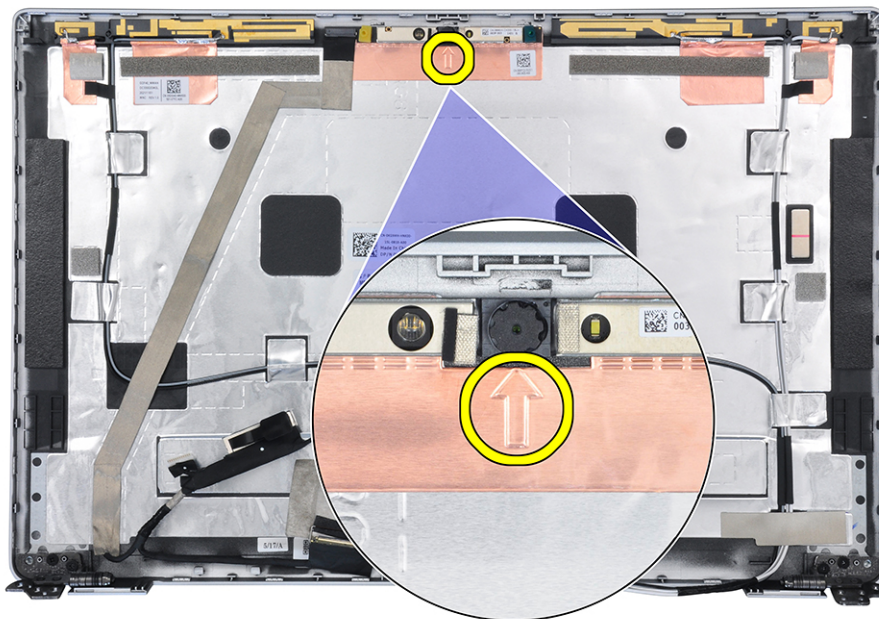

4. Pry up the camera module ensuring that the two tiny pegs used to secure the camera module in place are not damaged throughout the prying process. Carefully lift the camera module from the display back cover.

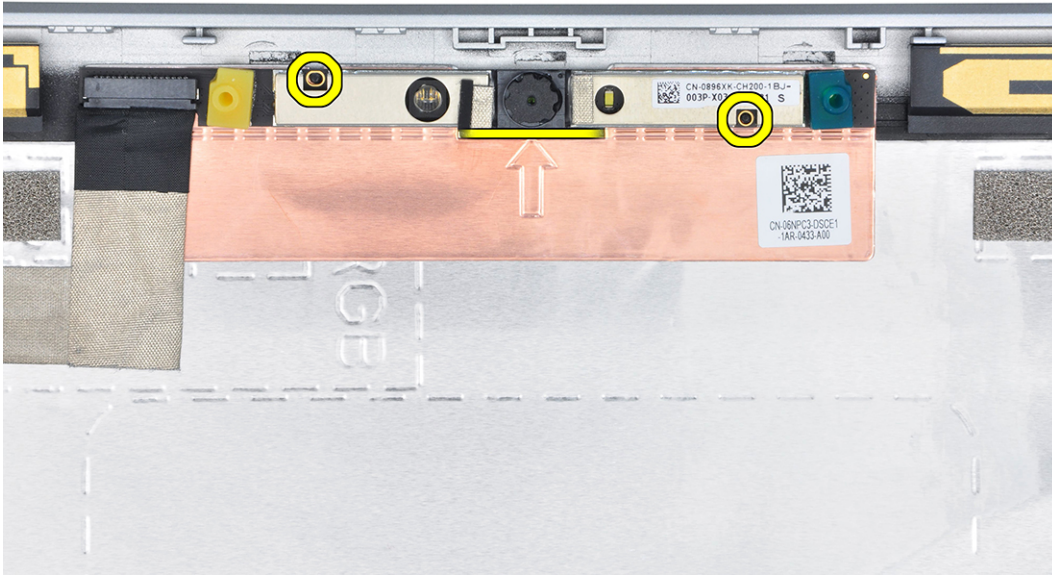

Installing the infrared camera

Prerequisites

If you are replacing a component, remove the existing component before performing the installation procedure.

About this task

The following image indicates the location of the infrared camera and provides a visual representation of the installation procedure.

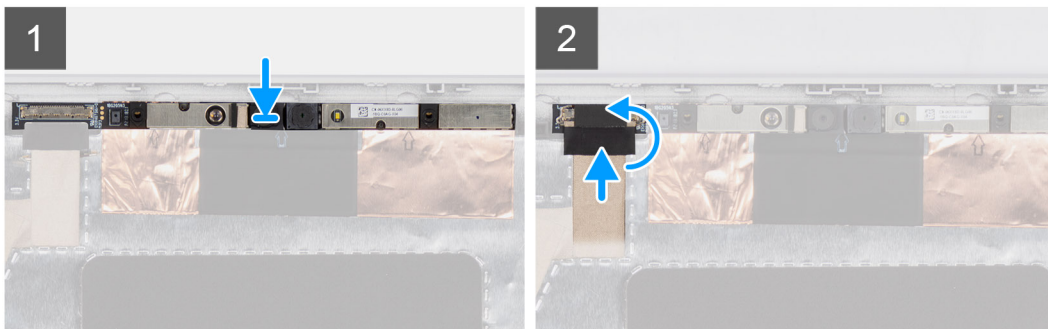
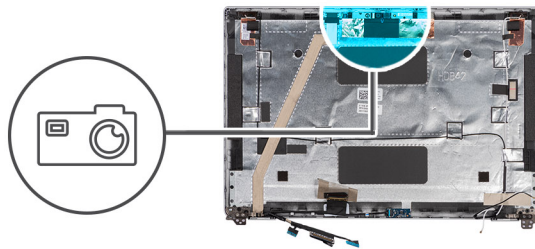

Steps

1. Align and place the infrared camera module into the slot on the display back cover.
2. Connect the infrared camera cable to the connector on the camera module.

3. Adhere the tape to secure the infrared camera cable in place.

Next steps

1. Install the [display panel](#).
2. Install the [display bezel](#).
3. Install the [display assembly](#).
4. Install the [wireless card](#).
5. Install the [base cover](#).
6. Install the [microSD card](#).
7. Follow the procedure in [After working inside your computer](#).

eDP/display cable

Removing the eDP/display cable

Prerequisites

1. Follow the procedure in [Before working inside your computer](#).
2. Remove the [microSD card](#).
3. Remove the [base cover](#).
4. Remove the [wireless card](#).
5. Remove the [display assembly](#).
6. Remove the [display bezel](#).
7. Remove the [display panel](#).

About this task

The following images indicate the location of the eDP cable and provide a visual representation of the removal procedure.

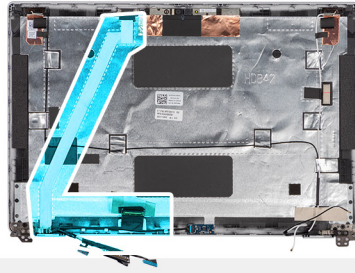

Steps

1. Disconnect the eDP/display cable from the connector on the camera module.
2. Peel the conductive tape and unroute the eDP/display cable to release it from adhesive and lift the eDP/display cable from the display back cover.

Installing the eDP cable

Prerequisites

If you are replacing a component, remove the existing component before performing the installation procedure.

About this task

The following image indicates the location of the eDP cable and provide a visual representation of the installation procedure.

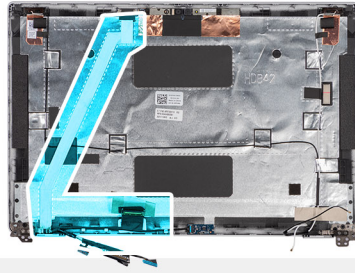

Steps

1. Connect the eDP/display cable to the connector on the camera.
2. Adhere the eDP/display cable to the display back cover.
3. Adhere the conductive tape and route the eDP/display cable to the display back cover.

Next steps

1. Install the [display panel](#).
2. Install the [display bezel](#).
3. Install the [display assembly](#).
4. Install the [wireless card](#).
5. Install the [base cover](#).
6. Install the [microSD card](#).
7. Follow the procedure in [After working inside your computer](#).

Sensor board

Removing the sensor board

Prerequisites

1. Follow the procedure in [Before working inside your computer](#).
2. Remove the [microSD card](#).

3. Remove the [base cover](#).
4. Remove the [wireless card](#).
5. Remove the [display assembly](#).
6. Remove the [display bezel](#).
7. Remove the [display panel](#).

About this task

 **NOTE:** This procedure applies only to computers shipped with a sensor board.

The following image indicates the location of the sensor board and provide a visual representation of the removal procedure.

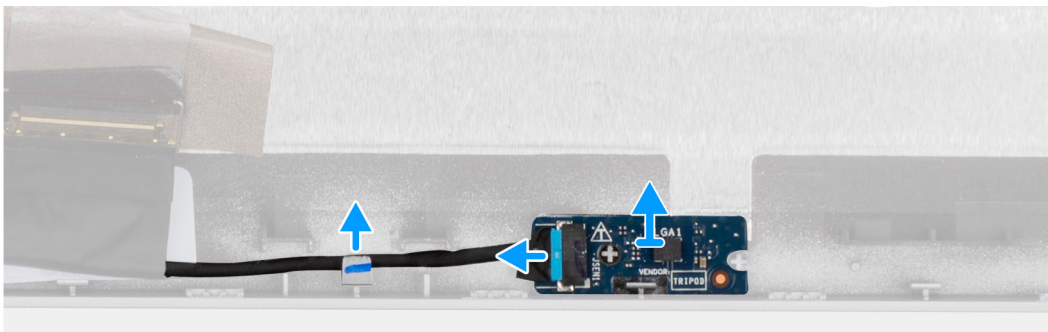
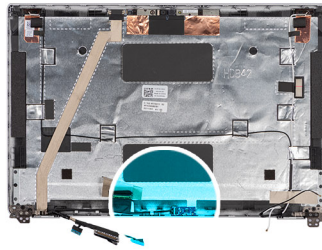

Steps

1. Open the latch and disconnect the LED cable from connector on the sensor board.
2. Gently lift the sensor board away from the display back cover.

Installing the sensor board

About this task

The following image indicates the location of the sensor board and provide a visual representation of the removal procedure.

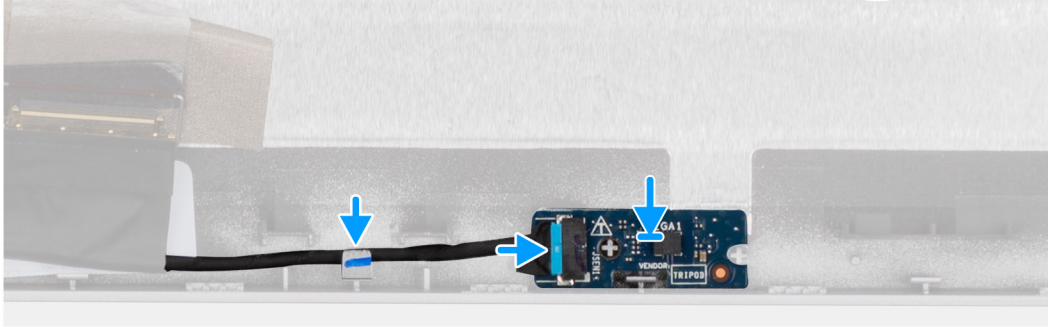

Steps

1. Align and place the sensor board on the display back cover.
2. Connect the LED cable to the connector on the sensor board and close the latch.

Next steps

1. Install the [display panel](#).
2. Install the [display bezel](#).
3. Install the [display assembly](#).
4. Install the [wireless card](#).
5. Install the [base cover](#).
6. Install the [microSD card](#).
7. Follow the procedure in [After working inside your computer](#).

Display hinges

Removing the display hinges

Prerequisites

1. Follow the procedure in [Before working inside your computer](#).
2. Remove the [microSD card](#).
3. Remove the [base cover](#).
4. Remove the [wireless card](#).
5. Remove the [display assembly](#).
6. Remove the [display bezel](#).
7. Remove the [display panel](#).

About this task

The following images indicate the location of the display hinges and provide a visual representation of the removal procedure.



4x
M2.5x3

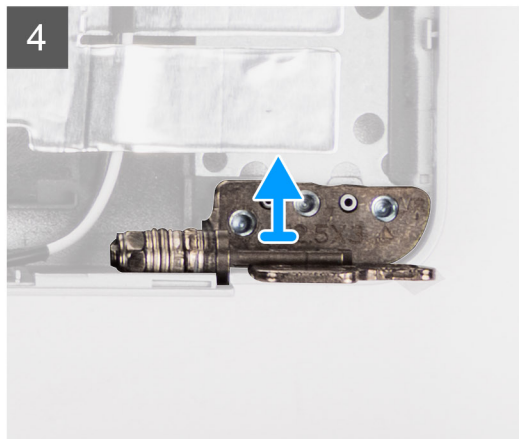
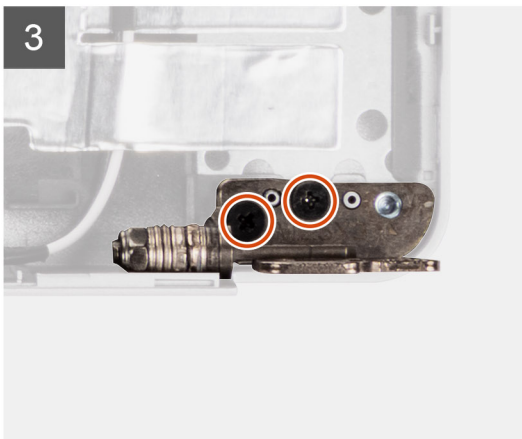
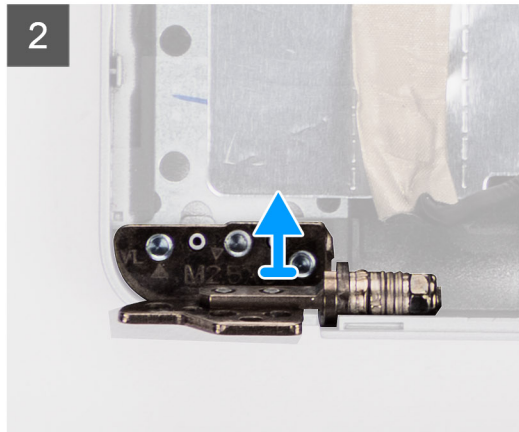
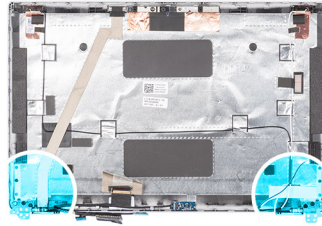

Steps

1. Remove the two (M2.5x3) screws that secure the right hinge to the display back cover.
2. Lift and remove the right hinge from the display back cover.
3. Remove the two (M2.5x3) screws that secure the left hinge to the display back cover.
4. Lift and remove the left hinge from the display back cover.

Installing the display hinges

Prerequisites

If you are replacing a component, remove the existing component before performing the installation procedure.

About this task

The following images indicate the location of the display hinges and provides a visual representation of the installation procedure.



4x
M2.5x3

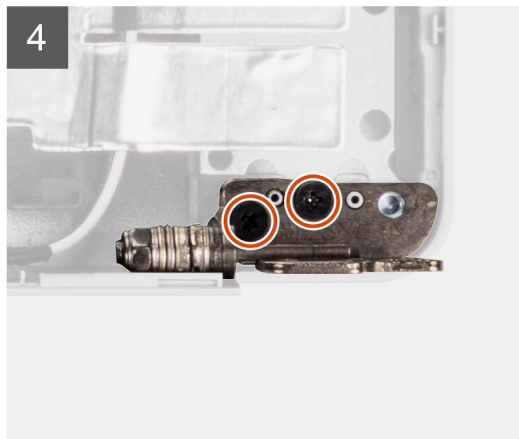
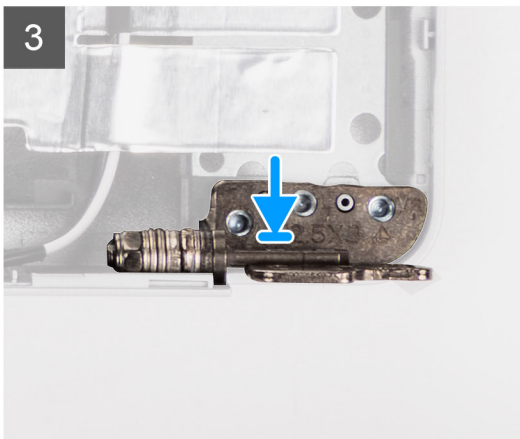
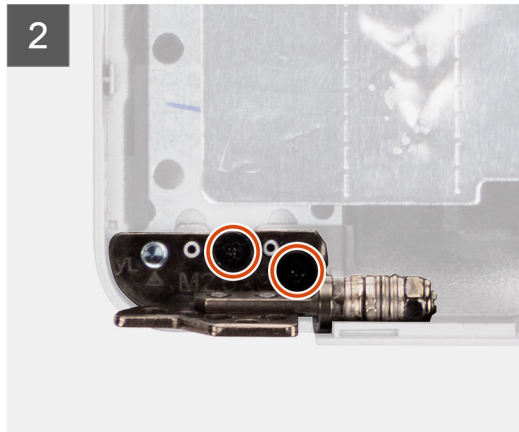
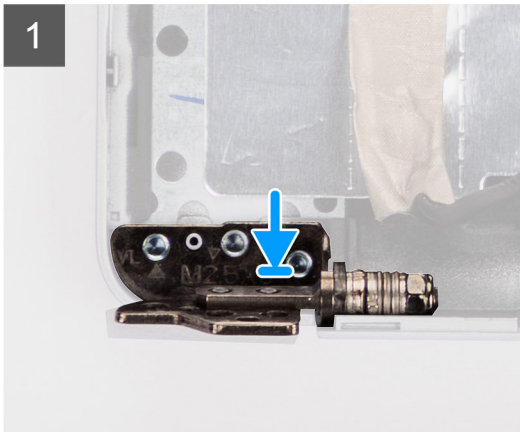
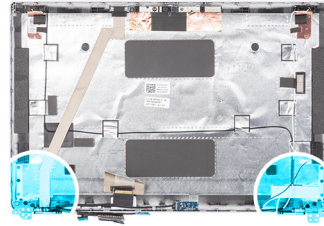

Steps

1. Align the screw hole on the left hinge with the screw hole on the display back cover.
2. Replace the two (M2.5x3) screws to secure the left hinge to the display back cover.
3. Align the screw hole on the right hinge with the screw hole on the display back cover.
4. Replace the two (M2.5x3) screws to secure the right hinge to the display back cover.

Next steps

1. Install the [display panel](#).
2. Install the [display bezel](#).
3. Install the [display assembly](#).
4. Install the [wireless card](#).
5. Install the [base cover](#).
6. Install the [microSD card](#).
7. Follow the procedure in [After working inside your computer](#).

Display back cover

Removing the display back cover

Prerequisites

1. Follow the procedure in [Before working inside your computer](#).
2. Remove the [microSD card](#).
3. Remove the [base cover](#).
4. Remove the [wireless card](#).
5. Remove the [display assembly](#).
6. Remove the [display bezel](#).
7. Remove the [display panel](#).
8. Remove the [camera module](#).
9. Remove the [eDP/display cable](#).
10. Remove the [sensor board](#).
11. Remove the [display hinges](#).

About this task

The following images indicate the location of the display back cover and provide a visual representation of the removal procedure.

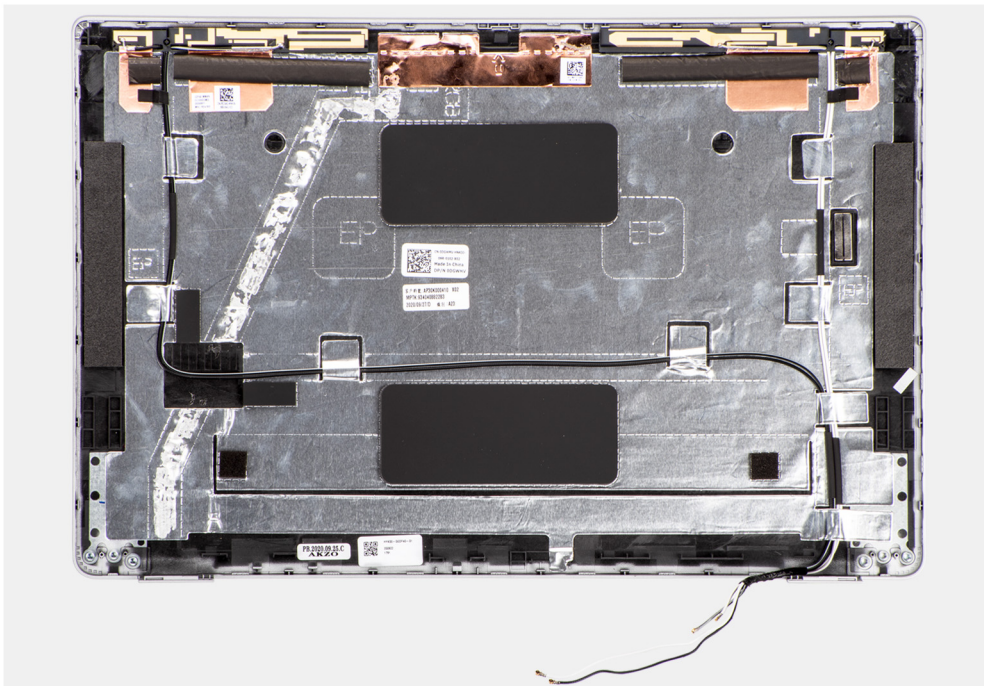

Steps

After performing the steps in the pre-requisites, we are left with the display back cover.

Installing the display back cover

Prerequisites

If you are replacing a component, remove the existing component before performing the installation procedure.

About this task

The following image indicates the location of the display back cover and provides a visual representation of the installation procedure.

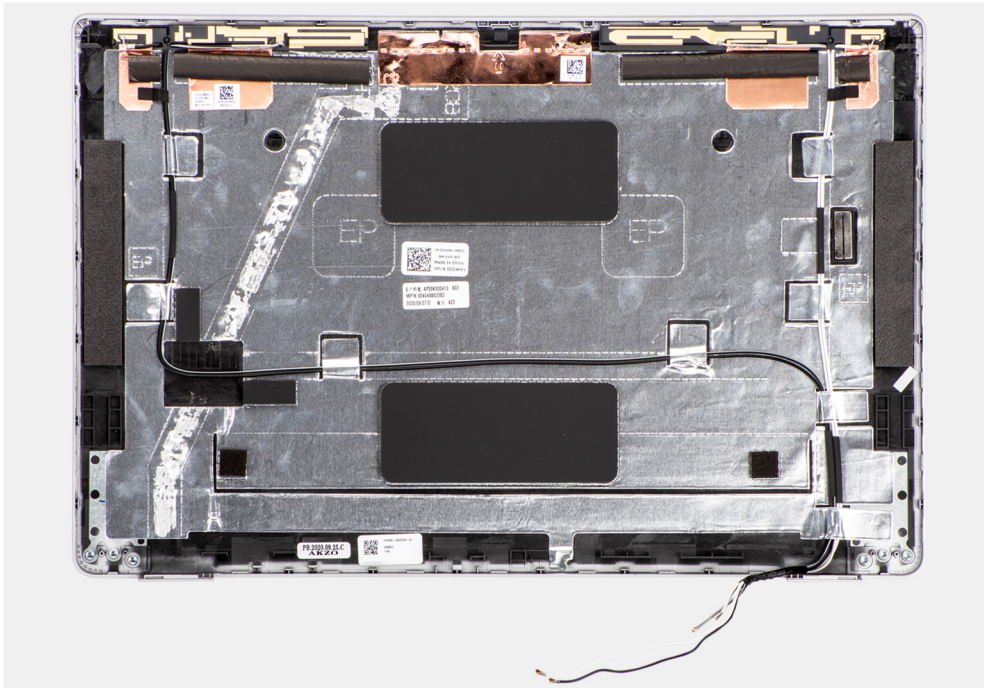

Steps

Place the display back cover on a flat surface.

Next steps

1. Install the [display hinge](#).
2. Install the [sensor board](#).
3. Install the [eDP/display cable](#).
4. Install the [camera module](#).
5. Install the [display panel](#).
6. Install the [display bezel](#).
7. Install the [display assembly](#).
8. Install the [wireless card](#).
9. Install the [base cover](#).
10. Install the [microSD card](#).
11. Follow the procedure in [After working inside your computer](#).

Dummy SIM-card slot filler

Removing the dummy SIM-card slot filler

Prerequisites

1. Follow the procedure in [Before working inside your computer](#).
2. Remove the [microSD card](#).
3. Remove the [base cover](#).
4. Remove the [2280 solid-state drive](#) or [2230 solid-state drive](#).
5. Remove the [memory modules](#).
6. Remove the [battery](#).

7. Remove the [wireless card](#).
8. Remove the heat sink [heat sink](#).
9. Remove the [assembly inner frame](#).
10. Remove the [system board](#).

i **NOTE:** The system board can be removed with the heat sink attached in order to simplify the procedure and preserve the thermal bond between the system board and heat sink.

11. Remove the [power-button board](#).
12. Remove the [LED board](#).
13. Remove the [smart card reader](#).
14. Remove the [Keyboard assembly](#).
15. Remove the [display assembly](#).
16. Remove the [palm-rest assembly](#).

About this task

i **NOTE:** For models shipped with WLAN antennas only, the dummy SIM-card slot filler is a separate service part and is not included with replacement palm rest. As a result, the dummy SIM-card slot filler must be removed and then reinstalled when replacing the palm-rest assembly.

The following images indicate the dummy SIM-card slot filler and provides a visual representation of the dummy SIM-card slot filler removal procedure.

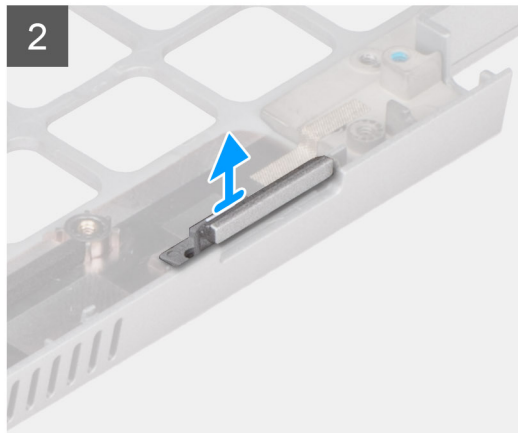
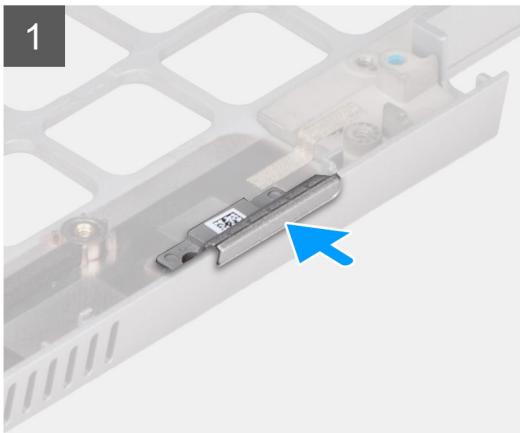
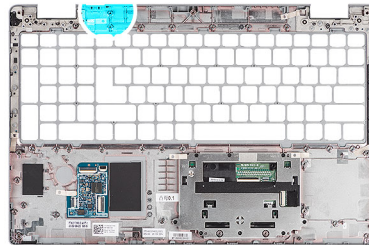

Steps

1. Push the dummy SIM-card slot filler from the top side of the palm-rest assembly.

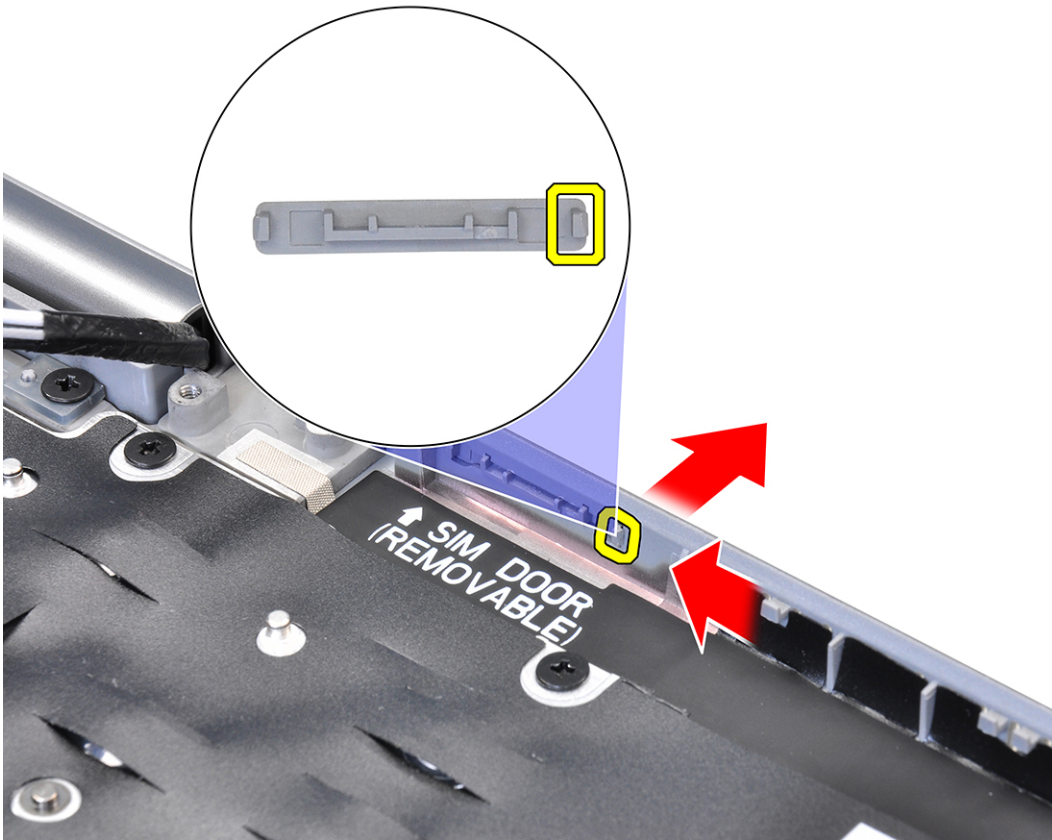

2. Lift the dummy SIM-card slot filler out of the palm-rest assembly.

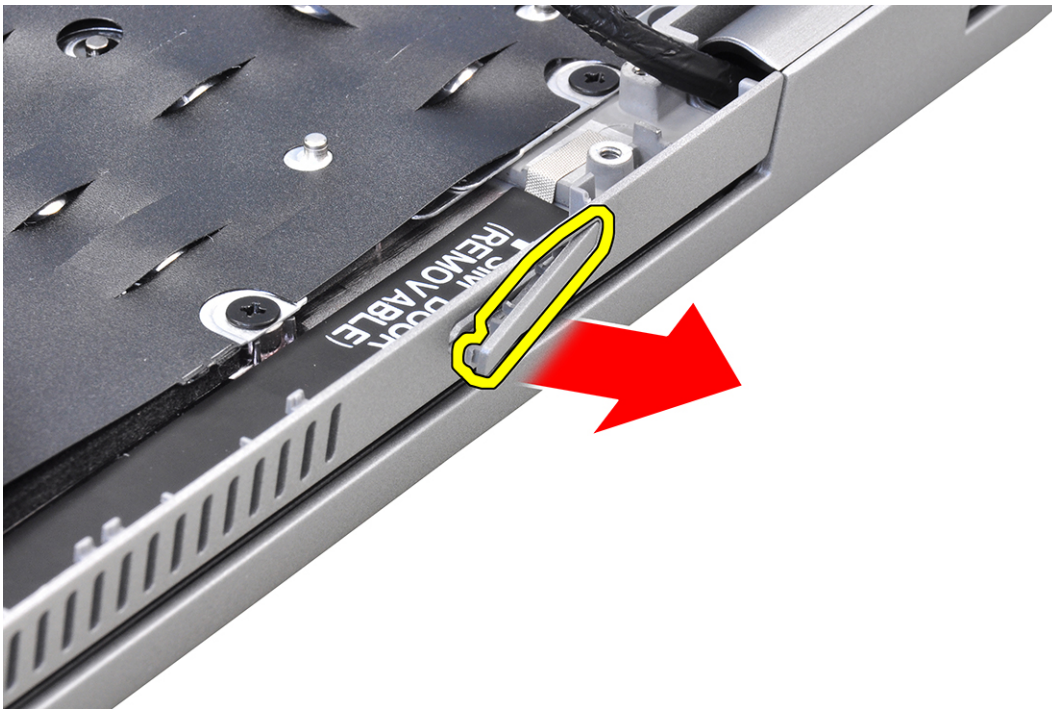

Installing the dummy SIM-card slot filler

Prerequisites

If you are replacing a component, remove the necessary component before the installation procedure.

About this task

The following images indicate the location of the dummy SIM-card slot filler and provides a visual representation of the dummy SIM-card slot filler installation procedure.

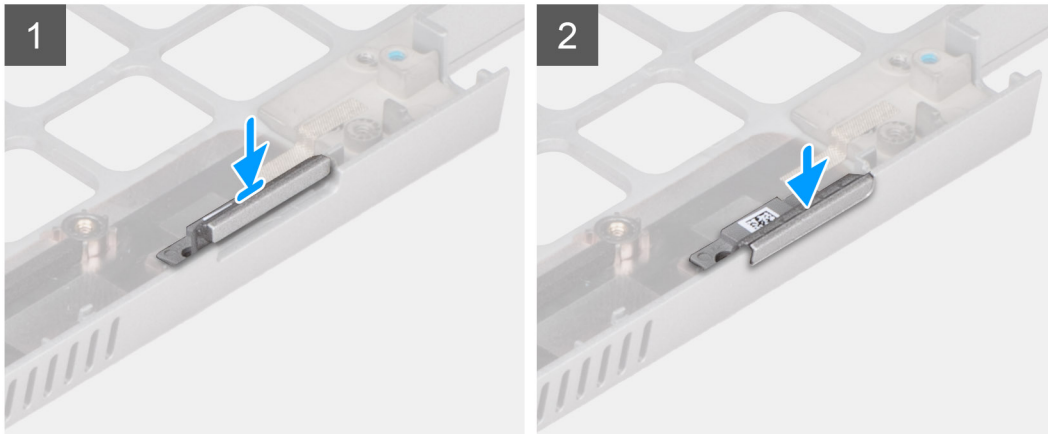
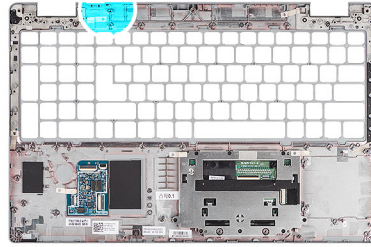

Steps

1. Place the dummy SIM-card slot filler into its compartment on the palm rest.

 **NOTE:** Ensure that the dummy SIM-card slot filler is aligned with the ribs on the palm-rest assembly.

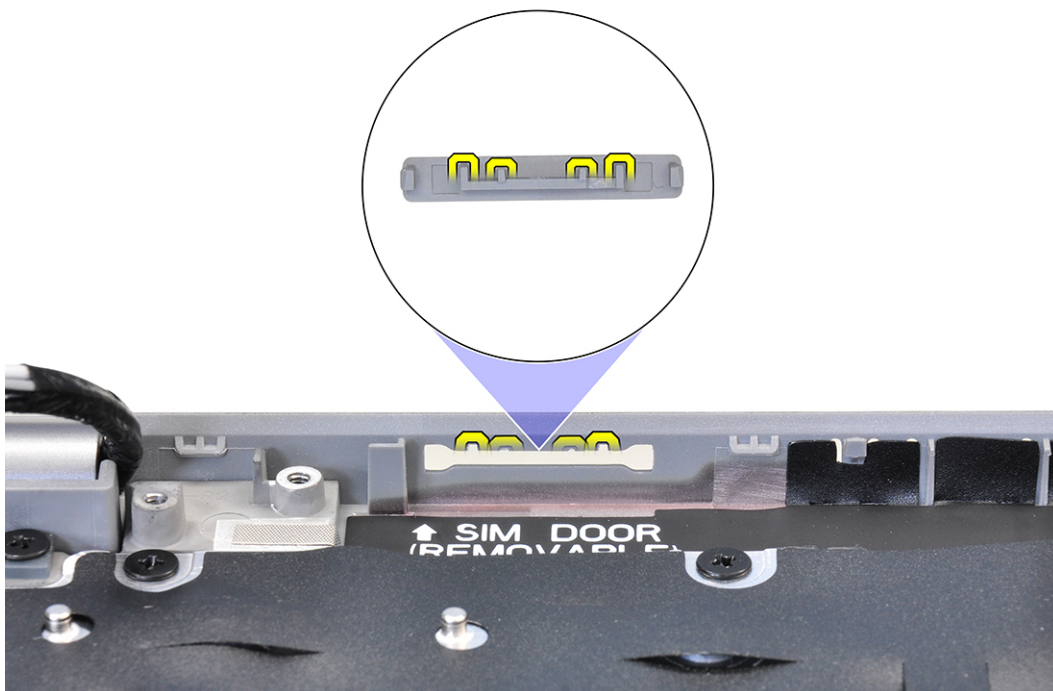

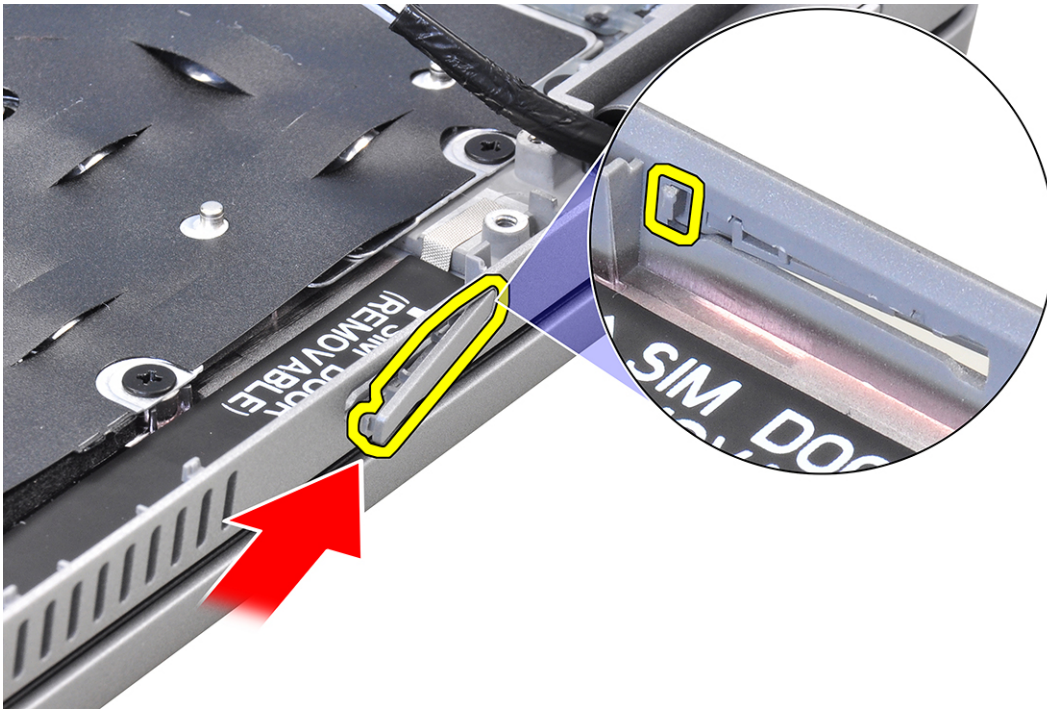

2. Press the dummy SIM-card slot filler until it clicks into place and ensure it fits securely into the SIM card slot.

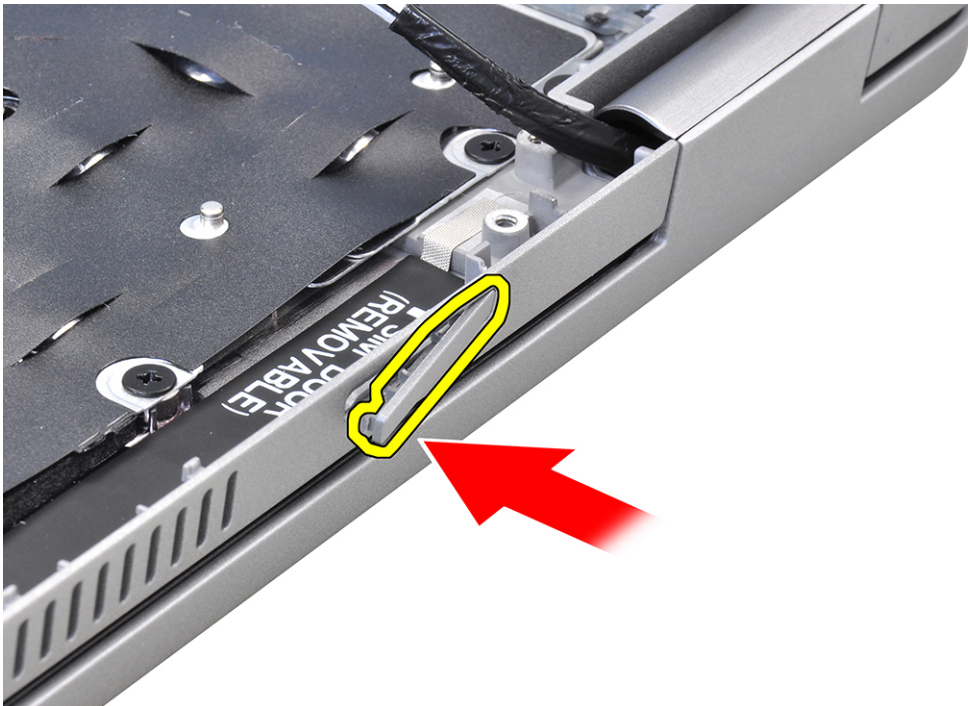

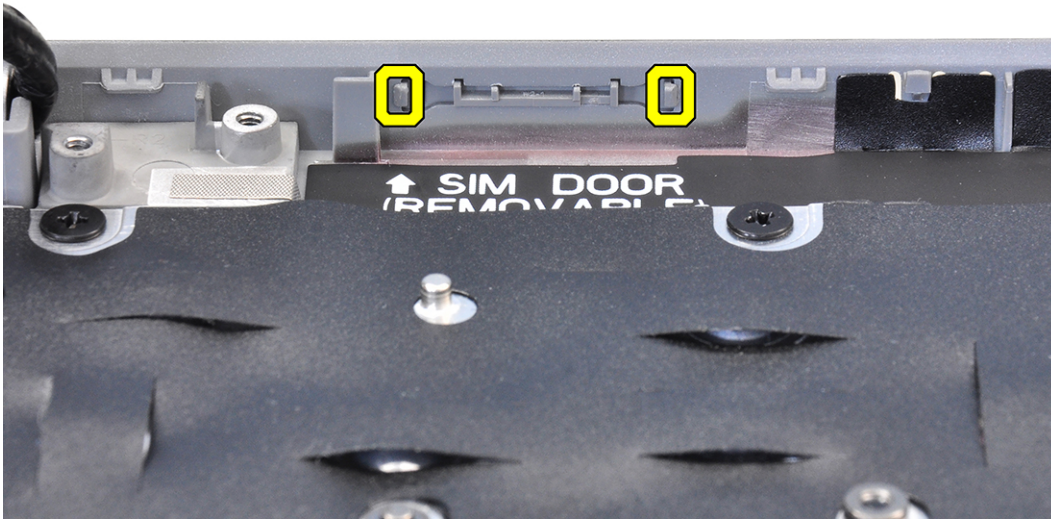

Next steps

1. Install the [palm-rest assembly](#)
2. Install the [display assembly](#).
3. Install the [keyboard assembly](#).
4. Install the [smart card reader](#).
5. Install the [LED board](#).
6. Install the [power-button board](#).
7. Install the [system board](#).
8. Install the [heat sink](#).
9. Install the [assembly inner frame](#).
10. Install the [battery](#).
11. Install the [memory modules](#).
12. Install the [wireless card](#).
13. Install the [2280 solid-state drive](#) or [2230 solid-state drive](#).
14. Install the [base cover](#).
15. Install the [microSD card](#).
16. Follow the procedure in [After working inside your computer](#).

Palm-rest assembly

Removing the palm-rest assembly

Prerequisites

1. Follow the procedure in [Before working inside your computer](#).
2. Remove the [microSD card](#).
3. Remove the [base cover](#).
4. Remove the [2280 solid-state drive](#) or [2230 solid-state drive](#).
5. Remove the [memory modules](#).
6. Remove the [battery](#).
7. Remove the [wireless card](#).

8. Remove the heat sink [heat sink](#).
9. Remove the [assembly inner frame](#).
10. Remove the [system board](#).

i NOTE: The system board can be removed with the heat sink attached in order to simplify the procedure and preserve the thermal bond between the system board and heat sink.

11. Remove the [power-button board](#).
12. Remove the [LED board](#).
13. Remove the [smart card reader](#).
14. Remove the [Keyboard assembly](#).
15. Remove the [display assembly](#).
16. Remove the [dummy SIM-card slot filler](#).

About this task

The following image indicates the palm-rest assembly and provides a visual representation of the removal procedure.

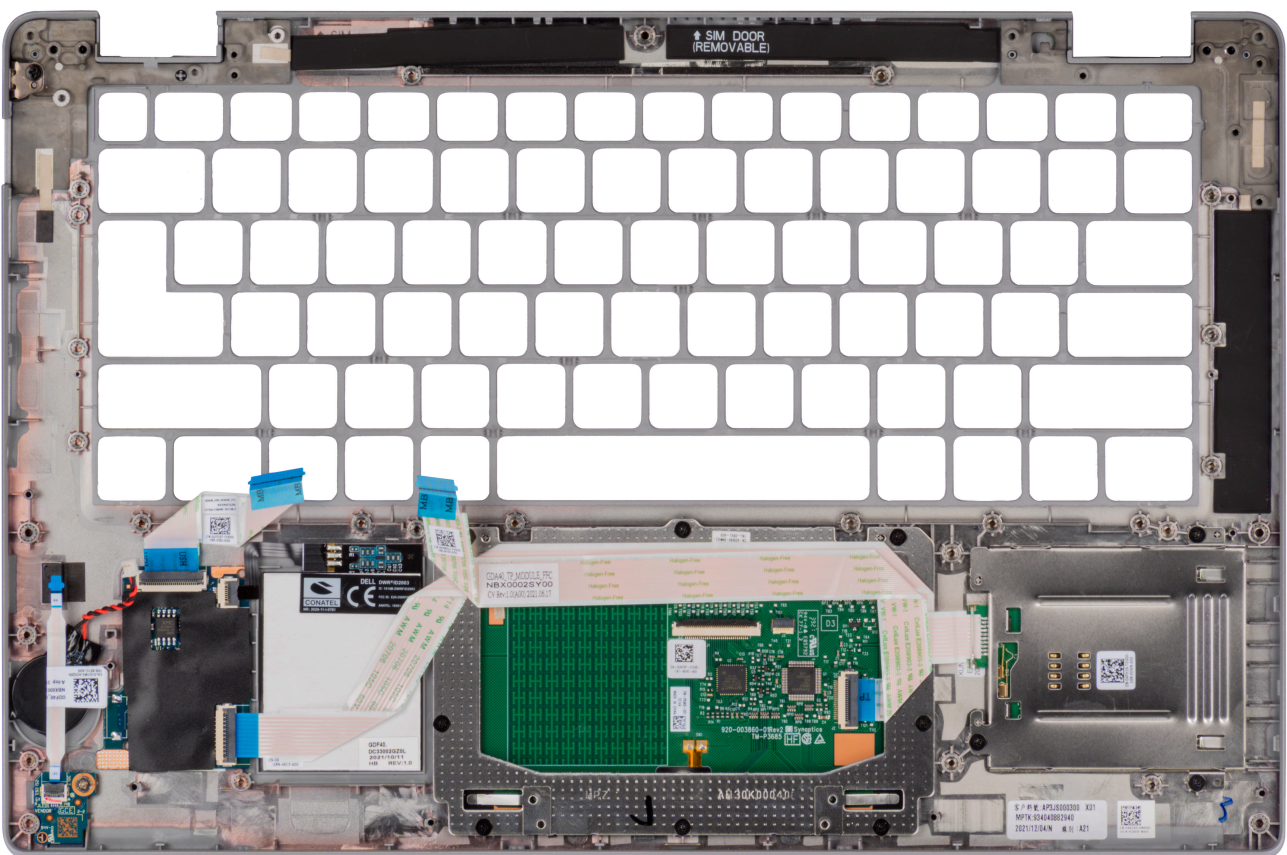

Steps

After performing the steps in the pre-requisites, we are left with the palm-rest assembly.

Installing the palm-rest assembly

Prerequisites

If you are replacing a component, remove the existing component before performing the installation procedure.

About this task

The following image indicates the palm-rest assembly and provides a visual representation of the installation procedure.

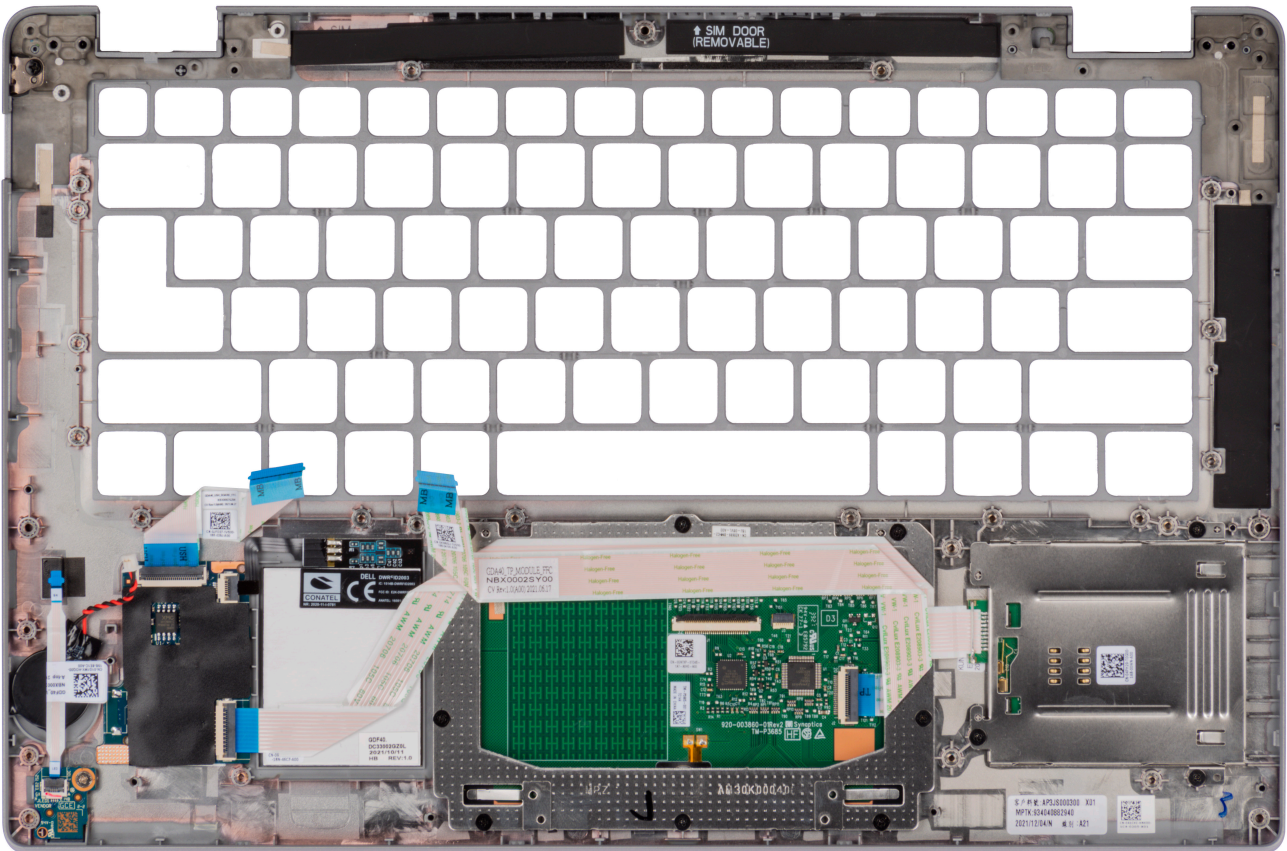

Steps

Place the palm-rest assembly on a flat surface.

NOTE: For models shipped with WLAN antennas only, the filler must be removed then re-installed when replacing the palm-rest assembly.

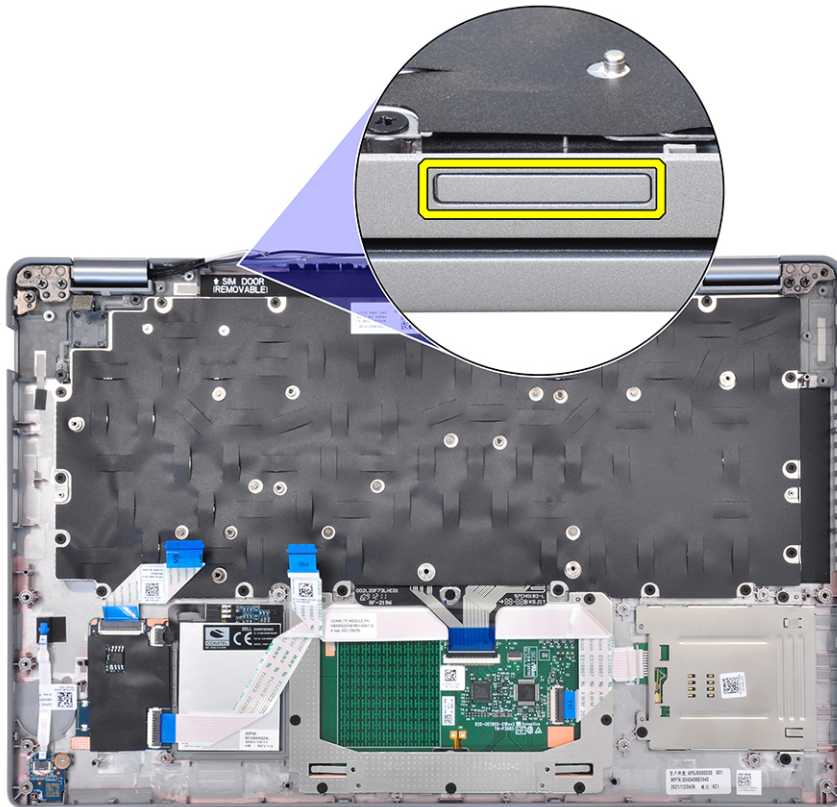

Next steps

1. Install the [dummy SIM-card slot filler](#).
2. Install the [display assembly](#).
3. Install the [keyboard assembly](#).
4. Install the [smart card reader](#).
5. Install the [LED board](#).
6. Install the [power-button board](#).
7. Install the [system board](#).
8. Install the [heat sink](#).
9. Install the [assembly inner frame](#).
10. Install the [battery](#).
11. Install the [memory modules](#).
12. Install the [wireless card](#).
13. Install the [2280 solid-state drive](#) or [2230 solid-state drive](#).
14. Install the [base cover](#).
15. Install the [microSD card](#).
16. Follow the procedure in [After working inside your computer](#).

Drivers and downloads

When troubleshooting, downloading or installing drivers it is recommended that you read the Dell Knowledge Based article, Drivers and Downloads FAQ [000123347](#).

BIOS setup

CAUTION: Unless you are an expert computer user, do not change the settings in the BIOS Setup program. Certain changes can make your computer work incorrectly.

NOTE: Depending on the computer and its installed devices, the items listed in this section may or may not be displayed.

NOTE: Before you change BIOS Setup program, it is recommended that you write down the BIOS Setup program screen information for future reference.

Use the BIOS Setup program for the following purposes:

- Get information about the hardware installed in your computer, such as the amount of RAM and the size of the hard drive.
- Change the system configuration information.
- Set or change a user-selectable option, such as the user password, type of hard drive installed, and enabling or disabling base devices.

Entering BIOS setup program

About this task

Turn on (or restart) your computer and press F2 immediately.

Navigation keys

NOTE: For most of the System Setup options, changes that you make are recorded but do not take effect until you restart the system.

Table 3. Navigation keys

Keys	Navigation
Up arrow	Moves to the previous field.
Down arrow	Moves to the next field.
Enter	Selects a value in the selected field (if applicable) or follow the link in the field.
Spacebar	Expands or collapses a drop-down list, if applicable.
Tab	Moves to the next focus area. NOTE: For the standard graphics browser only.
Esc	Moves to the previous page until you view the main screen. Pressing Esc in the main screen displays a message that prompts you to save any unsaved changes and restarts the system.

One time boot menu

To enter **one time boot menu**, turn on your computer, and then press F12 immediately.

NOTE: It is recommended to shutdown the computer if it is on.

The one-time boot menu displays the devices that you can boot from including the diagnostic option. The boot menu options are:

- Removable Drive (if available)
- M.2 Drive (if available)
- **i** **NOTE:** XXX denotes the M.2 drive number.
- Optical Drive (if available)
- NVMe Drives
- Diagnostics

The boot sequence screen also displays the option to access the System Setup screen.

System setup options

i **NOTE:** Depending on your computer and its installed devices, the items listed in this section may or may not appear.

Table 4. System setup options—System information menu

Overview	
Latitude 5431	
BIOS Version	Displays the BIOS version number.
Service Tag	Displays the Service Tag of the computer.
Asset Tag	Displays the Asset Tag of the computer.
Manufacture Date	Displays the manufacture date of the computer.
Ownership Date	Displays the ownership date of the computer.
Express Service Code	Displays the express service code of the computer.
Ownership Tag	Displays the Ownership Tag of the computer.
Signed Firmware Update	Displays whether the Signed Firmware Update is enabled on your computer.
Battery Information	
Primary	Displays that battery is primary.
Battery Level	Displays the battery level of the computer.
Battery State	Displays the battery state of the computer.
Health	Displays the battery health of the computer.
AC Adapter	Displays whether the AC adapter is connected or not.
Battery Life Type	Display the Battery Life type of the computer
Processor Information	
Processor Type	Displays the processor type.
Maximum Clock Speed	Displays the maximum processor clock speed.
Minimum Clock Speed	Displays the minimum processor clock speed.
Current Clock Speed	Displays the current processor clock speed.
Core Count	Displays the number of cores on the processor.
Processor ID	Displays the processor identification code.
Processor L2 Cache	Displays the processor L2 Cache size.
Processor L3 Cache	Displays the processor L3 Cache size.
Microcode Version	Displays the microcode version.
Intel Hyper-Threading Capable	Displays whether the processor is Hyper-Threading (HT) capable.

Table 4. System setup options—System information menu (continued)

Overview	
64-Bit Technology	Displays whether 64-bit technology is used.
Memory Information	
Memory Installed	Displays the total computer memory installed.
Memory Available	Displays the total computer memory available.
Memory Speed	Displays the memory speed.
Memory Channel Mode	Displays single or dual channel mode.
Memory Technology	Displays the technology used for the memory.
DIMM_SLOT 1	Displays the DIMM 1 memory size.
DIMM_SLOT 2	Displays the DIMM 2 memory size.
Devices Information	
Panel Type	Displays the Panel Type of the computer.
Video Controller	Displays the video controller type of the computer.
Video Memory	Displays the video memory information of the computer.
Wi-Fi Device	Displays the wireless device information of the computer.
Native Resolution	Displays the native resolution of the computer.
Video BIOS Version	Displays the video BIOS version of the computer.
Audio Controller	Displays the audio controller information of the computer.
Bluetooth Device	Displays the Bluetooth device information of the computer.
LOM MAC Address	Displays the LAN On Motherboard (LOM) MAC address of the computer.
Pass Through MAC Address	Displays the pass through MAC address of the computer.
Cellular Device	Displays the M.2 PCIe SSD information of the computer.
dGPU Video Controller	Displays the Discrete graphics card information on the computer.

Table 5. System setup options—Boot Configuration menu

Boot Configuration	
Boot Sequence	
Boot mode	Displays the boot mode.
Boot Sequence	Displays the boot sequence.
Secure Digital (SD) Card Boot	Enable or disable the SD card read-only boot. By default, the Secure Digital (SD) Card Boot option is not enabled.
Secure Boot	
Enable Secure Boot	Enable or disable the secure boot feature. By default, the option is enabled.
Secure Boot Mode	Enable or disable to change the secure boot mode options. By default, the Deployed Mode is enabled.
Expert Key Management	
Enable Custom Mode	Enable or disable custom mode. By default, the custom mode option is not enabled.
Custom Mode Key Management	Select the custom values for expert key management.

Table 6. System setup options—Integrated Devices menu

Integrated Devices	
Date/Time	Displays the current date in MM/DD/YYYY format and current time in HH:MM:SS AM/PM format.
Camera	Enables or disable the camera. By default, the Enable Camera option is selected
Audio Enable Audio	Enable or disable the integrated audio controller. By default, all the options are enabled.
USB/Thunderbolt Configuration	<ul style="list-style-type: none"> • Enable or disable booting from USB mass storage devices connected to external USB ports. By default, the Enable External USB Ports option is enabled. • Enable or disable booting from USB mass storage devices such as external hard drive, optical drive, and USB drive. By default, the Enable USB Boot Support option is enabled.
Enable Thunderbolt Technology Support	Enable or disable the associated ports and adapters. By default, the Enable Thunderbolt Technology Support option is selected.
Enable Thunderbolt Boot Support	Enable or disable the Thunderbolt adapter peripheral device and USB devices connected to the Thunderbolt adapter to be used during BIOS Pre-boot. By default, the Enable Thunderbolt Boot Support option is disabled.
Enable Thunderbolt (and PCIe behind TBT) pre-boot modules	Enable or disable the PCIe devices that are connected through a Thunderbolt adapter to execute the PCIe devices UEFI Option ROM (if present) during pre-boot. By default, the Enable Thunderbolt (and PCIe behind TBT) pre-boot modules option is disabled.
Disable USB4 PCIE Tunneling	Disable the USB4 PCIE Tunneling option. By default, the option is disabled.
Video/Power only on Type-C Ports	Enable or disable the Type-C port functionality to video or only power. By default, the Video/Power only on Type-C Ports option is disabled.
Type-C Dock Override	Enables to use connected Type-C Dell Dock to provide data stream with external USB ports disabled. When Type-C Dock override is enabled, the Video/Audio/Lan submenu is activated. By default, the Type-C Dock Override option is enabled.
Video	Enable or disable the usage of video on Dell Dock external ports. By default, the Video option is disabled.
Audio	Enable or disable the usage of audio on Dell Dock external ports. By default, the Audio option is enabled.
Lan	Enable or disable the usage of LAN on Dell Dock external ports. By default, the Lan option is enabled.
Miscellaneous Devices	Enable or disable Fingerprint Reader device. By default, the Enable Fingerprint Reader Device option is enabled.
Unobtrusive Mode Enable Unobtrusive Mode	Enable or disable all the computer light and sound.

Table 6. System setup options—Integrated Devices menu (continued)

Integrated Devices	
By default, the Enable Unobtrusive Mode option is disabled.	

Table 7. System setup options—Storage menu

Storage	
SMART Reporting	
Enable SMART Reporting	Enable or disable Self-Monitoring, Analysis, and Reporting Technology (SMART) during computer startup. By default, the Enable SMART Reporting option is not enabled.
Drive Information	
M.2 PCIe SSD-1	
Type	Displays the M.2 PCIe SSD-1 type information of the computer.
Device	Displays the M.2 PCIe SSD-1 device information of the computer.
Enable MediaCard	
Secure Digital (SD) Card	Enable or disable the SD card. By default, the Secure Digital (SD) Card option is enabled.
Secure Digital (SD) Card Read-Only Mode	Enable or disable the SD card read-only mode. By default, the Secure Digital (SD) Card Read-Only Mode option is not enabled.

Table 8. System setup options—Display menu

Display	
Display Brightness	
Brightness on battery power	Enable to set screen brightness when the computer is running on battery power.
Brightness on AC power	Enable to set screen brightness when the computer is running on AC power.
Touchscreen	Enable to activate the Touchscreen on operating system
Full Screen Logo	
	Enable or disable full screen logo. By default, the option is not enabled.

Table 9. System setup options—Connection menu

Connection	
Network Controller Configuration	
Integrated NIC	Controls the on-board LAN controller. By default, the Enabled with PXE option is enabled.
Enable UEFI Network Stack	Enable or disable UEFI Network Stack. By default, the Enable UEFI Network Stack and Enabled w/PXE option are enabled.
Wireless Device Enable	
WWAN/GPS	Enable or disable the internal WWAN/GPS device By default, the option enabled.
WWAN Bus Mode	Set the interface type of the Wireless Wan (WWAN) card.

Table 9. System setup options—Connection menu (continued)

Connection	
	By default, the Bus Mode PCIe option is enabled.
WLAN	Enable or disable the internal WLAN device By default, the option enabled.
Bluetooth	Enable or disable the internal Bluetooth device By default, the option enabled.
Contactless smartcard/NFC	Enable or disable the internal Contactless smartcard/NFC device By default, the option enabled.
Enable UEFI Network Stack	Enable or disable UEFI Network Stack and controls the on-board LAN Controller. By default, the Enable UEFI Network Stack option are enabled.
Wireless Radio Control	
Control WLAN radio	Sense the connection of the computer to a wired network and subsequently disable the selected wireless radios (WLAN). By default, the option is disabled.
Control WWAN radio	Sense the connection of the computer to a wired network and subsequently disable the selected wireless radios (WWAN). By default, the option is disabled.
HTTPs Boot Feature	
HTTPs Boot	Enable or disable the HTTPs Boot feature. By default, the HTTPs Boot option is enabled.
HTTPs Boot Mode	With Auto Mode, the HTTPs Boot extracts Boot URL from the DHCP. With Manual Mode, the HTTPs Boot reads Boot URL from the user-provided data. By default, the Auto Mode option is enabled.

Table 10. System setup options—Power menu

Power	
Battery configuration	Enables the computer to run on battery during peak power usage hours. Use the table Custom Charge Start and Custom Charge Stop , to prevent AC power usage between certain times of each day. By default, the Adaptive option is enabled.
Advanced Configuration	
Enable Advanced Battery Charge Configuration	Enable or disable the advanced battery charge configuration. By default, the Enable Advanced Battery Charge Configuration option is disabled.
Peak Shift	Enables the computer to run on battery during peak power usage hours. By default, the Enable Peak Shift option is enabled.
Enable Peak Shift	
USB PowerShare	
Enable USB PowerShare	Enable or disable the USB PowerShare. By default, the Enable USB PowerShare option is disabled

Table 10. System setup options—Power menu (continued)

Power	
Thermal Management	<p>Enables to cool the fan and processor heat management to adjust the computer performance, noise, and temperature.</p> <p>By default, the Optimized option is enabled.</p>
USB Wake Support	
Wake on Dell USB-C Dock	<p>When enabled, connecting a Dell USB-C Dock will wake the computer from standby.</p> <p>By default, the Wake on Dell USB-C Dock option is enabled.</p>
Block Sleep	<p>Enables to block entering sleep (S3) mode in the operating system.</p> <p>By default, the Block Sleep option is disabled.</p>
Lid Switch	<p>Enable or disable the lid switch.</p> <p>By default, the Lid Switch option is enabled.</p>
Intel Speed Shift Technology	<p>Enable or disable the Intel speed shift technology support.</p> <p>By default, the Intel Speed Shift Technology option is enabled.</p>

Table 11. System setup options—Security menu

Security	
TPM 2.0 Security	
TPM 2.0 Security On	<p>Enable or disable TPM 2.0 security options.</p> <p>By default, the TPM 2.0 Security On option is enabled.</p>
Attestation Enable	<p>Enables to control whether the Trusted Platform Module (TPM) Endorsement Hierarchy is available to the operating system.</p> <p>By default, the Attestation Enable option is enabled.</p>
Key Storage Enable	<p>Enables to control whether the Trusted Platform Module (TPM) Storage Hierarchy is available to the operating system.</p> <p>By default, the Key Storage Enable option is enabled.</p>
SHA-256	<p>BIOS and the TPM will use the SHA-256 hash algorithm to extend measurements into the TPM PCRs during BIOS boot.</p> <p>By default, the SHA-256 option is enabled.</p>
Clear	<p>Enables to clear the TPM owner information and returns the TPM to the default state.</p> <p>By default, the Clear option is disabled.</p>
PPI ByPass for Clear Commands	<p>Controls the TPM Physical Presence Interface (PPI).</p> <p>By default, the PPI ByPass for clear Commands option is disabled.</p>
Intel Total Memory Encryption	
Total Memory Encryption	<p>Enable or disable you to protect memory from physical attacks including freeze spray, probing DDR to read the cycles, and others.</p> <p>By default, the Total Memory Encryption option is disabled.</p>
Chassis intrusion	<p>Controls the chassis intrusion feature.</p> <p>By default, the On-Silent option is enabled.</p>
SMM Security Mitigation	<p>Enable or disable SMM Security Mitigation.</p> <p>By default, the option is enabled.</p>

Table 11. System setup options—Security menu (continued)

Security	
Data Wipe on Next Boot	
Start Data Wipe	Enable or disable the data wipe on next boot. By default, the option is enabled.
Absolute	Enable or disable or permanently disable the BIOS module interface of the optional Absolute Persistence Module service from Absolute software. By default, the option is enabled.
UEFI Boot Path Security	Controls whether or not the computer will prompt the user to enter the admin password (if set) when booting to a UEFI boot device from the F12 boot menu. By default, the Always Except Internal HDD option is enabled.

Table 12. System setup options—Passwords menu

Passwords	
Admin Password	Set, change, or delete the administrator password.
System Password	Set, change, or delete the computer password.
NVMe SSD0	Set, change, or delete the NVMe SSD0 password.
Password Configuration	
Upper Case Letter	Reinforces password must have at least one upper case letter. By default, the option is disabled.
Lower Case Letter	Reinforces password must have at least one lower case letter. By default, the option is disabled.
Digit	Reinforces password must have at least one digit. By default, the option is disabled.
Special Character	Reinforces password must have at least one special character. By default, the option is disabled.
Minimum Characters	Set the minimum characters allowed for password.
Password Bypass	When enabled, this always prompts for computer and internal hard drive passwords when powered on from the off state. By default, the Disabled option is enabled.
Password Changes	
Enable Non-Admin Password Changes	Enable or disable to change computer and hard drive password without the need for admin password. By default, the option is enabled.
Admin Setup Lockout	
Enable Admin Setup Lockout	Enables administrators control over how their users can or cannot access BIOS setup. By default, the option is disabled.
Master Password Lockout	
Enable Master Password Lockout	When enabled, this will disable the master password support. By default, the option is disabled.
Allow Non-Admin PSID Revert	

Table 12. System setup options—Passwords menu (continued)

Passwords	
Enable Allow Non-Admin PSID Revert	Controls access to the Physical Security ID (PSID) revert of NVMe hard-drives from the Dell Security Manager prompt. By default, the option is disabled.

Table 13. System setup options—Update, Recovery menu

Update, Recovery	
UEFI Capsule Firmware Updates	Enable or disable BIOS updates through UEFI capsule update packages. By default, the option is enabled.
BIOS Recovery from Hard Drive	Enables the user to recover from certain corrupted BIOS conditions from a recovery file on the user primary hard drive or an external USB key. By default, the option is enabled.
BIOS Downgrade	
Allow BIOS Downgrade	Enable or disable the flashing of the computer firmware to previous revision is blocked. By default, the option is enabled.
SupportAssist OS Recovery	Enable or disable the boot flow for SupportAssist OS Recovery tool in the event of certain computer errors. By default, the option is enabled.
BISOConnect	Enable or disable cloud Service OS recovery if the main operating system fails to boot with the number of failures equal to or greater than the value specified by the Auto OS Recovery Threshold setup option and local Service OS does not boot or is not installed. By default, the option is enabled.
Dell Auto OS Recovery Threshold	Controls the automatic boot flow for SupportAssist System Resolution Console and for Dell OS Recovery Tool. By default, the threshold value is set to 2.

Table 14. System setup options—System Management menu

System Management	
Service Tag	Display the Service Tag of the computer.
Asset Tag	Create a computer Asset Tag.
AC Behavior	
Wake on AC	Enable or disable the wake on AC option. By default, the option is disabled.
Wake on LAN	
Wake on LAN	Enable or disable the computer to power on by special LAN signals when it receives a wakeup signal from the WLAN. By default, the Disabled option is selected.
Auto on Time	Enable to set the computer to turn on automatically every day or on a preselected date and time. This option can be configured only if the Auto On Time is set to Everyday, Weekdays, or Selected Days. By default, the option is disabled.
Intel AMT Capability	Enable Intel Active Management Technology

Table 14. System setup options—System Management menu (continued)

System Management	
MEBx Hotkey	Allows the user to use Ctrl+P hotkey to access MEBx
USB Provision	When enabled, Intel AMT can be provisioned using the local provisioning file through a USB storage device

Table 15. System setup options—Keyboard menu

Keyboard	
Numlock Enable	Enable or disable the Numlock function when the computer boots. By default, the option is enabled.
Fn Lock Options	By default, the Fn lock option is enabled.
Keyboard Illumination	Enables to change the keyboard illumination settings. By default, the Bright option is enabled.
Keyboard Backlight Timeout on AC	Set the timeout value for the keyboard backlight when an AC adapter is connected to the computer. By default, the 10 seconds option is enabled.
Keyboard Backlight Timeout on Battery	Set the timeout value for the keyboard backlight when the is running only on battery power. By default, the 10 seconds option is enabled.
Device Configuration Hotkey Access	Manages whether you can access device configuration screens through hotkeys during computer startup. By default, the option is enabled.

Table 16. System setup options—Pre-boot Behavior menu

Pre-boot Behavior	
Adapter Warnings	
Enable Adapter Warnings	Enable or disable the warning messages during boot when the adapters with less power capacity are detected. By default, the option is enabled.
Warning and Errors	Enable or disable the action to be done when a warning or error is encountered. By default, the Prompt on Warnings and Errors option is enabled.
Fastboot	Enable to set the speed of the boot process. By default, the Minimal option is enabled.
Extend BIOS POST Time	Set the BIOS POST time. By default, the 0 seconds option is enabled.
MAC Address Pass-Through	Replaces the external NIC MAC address with the selected MAC address from the computer. By default, the System Unique MAC Address option is enabled.

Table 17. System setup options—Performance menu

Performance	
Multi Core Support	
Active Cores	Enables to change the number of CPU cores available to the operating system. By default, the All Cores options is enabled.

Table 17. System setup options—Performance menu (continued)

Performance	
Intel SpeedStep	
Enable Intel SpeedStep Technology	Enables the computer to dynamically adjust processor voltage and core frequency, decreasing average power consumption and heat production. By default, the option is enabled.
C-States Control	
Enable C-State Control	Enable or disable additional processor sleep states. By default, the option is enabled.
Intel TurbocBoost Technology	
Enable Intel Turbo Boost Technology	Enable or disable Intel TurboBoost mode of the processor. By default, the option is enabled.
Intel Hyper-Threading Technology	
Enable Intel Hyper-Threading Technology	Enable or disable Hyper-Threading in the processor. By default, the option is enabled.
Dynamic Tuning:Machine Learning	
Enable Dynamic Tuning:Machine Learning	Enables the operating system capability to enhance dynamic power tuning capabilities based on detected workloads. By default, the option is disabled.

Table 18. System setup options—System Logs menu

System Logs	
BIOS Event Log	
Clear Bios Event Log	Display BIOS events. By default, the Keep option is enabled.
Thermal Event Log	
Clear Thermal Event Log	Display Thermal events. By default, the Keep option is enabled.
Power Event Log	
Clear Power Event Log	Display power events. By default, the Keep option is enabled.
License Information	Displays the license information of the computer.

Updating the BIOS

Updating the BIOS in Windows

About this task

 **CAUTION:** If BitLocker is not suspended before updating the BIOS, the next time you reboot the system it will not recognize the BitLocker key. You will then be prompted to enter the recovery key to progress and the system will ask for this on each reboot. If the recovery key is not known this can result in data loss or an

unnecessary operating system re-install. For more information on this subject, search in the Knowledge Base Resource at www.dell.com/support.

Steps

1. Go to www.dell.com/support.
2. Click **Product support**. In the **Search support** box, enter the Service Tag of your computer, and then click **Search**.
 **NOTE:** If you do not have the Service Tag, use the SupportAssist feature to automatically identify your computer. You can also use the product ID or manually browse for your computer model.
3. Click **Drivers & Downloads**. Expand **Find drivers**.
4. Select the operating system installed on your computer.
5. In the **Category** drop-down list, select **BIOS**.
6. Select the latest version of BIOS, and click **Download** to download the BIOS file for your computer.
7. After the download is complete, browse the folder where you saved the BIOS update file.
8. Double-click the BIOS update file icon and follow the on-screen instructions.
For more information, search in the Knowledge Base Resource at www.dell.com/support.

Updating the BIOS in Linux and Ubuntu

To update the system BIOS on a computer that is installed with Linux or Ubuntu, see the knowledge base article [000131486](https://www.dell.com/support/article/000131486) at www.dell.com/support.

Updating the BIOS using the USB drive in Windows

About this task

 **CAUTION:** If BitLocker is not suspended before updating the BIOS, the next time you reboot the system it will not recognize the BitLocker key. You will then be prompted to enter the recovery key to progress and the system will ask for this on each reboot. If the recovery key is not known this can result in data loss or an unnecessary operating system re-install. For more information on this subject, search in the Knowledge Base Resource at www.dell.com/support.

Steps

1. Follow the procedure from step 1 to step 6 in [Updating the BIOS in Windows](#) to download the latest BIOS setup program file.
2. Create a bootable USB drive. For more information, search in the Knowledge Base Resource at www.dell.com/support.
3. Copy the BIOS setup program file to the bootable USB drive.
4. Connect the bootable USB drive to the computer that needs the BIOS update.
5. Restart the computer and press **F12**.
6. Select the USB drive from the **One Time Boot Menu**.
7. Type the BIOS setup program filename and press **Enter**.
The **BIOS Update Utility** appears.
8. Follow the on-screen instructions to complete the BIOS update.

Updating the BIOS from the F12 One-Time boot menu

Update your computer BIOS using the BIOS update.exe file that is copied to a FAT32 USB drive and booting from the F12 One-Time boot menu.

About this task

 **CAUTION:** If BitLocker is not suspended before updating the BIOS, the next time you reboot the system it will not recognize the BitLocker key. You will then be prompted to enter the recovery key to progress and the

system will ask for this on each reboot. If the recovery key is not known this can result in data loss or an unnecessary operating system re-install. For more information on this subject, search in the Knowledge Base Resource at www.dell.com/support.

BIOS Update

You can run the BIOS update file from Windows using a bootable USB drive or you can also update the BIOS from the F12 One-Time boot menu on the computer.

Most of the Dell computers built after 2012 have this capability, and you can confirm by booting your computer to the F12 One-Time Boot Menu to see if BIOS FLASH UPDATE is listed as a boot option for your computer. If the option is listed, then the BIOS supports this BIOS update option.

 **NOTE:** Only computers with BIOS Flash Update option in the F12 One-Time boot menu can use this function.

Updating from the One-Time boot menu

To update your BIOS from the F12 One-Time boot menu, you need the following:

- USB drive formatted to the FAT32 file system (key does not have to be bootable)
- BIOS executable file that you downloaded from the Dell Support website and copied to the root of the USB drive
- AC power adapter that is connected to the computer
- Functional computer battery to flash the BIOS

Perform the following steps to perform the BIOS update flash process from the F12 menu:

 **CAUTION:** Do not turn off the computer during the BIOS update process. The computer may not boot if you turn off your computer.

Steps

1. From a turn off state, insert the USB drive where you copied the flash into a USB port of the computer.
2. Turn on the computer and press F12 to access the One-Time Boot Menu, select BIOS Update using the mouse or arrow keys then press Enter.
The flash BIOS menu is displayed.
3. Click **Flash from file**.
4. Select external USB device.
5. Select the file and double-click the flash target file, and then click **Submit**.
6. Click **Update BIOS**. The computer restarts to flash the BIOS.
7. The computer will restart after the BIOS update is completed.

System and setup password

Table 19. System and setup password

Password type	Description
System password	Password that you must enter to log in to your system.
Setup password	Password that you must enter to access and make changes to the BIOS settings of your computer.

You can create a system password and a setup password to secure your computer.

 **CAUTION:** The password features provide a basic level of security for the data on your computer.

 **CAUTION:** Anyone can access the data that is stored on your computer if it is not locked and left unattended.

 **NOTE:** System and setup password feature is disabled.

Assigning a system setup password

Prerequisites

You can assign a new **System or Admin Password** only when the status is in **Not Set**.

About this task

To enter the system setup, press F12 immediately after a power-on or reboot.

Steps

1. In the **System BIOS** or **System Setup** screen, select **Security** and press Enter.
The **Security** screen is displayed.
2. Select **System/Admin Password** and create a password in the **Enter the new password** field.
Use the following guidelines to assign the system password:
 - A password can have up to 32 characters.
 - At least one special character: ! " # \$ % & ' () * + , - . / : ; < = > ? @ [\] ^ _ ` { | }
 - Numbers 0 through 9.
 - Upper case letters from A to Z.
 - Lower case letters from a to z.
3. Type the system password that you entered earlier in the **Confirm new password** field and click **OK**.
4. Press Esc and save the changes as prompted by the pop-up message.
5. Press Y to save the changes.
The computer restarts.

Deleting or changing an existing system setup password

Prerequisites

Ensure that the **Password Status** is Unlocked (in the System Setup) before attempting to delete or change the existing System and/or Setup password. You cannot delete or change an existing System or Setup password, if the **Password Status** is Locked.

About this task

To enter the System Setup, press F12 immediately after a power-on or reboot.

Steps

1. In the **System BIOS** or **System Setup** screen, select **System Security** and press Enter.
The **System Security** screen is displayed.
2. In the **System Security** screen, verify that **Password Status** is **Unlocked**.
3. Select **System Password**, update, or delete the existing system password, and press Enter or Tab.
4. Select **Setup Password**, update, or delete the existing setup password, and press Enter or Tab.
 **NOTE:** If you change the System and/or Setup password, reenter the new password when prompted. If you delete the System and/or Setup password, confirm the deletion when prompted.
5. Press Esc and a message prompts you to save the changes.
6. Press Y to save the changes and exit from System Setup.
The computer restarts.

Clearing CMOS settings

About this task

 **CAUTION:** Clearing CMOS settings will reset the BIOS settings on your computer.

Steps

1. Remove the [base cover](#).
2. Disconnect the battery cable from the system board.
3. Remove the [coin-cell battery](#).
4. Wait for one minute.
5. Replace the [coin-cell battery](#).
6. Connect the battery cable to the system board.
7. Replace the [base cover](#).

Clearing BIOS (System Setup) and System passwords

About this task

To clear the system or BIOS passwords, contact Dell technical support as described at www.dell.com/contactdell.

 **NOTE:** For information on how to reset Windows or application passwords, refer to the documentation accompanying Windows or your application.

Troubleshooting

Handling swollen Lithium-ion batteries

Like most laptops, Dell laptops use lithium-ion batteries. One type of lithium-ion battery is the lithium-ion polymer battery. Lithium-ion polymer batteries have increased in popularity in recent years and have become standard in the electronics industry due to customer preferences for a slim form factor (especially with newer ultra-thin laptops) and long battery life. Inherent to lithium-ion polymer battery technology is the potential for swelling of the battery cells.

Swollen battery may impact the performance of the laptop. To prevent possible further damage to the device enclosure or internal components leading to malfunction, discontinue the use of the laptop and discharge it by disconnecting the AC adapter and letting the battery drain.

Swollen batteries should not be used and should be replaced and disposed of properly. We recommend contacting Dell product support for options to replace a swollen battery under the terms of the applicable warranty or service contract, including options for replacement by a Dell authorized service technician.

The guidelines for handling and replacing Lithium-ion batteries are as follows:

- Exercise caution when handling Lithium-ion batteries.
- Discharge the battery before removing it from the system. To discharge the battery, unplug the AC adapter from the system and operate the system only on battery power. When the system will no longer power on when the power button is pressed, the battery is fully discharged.
- Do not crush, drop, mutilate, or penetrate the battery with foreign objects.
- Do not expose the battery to high temperatures, or disassemble battery packs and cells.
- Do not apply pressure to the surface of the battery.
- Do not bend the battery.
- Do not use tools of any type to pry on or against the battery.
- If a battery gets stuck in a device as a result of swelling, do not try to free it as puncturing, bending, or crushing a battery can be dangerous.
- Do not attempt to reassemble a damaged or swollen battery into a laptop.
- Swollen batteries that are covered under warranty should be returned to Dell in an approved shipping container (provided by Dell)—this is to comply with transportation regulations. Swollen batteries that are not covered under warranty should be disposed of at an approved recycling center. Contact Dell product support at <https://www.dell.com/support> for assistance and further instructions.
- Using a non-Dell or incompatible battery may increase the risk of fire or explosion. Replace the battery only with a compatible battery purchased from Dell that is designed to work with your Dell computer. Do not use a battery from other computers with your computer. Always purchase genuine batteries from <https://www.dell.com> or otherwise directly from Dell.

Lithium-ion batteries can swell for various reasons such as age, number of charge cycles, or exposure to high heat. For more information on how to improve the performance and lifespan of the laptop battery and to minimize the possibility of occurrence of the issue, search Dell Laptop Battery in the Knowledge Base Resource at www.dell.com/support.

Dell SupportAssist Pre-boot System Performance Check diagnostics

About this task

SupportAssist diagnostics (also known as system diagnostics) performs a complete check of your hardware. The Dell SupportAssist Pre-boot System Performance Check diagnostics is embedded with the BIOS and is launched by the BIOS internally. The embedded system diagnostics provides a set of options for particular devices or device groups allowing you to:

- Run tests automatically or in an interactive mode
- Repeat tests
- Display or save test results

- Run thorough tests to introduce additional test options to provide extra information about the failed device(s)
- View status messages that inform you if tests are completed successfully
- View error messages that inform you of problems encountered during testing

NOTE: Some tests for specific devices require user interaction. Always ensure that you are present at the computer terminal when the diagnostic tests are performed.

For more information, see <https://www.dell.com/support/kbdoc/000180971>.

Running the SupportAssist Pre-Boot System Performance Check

Steps

1. Turn on your computer.
2. As the computer boots, press the F12 key as the Dell logo appears.
3. On the boot menu screen, select the **Diagnostics** option.
4. Click the arrow at the bottom left corner.
Diagnostics front page is displayed.
5. Click the arrow in the lower-right corner to go to the page listing.
The items detected are listed.
6. To run a diagnostic test on a specific device, press Esc and click **Yes** to stop the diagnostic test.
7. Select the device from the left pane and click **Run Tests**.
8. If there are any issues, error codes are displayed.
Note the error code and validation number and contact Dell.

Built-in self-test (BIST)

M-BIST

M-BIST (Built In Self-Test) is the system board's built-in self-test diagnostics tool that improves the diagnostics accuracy of system board embedded controller (EC) failures.

NOTE: M-BIST can be manually initiated before POST (Power On Self Test).

How to run M-BIST

NOTE: M-BIST must be initiated on the system from a power-off state either connected to AC power or with battery only.

1. Press and hold both the **M** key on the keyboard and the **power button** to initiate M-BIST.
2. With both the **M** key and the **power button** held down, the battery indicator LED may exhibit two states:
 - a. OFF: No fault detected with the system board
 - b. AMBER: Indicates a problem with the system board
3. If there is a failure with the system board, the battery status LED will flash one of the following error codes for 30 seconds:

Table 20. LED error codes

Blinking Pattern		Possible Problem
Amber	White	
2	1	CPU Failure
2	8	LCD Power Rail Failure
1	1	TPM Detection Failure
2	4	Unrecoverable SPI Failure

4. If there is no failure with the system board, the LCD will cycle through the solid color screens described in the LCD-BIST section for 30 seconds and then power off.

LCD Power rail test (L-BIST)

L-BIST is an enhancement to the single LED error code diagnostics and is automatically initiated during POST. L-BIST will check the LCD power rail. If there is no power being supplied to the LCD (i.e., the L-BIST circuit fails), the battery status LED will flash either an error code [2,8] or an error code [2,7].

NOTE: If L-BIST fails, LCD-BIST cannot function as no power will be supplied to the LCD.

How to invoke L-BIST Test:

1. Press the power button to start the system.
2. If the system does not start up normally, look at the battery status LED:
 - If the battery status LED flashes an error code [2,7], the display cable may not be connected properly.
 - If the battery status LED flashes an error code [2,8], there is a failure on the LCD power rail of the system board, hence there is no power supplied to the LCD.
3. For cases, when a [2,7] error code is shown, check to see if the display cable is properly connected.
4. For cases when a [2,8] error code is shown, replace the system board.

LCD Built-in Self Test (BIST)

Dell laptops have a built-in diagnostic tool that helps you determine if the screen abnormality you are experiencing is an inherent problem with the LCD (screen) of the Dell laptop or with the video card (GPU) and PC settings.

When you notice screen abnormalities like flickering, distortion, clarity issues, fuzzy or blurry image, horizontal or vertical lines, color fade etc., it is always a good practice to isolate the LCD (screen) by running the Built-In Self Test (BIST).

How to invoke LCD BIST Test

1. Power off the Dell laptop.
2. Disconnect any peripherals that are connected to the laptop. Connect only the AC adapter (charger) to the laptop.
3. Ensure that the LCD (screen) is clean (no dust particles on the surface of the screen).
4. Press and hold **D** key and **Power on** the laptop to enter LCD built-in self test (BIST) mode. Continue to hold the D key, until the system boots up.
5. The screen will display solid colors and change colors on the entire screen to white, black, red, green, and blue twice.
6. Then it will display the colors white, black and red.
7. Carefully inspect the screen for abnormalities (any lines, fuzzy color or distortion on the screen).
8. At the end of the last solid color (red), the system will shut down.

NOTE: Dell SupportAssist Pre-boot diagnostics upon launch, initiates an LCD BIST first, expecting a user intervention confirm functionality of the LCD.

System-diagnostic lights

This section lists the system-diagnostic lights of your Precision 3470.

Table 21. System-diagnostic lights

Blinking pattern		Problem description	Suggested resolution
Amber	White		
1	1	TPM detection failure	Replace the system board.
1	2	Unrecoverable SPI Flash Failure	Replace the system board.
1	5	EC unable to program i-Fuse	Replace the system board.

Table 21. System-diagnostic lights (continued)

Blinking pattern		Problem description	Suggested resolution
Amber	White		
1	6	Generic catch-all for ungraceful EC code flow errors	Disconnect all power source (AC, battery, coin cell) and drain flea power by pressing and holding down power button for 3~5 seconds.
2	1	CPU failure	<ul style="list-style-type: none"> • Run the Dell Support Assist/Dell Diagnostics tool. • If problem persists, replace the system board.
2	2	System board failure (included BIOS corruption or ROM error)	<ul style="list-style-type: none"> • Flash latest BIOS version • If problem persists, replace the system board.
2	3	No memory/RAM detected	<ul style="list-style-type: none"> • Confirm that the memory module is installed properly. • If problem persists, replace the memory module.
2	4	Memory/RAM failure	<ul style="list-style-type: none"> • Reset and swap memory modules among the slots. • If problem persists, replace the memory module.
2	5	Invalid memory installed	<ul style="list-style-type: none"> • Reset and swap memory modules among the slots. • If problem persists, replace the memory module.
2	6	System board/Chipset Error	Replace the system board.
2	7	LCD failure (SBIOS message)	Replace the LCD module.
2	8	LCD failure (EC detection of power rail failure)	Replace the system board.
3	1	CMOS battery failure	<ul style="list-style-type: none"> • Reset the main battery connection. • If problem persists, replace the main battery.
3	2	PCI or Video card/chip failure	Replace the system board.
3	3	BIOS Recovery image not found	<ul style="list-style-type: none"> • Flash latest BIOS version • If problem persists, replace the system board.
3	4	BIOS Recovery image found but invalid	<ul style="list-style-type: none"> • Flash latest BIOS version • If problem persists, replace the system board.
3	5	Power rail failure	Replace the system board.
3	6	Flash corruption detected by SBIOS.	<ul style="list-style-type: none"> • Press power button for over 25 seconds to do

Table 21. System-diagnostic lights (continued)

Blinking pattern		Problem description	Suggested resolution
Amber	White		
			RTC reset. If problem persists, replace the system board. <ul style="list-style-type: none"> • Disconnect all power source (AC, battery, coin cell) and drain flea power by pressing and holding down power button 3~5 seconds to ensure all power are drained. • Run "BIOS recovery from USB", and the instructions are in the website Dell support. • If problem persists, replace the system board.
3	7	Timeout waiting on ME to reply to HECI message.	Replace the system board.

NOTE: Blinking 3-3-3 LEDs on Lock LED (Caps-Lock or Num-Lock), Power button LED (without Fingerprint reader), and Diagnostic LED indicates failure to provide input during LCD panel test on Dell SupportAssist Pre-boot System Performance. Check diagnostics.

Recovering the operating system

When your computer is unable to boot to the operating system even after repeated attempts, it automatically starts Dell SupportAssist OS Recovery.

Dell SupportAssist OS Recovery is a standalone tool that is preinstalled in all Dell computers installed with Windows operating system. It consists of tools to diagnose and troubleshoot issues that may occur before your computer boots to the operating system. It enables you to diagnose hardware issues, repair your computer, back up your files, or restore your computer to its factory state.

You can also download it from the Dell Support website to troubleshoot and fix your computer when it fails to boot into their primary operating system due to software or hardware failures.

For more information about the Dell SupportAssist OS Recovery, see *Dell SupportAssist OS Recovery User's Guide* at www.dell.com/serviceabilitytools. Click **SupportAssist** and then, click **SupportAssist OS Recovery**.

Real-Time Clock (RTC Reset)

The Real Time Clock (RTC) reset function allows you or the service technician to recover Dell systems from No POST/No Power/No Boot situations. The legacy jumper enabled RTC reset has been retired on these models.

Start the RTC reset with the system powered off and connected to AC power. Press and hold the power button for thirty (30) seconds

. The system RTC Reset occurs after you release the power button.

Auto RTC reset

The auto RTC reset feature automates the manual process of the RTC recovery function from a No Power or No POST failures. When two instances of No Power, No POST issues are detected, the computer automatically attempts an RTC Reset.

Backup media and recovery options

It is recommended to create a recovery drive to troubleshoot and fix problems that may occur with Windows. Dell proposes multiple options for recovering Windows operating system on your Dell PC. For more information, see [Dell Windows Backup Media and Recovery Options](#).

WiFi power cycle

About this task

If your computer is unable to access the internet due to WiFi connectivity issues a WiFi power cycle procedure may be performed. The following procedure provides the instructions on how to conduct a WiFi power cycle:

 **NOTE:** Some ISPs (Internet Service Providers) provide a modem/router combo device.

Steps

1. Turn off your computer.
2. Turn off the modem.
3. Turn off the wireless router.
4. Wait for 30 seconds.
5. Turn on the wireless router.
6. Turn on the modem.
7. Turn on your computer.

Drain residual flea power (perform hard reset)

About this task

Flea power is the residual static electricity that remains in the computer even after it has been powered off and the battery is removed.

For your safety, and to protect the sensitive electronic components in your computer, you are requested to drain residual flea power before removing or replacing any components in your computer.

Draining residual flea power, also known as a performing a "hard reset", is also a common troubleshooting step if your computer does not power on or boot into the operating system.

To drain residual flea power (perform a hard reset)

Steps

1. Turn off your computer.
2. Disconnect the power adapter from your computer.
3. Remove the base cover.
4. Remove the battery.
5. Press and hold the power button for 20 seconds to drain the flea power.
6. Install the battery.
7. Install the base cover.
8. Connect the power adapter to your computer.
9. Turn on your computer.



 **NOTE:** For more information about performing a hard reset, search in the Knowledge Base Resource at www.dell.com/support.

Getting help and contacting Dell

Self-help resources

You can get information and help on Dell products and services using these self-help resources:

Table 22. Self-help resources

Self-help resources	Resource location
Information about Dell products and services	www.dell.com
My Dell app	
Tips	
Contact Support	In Windows search, type <code>Contact Support</code> , and press Enter.
Online help for operating system	www.dell.com/support/windows www.dell.com/support/linux
Access top solutions, diagnostics, drivers and downloads, and learn more about your computer through videos, manuals and documents.	Your Dell computer is uniquely identified by a Service Tag or Express Service Code. To view relevant support resources for your Dell computer, enter the Service Tag or Express Service Code at www.dell.com/support . For more information on how to find the Service Tag for your computer, see Locate the Service Tag on your computer .
Dell knowledge base articles for a variety of computer concerns	<ol style="list-style-type: none"> 1. Go to www.dell.com/support. 2. On the menu bar at the top of the Support page, select Support > Knowledge Base. 3. In the Search field on the Knowledge Base page, type the keyword, topic, or model number, and then click or tap the search icon to view the related articles.

Contacting Dell

To contact Dell for sales, technical support, or customer service issues, see www.dell.com/contactdell.

 **NOTE:** Availability varies by country/region and product, and some services may not be available in your country/region.

 **NOTE:** If you do not have an active Internet connection, you can find contact information about your purchase invoice, packing slip, bill, or Dell product catalog.