

ICY BOX®

Quick installation guide: IB-2538StS

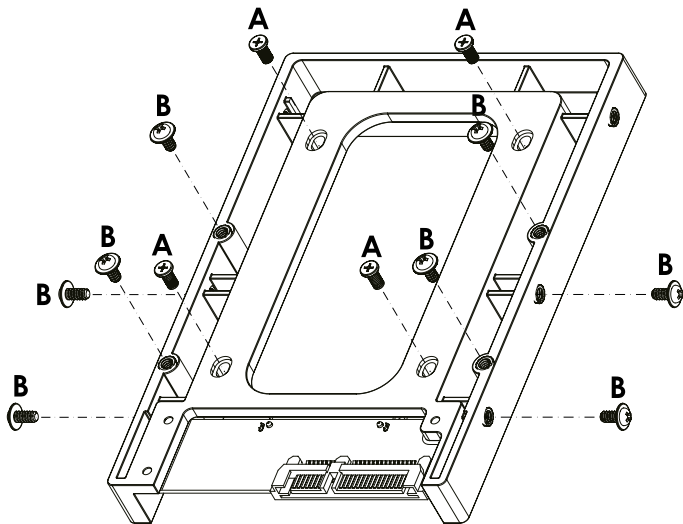

Screw type A

Specification: M3.0 x 6 mm

To fix the HDD/SSD on IB-2538StS

Screw type B

Specification: UNC 6-32 x 6 mm

To fix the IB-2538StS in a 3.5" bay

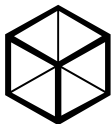

ICY BOX®

Kurzanleitung: IB-2538StS

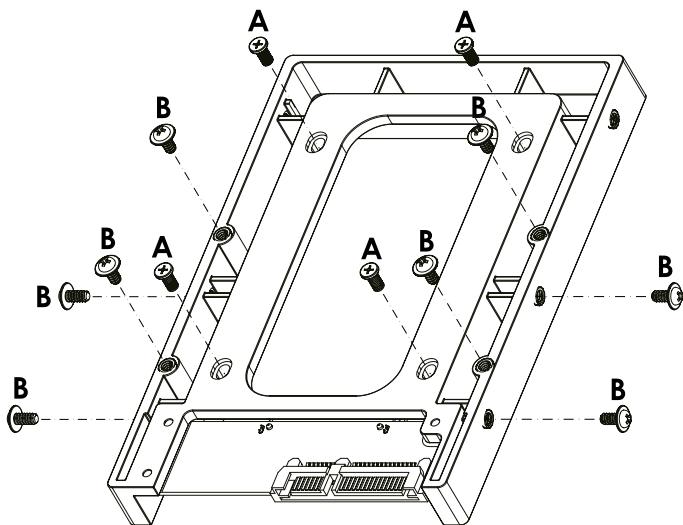

Schraubentyp A

Spezifikation: M3.0 x 6 mm

Zur Befestigung von HDD/SSD

Schraubentyp B

Spezifikation: UNC 6-32 x 6 mm

Zur Befestigung von IB-2358StS im 3,5" Schacht

