



OWNER'S MANUAL

Portable Bluetooth Speaker

Please read this manual carefully before operating your set and retain it for future reference.

MODELS

PL2/PL2W/PL2B/PL2M/PL2P/PL2C/PL2S



MFL71701928

2009_Rev02

www.lg.com

Copyright © 2020 LG Electronics Inc. All Rights Reserved.

Safety Information



CAUTION
RISK OF ELECTRIC SHOCK
DO NOT OPEN



CAUTION: TO REDUCE THE RISK OF ELECTRIC SHOCK DO NOT REMOVE COVER (OR BACK) NO USER-SERVICEABLE PARTS INSIDE REFER SERVICING TO QUALIFIED SERVICE PERSONNEL



This lightning flash with arrowhead symbol within an equilateral triangle is intended to alert the user to the presence of uninsulated dangerous voltage within the product's enclosure that may be of sufficient magnitude to constitute a risk of electric shock to persons.



The exclamation point within an equilateral triangle is intended to alert the user to the presence of important operating and maintenance (servicing) instructions in the literature accompanying the product.

WARNING: TO PREVENT FIRE OR ELECTRIC SHOCK HAZARD, DO NOT EXPOSE THIS PRODUCT TO RAIN OR MOISTURE.

CAUTION: The apparatus should not be exposed to water (dripping or splashing) and no objects filled with liquids, such as vases, should be placed on the apparatus.

WARNING: Do not install this equipment in a confined space such as a book case or similar unit.

CAUTION: Do not use high voltage products around this product. (ex. Electrical swatter) This product may malfunction due to electrical shock.

CAUTION: No naked flame sources, such as lighted candles, should be placed on the apparatus.

CAUTION: Do not block any ventilation openings. Install in accordance with the manufacturer's instructions.

Slots and openings in the cabinet are provided for ventilation and to ensure reliable operation of the product and to protect it from over heating. The openings should never be blocked by placing the product on a bed, sofa, rug or other similar surface. This product shall not be placed in a built-in installation such as a bookcase or rack unless proper ventilation is provided or the manufacturer's instruction has been adhered to.

CAUTION concerning the Power Cord

The Power Plug is the disconnecting device. In case of an emergency, the Power Plug must remain readily accessible.

Check the specification page of this owner's manual to be certain of the current requirements.

Do not overload wall outlets. Overloaded wall outlets, loose or damaged wall outlets, extension cords, frayed power cords, or damaged or cracked wire insulation are dangerous. Any of these conditions could result in electric shock or fire. Periodically examine the cord of your device, and if its appearance indicates damage or deterioration, unplug it, discontinue use of the device, and have the cord replaced with an exact replacement part by an authorized service center. Protect the power cord from physical or mechanical abuse, such as being twisted, kinked, pinched, closed in a door, or walked upon. Pay particular attention to plugs, wall outlets, and the point where the cord exits the device.

NOTICE: For safety marking information including product identification and supply ratings, please refer to the main label on the bottom or the other surface of the product.

CAUTION when using this product in environments of low humidity

- It may cause static electricity in environments of low humidity.
- It is recommended to use this product after touching any metal object which conducts electricity.

Symbols

~	Refers to alternating current (AC).
≡	Refers to direct current (DC).
⊞	Refers to class II equipment.
⏻	Refers to stand-by.
I	Refers to "ON" (power).
⚡	Refers to dangerous voltage.

Table of Contents

1 Getting Started

- 2 Safety Information
- 6 Unique features
- 6 Introduction
- 7 Front
- 8 Side

2 Operating

- 9 Charging the speaker
 - 9 – Charging with the AC adapter
 - 9 – Checking the charging status
- 10 Basic Operations
 - 10 – Using power button
 - 10 – Bluetooth Connection
 - 10 – Bluetooth LED status
 - 11 – Simple Operation Guide
- 12 Handsfree Function
- 13 Voice Command
- 14 Sound Effect
 - 14 – Setting Sound effect
- 15 Listening to Music from Your External Device
- 16 Using BLUETOOTH® wireless technology
 - 16 – Listening to music stored on the BLUETOOTH devices
- 19 Multi phone pairing
- 21 Using the "LG XBOOM" App
 - 21 – About "LG XBOOM" App
 - 21 – Install "LG XBOOM" App onto Your Bluetooth Device
 - 22 – Activate Bluetooth with "LG XBOOM" App
- 23 Dual Mode Connection
- 25 Other Operation
 - 25 – Resetting
 - 25 – Turn on/off the beep sound
 - 25 – Notice for Auto Power Off

3 Troubleshooting

- 26 Troubleshooting

4 Appendix

- 27 Trademarks and Licenses
- 27 Handling the Unit
- 28 Specifications

1

2

3

4

Unique features

Auto Power Off

This unit supports to turn off by itself for saving energy consumption. (Page 25)

AUX (Portable In)

Listen to music from your portable device. (Smart phone, Notebook, etc.)

BLUETOOTH®

Listen to music stored on your **Bluetooth** device.

LG XBOOM

LG XBOOM is an app designed to let you take control of some of LG's latest audio devices. (Only Android) (Page 21-22)

Dual Mode

You can enjoy the sound in stereo by using two speakers. For enjoying Dual Mode, you need to purchase another speaker.

Dual mode is only supported with the same model. (PL2 and PL2) (Page 23-24)

Introduction

Symbol used in this manual

! Note

Indicates special notes and operating features.

! Caution

Indicates cautions for preventing possible damages from abuse.

! Caution

Water-proof (IPX5)

This speaker is water-proof according to IPX5. IPX5 is "Degrees of protection against ingress of water" However, this system is not completely water-tight. Avoid the cases below.

- Do not use unit under water or other liquid.
- When battery is charging, do not expose the unit to water.
- When port is exposed to water, wipe off it with a soft dry cloth. Thoroughly dry it before using the speaker.
- Ports are not water-proof. Make sure close the port cover securely. Refer to below image.

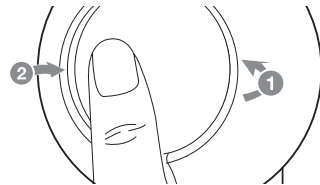

- Position port cover onto ① and securely press it in ②.

The water resistant performance of the system is based on our measurements under the conditions herein described. Note that malfunctions as a result of water immersion caused by misuse by the customer are not covered by the warranty.

Front

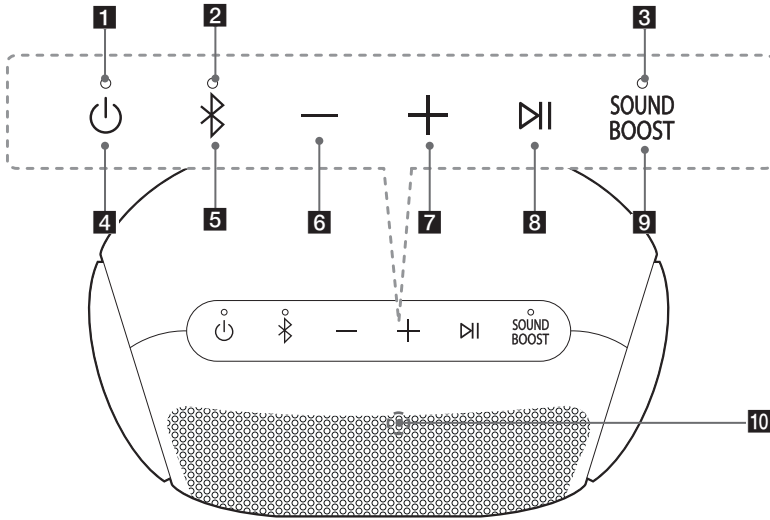

1 Power LED

2 Bluetooth LED

3 SOUND BOOST LED

4

Turns On / Off. Press it.

5

- Adds a **Bluetooth** device for multi phone pairing. (Press and hold for 2 seconds)
- Changes to **Bluetooth** mode in AUX mode. (Press)

* When you connect the 3.5 mm stereo cable, the function is changed to AUX mode.

- Press and hold for 7 seconds for **Bluetooth** Initialization.

6 —

Turn down the volume.

7 +

Turn up the volume.

8

- Plays, pauses or skips playback on the **Bluetooth** mode. (Page 11)

- Receives a call on the **Bluetooth** device. (Page 12)

- Mutes the sound on the AUX mode.

- Use voice command of your smart device. Press and hold the button for 2 seconds to use voice command. (Page 13)

9 SOUND BOOST

Changes sound effect. (Page 14)

10 Microphone

Side

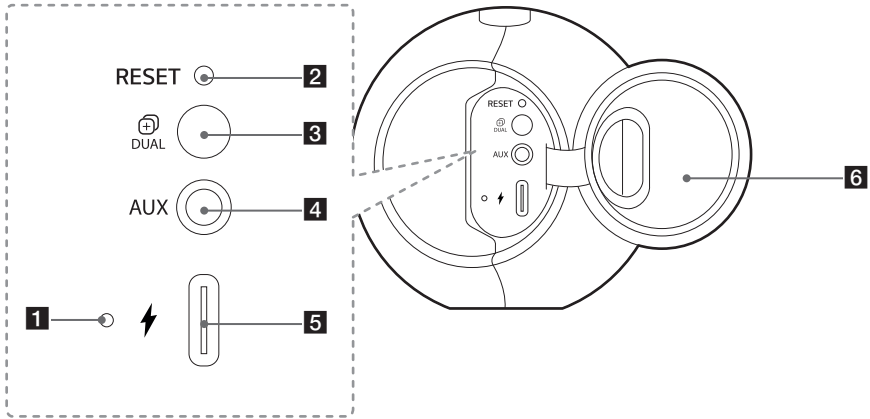

1 Battery LED

2 RESET button

3 DUAL

Connects two speakers for Dual Mode.
(Page 23-24)

4 AUX

Listens to music from your portable device.

5 (DC IN)

USB (C type) port for charging

6 Port cover

Charging the speaker

Charging with the AC adapter

This speaker uses built-in battery. Before using it, charge the battery by connecting the AC Adapter.

1. Connect the supplied USB cable to the AC adapter.
2. Connect the USB cable to ⚡ (DC IN) port of the speaker.
3. Plug the AC power cord into an AC outlet.

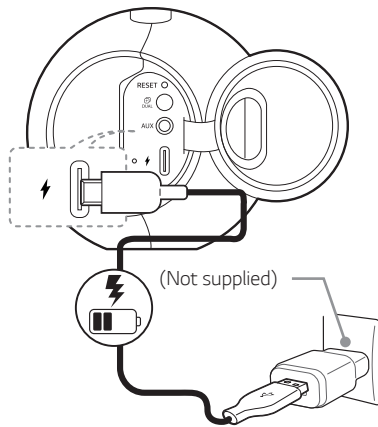

! Note

Operating time is approx. 10 hours. It is based on what fully charged the battery, continuous playback using 50 % volume level and turning off Sound Effect functions. It may vary depending on the battery status and operational conditions.

! Caution

AC adapter is not supplied. It is recommended that you use the 5 V AC adapter approved by LG Electronics Inc. (more than 2 A) with this speaker because of danger of explosion. If you do not use the recommended adapter, charging is unavailable or charging time may differ.

Checking the charging status

When speaker's battery is charging, you can check the charging status by Battery LED.

○ Off / ● On

LED	Description
○ ⚡	Battery is fully charged.
● ⚡	Battery is charging.

! Note

- When the power LED Blinks, the battery needs to be charged.
- If you listen to the music while charging, it will take longer to charge.
- When the speaker is not charging by overheating, Battery LED blinks quickly in red. And charging is stopped.
- If the Battery LED turns off while the battery is charging, it mean the battery is fully charged.

Basic Operations

Using power button

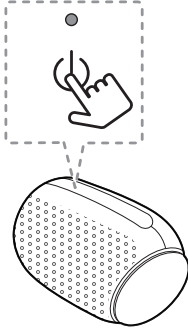

Power On / Off

Press the  button.

Bluetooth Connection

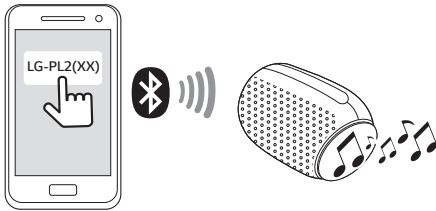



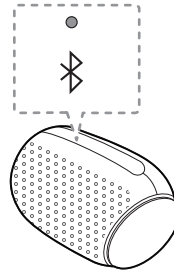

Play the desired music on the **Bluetooth** device. After pairing, you can control playback using the buttons on the unit. (Page 11, 16-18)

Bluetooth LED status

Check the **Bluetooth** LED blinks before connecting **Bluetooth** device.















LED	Status	Description
 	Bluetooth LED blinks with the sound.	Searching for Bluetooth device.
 	Bluetooth LED turns on with the sound.	Bluetooth device is connected.

! Note

- In AUX mode, **Bluetooth** LED turns off.
- Once pairing is performed, it does not need to be done again even if you turn off this unit.
- When switching AUX mode to **Bluetooth** mode, **Bluetooth** LED turns on but there is no sound.

Simple Operation Guide

Function	How to	Status
Power On	Press the  button.	Power LED turns on with the sound.
Power Off	Press the  button.	Power LED turns off with the sound.
Bluetooth pairing	When Bluetooth LED blinks, select LG-PL2 (XX) from device list on your Bluetooth device.	Bluetooth LED turns on with the sound.
Multi phone pairing	Press and hold  for 2 seconds to add another Bluetooth device.	During the search for another device, the Bluetooth LED blinks. After pairing, Bluetooth LED stays in white with the sound.
Volume control	Press  or  .	When this unit reaches minimum volume or maximum volume, you can hear beep sound.
Play / Pause	Press  .	-
Forward skip	Press  twice.	-
Backward skip	Press  three times.	-
Handsfree	Press  .	Receive and disconnect a call.
Voice Command	Press and hold  for 2 seconds	You can speak to operate the voice command of your smartphone through speaker's microphone
Sound effect	Press SOUND BOOST to select Standard or SOUND BOOST .	When you press the SOUND BOOST button, the sound effect is changed. LED Off is Standard and LED On is SOUND BOOST .
Dual Mode	Press the  DUAL button.	First hear beep sound at main speaker, and then at other speaker.
Bluetooth Initialization	Press and hold  for 7 seconds.	Power and Bluetooth LED blinks 4 times.

Note

- In Dual Mode, the multi phone pairing connection is not supported. (Page 23-24)
- You can adjust playback or volume by using your **Bluetooth** device.
- After initializing **Bluetooth**, it needs to reconnect with **Bluetooth** device. (In case of iOS devices, try to reconnect with **Bluetooth** device after deleted existing connection on **Bluetooth** device.)

Handsfree Function

You can receive incoming call on your **Bluetooth** device to this unit. Connect the unit to a **Bluetooth** device.

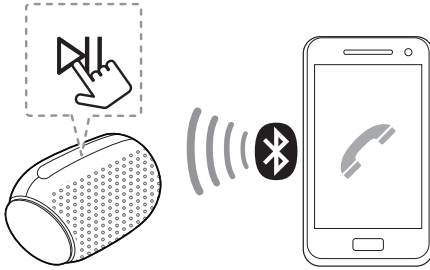

Function	How to
Receive a call.	Press ▷ .
End the call.	Press ▷ .
Reject a call.	Press and hold ▷ for 2 seconds
Toggle between speaker and your phone during a call.	Press and hold ▷ for 2 seconds

! Note

- During Handsfree Function, Voice Command is not supported.
- Only smartphone is available to use this function.
- To adjust the call volume, press **-**, **+** buttons on the unit.
- In Dual Mode, you can receive a call on only main speaker due to audio howling. (Page 23-24)
- On some **Bluetooth** devices, when an incoming call is received, it might ring the built-in ringtone, (ex. Android devices) The Built-in ringtone is not adjustable.
- In multi phone pairing mode, you can only receive the call of one of the connected devices on the speaker.
- If a call is connected between multi paired **Bluetooth** device, hands free does not work correctly.
- Even if you switch to AUX mode while in **Bluetooth** connection status, you can still use this function.
- When you receive a call by using the talk button on your phone, the call will be connected to your phone. If you want to talk via the speaker, It will need to be changed to speaker mode on your phone. (Only iOS devices)
- If you do not want to use this function, disable the **Bluetooth** setting on your phone. Connect **Bluetooth** again to use this mode.

Voice Command

You can speak to operate the voice command of your smartphone through speaker's microphone by using the voice command app or the Siri.

! Note

Make sure use the smart device that has voice command.

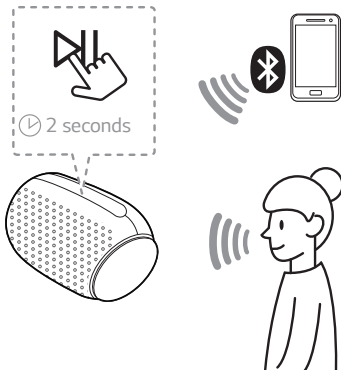

1. Connect the speaker to smart device through **Bluetooth**.
2. Press and hold the **▶|** button 2 seconds to active voice command of your smart device.
3. Activate voice command app as follow.
 - Android O/S : Select the voice command app.
 - iOS O/S : Siri activates automatically.
4. Make a request to voice command app or Siri through microphone of speaker.

! Note

- During Handsfree Function, Voice Command is not supported.
- When voice command time limit exceeded on smart devices, this function automatically cancel.
- It is recommended that you use the Google app (Google Assistant, Google Now etc.) when enjoying this function by using Android device. Google app is provided by Google. Some of location may not support by Google Policy.
- If you want to cancel Voice command mode, press and hold the **▶|** button 2 seconds again when this function is activating.
- For more information, refer to voice command app or Siri.
- Speaking at near microphone will increase the success rate.
- It may not work depending on the **Bluetooth** device.

Sound Effect

Sound Effect is optimally tuned in UK's high-end audio company MERIDIAN. MERIDIAN technology provides wide sound field and powerful sound. You can select a desired sound effect by using **SOUND BOOST** button.

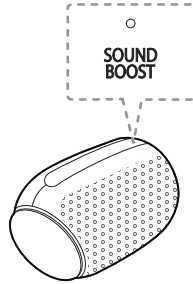

Setting Sound effect

○ Off / ● On

LED	Function	Description
○ SOUND BOOST	Standard	You can enjoy High-fidelity sound with balanced and natural.
● SOUND BOOST	SOUND BOOST	You can enjoy the wide sound field and powerful sound.

! Note

- When you turn the speaker back on, the last used option will be on.
- You can adjust sound effect using "LG XBOOM" app. (Only Android)
- When you select "Standard" sound effect, you can enjoy premium sound with MERIDIAN.
- Because fine-tune sound to provide optimal high-quality sound, It might be a little difference between sound effect modes.

Listening to Music from Your External Device

The unit can be used to listen to the music from many types of external device.

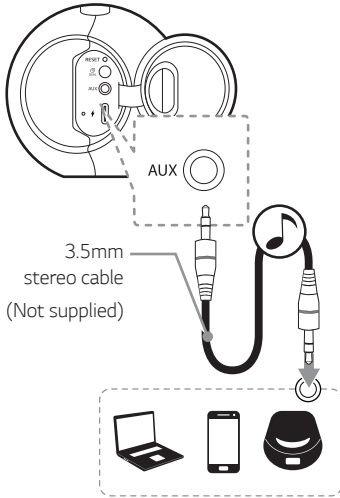

1. Turn the power on by pressing  button.
2. Connect the external device to the **AUX** (3.5mm) connector of the unit.
3. Turn the external device on and start playing.

Note

- When you connect the 3.5 mm stereo cable, the function is changed to **AUX** mode automatically.
- In **AUX** mode, speaker limits **Bluetooth** connection to prevent unintended **Bluetooth** connection.
- When the  button is pressed during this mode, it will switch to **Bluetooth** mode.
- When you use Dual Mode, the **AUX** mode is not supported.

Using BLUETOOTH® wireless technology

About BLUETOOTH

Bluetooth is wireless communication technology for short range connection.

The sound may be interrupted when the connection interfered by the other electronic wave or you connect the **Bluetooth** in the other rooms.

Connecting individual devices under **Bluetooth** wireless technology does not incur any charges. A mobile phone with **Bluetooth** wireless technology can be operated via the Cascade if the connection was made via **Bluetooth** wireless technology.

- Available Devices : Smart phone, Notebook, etc.
- Version : 5.0
- Codec : SBC, AAC

BLUETOOTH Profiles

In order to use **Bluetooth** wireless technology, devices must be able to interpret certain profiles. This unit is compatible with following profile.

A2DP (Advanced Audio Distribution Profile)
HFP (Handsfree Profile)

AVRCP (A/V Remote Control Profile)

Listening to music stored on the BLUETOOTH devices

Pairing your unit and BLUETOOTH device

Before you start the pairing procedure, make sure the **Bluetooth** feature is turned on in to your **Bluetooth** device. Refer to your **Bluetooth** device's user guide. Once a pairing operation is performed, it does not need to be performed again.

1. Turn on the unit then **Bluetooth** LED blinks with the sound.

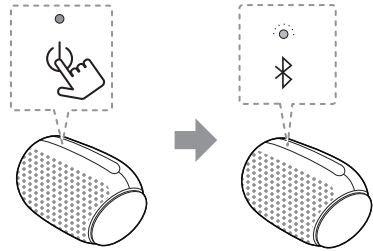

2. Operate the **Bluetooth** device and perform the pairing operation. When searching for this unit with the **Bluetooth** device, a list of the devices found may appear in the **Bluetooth** device display depending on the type of **Bluetooth** device. Your unit appears as "LG-PL2 (XX)".

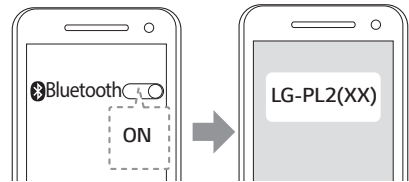

3. Select "LG-PL2 (XX)":

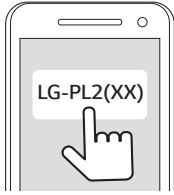

! Note

- XX means the last two digits of **Bluetooth** address. For example, if your unit has a **Bluetooth** address such as 9C:02:98:4A:F7:08, you will see "LG-PL2 (08)" on your **Bluetooth** device.
 - Depending on the **Bluetooth** device type, some devices have a different pairing way. For details about **Bluetooth** pairing, refer to your **Bluetooth** device manual.
4. When this unit is successfully connected with your **Bluetooth** device, **Bluetooth** LED will turn on with the sound.

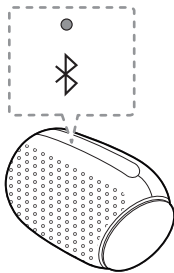

5. Listen to music.
To play a music stored on your **Bluetooth** device, refer to your **Bluetooth** device's user guide.

! Note

- When using **Bluetooth** technology, you have to make a connection between the unit and the **Bluetooth** device as close as possible and keep the distance close. However you may experience issues in the cases below :
 - There is an obstacle between the unit and the **Bluetooth** device.
 - There is a device using same frequency with **Bluetooth** technology such as a medical equipment, a microwave or a wireless LAN device.
- If **Bluetooth** connection does not work well, go to step 1 of "Pairing your unit and **BLUETOOTH** device" and try again.
- The sound may be interrupted when the connection interfered by the other electronic wave.
- Depending on the type of the device, you may not be able to use the **Bluetooth** function.
- You can enjoy **Bluetooth** function using Smart phone, Notebook, etc..
- The more distance between the unit and the **Bluetooth** device, the lower the sound quality becomes.
- **Bluetooth** connection will be disconnected when the unit is turned off or the **Bluetooth** device gets too far from the unit.
- When **Bluetooth** connection is disconnected, connect the **Bluetooth** device to the unit again.
- **Bluetooth** connection will be maintained even if you change the **Bluetooth** function to a different function.
- When you connect a **Bluetooth** device (iOS device etc.) to this unit or operate the device, the volume level will be synchronized between each device.
- When the unit is not connected, **Bluetooth** LED will blink.
- When you use the **Bluetooth** function, adjust the volume to a proper level on the **Bluetooth** device.

Controls connected Bluetooth device

You can control connected **Bluetooth** device from the unit; play, pause, skip, volume

Note

- Only Android OS and iOS is available to use this function.
- This function may not be supported depending on the **Bluetooth** device, or operated differently.

Multi phone pairing

The unit can be connected to 2 **Bluetooth** devices at the same time.

Pairing with Two Devices

1. Connect the unit to a **Bluetooth** device.
(Page 16-18)
2. When the **Bluetooth** device and unit are connected, press and hold  button for 2 seconds.

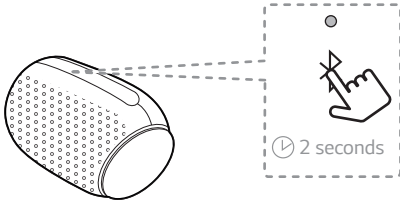

- Then **Bluetooth** LED blinks with the sound. The unit is changed to multi phone pairing mode.

3. Select "LG-PL2 (XX)" from device list on another **Bluetooth** device.

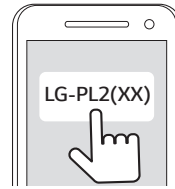

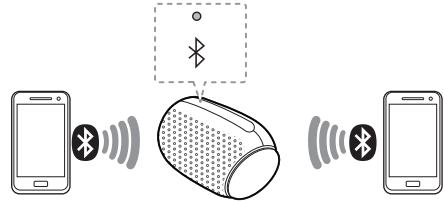

- Then the speaker is connection with 2 **Bluetooth** devices.

4. When connection of 2 **Bluetooth** devices are successful, **Bluetooth** LED will turn on.



! Note

- When you use Dual Mode, the multi phone pairing connection is not supported. Press  **DUAL** button to cancel Dual Mode.
- You can connect this unit with up to 2 **Bluetooth** devices simultaneously by using the same method as described on the previous page. If you want to connect new **Bluetooth** device with 2 **Bluetooth** devices connected, press and hold  button for 2 seconds.
- When the speaker is in the multi phone pairing mode, you will need to connect the other **Bluetooth** device and speaker within a few minutes (Approx. 1 minute). Otherwise multi phone pairing mode will be canceled.
- Multi phone pairing connection may not be supported depending on the connected device's specifications.
- Removable/detachable **Bluetooth** device (Ex :Dongle etc..) doesn't support multi phone pairing.
- Even if this speaker is connected with up to 2 **Bluetooth** devices, you cannot play and control music on both **Bluetooth** devices at same time. Stop the music if you want to play the other **Bluetooth**.
- After multi-pairing connection, it takes a little time for the music to be played depending on the **Bluetooth** devices.
- In case of multi phone pairing, automatically connection of 2 **Bluetooth** devices is not supported. Only one **Bluetooth** device will be automatically connected to the speaker. The other device should be connected manually.
- If you get out of **Bluetooth**'s effective distance without disconnecting **Bluetooth**, it may take a few minutes to connect other **Bluetooth** devices. But after power off and on, you can connect other **Bluetooth** devices without waiting.
- If you try to pair a new **Bluetooth** device when it is already connected to 2 **Bluetooth** devices, this speaker automatically disconnects one **Bluetooth** device. (The **Bluetooth** device in use is excluded from disconnection.)
- In case of multi-pairing, only one **Bluetooth** device that has control can use voice command.

Using the "LG XBOOM" App

! Note

- Only Android OS is available to use "LG XBOOM" app with this unit.
- It is recommended to use the latest version of app.

About "LG XBOOM" App

"LG XBOOM" app brings a suite of new features to this unit.

To enjoy more features, you are recommended to download and install free "LG XBOOM" app.

Install "LG XBOOM" App onto Your Bluetooth Device

There are two ways to install "LG XBOOM" App onto Your **Bluetooth** Device.

Install "LG XBOOM" App through QR code

1. Install "LG XBOOM" app through QR code. Use the scanning software to scan the QR code.



<Android>

2. Tap an icon for installation.

! Note

- Make sure that your **Bluetooth** device is connected to the Internet.
- Make sure that your **Bluetooth** device has a scanning software application. If you don't have one, download one from "Google Android Market (Google Play Store)".
- Depending on the area, QR code may not work.
- You can find the available application of this unit by using "LG Audio" app.
 - Android O/S: Ver 5.0 (or later)

Install “LG XBOOM” App through “Google Android Market (Google Play Store)”

1. Tap the “Google Android Market (Google Play Store)” icon.
2. In the search bar, type in the “LG XBOOM” and search it.
3. In the search result list, find and tap “LG XBOOM” to start downloading **Bluetooth** app.

! Note

- Make sure that your **Bluetooth** device is connected to the Internet.
- Make sure that your **Bluetooth** device is equipped with “Google Android Market (Google Play Store)”.

Activate Bluetooth with “LG XBOOM” App

“LG XBOOM” app helps to connect your **Bluetooth** device to this unit.

Tap “LG XBOOM” app icon on the home screen to open “LG XBOOM” app, and go to the main menu.

! Note

- “LG XBOOM” app will be available in the software version as follow;
 - Android O/S: Ver 5.0 (or later)
- Depending on the **Bluetooth** device, “LG XBOOM” app may not work.
- After connection of “LG XBOOM” app, music may be output from your **Bluetooth** device. In this case, try connecting procedure again.
- If you operate the other applications or change the settings on your **Bluetooth** device while using “LG XBOOM” app, “LG XBOOM” app may operate abnormally.
- When “LG XBOOM” app operates abnormally, check your **Bluetooth** device and the connection of “LG XBOOM” app and then try to connect again.
- Depending on the smart phone's operating system, you have some differences for “LG XBOOM” operation.
- Check **Bluetooth** setting on your **Bluetooth** device if “LG XBOOM” app connection does not work well.

Dual Mode Connection

You can enjoy the sound in stereo by using two speakers. For enjoying Dual Mode, you need to purchase another speaker.

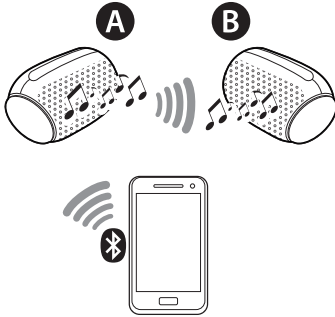

1. Press the each speaker's  **DUAL** button. Then the speakers are ready to Dual Mode.

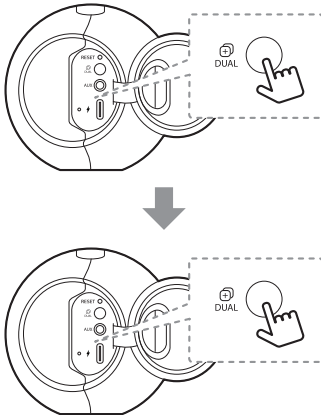

- Beep sound will be heard.

2. If two speakers are connected, Bluetooth LED of the Main speaker turns on and Bluetooth LED of the Other speaker turns off. First hear beep sound at main speaker, and then at other speaker.

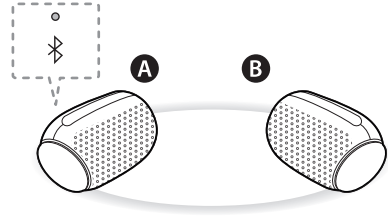

- **A** speaker : Main speaker is to set L (Left) channel and turns on **Bluetooth** LED.
- **B** speaker : Other speaker is set to R (Right) channel and turns off **Bluetooth** LED.

! Note

- It takes up to 1 minute to connect to Dual Mode.
- Using Dual Mode is limited to only PL2 Model and is unavailable on other Portable **Bluetooth** Speaker.
- If you are not connected to **Bluetooth** device, main speaker's **Bluetooth** LED blinks.
- The **A** speaker depends on MAC address of **Bluetooth**.

3. Play the desired music on the **Bluetooth** device.

! Note

- When you enjoy Dual Mode, Multi phone pairing is not supported.
 - Main speaker (A) connects only one **Bluetooth** device.
- In Dual Mode, you can connect only the main speaker(A) with the **Bluetooth** device.
- If you turn the power off and then on again, two speakers need to be reconnection for using Dual Mode.
- If the units fail to connect Dual Mode, go to step 1 and try again.
- When Dual Mode connection is on processing, you cannot search the units on other **Bluetooth** devices.
- When you disconnect Dual Mode connection, press **DUAL** buttons of one of the two speakers again.
- When you enjoy Dual Mode, you can adjust the Volume, Playback or Sound Effect of both main (A) and other (B) speakers at the same time.
- When you connect Dual Mode connection while using AUX mode, this speaker automatically changes to **Bluetooth** mode.
- In Dual Mode, you can receive a call on only main speaker due to audio howling.
- If you connect 3.5 mm stereo cable in Dual Mode, it will cancel Dual Mode and then change to AUX mode.
- To change the **Bluetooth** device in Dual Mode, press and hold **X** for 2 seconds to disconnect current **Bluetooth** device and connect to the desired **Bluetooth** device.
- When you connect a **Bluetooth** device (iOS device etc.) to this unit or operate the device, the volume level can be synchronized between each device.
- In Dual Mode, make the distance between the speakers as close as possible each other.
- Depending on network environment, the Dual Mode may not work well.
- In Dual Mode, you can only use voice command on the main speaker.
- Some mobile phones might not play music properly when you try to connect Dual Mode during playback.
- The speaker might not synchronize audio with video (ex. TV etc).
- Press **Power** button, **DUAL** button to cancel Dual Mode.

Other Operation

Resetting

If have a malfunction with the speaker, press the **RESET** button using an object like a thin pin. Then speaker turns off. Press **⏻** button to try turning on speaker again.

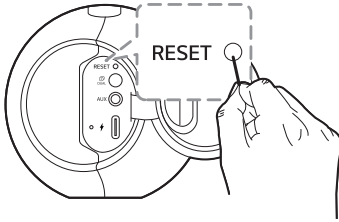

Turn on/off the beep sound

Set up the beep sound through "LG XBOOM" app:
"LG XBOOM" menu → [Setting] → [Beep Sound]

Notice for Auto Power Off

When the unit is in **Bluetooth** mode without music playback for 15 minutes or in **AUX** mode without button operation for 6 hours, this unit is turned off automatically.

The function can be turned on or off.

When setting is changed in the order as below, Power LED blinks 5 times with beep sound.

Function	How to
ON	Press and hold ⏻ , + for 2 seconds simultaneously.
OFF	Press and hold ⏻ , - for 2 seconds simultaneously.

! Note

- You can toggle this function on and off through "LG XBOOM" app. (Only Android)
- If the function was off, speaker will be off in this way that press the **⏻** button or battery is completely discharged

Troubleshooting

Problem	Cause & Correction
No Power.	<ul style="list-style-type: none"> • The battery is discharged. Recharge the battery. • Connect the unit to the power supply with the AC adapter.
No sound or sound distortion.	<ul style="list-style-type: none"> • The unit or your smart device's volume is set to minimum. Check and adjust the volume of the unit or Bluetooth device's volume. • When you use an external device at high volume, the sound quality may be deteriorated. Lower the volume of the devices. • If you use the unit for purposes other than listening to music, the sound quality may be lowered or the unit may not work properly.
Bluetooth pairing does not work well.	<ul style="list-style-type: none"> • Switch Bluetooth off and on again on your Bluetooth device, then try pairing again. • Be sure your Bluetooth device is on. • Remove the obstacle in the path of the Bluetooth device and the unit. • Depending on the type of the Bluetooth device or surrounding environment, your device may not be paired with the unit.
The unit does not operate normally.	<ul style="list-style-type: none"> • If the battery was fully discharged, the stored Bluetooth information can be deleted. Previous setting may not be saved when the unit's power is shut off. • In case of malfunction, please use the unit in proper place where the temperature or humidity is not so high or low. • In case of overload, power and Bluetooth LEDs blink white. Please turn the power off and then on again.
Above solutions do not work.	<ul style="list-style-type: none"> • Press the RESET button on speaker using an object like a thin pin. (Page 25)

Trademarks and Licenses



The **Bluetooth**® word mark and logos are registered trademarks owned by the Bluetooth SIG, Inc. and any use of such marks by LG Electronics is under license.

Other trademarks and trade names are those of their respective owners.

Handling the Unit

When shipping the unit

Please save the original shipping carton and packing materials. If you need to ship the unit, for maximum protection, re-pack the unit as it was originally packed at the factory.

Keeping the exterior surfaces clean

- Do not use volatile liquids such as insecticide spray near the unit.
- Wiping with strong pressure may damage the surface.
- Do not leave rubber or plastic products in contact with the unit for a long period of time.

Cleaning the unit

To clean the unit, use a soft, dry cloth. If the surfaces are extremely dirty, use a soft cloth lightly moistened with a mild detergent solution. Do not use strong solvents such as alcohol, benzine, or thinner, as these might damage the surface of the unit.

Specifications

General	
Power requirements	5 V  2 A (AC adapter) Built-in rechargeable battery
Power consumption	Refer to the main label.
Dimensions (W x H x D)	Approx. 126 mm X 82 mm X 80 mm
Operating temperature	5 °C to 35 °C
Operating humidity	5 % to 60 % RH
Water-proof	IPX5

Inputs	
AUX (Portable in)	0.5 Vrms (3.5 mm stereo jack)

Battery	
Battery capacity	1500 mAh
Operating time	Approx. 10 hours. It may vary depending on the battery status and operational conditions.
Charging time	Less than 4 hours (with AC Adapter). It can be varied depending on the conditions of the battery or operation.

- Design and specifications are subject to change without notice.

