

Guide

# HP Inclusive Design Guide

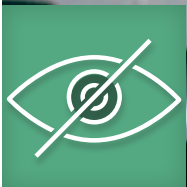

for HP Enterprise FutureSmart Printers,  
MFPs, and Digital Senders



# Accessibility for all customers is a high priority for HP



HP is committed to creating innovative designs and solutions that make our printers accessible and easy to use for all customers, including those with disabilities. With an extensive range of printing product lines, HP endeavors to include features for all-round usability, such as intuitive buttons and control panels, convenient paper tray and cartridge access, and remote configuration/management. Select printer lines include additional inclusive design features.



**Note:** To learn about the features for a specific printer, see the printer datasheet.

This guide explains features, configurations, and accessories that can make your HP printer easier to use, and can help accommodate various disabilities or challenges. The icons below are used later in this guide to match features and options with the type of benefit they provide.



## Vision benefit

Facilitates the ability to see for a broad range of people, including those with vision disabilities such as blindness, limited vision, and color blindness



## Reach and strength benefit

Enables access and reduces the amount of physical effort used when operating the HP Printer



## Language, cognitive, and learning benefit

Helps users by simplifying and streamlining tasks, and making user interactions more intuitive and easy to understand



## Fine motor skill benefit

Provides an easy alternative for tasks that typically require manual dexterity



## Hearing benefit

Helps users by providing adjustable volume and control panel messaging for troubleshooting

# Get started with HP Inclusive Design

## If you already have an HP printer...

Begin by checking the firmware version. Accessibility features and options vary by the type of control panel firmware (**FutureSmart 3** or **FutureSmart 4**). Use the following examples to identify the type of firmware that is installed on your printer.

### FutureSmart 3 control panels



### FutureSmart 4 control panels



Your printer's firmware version can also be verified by printing a configuration page from the printer control panel (From the Reports menu, select Configuration/Status Page and select the Configuration Page item, press OK button or Print.)

Review the next section to learn how to position your printer for easiest access. Then go to the section for your type of firmware (FutureSmart 3 or FutureSmart 4) to learn more and make the most of the inclusive design features and options that are available to you. Finally, at the end of this guide, you can review features and options by product type for a more comprehensive look.

## If you are shopping for a printer...

Check the information in this guide to identify the inclusive design features and options that you want, and refer to the product tables at the end of this guide. Contact your HP representative for more information.

# Learn about Printer Positioning

Find a location for the printer that will provide plenty of room for the doors and trays to open. For information about dimensions and environmental recommendations, go to [www.hp.com/support](http://www.hp.com/support) and search for the user guide for your printer.

Next, physically position your printer to make it accessible and convenient for users. For optimal access, use the following tips to position the printer:

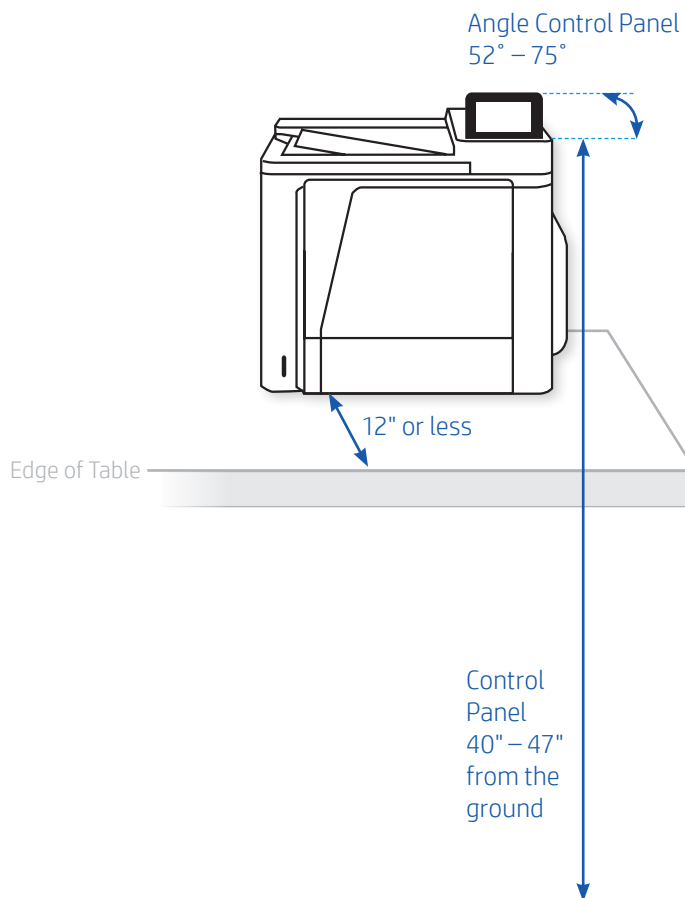

- Position the printer at a height that places the control panel between 40 and 47 inches (101.6 and 119.4 cm) from the ground. This is considered the ideal position for all users including those confined to a wheelchair.

**NOTE:** For some printers, you might need to use a table or a stand to meet the height requirements. Stands or paper tray/stand combinations are available for some printers. To check for and order genuine HP parts or accessories, go to [www.hp.com/buy/parts](http://www.hp.com/buy/parts). If you have a managed model, contact your managed service representative.

- If the printer is positioned on a table or stand, make sure that the printer is no more than 12 inches (30.5 cm) from the surface edge on which it is placed to ensure easy access to the control panel.
- Position adjustable touch screen control panels at an angle between 52° and 75° by tilting the display. This is considered the ideal position for all users to easily view or access the display.

# Learn about FutureSmart 3 Firmware Features

If you have FutureSmart 3 firmware, upgrade to FutureSmart 4 to increase accessibility features and add compatible accessories. For instructions on upgrading your firmware, see [Update firmware using a USB flash drive or the Embedded Web Server \(EWS\)](#).













**NOTE:** FutureSmart 4 firmware is not available for the following printers

- HP Color LaserJet Enterprise CP5525
- HP LaserJet Enterprise M506 (4-line display models)
- HP LaserJet Managed M506 series (4-line display models)
- HP Color LaserJet Enterprise M552
- HP Color LaserJet Enterprise M553 (4-line display models)
- HP Color LaserJet Managed M553 series (4-line display models)
- HP LaserJet Enterprise M601/602/603/604
- HP LaserJet Enterprise M605/M606 (4-line display models)

FutureSmart 3 firmware offers the following control panel configurations for visual display, sound, and timeout settings.

**Table 1: FutureSmart 3 firmware features**

Feature	Description	Type of assistance
<b>Fax speaker volume</b> (Fax models only)	Adjustable ring volume	  
<b>Control panel brightness</b> (select MFP models)	Adjustable display brightness	
<b>Virtual keyboard</b> (4.3" and 8" touchscreen control panels)	Touchscreen keyboard that appears on the printer control panel when input is needed	  
<b>Printer activity timeout</b> (select MFP models)	Adjustable timing for an inactive operation screen to automatically return to the Home screen. This allows the user more time to make decisions and enter commands	   

# Learn about FutureSmart 4 Firmware Features

If your printer has the latest version of FutureSmart 4 firmware installed, you already have several assistance features on the control panel.

**Table 2:** FutureSmart 4 firmware features

Feature	Description	Type of assistance
<b>Backlit LCD control panel</b> (Select models only)	Control panel illumination that provides optimal visibility in low light environments	 
<b>Virtual keyboard</b> (4.3" and 8" touchscreen control panels)	Touchscreen keyboard that appears on the printer control panel when input is needed	  
<b>Integrated keyboard</b> (Select Flow models only)	Physical keyboard under the control panel for convenient input of commands	   
<b>Accessory keyboard</b> (MFPs and select Digital Senders/Scanners)	BigKeys USB keyboard for larger keys and extended reach (with the optional HP Accessibility Kit)	   
<b>Auto Quick Set job commands</b>	Saved settings for common jobs. These are configured on the control panel or Embedded Web Server (EWS).	   
<b>High Contrast Mode<sup>2</sup></b>	Adjustable contrast between text and background	
<b>Invert Colors<sup>2</sup></b>	Option to switch the colors used for text and background	
<b>Screen Zoom<sup>2</sup></b>	Magnification of the content on the control panel	
<b>Button press volume</b>	Button-controlled volume adjustment (with optional HP Accessibility Assistant accessory installed)	  

<sup>2</sup> To learn how to configure this control panel feature, see [Configure the Accessibility app on the printer control panel](#).

# Learn about the HP Accessibility Kit

You can customize your FutureSmart 4 printer with an optional HP Accessibility Kit for better access and use.\*

(For compatible printer models, see the section at the end of this document, [Review Features and Options by Product.](#))

The kit includes a prop handle for reaching assistance, plus braille labels and an accessible keyboard for visual assistance.



## Accessible Keyboard

- BigKeys LX
- TAA Compliant



## Prop Handle

Polymer-based handle capable of:

- Adjusting the control panel
- Lifting the ADF
- Adjusting ADF guides
- Moving paper



## Braille labels

Self-adhesive Braille labels for trays, keyboard, USB port, power button, etc.



To order the HP Accessibility Kit, go to [www.hp.com/buy/parts](http://www.hp.com/buy/parts), and order part number **2TD64A**.

If you have a managed service model, contact your managed service representative.

\*Requires FutureSmart 4 firmware 4.5 or higher.

# Learn about the HP Accessibility Assistant

The HP Accessibility Assistant is a compact device that adds voice command and screen reader functions to your FutureSmart 4 printer.\* The Assistant is designed with intuitively shaped buttons and easy-access features, and you can activate session-based voice command with a single touch. A headset is included.



The HP Accessibility Assistant can be conveniently attached to your HP FutureSmart 4 printer\* or it can sit flush in the hardware integration pocket. It is compatible with HP enterprise-class devices that have 2.7", 4.3", or 8" control panels and the latest FutureSmart 4 firmware.

(For compatible printer models, see the section [Review Features and Options by Product.](#))

**Table 3:** HP Accessibility features

Feature	Description	Type of assistance
Voice command	Printer operation via verbal instructions. The HP Accessibility Assistant supports around 170 voice commands. Supported languages are English, French, Italian, German, and Spanish.	
Screen reader	Speech synthesizer that reads aloud the content on the control panel. Sound volume is adjustable.	

**Get a first-hand look with these videos**

- [HP Accessibility Assistant Installation](#)
- [HP Accessibility Assistant Button Functions](#)
- [HP Accessibility Assistant Voice Commands](#)

To learn more about the Accessibility Assistant, go to [www.hp.com/support/hpaa](http://www.hp.com/support/hpaa) and review the User Guide and Installation Guide.

To order the HP Accessibility Assistant, go to [www.hp.com/buy/parts](http://www.hp.com/buy/parts), and order part number **2MU474A**.

If you have a managed service model, contact your managed service representative.

\*See list of compatible printers on pages 9 to 11.



# Review Features and Options by Product

The following tables show the inclusive design features and options that are available for the listed printers and scanners.

**Table 4:** Multi-function printers - Enterprise

Enterprise Multi-Function Printers	FutureSmart 4	HP Accessibility Kit	HP Accessibility Assistant
HP Color LaserJet Enterprise MFP M577	Yes	Yes	Yes
HP Color LaserJet Enterprise MFP M680	Yes	Yes	No
HP Color LaserJet Enterprise MFP M681/682	Yes	Yes	Yes
HP Color LaserJet Enterprise Flow MFP M880	Yes	Yes	No
HP LaserJet Enterprise Color MFP M575	Yes	Yes	No
HP LaserJet Enterprise Color MFP M775	Yes	Yes	No
HP LaserJet Enterprise MFP M525	Yes	Yes	No
HP LaserJet Enterprise MFP M527	Yes	Yes	Yes
HP LaserJet Enterprise MFP M528	Yes	Yes	Yes
HP LaserJet Enterprise Flow MFP M528	Yes	Yes	Yes
HP LaserJet Enterprise MFP M630	Yes	Yes	No
HP LaserJet Enterprise MFP M631/632/633	Yes	Yes	Yes
HP LaserJet Enterprise MFP M725	Yes	Yes	No
HP LaserJet Enterprise Flow MFP M830	Yes	Yes	No
HP OfficeJet Enterprise Color MFP X585	Yes	Yes	No
HP PageWide Enterprise Color MFP 586	Yes	Yes	Yes
HP PageWide Enterprise Color MFP 780/785	Yes	Yes	Yes



**Table 5:** Multi-function printers - Managed

Managed Multi-Function Printers	FutureSmart 4	HP Accessibility Kit	HP Accessibility Assistant
HP Color LaserJet Managed MFP E57540 series	Yes	Yes	Yes
HP Color LaserJet Managed MFP E67550/E67560	Yes	Yes	Yes
HP Color LaserJet Managed MFP E67650/E67660	Yes	Yes	Yes
HP Color LaserJet Managed MFP E77422/E77428	Yes	Yes	Yes
HP Color LaserJet Managed MFP E77822/E77825/E77830	Yes	Yes	Yes
HP Color LaserJet Managed MFP E87640/E87650/E87660	Yes	Yes	Yes
HP Color LaserJet Managed MFP M575 series	Yes	Yes	No
HP Color LaserJet Managed MFP M577 series	Yes	Yes	Yes
HP Color LaserJet Managed MFP M680 series	Yes	Yes	No
HP Color LaserJet Managed MFP M775	Yes	Yes	No
HP Color LaserJet Managed MFP M880	Yes	Yes	No
HP LaserJet Managed MFP 725	Yes	Yes	No
HP LaserJet Managed MFP E52545 series	Yes	Yes	Yes
HP LaserJet Managed MFP E52645	Yes	Yes	Yes
HP LaserJet Managed Flow MFP E52645	Yes	Yes	Yes
HP LaserJet Managed MFP E62555/E62565/E62575	Yes	Yes	Yes
HP LaserJet Managed MFP E62655/E62665	Yes	Yes	Yes
HP LaserJet Managed Flow MFP E62665/E62675	Yes	Yes	Yes
HP LaserJet Managed MFP E72425/E72430	Yes	Yes	Yes
HP LaserJet Managed MFP E72525/E72530/E72535	Yes	Yes	Yes
HP LaserJet Managed MFP E82540/E82550/E82560	Yes	Yes	Yes
HP Color LaserJet Managed MFP E87640/E87650/E87660	Yes	Yes	Yes
HP LaserJet Managed MFP M525 series	Yes	Yes	No
HP LaserJet Managed MFP M527 series	Yes	Yes	Yes
HP LaserJet Managed MFP M630 series	Yes	Yes	No
HP LaserJet Managed MFP M830 series	Yes	Yes	No
HP PageWide Managed Color MFP E58650 series	Yes	Yes	Yes
HP PageWide Managed Color MFP E77650/E77660	Yes	Yes	Yes
HP PageWide Managed Color MFP P77940/P77950/P77960	Yes	Yes	Yes

**Table 6:** Single-function printers - Enterprise

Enterprise Single-Function Printers	FutureSmart 4	HP Accessibility Kit	HP Accessibility Assistant
HP Color LaserJet Enterprise M553x	Yes	No	Yes
HP Color LaserJet Enterprise M651	Yes	No	No
HP Color LaserJet Enterprise M652/653	Yes	No	Yes
HP Color LaserJet Enterprise M751	Yes	Yes	Yes
HP Color LaserJet Enterprise M855	Yes	No	No
HP LaserJet Enterprise M506x	Yes	No	Yes
HP LaserJet Enterprise M507x	Yes	Yes	Yes
HP LaserJet Enterprise M605x	Yes	No	Yes
HP LaserJet Enterprise M606x	Yes	No	Yes
HP LaserJet Enterprise M607/608/M609	Yes	No	Yes
HP LaserJet Enterprise M806	Yes	No	No
HP OfficeJet Enterprise Color X555	Yes	No	No
HP PageWide Enterprise Color 556	Yes	No	Yes
HP PageWide Enterprise Color 765	Yes	No	Yes

**Table 7:** Single-function printers - Managed

Managed Single-Function Printers	FutureSmart 4	HP Accessibility Kit	HP Accessibility Assistant
HP Color LaserJet Managed E55040	Yes	No	Yes
HP Color LaserJet Managed E65050/E65060	Yes	No	Yes
HP Color LaserJet Managed E65150/E65160	Yes	Yes	Yes
HP Color LaserJet Managed E75245	Yes	Yes	Yes
HP Color LaserJet Managed M553xm	Yes	No	Yes
HP Color LaserJet Managed M651 series	Yes	No	No
HP LaserJet Managed E50045	Yes	No	Yes
HP LaserJet Managed E50145	Yes	Yes	Yes
HP LaserJet Managed E60055/E60065/E60075	Yes	No	Yes
HP LaserJet Managed E60155/E60165/E60175	Yes	Yes	Yes
HP LaserJet Managed M506xm	Yes	No	Yes

**Table 7:** Single-function printers - Managed

Managed Single-Function Printers	FutureSmart 4	HP Accessibility Kit	HP Accessibility Assistant
HP PageWide Managed Color E55650	Yes	No	Yes
HP PageWide Managed Color E75160	Yes	No	Yes
HP PageWide Managed Color P75250	Yes	No	Yes

**Table 8:** Digital Senders/Scanners

Digital Senders/Scanners	FutureSmart 4	HP Accessibility Kit	HP Accessibility Assistant
HP Digital Sender Flow 8500 fn2 Document Capture Workstation	Yes	Yes	Yes
HP ScanJet Enterprise Flow N9120 Document Flatbed Scanner	Yes	Yes	Yes



More information  
<http://www8.hp.com/us/en/hp-information/accessibility-aging/index.html>

© Copyright 2018 HP, Inc. Development Company, L.P. The information contained herein is subject to change without notice. The only warranties for HP products and services are set forth in the express warranty statements accompanying such products and services. Nothing herein should be construed as constituting an additional warranty. HP shall not be liable for technical or editorial errors or omissions contained herein.

Reproduction, adaptation, or translation without prior written permission is prohibited, except as allowed under the copyright laws

4AA5-9080ENUS, September 2018

