

# EPSON

## WF-M5899 Series User's Guide



---

**Printing**

---

**Copying**

---

**Scanning**

---

**Faxing**

---

**Maintaining the Printer**

---

**Solving Problems**

---

## Contents

### **Guide to This Manual**

Introduction to the Manuals. . . . .	9
Important Safety Instructions (paper manual). . . . .	9
Start Here (paper manual). . . . .	9
User's Guide (digital manual). . . . .	9
Information on the Latest Manuals. . . . .	9
Searching for Information. . . . .	9
Printing Only the Pages You Need. . . . .	10
About This Manual. . . . .	10
Marks and Symbols. . . . .	10
Notes on Screenshots and Illustrations. . . . .	11
Operating System References. . . . .	11
Trademarks. . . . .	12
Copyright. . . . .	13

### **Important Instructions**

Safety Instructions. . . . .	16
Printer Advisories and Warnings. . . . .	17
Advisories and Warnings for Setting Up the Printer. . . . .	17
Advisories and Warnings for Using the Printer. . . . .	18
Advisories and Warnings for Using the Touchscreen. . . . .	18
Advisories and Warnings for Connecting to the Internet. . . . .	18
Advisories and Warnings for Using the Printer with a Wireless Connection. . . . .	18
Notes on the Administrator Password. . . . .	19
Advisories for Using Memory Devices. . . . .	20
Advisories and Warnings for Transporting or Storing the Printer. . . . .	20
Protecting Your Personal Information. . . . .	20

### **Part Names and Functions**

Front. . . . .	22
Inside. . . . .	24
Rear. . . . .	26

### **Guide to the Control Panel**

Control Panel. . . . .	28
Home Screen Configuration. . . . .	29
Guide to the Network Icon. . . . .	30
Menu Screen Configuration. . . . .	31
Job/Status Screen Configuration. . . . .	32

Reserve Job. . . . .	33
Guide to the Job Icon. . . . .	33
Entering Characters. . . . .	34

### **Preparing the Printer and Making Initial Settings**

Summary of Preparing the printer and Making Initial Settings. . . . .	36
Preparing the Printer. . . . .	36
Protecting the Printer from Unauthorized Setting Changes. . . . .	36
Configuring a Network Connection. . . . .	36
Summary of the Necessary Preparations for Each Feature. . . . .	37
Making Printer Settings. . . . .	37
Installing the Optional Paper Cassette Units. . . . .	38
Mounting an Authentication Device. . . . .	44
Connecting the Authentication Device. . . . .	44
Confirming the Connection Status of the Authentication Device. . . . .	44
Confirming the Authentication Card is Recognized. . . . .	45
Troubleshooting the Authentication Device. . . . .	45
Creating a Network Connection and Making Settings. . . . .	45
Changing the Administrator Password. . . . .	46
Protecting Settings Using Panel Lock. . . . .	47
Connecting the Printer to the Network. . . . .	48
Troubleshooting Network Connections. . . . .	54
Preparing and Setting Up the Printer According to Use. . . . .	63
Setting Available Optional Items. . . . .	63
Preparing to Send an E-mail. . . . .	65
Preparing a Shared Network Folder. . . . .	69
Contacts Registration. . . . .	87
Settings to use Your Cloud Service as Forwarding Fax Destinations. . . . .	97
Settings to Use Users Information on the LDAP Server as Destinations. . . . .	98
Sending Faxes Using a Fax Server. . . . .	102
Settings for Printing, Scanning, Copying and Faxing. . . . .	103
Initial Settings for Printing. . . . .	103
Preparing Scanning or Copying. . . . .	113
Making Fax Features Available. . . . .	115
Problems when Making Settings. . . . .	137

Hints to Solving Problems. . . . .	137
Cannot Access Web Config. . . . .	137

## **Loading Paper**

Paper Handling Precautions. . . . .	140
Paper Size and Type Settings. . . . .	140
List of Paper Type. . . . .	141
Loading Paper. . . . .	142
Loading Various Paper. . . . .	142
Loading Pre-punched Paper. . . . .	142
Loading Long Papers. . . . .	143

## **Placing Originals**

Placing Originals. . . . .	145
Originals that are not Supported by the ADF. . . . .	146

## **Inserting and Removing a Memory Device**

Inserting an External USB Device. . . . .	149
Removing an External USB Device. . . . .	149
Sharing Data on a Memory Device. . . . .	149

## **Printing**

Printing Documents. . . . .	152
Printing from a Computer - Windows. . . . .	152
Printing a Document Using the PostScript Printer Driver (Windows). . . . .	174
Printing from a Computer - Mac OS. . . . .	178
Printing from the PostScript Printer Driver on Mac OS. . . . .	185
Printing PDF Files from a Memory Device. . . . .	189
Printing Documents from Smart Devices. . . . .	189
Printing on Envelopes. . . . .	191
Printing on Envelopes from a Computer (Windows). . . . .	191
Printing on Envelopes from a Computer (Mac OS). . . . .	191
Printing Photos. . . . .	192
Printing JPEG Files from a Memory Device. . . . .	192
Printing TIFF Files from a Memory Device. . . . .	193
Printing Web Pages. . . . .	194
Printing Web Pages from Smart Devices. . . . .	194
Printing Using a Cloud Service. . . . .	195
Interrupting and Printing. . . . .	195

## **Copying**

Available Copying Methods. . . . .	198
Copying Originals. . . . .	198
Copying on 2-Sides. . . . .	198
Copying by Enlarging or Reducing. . . . .	199
Copying Multiple Originals onto One Sheet. . . . .	199
Copying in Page Order. . . . .	201
Copying Originals Using Good Quality. . . . .	201
Copying ID card. . . . .	202
Copying Envelopes. . . . .	202
Interrupting and Copying. . . . .	203
Basic Menu Options for Copying. . . . .	203
Density:. . . . .	203
Paper Setting:. . . . .	203
Reduce/Enlarge:. . . . .	203
Original Type:. . . . .	204
2-Sided:. . . . .	204
ID Card Copy:. . . . .	205
Advanced Menu Options for Copying. . . . .	205
Multi-Page:. . . . .	205
Original Size:. . . . .	205
Finishing:. . . . .	205
Orientation (Original). . . . .	205
Image Quality:. . . . .	206
Binding Margin:. . . . .	206
Reduce to Fit Paper:. . . . .	206
Remove Shadow:. . . . .	206
Remove Punch Holes:. . . . .	206

## **Scanning**

Available Scanning Methods. . . . .	208
Scanning Originals to a Network Folder. . . . .	208
Destination Menu Options for Scanning to a Network Folder. . . . .	209
Scanning Originals to an Email. . . . .	210
Recipient Menu Options for Scanning to an Email. . . . .	210
Scanning Originals to a Computer. . . . .	211
Scanning Originals to a Memory Device. . . . .	212
Scanning Originals to the Cloud. . . . .	212
Menu Options for Scanning. . . . .	213
Color Mode:. . . . .	213
File Format:. . . . .	213
Resolution:. . . . .	213
2-Sided:. . . . .	213
Scan Area:. . . . .	213
Original Type. . . . .	213
Orientation (Original):. . . . .	214

Density: . . . . .	214
Remove Shadow: . . . . .	214
Remove Punch Holes: . . . . .	214
Subject: . . . . .	214
Attached File Max Size: . . . . .	214
File Name: . . . . .	214
Scanning Using WSD. . . . .	214
Setting Up a WSD Port. . . . .	215
Scanning Originals to a Smart Device. . . . .	216

## **Faxing**

Before Using Fax Features. . . . .	218
Overview of this Printer's Fax Features. . . . .	218
Feature: Sending Faxes. . . . .	218
Feature: Receiving Faxes. . . . .	219
Feature: PC-FAX Send/Receive (Windows/Mac OS). . . . .	221
Features: Various Fax Reports. . . . .	222
Feature: Status or Logs for Fax Jobs. . . . .	222
Feature: Fax Box. . . . .	222
Feature: Security when Sending and Receiving Faxes. . . . .	223
Features: Other Useful Features. . . . .	224
Sending Faxes Using the Printer. . . . .	225
Selecting Recipients. . . . .	226
Various Ways of Sending Faxes. . . . .	226
Receiving Faxes on the Printer. . . . .	233
Receiving Incoming Faxes. . . . .	233
Receiving Faxes by Making a Phone Call. . . . .	235
Saving and Forwarding Received Faxes. . . . .	237
Viewing Received Faxes on the Printer's LCD Screen. . . . .	238
Menu Options for Faxing. . . . .	239
Recipient. . . . .	239
Fax Settings. . . . .	239
More. . . . .	242
Menu Options for Fax Box. . . . .	243
Inbox/Confidential. . . . .	243
Stored Documents: . . . . .	245
Polling Send/Board. . . . .	246
Checking the Status or Logs for Fax Jobs. . . . .	250
Displaying Information when Received Faxes are Unprocessed (Unread/Not Printed/Not Saved/Not Forwarded). . . . .	250
Checking Fax Jobs in Progress. . . . .	251
Checking the Fax Job History. . . . .	252
Reprinting Received Documents. . . . .	252
Sending a Fax from a Computer. . . . .	252

Sending Documents Created Using an Application (Windows). . . . .	253
Sending Documents Created Using an Application (Mac OS). . . . .	255
Receiving Faxes on a Computer. . . . .	257
Checking for New Faxes (Windows). . . . .	257
Checking for New Faxes (Mac OS). . . . .	259
Canceling the Feature that Saves Incoming Faxes to the Computer. . . . .	259

## **Maintaining the Printer**

Checking the Status of Consumables. . . . .	261
Improving Print, Copy, Scan, and Fax Quality. . . . .	262
Adjusting the Print Quality. . . . .	262
Checking and Cleaning the Print Head. . . . .	263
Preventing nozzle clogging. . . . .	264
Aligning the Print Head. . . . .	264
Cleaning the Paper Path for Ink Smears. . . . .	264
Cleaning the Scanner Glass. . . . .	265
Cleaning the ADF. . . . .	265
Cleaning the Translucent Film. . . . .	268
Cleaning the Printer. . . . .	270

## **In These Situations**

When the Software Disk is not Available. . . . .	272
When Replacing a Computer. . . . .	272
Installing or Uninstalling Applications Separately. . . . .	272
Installing the Applications Separately. . . . .	272
Installing a PostScript Printer Driver. . . . .	275
Adding a Genuine Epson Printer (for Mac OS Only). . . . .	276
Uninstalling Applications. . . . .	276
Making Settings for Connecting to the Computer. . . . .	278
Checking the Printer's Network Connection Status (Network Connection Report). . . . .	278
Connecting a Smart Device and Printer Directly (Wi-Fi Direct). . . . .	279
About Wi-Fi Direct. . . . .	279
Connecting to Devices using Wi-Fi Direct. . . . .	279
Disconnecting Wi-Fi Direct (Simple AP) Connection. . . . .	280
Changing the Wi-Fi Direct (Simple AP) Settings Such as the SSID. . . . .	281
Changing the Connection from Wi-Fi to USB. . . . .	282
Using a Printer with the Access Control Feature Enabled. . . . .	283
Logging on to the Printer from the Control Panel. . . . .	283



Registering a User Account on the Printer Driver (Windows).	284
Authenticating Users on Epson Scan 2 when Using Access Control.	284
Transporting and Storing the Printer.	285



## **Solving Problems**

Problem Solving.	290
Check the printer's error status.	290
Check the printer connection.	290
Check the printer settings.	291
Cannot Print, Copy, Scan, or Fax.	292
The Application or Printer Driver do not Work Properly.	292
The Printer Cannot Connect by USB.	295
Cannot Copy.	296
Cannot Send or Receive Faxes.	296
Paper Does Not Feed or Eject Correctly.	302
Printing, Copying, Scanning, and Faxing	
Quality is Poor.	305
Print Quality is Poor.	305
Copy Quality is Poor.	312
Scanned Image Problems.	318
The Quality of the Sent Fax is Poor.	320
Received Fax Quality is Poor.	322
A Message or Error Code is Displayed on the LCD Screen.	323
A Message is Displayed on the LCD Screen.	323
Error Code is Displayed on the Status Menu.	324
Paper Gets Jammed.	331
Preventing Paper Jams.	331
It is Time to Replace Ink Supply Units.	331
Ink Supply Unit Handling Precautions.	331
Replacing Ink Supply Units.	333
It is Time to Replace the Maintenance Box.	333
Maintenance Box Handling Precautions.	333
Replacing a Maintenance Box.	333
It is Time to Replace the Pickup Rollers.	334
Replacing Pickup Rollers for the Paper Cassette Unit.	334
Replacing Pickup Rollers for the Optional Paper Cassette Units.	334
Cannot Operate the Printer as Expected.	335
The Printer Does Not Turn On or Off.	335
Operations are Slow.	336
LCD Screen Gets Dark.	337
Touch Screen Does Not Respond.	337
Cannot Operate from the Control Panel.	338

"x" is Displayed on the Screen and you Cannot Select Photos.	338
Memory Device Is not Recognized.	338
Cannot Save Data to a Memory Device.	338
Operation Sounds Are Loud.	339
The Date and Time Are Incorrect.	339
The Root Certificate Needs to be Updated.	339
Cannot Perform Manual 2-sided Printing (Windows).	340
The Print Settings Menu is Not Displayed (Mac OS).	340
Forgot Your Password.	340
Copies are Made or Faxes are Sent Unintentionally.	340
Sender's Fax Number Not Displayed.	340
Sender's Fax Number Displayed on Received Faxes is Wrong.	341
Cannot Make Calls on the Connected Phone.	341
Answering Machine Cannot Answer Voice Calls	341
A Lot of Junk Faxes Have Been Received.	341
Cannot Solve Problem.	341
Cannot Solve Printing Problems.	342

## **Product Information**

Paper Information.	344
Available Paper and Capacities.	344
Consumable Products Information.	347
Ink Supply Unit Codes.	347
Maintenance Box Code.	348
Pickup Rollers Code.	348
Information on Optional Items.	349
Optional Paper Cassette Unit Code.	349
Software Information.	349
Application for Printing from a Computer (Windows Printer Driver).	349
Application for Printing from a Computer (Mac OS Printer Driver).	350
Application that can print PostScript Fonts (Windows PostScript Printer Driver).	351
Application that can print PostScript Fonts (Mac OS PostScript Printer Driver).	352
Application that can print PCL Language (PCL Printer Driver).	353
Application for Controlling the Scanner (Epson Scan 2).	353
Application for Configuring Fax Operations and Sending Faxes (FAX Utility).	354
Application for Sending Faxes (PC-FAX Driver)	355
Application for Configuring Printer Operations (Web Config).	355

Application for Updating Software and Firmware (Epson Software Updater) . . . . .	356
Software for Managing Devices on the Network (Epson Device Admin) . . . . .	357
Epson Authentication System (Epson Print Admin) . . . . .	357
Settings Menu List . . . . .	357
General Settings . . . . .	357
Print Counter . . . . .	389
Supply Status . . . . .	389
Maintenance . . . . .	390
Language  . . . . .	390
Printer Status/Print . . . . .	391
Contacts Manager . . . . .	391
User Settings  . . . . .	392
Authentication Device Status . . . . .	392
Epson Open Platform Information . . . . .	392
Product Specifications . . . . .	393
Printer Specifications . . . . .	393
Scanner Specifications . . . . .	393
ADF Specifications . . . . .	394
Fax Specifications . . . . .	394
Using Port for the Printer . . . . .	395
Interface Specifications . . . . .	397
Network Specifications . . . . .	397
PostScript Level 3 Compatibility . . . . .	400
Supported Third Party Services . . . . .	400
Memory Device Specifications . . . . .	401
Supported Data Specifications . . . . .	401
Dimensions . . . . .	401
Electrical Specifications . . . . .	402
Environmental Specifications . . . . .	403
Installation Location and Space . . . . .	403
System Requirements . . . . .	405
Font Specifications . . . . .	405
Available Fonts for PostScript . . . . .	405
Available Fonts for PCL (URW) . . . . .	406
List of Symbol Sets . . . . .	408
Regulatory Information . . . . .	411
Standards and Approvals . . . . .	411
German Blue Angel . . . . .	412
Restrictions on Copying . . . . .	413

## **Administrator Information**

Managing the Printer . . . . .	415
Checking Information for a Remote Printer . . . . .	415
Setting the Control Panel . . . . .	415
Controlling the Panel Operation . . . . .	416
Managing the Network Connection . . . . .	418

Configuring Email Notifications When Events Occur . . . . .	422
Power Saving Settings During Inactivity . . . . .	424
Setting the Sound . . . . .	425
Backing Up and Importing Printer Settings . . . . .	426
Updating the Firmware . . . . .	428
Synchronizing the Date and Time with Time Server . . . . .	430
Clearing Internal Memory Data . . . . .	430
Managing your Contacts . . . . .	431
Configuring Periodic Cleaning . . . . .	431
Controlling the Power Supply to the Printer Using Web Config . . . . .	432
Restore Default Settings . . . . .	432
Product Security Settings . . . . .	433
Restricting Available Features . . . . .	433
Restricting USB Connections and Use of External Memory . . . . .	436
Encrypting the Password . . . . .	437
Using the Audit Log Feature . . . . .	437
Restricting File Operations from PDL . . . . .	438
Changing the Administrator Password Using Web Config . . . . .	438
Enabling Program Verification on Start Up . . . . .	439
Configuring Domain Restrictions . . . . .	440
Network Security Settings . . . . .	440
Controlling Using Protocols . . . . .	440
Using a Digital Certificate . . . . .	445
SSL/TLS Communication with the Printer . . . . .	452
Encrypted Communication Using IPsec/IP Filtering . . . . .	454
Connecting the Printer to an IEEE802.1X Network . . . . .	466
Network Security Issues . . . . .	469
Using Epson Open Platform . . . . .	475
Epson Open Platform Overview . . . . .	475
Configuring Epson Open Platform . . . . .	476
Validating of Epson Open Platform . . . . .	476
Epson Remote Services Information . . . . .	477

## **Where to Get Help**

Technical Support Web Site . . . . .	479
Contacting Epson Support . . . . .	479
Before Contacting Epson . . . . .	479
Help for Users in Europe . . . . .	479
Help for Users in Taiwan . . . . .	480
Help for Users in Australia . . . . .	480
Help for Users in New Zealand . . . . .	481
Help for Users in Singapore . . . . .	481
Help for Users in Thailand . . . . .	481

---

Help for Users in Vietnam. . . . .	482
Help for Users in Indonesia. . . . .	482
Help for Users in Hong Kong. . . . .	483
Help for Users in Malaysia. . . . .	483
Help for Users in India. . . . .	483
Help for Users in the Philippines. . . . .	484

---

# Guide to This Manual

Introduction to the Manuals. . . . .	9
Searching for Information. . . . .	9
Printing Only the Pages You Need. . . . .	10
About This Manual. . . . .	10
Trademarks. . . . .	12
Copyright. . . . .	13

## Introduction to the Manuals

The following manuals are supplied with your Epson printer. As well as the manuals, check the various types of help information available from the printer itself or from the Epson software applications.

### Important Safety Instructions (paper manual)

Provides you with instructions to ensure the safe use of this printer.

### Start Here (paper manual)

Provides you with information on setting up the printer and installing the software.

### User's Guide (digital manual)

This manual. Available as a PDF and Web manual. Provides detailed information and instructions on using the printer and solving problems.

### Information on the Latest Manuals

#### Paper manual

Visit the Epson Europe support website at <http://www.epson.eu/support>, or the Epson worldwide support website at <http://support.epson.net/>.

#### Digital manual

Visit the following website, enter the product name, and then go to **Support**.

<https://epson.sn>

## Searching for Information

The PDF manual allows you to search for information you are looking for by keyword, or jump directly to specific sections using the bookmarks. This section explains how to use a PDF manual that has been opened in Adobe Acrobat Reader DC on your computer.

### Searching by keyword

Click **Edit > Advanced Search**. Enter the keyword (text) for information you want to find in the search window, and then click **Search**. Hits are displayed as a list. Click one of the displayed hits to jump to that page.

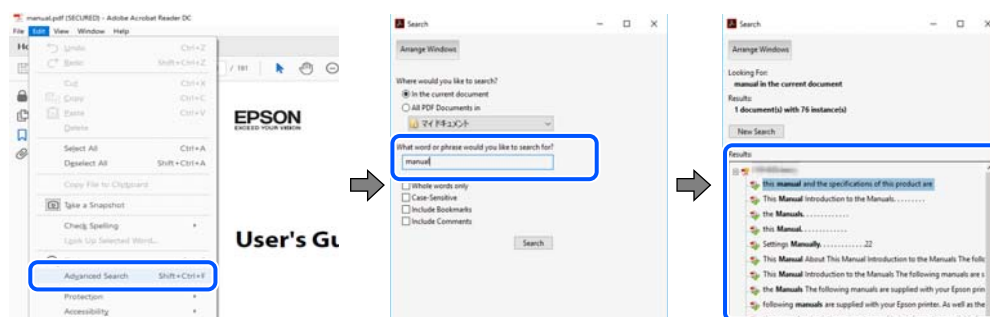

### Jumping directly from bookmarks

Click a title to jump to that page. Click + or > to view the lower level titles in that section. To return to the previous page, perform the following operation on your keyboard.

- ❑ Windows: Hold down **Alt**, and then press ←.
- ❑ Mac OS: Hold down the command key, and then press ←.

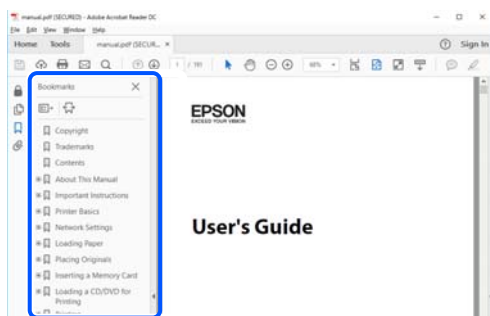

---

## Printing Only the Pages You Need

You can extract and print only the pages you need. Click **Print** in the **File** menu, and then specify the pages you want to print in **Pages in Pages to Print**.

- ❑ To specify a series of pages, enter a hyphen between the start page and the end page.  
Example: 20-25
- ❑ To specify pages that are not in series, divide the pages with commas.  
Example: 5, 10, 15

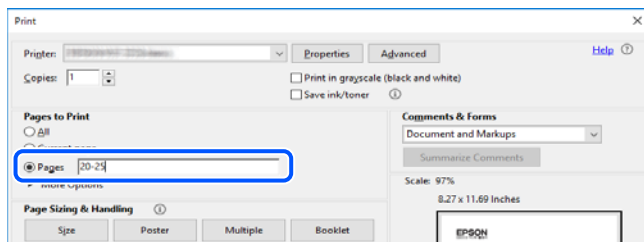

---

## About This Manual

This section explains the meaning of marks and symbols, notes on descriptions, and operating system reference information used in this manual.

### Marks and Symbols



**Caution:**

*Instructions that must be followed carefully to avoid bodily injury.*



**Important:**

*Instructions that must be observed to avoid damage to your equipment.*

**Note:**

*Provides complementary and reference information.*

**Related Information**

➔ Links to related sections.

 Provides Web Movie Manuals of the operating instructions. See the related information link.

 Control panel menu items that are restricted when the administrator lock is enabled.

## Notes on Screenshots and Illustrations

- Screenshots of the printer driver are from Windows 10 or macOS High Sierra (10.13). The content displayed on the screens varies depending on the model and situation.
- Illustrations used in this manual are examples only. Although there may be slight differences depending on the model, the method of operation is the same.
- Some of the menu items on the LCD screen vary depending on the model and settings.
- You can read the QR code using dedicated app.

## Operating System References

### Windows

In this manual, terms such as "Windows 11", "Windows 10", "Windows 8.1", "Windows 8", "Windows 7", "Windows Vista", "Windows XP", "Windows Server 2022", "Windows Server 2019", "Windows Server 2016", "Windows Server 2012 R2", "Windows Server 2012", "Windows Server 2008 R2", "Windows Server 2008", "Windows Server 2003 R2", and "Windows Server 2003" refer to the following operating systems. Additionally, "Windows" is used to refer to all versions.

- Microsoft® Windows® 11 operating system
- Microsoft® Windows® 10 operating system
- Microsoft® Windows® 8.1 operating system
- Microsoft® Windows® 8 operating system
- Microsoft® Windows® 7 operating system
- Microsoft® Windows Vista® operating system
- Microsoft® Windows® XP operating system
- Microsoft® Windows® XP Professional x64 Edition operating system
- Microsoft® Windows Server® 2022 operating system
- Microsoft® Windows Server® 2019 operating system
- Microsoft® Windows Server® 2016 operating system
- Microsoft® Windows Server® 2012 R2 operating system
- Microsoft® Windows Server® 2012 operating system
- Microsoft® Windows Server® 2008 R2 operating system

- ❑ Microsoft® Windows Server® 2008 operating system
- ❑ Microsoft® Windows Server® 2003 R2 operating system
- ❑ Microsoft® Windows Server® 2003 operating system

## Mac OS

In this manual, "Mac OS" is used to refer to Mac OS X 10.9.5 or later as well as macOS 11 or later.

---

## Trademarks

- ❑ Microsoft®, Windows®, Windows Server®, and Windows Vista® are registered trademarks of Microsoft Corporation.
- ❑ Apple, Mac, macOS, OS X, Bonjour, ColorSync, Safari, AirPrint, iPad, iPhone, iPod touch, TrueType, and iBeacon are trademarks of Apple Inc., registered in the U.S. and other countries.
- ❑ Use of the Works with Apple badge means that an accessory has been designed to work specifically with the technology identified in the badge and has been certified by the developer to meet Apple performance standards.
- ❑ Chrome, Chrome OS, Google Play and Android are trademarks of Google LLC.
- ❑ Albertus, Arial, Coronet, Gill Sans, Joanna and Times New Roman are trademarks of The Monotype Corporation registered in the United States Patent and Trademark Office and may be registered in certain jurisdictions.
- ❑ ITC Avant Garde Gothic, ITC Bookman, Lubalin Graph, Mona Lisa, ITC Symbol, Zapf Chancery and Zapf Dingbats are trademarks of International Typeface Corporation registered in the U.S. Patent and Trademark Office and may be registered in certain other jurisdictions.
- ❑ Clarendon, Eurostile and New Century Schoolbook are trademarks of Linotype GmbH registered in the U.S. Patent and Trademark Office and may be registered in certain other jurisdictions.
- ❑ Wingdings is a registered trademark of Microsoft Corporation in the United States and other countries.
- ❑ CG Omega, CG Times, Garamond Antiqua, Garamond Halbfett, Garamond Kursiv, Garamond Halbfett Kursiv are trademarks of Monotype Imaging, Inc. and may be registered in certain jurisdictions.
- ❑ Antique Olive is a trademark of M. Olive.
- ❑ Marigold and Oxford are trademarks of AlphaOmega Typography.
- ❑ Helvetica, Optima, Palatino, Times and Univers are trademarks of Linotype Corp. registered in the U.S. Patent and Trademark Office and may be registered in certain other jurisdictions in the name of Linotype Corp. or its licensee Linotype GmbH.
- ❑ ITC Avant Garde Gothic, Bookman, Zapf Chancery and Zapf Dingbats are trademarks of International Typeface Corporation registered in the United States Patent and Trademark Office and may be registered in certain jurisdictions.
- ❑ PCL is the registered trademark of Hewlett-Packard Company.
- ❑ Adobe, Acrobat, Photoshop, PostScript®3™, and Reader are either registered trademarks or trademarks of Adobe in the United States and/or other countries.



Arcfour

This code illustrates a sample implementation of the Arcfour algorithm.

Copyright © April 29, 1997 Kalle Kaukonen. All Rights Reserved.

Redistribution and use in source and binary forms, with or without modification, are permitted provided that this copyright notice and disclaimer are retained.

THIS SOFTWARE IS PROVIDED BY KALLE KAUKONEN AND CONTRIBUTORS "AS IS" AND ANY EXPRESS OR IMPLIED WARRANTIES, INCLUDING, BUT NOT LIMITED TO, THE IMPLIED WARRANTIES OF MERCHANTABILITY AND FITNESS FOR A PARTICULAR PURPOSE ARE DISCLAIMED. IN NO EVENT SHALL KALLE KAUKONEN OR CONTRIBUTORS BE LIABLE FOR ANY DIRECT, INDIRECT, INCIDENTAL, SPECIAL, EXEMPLARY, OR CONSEQUENTIAL DAMAGES (INCLUDING, BUT NOT LIMITED TO, PROCUREMENT OF SUBSTITUTE GOODS OR SERVICES; LOSS OF USE, DATA, OR PROFITS; OR BUSINESS INTERRUPTION) HOWEVER CAUSED AND ON ANY THEORY OF LIABILITY, WHETHER IN CONTRACT, STRICT LIABILITY, OR TORT (INCLUDING NEGLIGENCE OR OTHERWISE) ARISING IN ANY WAY OUT OF THE USE OF THIS SOFTWARE, EVEN IF ADVISED OF THE POSSIBILITY OF SUCH DAMAGE.

QR Code is a registered trademark of DENSO WAVE INCORPORATED in Japan and other countries.

Firefox is a trademark of the Mozilla Foundation in the U.S. and other countries.

Mopria® and the Mopria® Logo are registered and/or unregistered trademarks and service marks of Mopria Alliance, Inc. in the United States and other countries. Unauthorized use is strictly prohibited.

microSDHC Logo is a trademark of SD-3C, LLC.

Note: microSDHC is built into the product and cannot be removed.



General Notice: Other product names used herein are for identification purposes only and may be trademarks of their respective owners. Epson disclaims any and all rights in those marks.

---

## Copyright

No part of this publication may be reproduced, stored in a retrieval system, or transmitted in any form or by any means, electronic, mechanical, photocopying, recording, or otherwise, without the prior written permission of Seiko Epson Corporation. No patent liability is assumed with respect to the use of the information contained herein. Neither is any liability assumed for damages resulting from the use of the information herein. The information contained herein is designed only for use with this Epson product. Epson is not responsible for any use of this information as applied to other products.

Neither Seiko Epson Corporation nor its affiliates shall be liable to the purchaser of this product or third parties for damages, losses, costs, or expenses incurred by the purchaser or third parties as a result of accident, misuse, or abuse of this product or unauthorized modifications, repairs, or alterations to this product, or (excluding the U.S.) failure to strictly comply with Seiko Epson Corporation's operating and maintenance instructions.

Seiko Epson Corporation and its affiliates shall not be liable for any damages or problems arising from the use of any options or any consumable products other than those designated as Original Epson Products or Epson Approved Products by Seiko Epson Corporation.

Seiko Epson Corporation shall not be held liable for any damage resulting from electromagnetic interference that occurs from the use of any interface cables other than those designated as Epson Approved Products by Seiko Epson Corporation.

© 2023 Seiko Epson Corporation

The contents of this manual and the specifications of this product are subject to change without notice.

---

# Important Instructions

Safety Instructions. . . . .	16
Printer Advisories and Warnings. . . . .	17
Protecting Your Personal Information. . . . .	20

## Safety Instructions

Read and follow these instructions to ensure safe use of this printer. Make sure you keep this manual for future reference. Also, be sure to follow all warnings and instructions marked on the printer.

- Some of the symbols used on your printer are to ensure safety and proper use of the printer. Visit the following Web site to learn the meaning of the symbols.  
<http://support.epson.net/symbols/>
- Use only the power cord supplied with the printer and do not use the cord with any other equipment. Use of other cords with this printer or the use of the supplied power cord with other equipment may result in fire or electric shock.
- Be sure your AC power cord meets the relevant local safety standard.
- Never disassemble, modify, or attempt to repair the power cord, plug, printer unit, scanner unit, or options by yourself, except as specifically explained in the printer's manuals.
- Unplug the printer and refer servicing to qualified service personnel under the following conditions:  
The power cord or plug is damaged; liquid has entered the printer; the printer has been dropped or the casing damaged; the printer does not operate normally or exhibits a distinct change in performance. Do not adjust controls that are not covered by the operating instructions.
- Place the printer near a wall outlet where the plug can be easily unplugged.
- Do not place or store the printer outdoors, near excessive dirt or dust, water, heat sources, or in locations subject to shocks, vibrations, high temperature or humidity.
- Take care not to spill liquid on the printer and not to handle the printer with wet hands.
- Keep the printer at least 22 cm away from cardiac pacemakers. Radio waves from this printer may adversely affect the operation of cardiac pacemakers.
- If the LCD screen is damaged, contact your dealer. If the liquid crystal solution gets on your hands, wash them thoroughly with soap and water. If the liquid crystal solution gets into your eyes, flush them immediately with water. If discomfort or vision problems remain after a thorough flushing, see a doctor immediately.
- Avoid using a telephone during an electrical storm. There may be a remote risk of electric shock from lightning.
- Do not use a telephone to report a gas leak in the vicinity of the leak.
- The printer is heavy and should not be lifted or carried by less than two people. If any paper cassettes other than Paper Cassette 1 are installed, uninstall them before lifting the printer. When lifting the printer, two or more people should assume the correct positions as shown below.

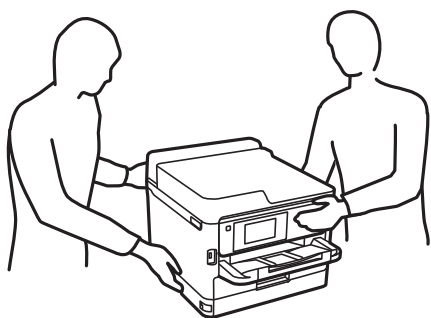

- Be careful when you handle used ink supply units, as there may be some ink around the ink supply port.
  - If ink gets on your skin, wash the area thoroughly with soap and water.
  - If ink gets into your eyes, flush them immediately with water. If discomfort or vision problems continue after a thorough flushing, see a doctor immediately.
  - If ink gets into your mouth, see a doctor right away.
- Do not disassemble the ink supply unit and the maintenance box; otherwise ink may get into your eyes or on your skin.
- Do not shake ink supply units too vigorously; otherwise ink may leak from the ink supply units.
- Keep ink supply units and maintenance box out of the reach of children.

---



## Printer Advisories and Warnings

Read and follow these instructions to avoid damaging the printer or your property. Make sure you keep this manual for future reference.

### Advisories and Warnings for Setting Up the Printer

- Do not block or cover the vents and openings in the printer.
- Use only the type of power source indicated on the printer's label.
- Avoid using outlets on the same circuit as photocopiers or air control systems that regularly switch on and off.
- Avoid electrical outlets controlled by wall switches or automatic timers.
- Keep the entire computer system away from potential sources of electromagnetic interference, such as loudspeakers or the base units of cordless telephones.
- The power-supply cords should be placed to avoid abrasions, cuts, fraying, crimping, and kinking. Do not place objects on top of the power-supply cords and do not allow the power-supply cords to be stepped on or run over. Be particularly careful to keep all the power-supply cords straight at the ends.
- If you use an extension cord with the printer, make sure that the total ampere rating of the devices plugged into the extension cord does not exceed the cord's ampere rating. Also, make sure that the total ampere rating of all devices plugged into the wall outlet does not exceed the wall outlet's ampere rating.
- If you plan to use the printer in Germany, the building installation must be protected by a 10 or 16 amp circuit breaker to provide adequate short-circuit protection and over-current protection for the printer.
- When connecting the printer to a computer or other device with a cable, ensure the correct orientation of the connectors. Each connector has only one correct orientation. Inserting a connector in the wrong orientation may damage both devices connected by the cable.
- Place the printer on a flat, stable surface that extends beyond the base of the printer in all directions. The printer will not operate properly if it is tilted at an angle.
- Allow space above the printer so that you can fully raise the document cover.
- Leave enough space in front of the printer for the paper to be fully ejected.
- Avoid places subject to rapid changes in temperature and humidity. Also, keep the printer away from direct sunlight, strong light, or heat sources.

## Advisories and Warnings for Using the Printer

- Do not insert objects through the slots in the printer.
- Do not put your hand inside the printer during printing.
- Do not touch the white flat cable inside the printer.
- Do not use aerosol products that contain flammable gases inside or around the printer. Doing so may cause fire.
- Do not move the print head by hand; otherwise, you may damage the printer.
- Be careful not to trap your fingers when closing the scanner unit.
- Do not press too hard on the scanner glass when placing the originals.
- Always turn the printer off using the  button. Do not unplug the printer or turn off the power at the outlet until the  light stops flashing.
- If you are not going to use the printer for a long period, be sure to unplug the power cord from the electrical outlet.

## Advisories and Warnings for Using the Touchscreen

- The LCD screen may contain a few small bright or dark spots, and because of its features it may have an uneven brightness. These are normal and do not indicate that it is damaged in any way.
- Only use a dry, soft cloth for cleaning. Do not use liquid or chemical cleaners.
- The exterior cover of the touchscreen could break if it receives a heavy impact. Contact your dealer if the panel surface chips or cracks, and do not touch or attempt to remove the broken pieces.
- Press the touchscreen gently with your finger. Do not press force or operate with your nails.
- Do not use sharp objects such as ball point pens or sharp pencils to perform operations.
- Condensation inside the touchscreen due to abrupt changes in temperature or humidity may cause performance to deteriorate.

## Advisories and Warnings for Connecting to the Internet

Do not connect this product to the Internet directly. Connect it in a network protected by a router or firewall.

## Advisories and Warnings for Using the Printer with a Wireless Connection

- Radio waves from this printer may negatively affect the operation of medical electronic equipment, causing them to malfunction. When using this printer inside medical facilities or near medical equipment, follow directions from the authorized personnel representing the medical facilities, and follow all posted warnings and directions on the medical equipment.
- Radio waves from this printer may negatively affect the operation of automatically controlled devices such as automatic doors or fire alarms, and could lead to accidents due to malfunction. When using this printer near automatically controlled devices, follow all posted warnings and directions on these devices.

## Notes on the Administrator Password

This printer allows you to set an administrator password to prevent unauthorized access or changes to the device settings and network settings stored in the product when connecting to a network.

### Default Value of the Administrator Password

The default value of the administrator password is printed on the label on the product itself, such as the one shown. The position where the label is attached depends on the product, such as the side where the cover is opened, the back, or the bottom.

The following illustration is an example of the label attachment position on the side of the printer where the cover opens.

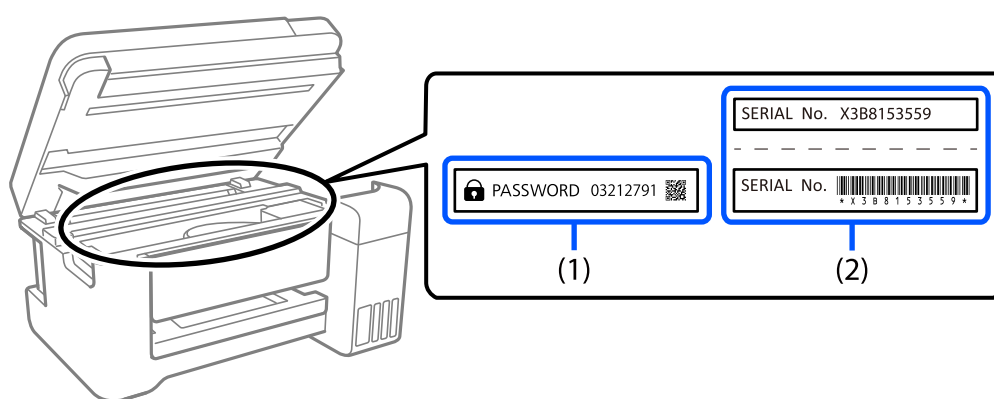

If both labels (1) and (2) are attached, the value next to PASSWORD written on the label in (1) is the default value. In this example, the default value is 03212791.

If only label (2) is attached, the serial number printed on the label in (2) is the default value. In this example, the default value is X3B8153559.

## Changing the Administrator Password

It can be changed from the printer control panel and Web Config. When changing the password, set it with at least 8 single-byte alphanumeric characters and symbols.

### Related Information

- ➔ [“Changing the Administrator Password from the Control Panel” on page 46](#)
- ➔ [“Changing the Administrator Password from the Computer” on page 46](#)

## Operations that Require You to Enter the Administrator Password

If you are prompted to enter the administrator password when performing the following operations, enter the administrator password set on the printer.

- When updating the firmware of the printer from a computer or smart device
- When logging on to the advanced settings of Web Config
- When setting using an application, such as Fax Utility, that can change the printer's settings.

- When selecting a menu on the printer's control panel that has been locked by your administrator.

#### **Related Information**

- ➔ [“Target Items for Lock Setting” on page 416](#)

## **Initializing the Administrator Password**

You can return the administrator password to the default settings from the administrator settings menu. If you have forgotten your password and cannot return to the default settings, you need to contact Epson Support to request service.

#### **Related Information**

- ➔ [“Changing the Administrator Password from the Control Panel” on page 46](#)
- ➔ [“Changing the Administrator Password from the Computer” on page 46](#)
- ➔ [“Where to Get Help” on page 478](#)

## **Advisories for Using Memory Devices**

When you connect a memory device to the printer, any device that is on the same network as the printer might be able to access the data on the memory device.

To prevent access, you need to disable the the following setting on Web Config.

**Network** tab > **MS Network** > **File Sharing**

## **Advisories and Warnings for Transporting or Storing the Printer**

- When storing or transporting the printer, avoid tilting it, placing it vertically, or turning it upside down; otherwise ink may leak.
- Before transporting the printer, make sure that the print head is in the home (far right) position, and the ink supply unit is installed.

---

## **Protecting Your Personal Information**

When you give the printer to someone else or dispose of it, erase all the personal information stored in the printer's memory by selecting **Settings > General Settings > System Administration > Restore Default Settings > Clear All Data and Settings** on the control panel. Also, make sure you delete the printer's internal memory data by selecting **Settings > General Settings > System Administration > Clear Internal Memory Data > PDL Font, Macro, and Working Area** on the control panel.



---

# Part Names and Functions

Front. ....	22
Inside. ....	24
Rear. ....	26

## Front

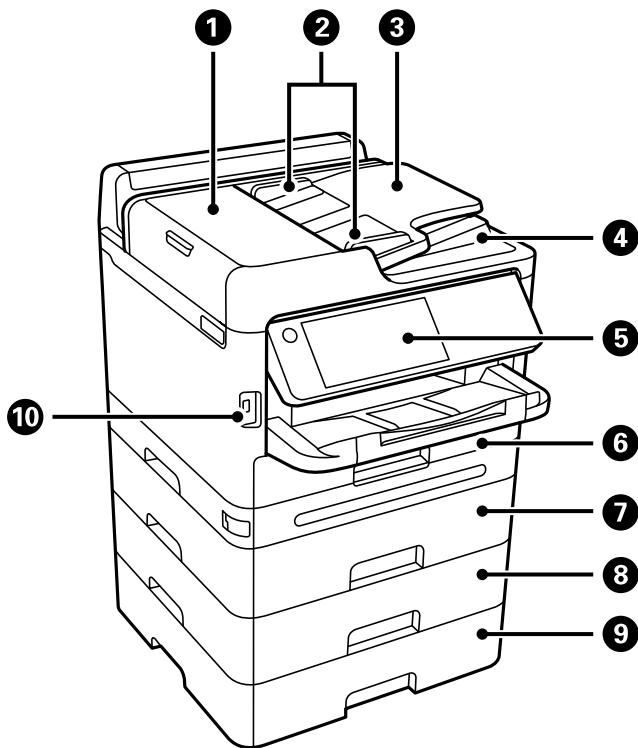

①	ADF (Automatic Document Feeder) cover (F)	Open when removing jammed originals in the ADF.
②	ADF edge guides	Feeds originals straight into the printer. Slide to the edges of the originals.
③	ADF input tray	Feeds originals automatically.
④	ADF output tray	Holds originals ejected from the ADF.
⑤	Control panel	Allows you to make settings and perform operations on the printer. Also displays the printer's status.
⑥	Paper cassette 1 or Paper cassette (C1)	Loads paper.
⑦	Paper cassette 2 (C2)	Optional paper cassette unit. Loads paper. You can install up to 3 paper cassette units.
⑧	Paper cassette 3 (C3)	
⑨	Paper cassette 4 (C4)	
⑩	External interface USB port	Connects memory devices.

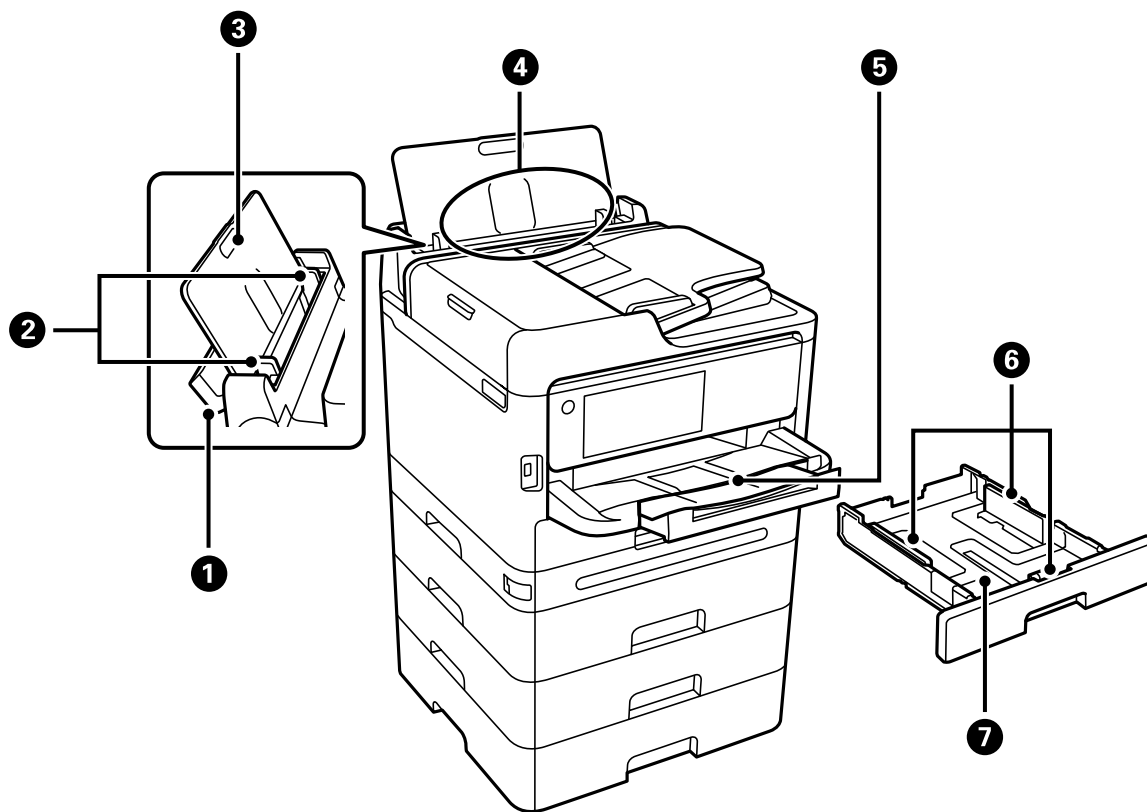

①	Paper tray cover	Prevents foreign substance from entering the printer. Usually keep this cover closed.
②	Edge guides	Feeds the paper straight into the printer. Slide to the edges of the paper.
③	Paper support	Supports loaded paper.
④	Paper tray (B)	Loads paper.
⑤	Output tray	Holds the ejected paper. Slide out the tray by hand and push it back in to store it.
⑥	Edge guides	Feeds the paper straight into the printer. Slide to the edges of the paper.
⑦	Paper cassette	Loads paper.

## Inside

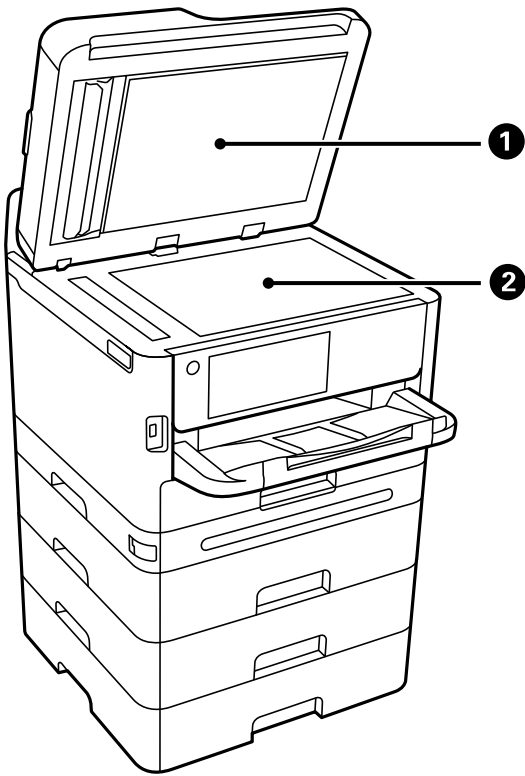

1	Document cover	Blocks external light while scanning.
2	Scanner glass	Place the originals. You can place originals that are not fed from the ADF such as envelopes or thick books.

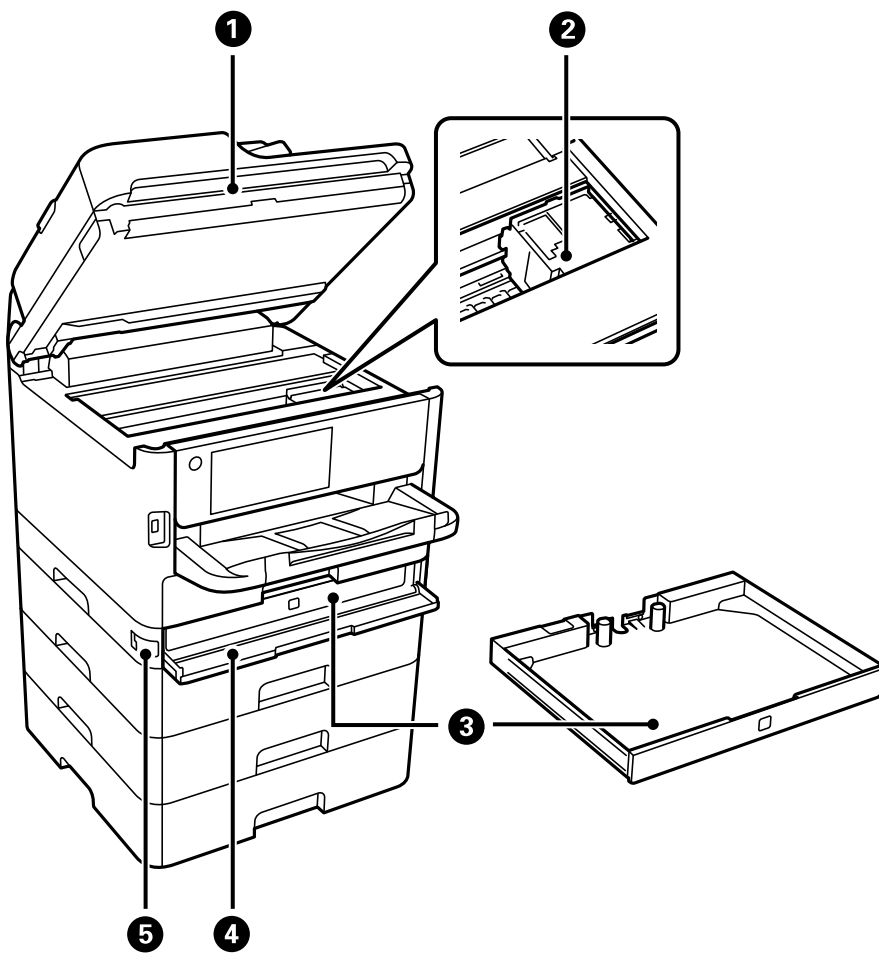

①	Scanner unit (J)	Scans placed originals. Open to remove jammed paper. This unit should usually be kept closed.
②	Print head	Fires ink.
③	Ink tray	Sets an ink supply unit.
④	Ink cover (A)	Open when replacing ink supply units.
⑤	Cover lock	Locks the ink cover.

## Rear

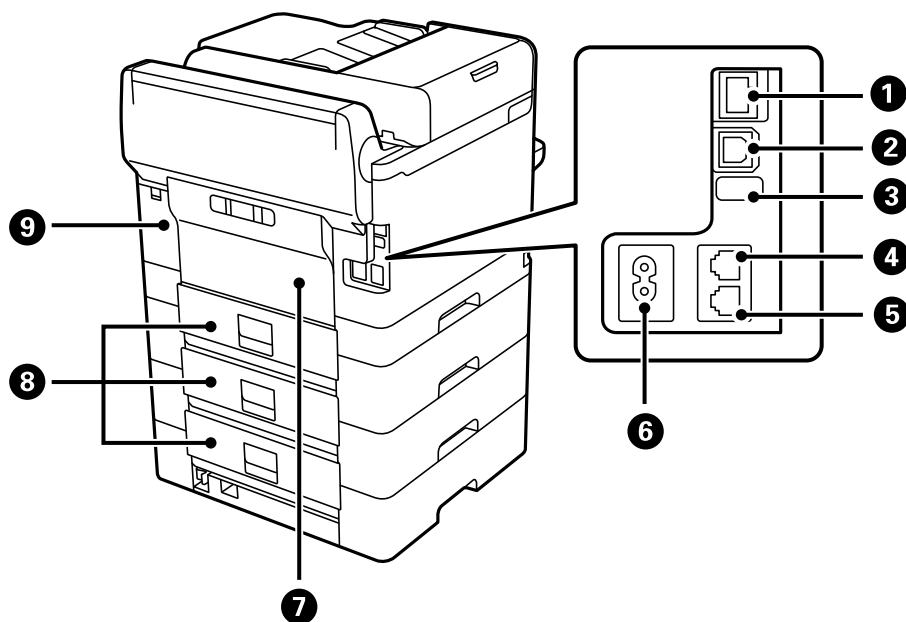

①	LAN port	Connects a LAN cable.
②	USB port	Connects a USB cable to connect with a computer.
③	Service USB port	USB port for future use. Do not remove the sticker.
④	LINE port	Connects a phone line.
⑤	EXT. port	Connects external phone devices.
⑥	AC inlet	Connects the power cord.
⑦	Rear cover (D)	Open when replacing the pickup roller or removing jammed paper.
⑧	Rear cover (E)	Open when replacing the pickup roller or removing jammed paper.
⑨	Maintenance box cover (H)	Open when replacing the maintenance box. The maintenance box is a container that collects a very small amount of surplus ink during cleaning or printing.

---

# Guide to the Control Panel

Control Panel. . . . .	28
Home Screen Configuration. . . . .	29
Menu Screen Configuration. . . . .	31
Job/Status Screen Configuration. . . . .	32
Entering Characters. . . . .	34

# Control Panel

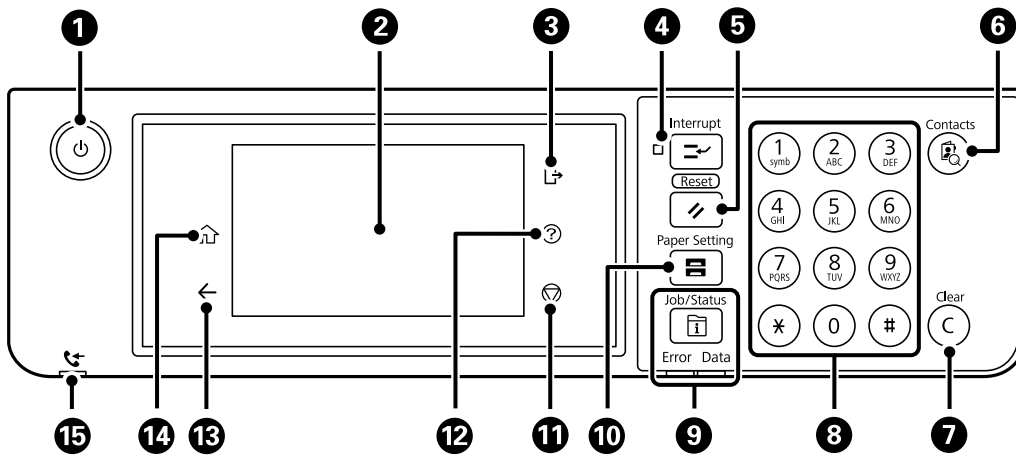









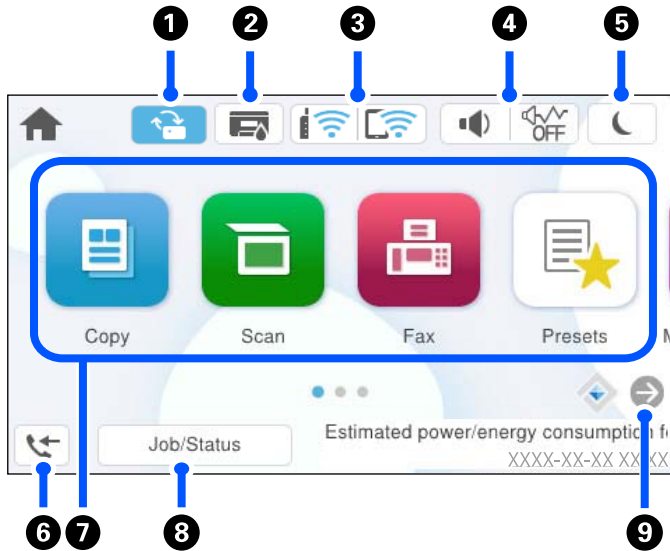

1	<p>Turns the printer on or off.</p> <p>Unplug the power cord after checking that the power light is off.</p>
2	<p>Displays setting items and messages.</p> <p>When no operations are performed for a specific length of time, the printer enters sleep mode and the display turns off. Tap anywhere on the touch screen to turn on the display. Depending on the current settings, pressing the buttons on the control panel wakes the printer from sleep mode.</p>
3	<p>Logs off from the printer when <b>Access Control</b> is enabled.</p> <p>When <b>Access Control</b> is disabled, this is also disabled.</p>
4	<p>Pauses the current print job and allows you to interrupt other jobs that the printer has already received, interrupt copying operations, and so on. However, you cannot interrupt a new job from the computer.</p> <p>Press this button again to restart a paused job.</p>
5	<p>Resets the current settings to user default settings. If user default settings have not been made, resets to the factory default.</p>
6	<p>Displays the <b>Contacts</b> list. You can register, edit or delete the contacts.</p>
7	<p>Clears number settings such as the number of copies.</p>
8	<p>Enters numbers, characters, and symbols.</p>
9	<p>Displays the <b>Job/Status</b> menu. You can check the printer's status and job history.</p> <p>The error light on the left flashes or turns on when an error occurs.</p> <p>The data light on the right flashes when the printer is processing data. It turns on when there are queued jobs.</p>
10	<p>Displays the <b>Paper Setting</b> screen. You can select the paper size and paper type settings for each paper source.</p>
11	<p>Stops the current operation.</p>
12	<p>Displays the <b>Help</b> screen.</p> <p>You can check solutions to problems from here.</p>
13	<p>Returns to the previous screen.</p>
14	<p>Displays the home screen.</p>



15	Turns on when received documents that have not yet been read, printed, or saved, are stored in the printer's memory.
----	--







## Home Screen Configuration



1		<p>This is displayed when a firmware update is available.</p> <p>Tap it to update the firmware to improve the printer's features. We recommend using the printer with the latest version of the firmware.</p>
2		<p>Displays the Printer Status screen.</p> <p>You can check the approximate ink levels and the approximate service life of the maintenance box.</p>
3		<p>Displays the network connection status. See the following for more details.</p> <p><a href="#">"Guide to the Network Icon" on page 30</a></p>
4		<p>Displays the Device Sound Settings screen.</p> <p>You can set Mute and Quiet Mode. You can also access the Sounds menu from this screen. You can also make this setting from the <b>Settings</b> menu.</p> <p><b>Settings &gt; General Settings &gt; Basic Settings &gt; Sounds</b></p>
		<p>Indicates whether or not Quiet Mode is set for the printer. When this feature is enabled, the noise made by printer operations is reduced, but print speed may slow down. However, noises may not be reduced depending on the selected paper type and print quality.</p>
		
		<p>Indicates that Mute is set for the printer.</p>
5		<p>Select the icon to enter sleep mode. When the icon is grayed out, the printer cannot enter sleep mode.</p>
6		<p>Displays the Fax Data Information screen. The number displayed indicates the number of faxes that have not yet been read, printed, or saved.</p>





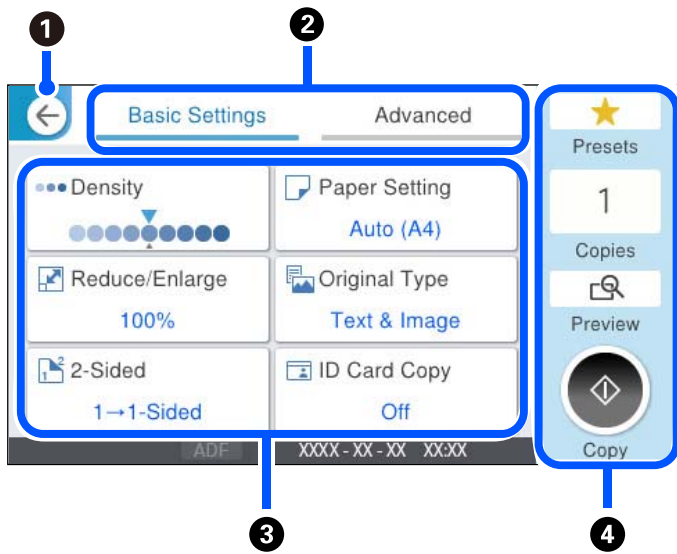

7	<p>Displays each menu.</p> <ul style="list-style-type: none"> <li><input type="checkbox"/> Copy Allows you to copy documents.</li> <li><input type="checkbox"/> Scan Allows you to scan documents and save them to a memory device or a computer.</li> <li><input type="checkbox"/> Fax Allows you to send faxes.</li> <li><input type="checkbox"/> Presets Allows you to register frequently used settings for copying, scanning, or faxing as a preset.</li> <li><input type="checkbox"/> Memory Device Allows you to print JPEG, TIFF or PDF data on a memory device such as a USB flash drive connected to the printer.</li> <li><input type="checkbox"/> Fax Box Allows you to store received documents, documents to be sent, or documents for polling faxes.</li> <li><input type="checkbox"/> Print From Internal Memory Allows you to temporarily save jobs sent from the printer driver to the printer's memory before printing. You can print a password protected job and test prints when printing multiple copies.</li> <li><input type="checkbox"/> Maintenance Displays the menus recommended to improve the quality of your printouts such as unclogging nozzles by printing a nozzle check pattern and performing head cleaning, and improving blurring or banding in your printouts by aligning the print head. You can also make this setting from the <b>Settings</b> menu. <b>Settings &gt; Maintenance</b></li> <li><input type="checkbox"/> Settings Allows you to make settings related to maintenance, printer settings, and operations.</li> </ul>	
8	Job/Status	Displays on-going jobs that are standing by. Tap to display the type of jobs, arrival timer, user names, and so on as a list. The number displayed indicates the number of jobs that are standing by.
9		Scrolls the screen to the right.

## Guide to the Network Icon

	The printer is not connected to a wired (Ethernet) network or a wireless (Wi-Fi) network.
	The printer is connected to a wired (Ethernet) network.
	The printer is searching for SSID, unset IP address, or having a problem with a wireless (Wi-Fi) network.
	The printer is connected to a wireless (Wi-Fi) network. The number of bars indicates the signal strength of the connection. The more bars there are, the stronger the connection.
	The printer is not connected to a wireless (Wi-Fi) network in Wi-Fi Direct (Simple AP) mode.
	The printer is connected to a wireless (Wi-Fi) network in Wi-Fi Direct (Simple AP) mode.

# Menu Screen Configuration



①	Returns to the previous screen.								
②	Switches the list of settings using the tabs. The <b>Basic Settings</b> tab displays frequently used items. The <b>Advanced</b> tab displays other items that you can set as necessary.								
③	<p>Displays the list of setting items. When  is displayed, you can view additional information by selecting the icon. Make settings by selecting the item or adding a check mark. When you have changed an item from the user default or the factory default,  is displayed on the item.</p> <p> is displayed when the setting is environmentally friendly.</p> <p>Grayed out items are not available. Select the item to check why it is unavailable.</p> <p>If any problems occur,  is displayed on the item. Select the icon to check how to solve the problem.</p>								
④	<p>Starts operations using the current settings. Items vary depending on the menu.</p> <table border="1" data-bbox="239 1478 1436 1702"> <tr> <td data-bbox="239 1478 438 1534">Presets</td> <td data-bbox="438 1478 1436 1534">Displays the preset list. You can register current setting as a preset, or load registered presets.</td> </tr> <tr> <td data-bbox="239 1534 438 1590">Copies</td> <td data-bbox="438 1534 1436 1590">Displays the on-screen keypad allowing you to enter the number of copies.</td> </tr> <tr> <td data-bbox="239 1590 438 1646">Preview</td> <td data-bbox="438 1590 1436 1646">Displays a preview of the image before printing, copying, or sending faxes.</td> </tr> <tr> <td data-bbox="239 1646 438 1702"></td> <td data-bbox="438 1646 1436 1702">Starts printing, copying, scanning, or sending faxes.</td> </tr> </table>	Presets	Displays the preset list. You can register current setting as a preset, or load registered presets.	Copies	Displays the on-screen keypad allowing you to enter the number of copies.	Preview	Displays a preview of the image before printing, copying, or sending faxes.		Starts printing, copying, scanning, or sending faxes.
Presets	Displays the preset list. You can register current setting as a preset, or load registered presets.								
Copies	Displays the on-screen keypad allowing you to enter the number of copies.								
Preview	Displays a preview of the image before printing, copying, or sending faxes.								
	Starts printing, copying, scanning, or sending faxes.								

## Job/Status Screen Configuration

Press the  button to display the Job/Status menu. You can check the status of the printer or the jobs.

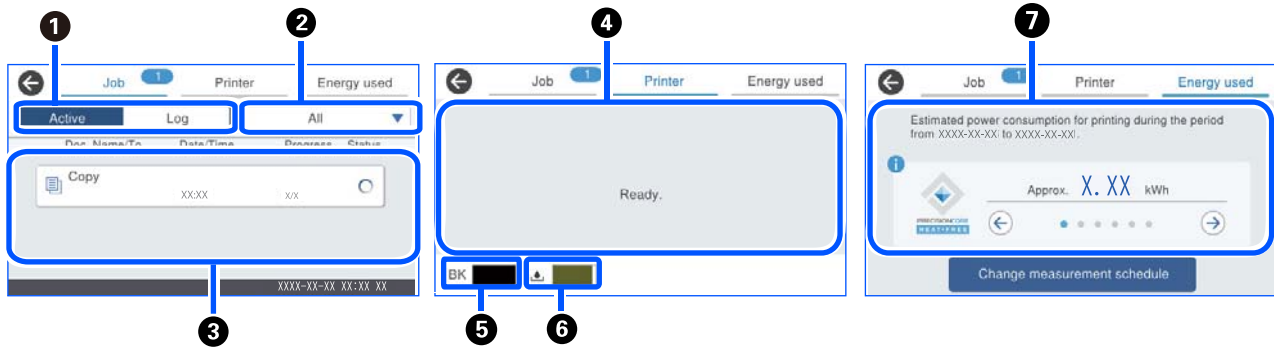

①	Switches the displayed lists.
②	Filter the jobs by functional.
③	When <b>Active</b> is selected, displays the list of ongoing jobs and jobs waiting to be processed. When <b>Log</b> is selected, displays the job history. You can cancel jobs or check the error code displayed in the history when the job has failed.
④	Displays any errors that have occurred in the printer. Select the error from the list to display the error message.
⑤	Indicates the approximate ink levels.
⑥	Indicates the approximate service life of the maintenance box.
⑦	Displays the estimated power consumption. The displayed power amount is a guideline value for general use and may vary depending on how you use this product. It is calculated using the following formula. <The amount of power required to print on one sheet of paper * with this product>×<The number of sheets printed in the past 7 days> See the following explanation for details on this product's power consumption. * The data used to print one sheet of paper is the TEC value measurement data ISO / IEC10561 1999 test pattern A. Regarding this product's power consumption The TEC value* <sup>1</sup> of this product is about 1/2 of the standard value* <sup>2</sup> needed to conform to the International Energy Star Program.

\*1 TEC is an abbreviation of Typical Electricity consumption and is the power consumption (kWh) for a standard week (5 days of repeated operation and sleep / off + 2 days of sleep / off). This value is used as a reference value to comply with the "International Energy Star Program".

The TEC value of this product is calculated independently by Epson based on the TEC standard of the International Energy Star Program measurement method. See the Epson website or contact Epson support for the TEC value of this product and its measurement conditions.

\*2 The standard values for conforming to the International Energy Star Program are set so that the top 25% of products with excellent energy-saving performance conform to this standard.

**Related Information**

➔ [“Error Code is Displayed on the Status Menu” on page 324](#)

**Reserve Job**









You can reserve jobs during copying or printing when you are not using the ADF or the Scanner Glass.

You do not need to perform any special actions to reserve jobs. If you select  during normal operation, the job runs as soon as the current job is complete.

You can reserve up to 150 of the following types of jobs including the current job.

- Print
- Copy
- Send Fax

**Guide to the Job Icon**

	Indicates a copy print job.
	Indicates a print job other than copying, such as printing on an external device.
	Indicates a report print job, such as printing a fax report.
	Indicates a data sending job such as scan data sending scan data.
	Indicates a fax reception job.
	Indicates a fax sending job.
	Indicates a fax reception print job.
	Indicates a data saving job such as saving to fax external memory.
	Indicates an email sending job such as scanning to email.

## Entering Characters

You can enter characters and symbols by using on-screen keyboard when you make network settings, and so on.

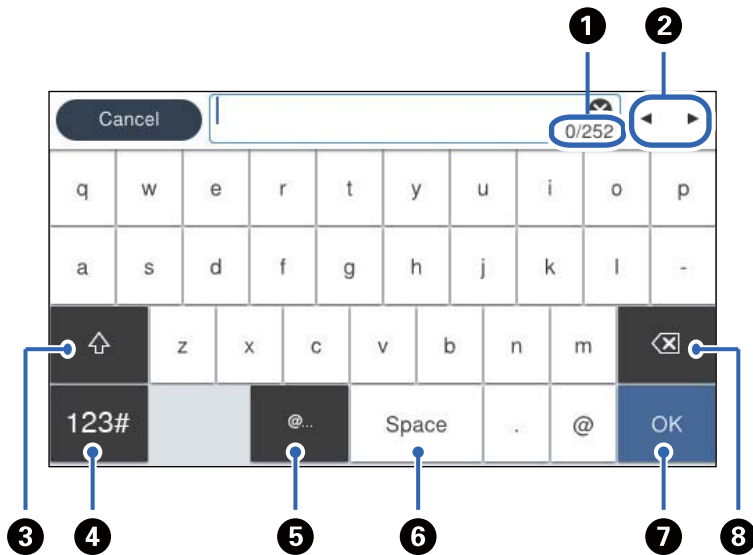

1	Indicates the character count.
2	Moves the cursor to the input position.
3	Switches between upper case and lower case or numbers and symbols.
4	Switches the character type. <div style="background-color: #cccccc; padding: 5px; display: inline-block;">123#</div> : You can enter numbers and symbols. <div style="background-color: #cccccc; padding: 5px; display: inline-block;">ABC</div> : You can enter letters.
5	Enters frequently used email domain addresses or URLs by simply selecting the item.
6	Enters a space.
7	Enters character.
8	Deletes a character to the left.

---

# Preparing the Printer and Making Initial Settings

Summary of Preparing the printer and Making Initial Settings. . . . .	36
Installing the Optional Paper Cassette Units. . . . .	38
Mounting an Authentication Device. . . . .	44
Creating a Network Connection and Making Settings. . . . .	45
Preparing and Setting Up the Printer According to Use. . . . .	63
Settings for Printing, Scanning, Copying and Faxing. . . . .	103
Problems when Making Settings. . . . .	137

## Summary of Preparing the printer and Making Initial Settings

This section explains the work required to connect the printer to a network and use it as a shared printer.

This work should be done by the printer administrator.

### Related Information

- ➔ [“Preparing the Printer” on page 36](#)
- ➔ [“Protecting Settings Using Panel Lock” on page 47](#)
- ➔ [“Configuring a Network Connection” on page 36](#)
- ➔ [“Summary of the Necessary Preparations for Each Feature” on page 37](#)
- ➔ [“Making Printer Settings” on page 37](#)

## Preparing the Printer

During the preparatory stage, install optional items or an authentication device as needed.

### Related Information

- ➔ [“Installing the Optional Paper Cassette Units” on page 38](#)
- ➔ [“Connecting the Authentication Device” on page 44](#)

## Protecting the Printer from Unauthorized Setting Changes

We recommend performing the following operation to prevent the user from changing the printer settings.

- Changing the Administrator Password
- Set the **Panel Lock**, a feature that allows the printer administrator to lock control panel menu items.

### Related Information

- ➔ [“Changing the Administrator Password” on page 46](#)
- ➔ [“Protecting Settings Using Panel Lock” on page 47](#)

## Configuring a Network Connection

Connect the printer to a network so that it can be used as a shared printer.

When connecting to a network that allows external connections such as TCP/IP settings and an Internet connection, set the proxy server as necessary.

### Related Information

- ➔ [“Creating a Network Connection and Making Settings” on page 45](#)



## Summary of the Necessary Preparations for Each Feature

Perform the following operations according to how you will use the printer and the environment in which it will be used.

Items	Description
Configuring a Mail Server	Configure the mail server if you want to forward the scanned data or received fax data to an e-mail, or notify a specific person of the printer status by email. <a href="#">“Configuring a Mail Server” on page 65</a>
Setting a Shared Network Folder	Set when sending scanned data or received fax data to a shared folder.
Making Contacts Available	Set when registering destinations for fax, email, scan data, and fax forwarding data to the contacts list. <a href="#">“Contacts Registration” on page 87</a>
Settings to Use Users Information on the LDAP Server as Destinations	If you are using an LDAP server, set it so that you can use the LDAP server’s contacts from the printer.
Initial Settings for Printing	Customize the paper feed device settings and print default settings to suit your environment. Make settings to use printing services provided by other companies.
Preparing Scanning or Copying	Use the scan function from the computer, the scan to XXX function from the printer’s control panel, and set the output destination for the copies. <a href="#">“Preparing to Scan” on page 113</a>
Making Fax Features Available	Connect to a telephone line and set the fax sending reception settings.

For security settings and other management settings for the printer, see the related information link below.

### Related Information

- ➔ [“Preparing and Setting Up the Printer According to Use” on page 63](#)
- ➔ [“Settings for Printing, Scanning, Copying and Faxing” on page 103](#)
- ➔ [“Administrator Information” on page 414](#)

## Making Printer Settings

Several methods are available when you make settings for the printer.

### Related Information

- ➔ [“Setting from the Printer’s Control Panel” on page 38](#)
- ➔ [“Setting Using Web Config from a Computer” on page 38](#)
- ➔ [“Setting Using Epson Device Admin from a Computer \(Windows Only\)” on page 38](#)

## Setting from the Printer's Control Panel

If the panel lock is enabled, you will need an administrator password to operate the locked items.

See related information for more details.

### Related Information

➔ [“Changing the Administrator Password” on page 19](#)

## Setting Using Web Config from a Computer

Web Config is a built-in web page of the printer for configuring the printer's settings. You can operate the printer connected to the network from the computer.

To access Web Config, you need to have first assigned an IP address to the printer.

### Note:

- ❑ *Before setting the IP address, you can open Web Config by connecting the computer and printer directly with a LAN cable and specifying the default IP address.*
- ❑ *Since the printer uses a self-signed certificate when accessing HTTPS, a warning is displayed on the browser when you start Web Config; this does not indicate a problem and can be safely ignored.*
- ❑ *To open the administrative page after starting Web Config, you need to log in to the printer with the administrator password.*

See related information for more details.

### Related Information

➔ [“Changing the Administrator Password” on page 19](#)

➔ [“Application for Configuring Printer Operations \(Web Config\)” on page 355](#)

## Setting Using Epson Device Admin from a Computer (Windows Only)

Use Epson Device Admin when setting up multiple printers in a batch.

---

# Installing the Optional Paper Cassette Units

You can install up to 3 paper cassette units.

**Caution:**

- ❑ Make sure you turn off the printer, unplug the power cord from the printer, and disconnect any cables before starting installation. Otherwise, the power cord may be damaged resulting in fire or electric shock.
- ❑ The printer is heavy and should not be lifted or carried by less than two people. If any paper cassettes other than Paper Cassette 1 are installed, uninstall them before lifting the printer. When lifting the printer, two or more people should assume the correct positions as shown below.

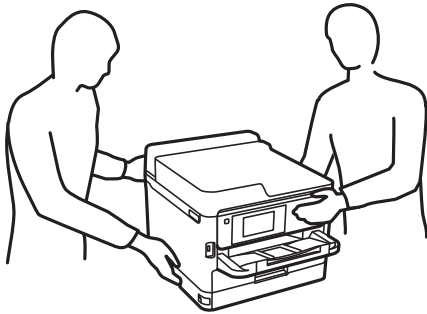

**Important:**

- ❑ Prepare a screwdriver to install and uninstall the optional cassette units.
- ❑ Use an appropriate size and type of screwdriver. Otherwise, you may not be able to turn the screw or you may accidentally remove another screw.

1. Turn off the printer by pressing the  button, and then unplug the power cord.
2. Disconnect any connected cables.
3. If other optional paper cassette units have been installed, uninstall them using a screwdriver.

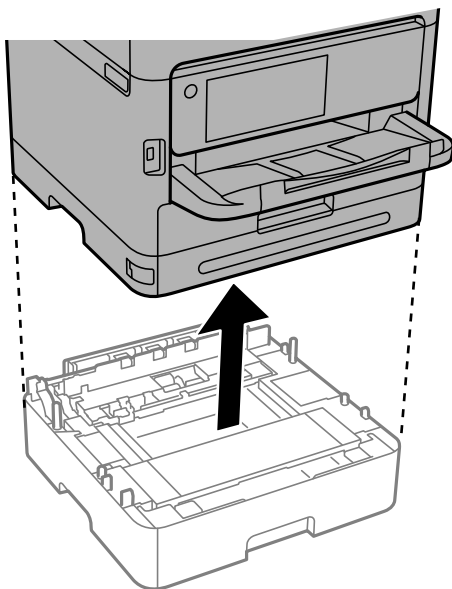

4. Remove the part on the back of the printer.

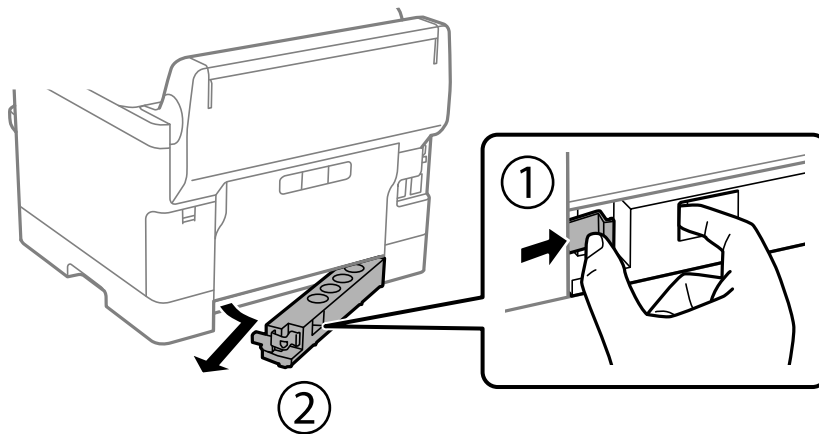

5. Remove the optional paper cassette unit from its box, and then remove any protective materials.
6. Check the items supplied.

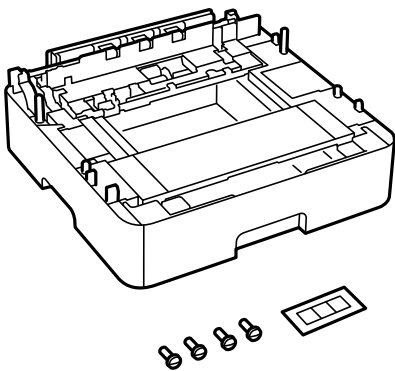

7. Place the lowest optional paper cassette unit where you want to set up the printer.
8. If you are only using one optional paper cassette unit, go to step 11. If you are using two or three optional cassette units, go to the next step.

9. Stack the optional paper cassette units on top of the lowest optional paper cassette unit, and then secure them with the screws using a screwdriver.

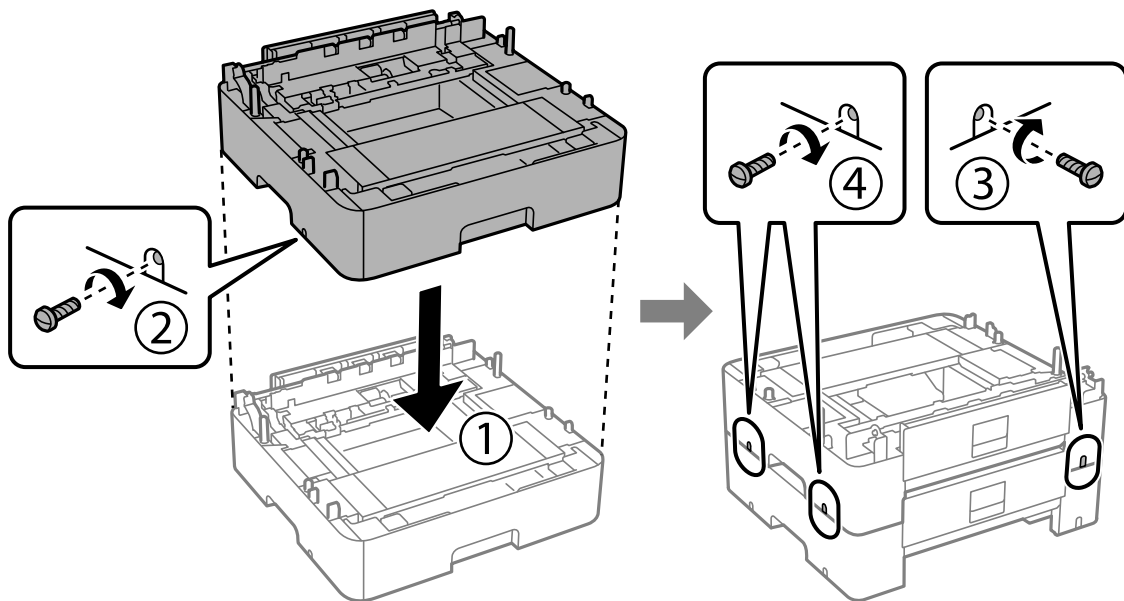

10. Repeat the previous step to add more optional paper cassette units.

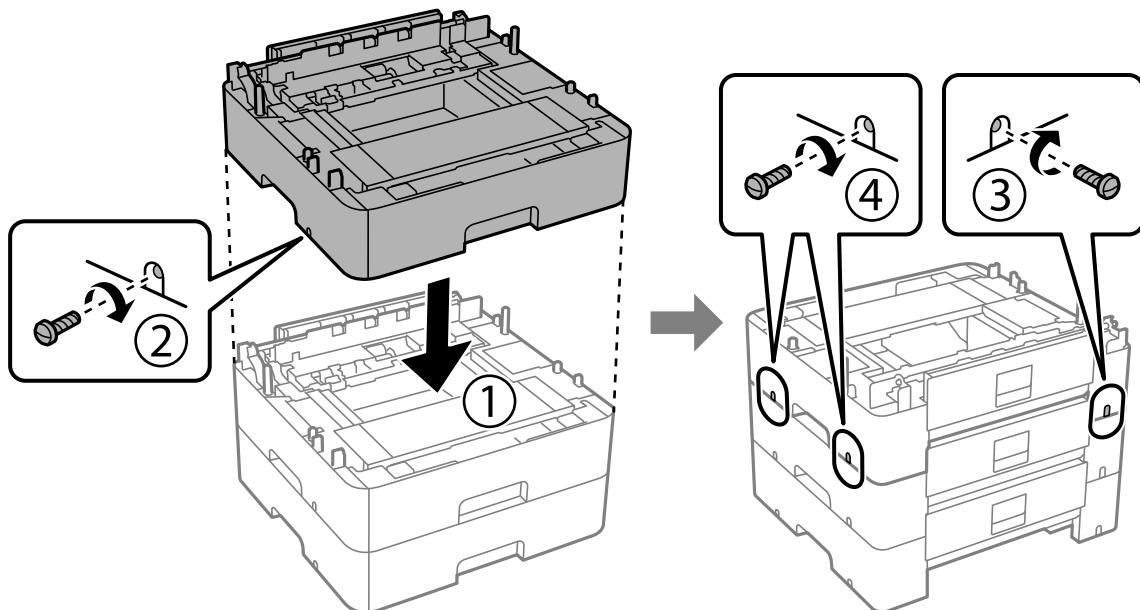

11. Lower the printer gently onto the optional paper cassette units aligning the corners, and then secure them with the screws using a screwdriver.

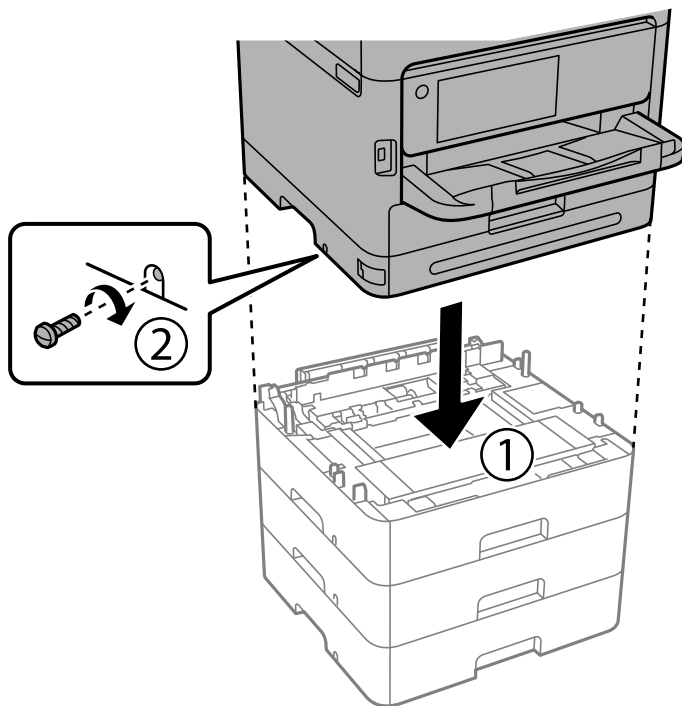

12. Secure the optional paper cassette units and the printer at the back and the right side with the screws using a screwdriver.

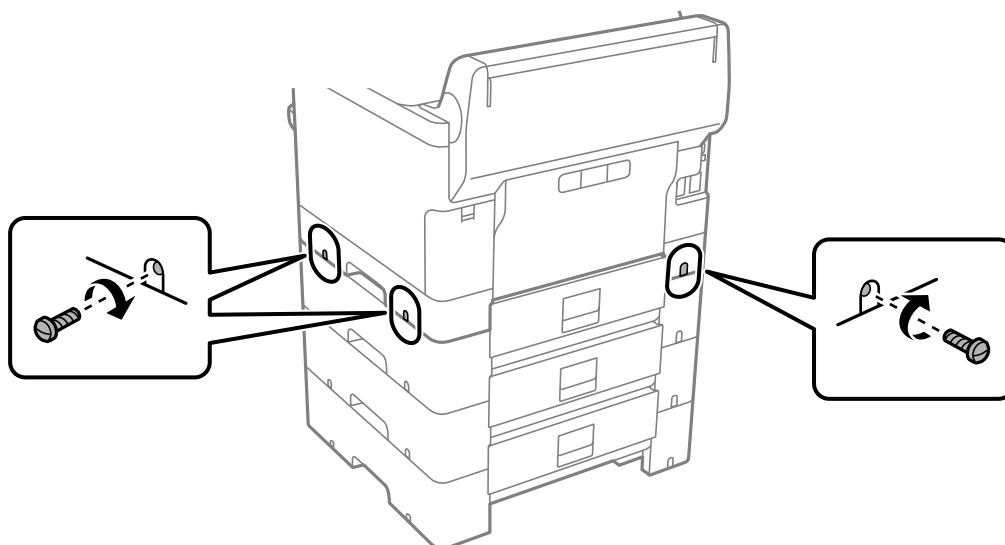

13. Attach the part that you removed in step 4 to the back of the lowest optional paper cassette unit.

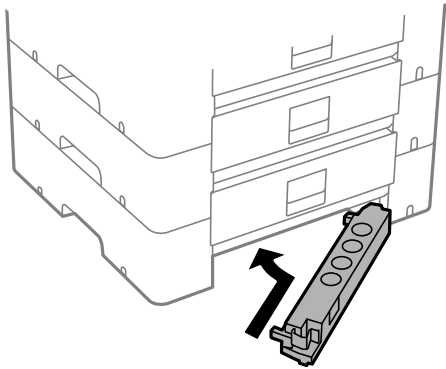

14. Place the sticker indicating the cassette number.

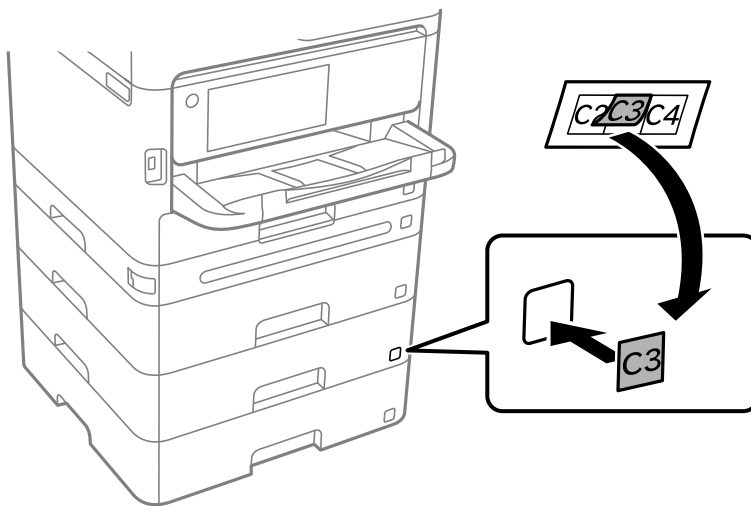

15. Reconnect the power cord and any other cables, and then plug in the printer.
16. Turn on the printer by pressing the  button.
17. Pull out and reinsert the optional paper cassette unit to check that the optional paper cassette unit is displayed on the **Paper Setting** screen.

**Note:**

When uninstalling the optional paper cassette unit, turn off the printer, unplug the power cord, disconnect any cables, and then perform the installation procedure in reverse.

Proceed with the printer driver settings.

**Related Information**

- ➔ [“Setting Available Optional Items” on page 63](#)
- ➔ [“Optional Paper Cassette Unit Code” on page 349](#)

## Mounting an Authentication Device

### Connecting the Authentication Device

You can connect the authentication device by using a USB cable.

**Note:**

*The authentication device can be used when using an authentication system.*



**Caution:**

*Connect an authentication device with the same model number as the authentication device that was used to confirm the authentication card.*

1. Peel off the sticker for the service port (a) on the back of the printer.

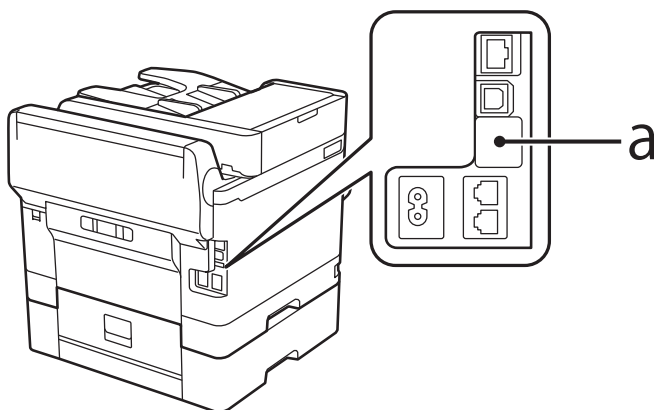

2. Connect the USB cable for the authentication device to the service port.

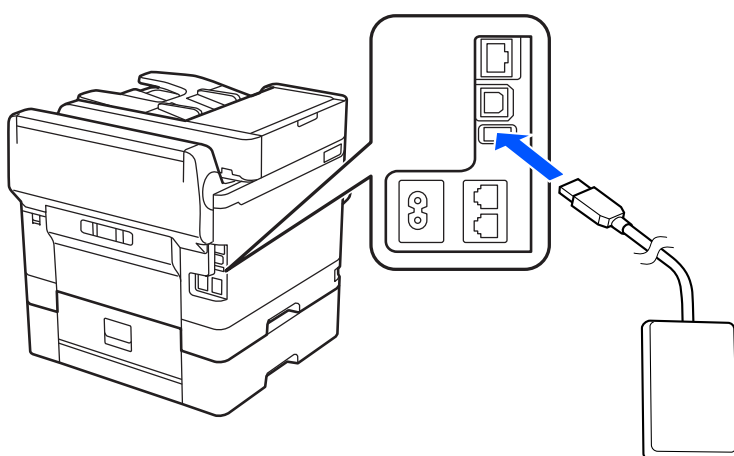

### Confirming the Connection Status of the Authentication Device

You can use several methods to confirm the connection status of the authentication device.



## Printer's control panel

**Settings > Authentication Device Status**

### Web Config

You can confirm from either of the following menus.

- Status tab > Product Status > Card Reader Status**
- Device Management tab > Card Reader > Check**

## Confirming the Authentication Card is Recognized

You can check that authentication cards can be recognized by using Web Config.

1. Enter the printer's IP address into a browser to access Web Config.  
Enter the printer's IP address from a computer that is connected to the same network as the printer.  
You can check the IP address of the printer from the following menu.  
**Settings > General Settings > Network Settings > Network Status > Wired LAN/Wi-Fi Status**
2. Enter the administrator password to log in as an administrator.
3. Select in the following order.  
**Device Management tab > Card Reader**
4. Hold the authentication card over the authentication device.
5. Click **Check**.  
The result is displayed.

## Troubleshooting the Authentication Device

### Cannot Read the Authentication Card

Check the following.

- Check if the authentication device is connected to the printer correctly.  
Make sure you connect the authentication device to the service port of the printer.
- Check that the authentication device and the authentication card are certified.  
Contact your dealer for information on supported authentication devices and cards.

---

## Creating a Network Connection and Making Settings

This section explains the necessary settings so that users in the same network can use the printer.

## Changing the Administrator Password

An administrator password is set for the printer. We recommend changing the initial password before using the printer.

If you forget the administrator password, you will not be able to change the settings for items that have been locked using **Panel Lock**, and you will need to contact service support to have it unlocked.

### Related Information

- ➔ [“Notes on the Administrator Password” on page 19](#)
- ➔ [“Changing the Administrator Password from the Control Panel” on page 46](#)
- ➔ [“Changing the Administrator Password from the Computer” on page 46](#)

## Changing the Administrator Password from the Control Panel

1. Select **Settings** on the printer's control panel.
2. Select **General Settings > System Administration > Security Settings > Admin Settings > Admin Password > Change**.

3. Enter a current password.

**Note:**

*See the related information below for the default of administrator password.*

4. Follow the on-screen instructions to set a new password.

**Note:**

*To restore the administrator password to its default, select the following menus on the control panel.*

**General Settings > System Administration > Security Settings > Admin Settings > Admin Password > Restore Default Settings**

### Related Information

- ➔ [“Changing the Administrator Password” on page 19](#)

## Changing the Administrator Password from the Computer

You can set the administrator password using Web Config. When using Web Config, it is necessary to connect the printer to the network. If the printer is not connect to the network, connect the to the computer with an ethernet cable directly.

1. Enter the printer's IP address into a browser to access Web Config.  
Enter the printer's IP address from a computer that is connected to the same network as the printer.

You can check the IP address of the printer from the following menu.

**Settings > General Settings > Network Settings > Network Status > Wired LAN/Wi-Fi Status**

2. Enter the administrator password to log in as an administrator.  
Select **Log in**, and then enter the administrator password, and click **OK**.

3. Select **Product Security-Change Administrator Password**.
4. Enter a password in **Current password** and **New Password** and **Confirm New Password**. Enter the user name, if necessary.

**Note:**

See the related information below for the default of administrator password.

5. Select **OK**.

**Note:**

To restore the administrator password to the initial password, select **Restore Default Settings** on the **Change Administrator Password** screen.

### Related Information

- ➔ [“Changing the Administrator Password” on page 19](#)

## Protecting Settings Using Panel Lock

To prevent unauthorized users from viewing or changing printer settings or network settings when connected to the network, administrators can lock the control panel menu items by using the Panel Lock function. You need to log in as an administrator to operate the locked menu items.

**Note:**

You can change the password later.

### Related Information

- ➔ [“Setting the Control Panel” on page 415](#)

## Enabling the Lock Setting from the Control Panel

1. Select **Settings** on the printer's control panel.
2. Select **General Settings > System Administration > Security Settings > Admin Settings**.
3. Select **On** on **Lock Setting**.

Check that  is displayed on the home screen.

### Related Information

- ➔ [“Default Value of the Administrator Password” on page 19](#)

## Enabling the Lock Setting from a Computer

1. Enter the printer's IP address into a browser to access Web Config.  
Enter the printer's IP address from a computer that is connected to the same network as the printer.  
You can check the IP address of the printer from the following menu.  
**Settings > General Settings > Network Settings > Network Status > Wired LAN/Wi-Fi Status**

2. Enter the password, and then click **OK**.
3. Select in the following order.  
**Device Management** tab > **Control Panel**
4. On the **Panel Lock**, select **ON**.
5. Click **OK**.
6. Check that  is displayed on the home screen on the printer's control panel.

**Related Information**

- ➔ [“Default Value of the Administrator Password” on page 19](#)
- ➔ [“Application for Configuring Printer Operations \(Web Config\)” on page 355](#)

## Connecting the Printer to the Network

You can connect the printer to the network in several ways.

- Connect by using advanced settings on the control panel.
- Connect by using the installer on the website or on the software disc.

This section explains the procedure to connect the printer to the network using the printer's control panel.

### Before Making Network Connection

To connect to the network, check the connection method and setting information for connection in advance.

#### *Gathering Information on the Connection Setting*

Prepare the necessary setting information to connect. Check the following information in advance.

Divisions	Items	Note
Device connection method	<input type="checkbox"/> Ethernet <input type="checkbox"/> Wi-Fi	Decide how to connect the printer to the network. For Wired LAN, connects to the LAN switch. For Wi-Fi, connects to the network (SSID) of the access point.
LAN connection information	<input type="checkbox"/> IP address <input type="checkbox"/> Subnet mask <input type="checkbox"/> Default gateway	Decide the IP address to assign to the printer. When you assign the IP address statically, all values are required. When you assign the IP address dynamically using the DHCP function, this information is not required because it is set automatically.

Divisions	Items	Note
Wi-Fi connection information	<input type="checkbox"/> SSID <input type="checkbox"/> Password	These are the SSID (network name) and the password of the access point that the printer connects to.  If MAC address filtering has been set, register the MAC address of the printer in advance to register the printer.  See the following for the supported standards.  <a href="#">"Wi-Fi Specifications" on page 397</a>
DNS server information	<input type="checkbox"/> IP address for primary DNS <input type="checkbox"/> IP address for secondary DNS	These are required when specifying DNS servers. The secondary DNS is set when the system has a redundant configuration and there is a secondary DNS server.  If you are in a small organization and do not set the DNS server, set the IP address of the router.
Proxy server information	<input type="checkbox"/> Proxy server name	Set this when your network environment uses the proxy server to access the internet from the intranet, and you use the function that the printer directly accesses to the internet.  For the following functions, the printer directly connects to the internet .  <input type="checkbox"/> Epson Connect Services <input type="checkbox"/> Cloud services of other companies <input type="checkbox"/> Firmware updating
Port number information	<input type="checkbox"/> Port number to release	Check the port number used by the printer and computer, then release the port that is blocked by a firewall, if necessary.  See the following for the port number used by the printer.  <a href="#">"Using Port for the Printer" on page 395</a>

### **IP Address Assignment**

These are the following types of IP address assignment.

#### **Static IP address:**

Assign the predetermined IP address to the printer (host) manually.

The information to connect to the network (subnet mask, default gateway, DNS server and so on) need to be set manually.

The IP address does not change even when the device is turned off, so this is useful when you want to manage devices with an environment where you cannot change the IP address or you want to manage devices using the IP address. We recommend settings to the printer, server, etc. that many computers access. Also, when using security features such as IPsec / IP filtering, assign a fixed IP address so that the IP address does not change.

#### **Automatic assignment by using DHCP function (dynamic IP address):**

Assign the IP address automatically to the printer (host) by using the DHCP function of the DHCP server or router.

The information to connect to the network (subnet mask, default gateway, DNS server and so on) is set automatically, so you can easily connect the device to the network.

If the device or the router is turned off, or depending on the DHCP server settings, IP address may change when re-connecting.

We recommend managing devices other than the IP address and communicating with protocols that can follow the IP address.

**Note:**

*When you use the IP address reservation function of the DHCP, you can assign the same IP address to the devices at any time.*

### **DNS Server and Proxy Server**

The DNS server has a host name, domain name of the email address, etc. in association with the IP address information.

Communication is impossible if the other party is described by host name, domain name, etc. when the computer or the printer performs IP communication.

Queries the DNS server for that information and gets the IP address of the other party. This process is called name resolution.

Therefore, the devices such as computers and printers can communicate using the IP address.

Name resolution is necessary for the printer to communicate using the email function or Internet connection function.

When you use those functions, make the DNS server settings.

When you assign the printer's IP address by using the DHCP function of the DHCP server or router, it is automatically set.

The proxy server is placed at the gateway between the network and the Internet, and it communicates to the computer, printer, and Internet (opposite server) on behalf of each of them. The opposite server communicates only to the proxy server. Therefore, printer information such as the IP address and port number cannot be read and increased security is expected.

When you connect to the Internet via a proxy server, configure the proxy server on the printer.

## **Connecting to the Network from the Control Panel**

Connect the printer to the network by using the printer's control panel.

### **Assigning the IP Address**

Set up the basic items such as **IP Address**, **Subnet Mask**, **Default Gateway**.

This section explains the procedure for setting a static IP address.

1. Turn on the printer.
2. Select **Settings > General Settings > Network Settings** > on the home screen on the printer's control panel.
3. Select **Advanced > TCP/IP**.

**Note:**

*You need to enter the administrator password for the network.*

4. Select **Manual** for **Obtain IP Address**.

When you set the IP address automatically by using the DHCP function of router, select **Auto**. In that case, the **IP Address**, **Subnet Mask**, and **Default Gateway** on step 5 to 6 are also set automatically, so go to step 7.

5. Enter the IP address.  
Confirm the value reflected on the previous screen.
6. Set up the **Subnet Mask** and **Default Gateway**.  
Confirm the value reflected on the previous screen.



**Important:**

*If the combination of the **IP Address**, **Subnet Mask** and **Default Gateway** is incorrect, **Start Setup** is inactive and cannot proceed with the settings. Confirm that there is no error in the entry.*

7. Enter the IP address for the primary DNS server.  
Confirm the value reflected on the previous screen.  
  
When you select **Auto** for the IP address assignment settings, you can select the DNS server settings from **Manual** or **Auto**. If you cannot obtain the DNS server address automatically, select **Manual** and enter the DNS server address. Then, enter the secondary DNS server address directly. If you select **Auto**, go to step 9.
8. Enter the IP address for the secondary DNS server.  
Confirm the value reflected on the previous screen.
9. Tap **Start Setup**.

### Setting the Proxy Server

Set up the proxy server if both of the following are true.

- The proxy server is built for Internet connection.
- When using a function in which a printer directly connects to the Internet, such as Epson Connect service or another company's cloud services.

1. Select **Settings** on the home screen.  
When making settings after IP address setting, the **Advanced** screen is displayed. Go to step 3.
2. Select **General Settings > Network Settings > Advanced**.
3. Select **Proxy Server**.
4. Select **Use** for **Proxy Server Settings**.
5. Enter the address for the proxy server by IPv4 or FQDN format.  
Confirm the value reflected on the previous screen.
6. Enter the port number for the proxy server.  
Confirm the value reflected on the previous screen.
7. Tap **Start Setup**.

### Connecting to Ethernet

Connect the printer to the network by using an Ethernet cable, and check the connection.

1. Connect the printer and hub (LAN switch) by Ethernet cable.
2. Select **Settings** on the home screen.
3. Select **General Settings > Network Settings > Connection Check**.

The connection diagnosis result is displayed. Confirm the connection is correct.

### Connecting to the Wireless LAN (Wi-Fi)

You can connect the printer to the wireless LAN (Wi-Fi) in several ways. Choose the connection method that matches the environment and conditions that you are using.

If you know the information for the wireless router such as SSID and password, you can make settings manually.

If the wireless router supports WPS, you can make settings by using push button setup.

After connecting the printer to the network, connect to the printer from the device that you want to use (computer, smart device, tablet, and so on.)

### Related Information

- ➔ [“Note when Using a Wi-Fi 5 GHz Connection” on page 52](#)
- ➔ [“Making Wi-Fi Settings by Entering the SSID and Password” on page 52](#)
- ➔ [“Making Wi-Fi Settings by Push Button Setup \(WPS\)” on page 53](#)
- ➔ [“Making Wi-Fi Settings by PIN Code Setup \(WPS\)” on page 54](#)

### Note when Using a Wi-Fi 5 GHz Connection

This printer normally uses W52 (36ch) as the channel when connecting to Wi-Fi Direct (Simple AP). Since the channel for wireless LAN (Wi-Fi) connection is selected automatically, the channel used may differ when used at the same time as a Wi-Fi Direct connection. Sending data to the printer may be delayed if the channels are different. If it does not interfere with use, connect to the SSID in the 2.4 GHz band. In the 2.4 GHz frequency band, the channels used will match.

When setting the wireless LAN to 5 GHz, we recommend disabling Wi-Fi Direct.

### Making Wi-Fi Settings by Entering the SSID and Password

You can set up a Wi-Fi network by entering the information necessary to connect to a wireless router from the printer's control panel. To set up using this method, you need the SSID and password for a wireless router.

#### Note:

*If you are using an wireless router with its default settings, the SSID and password are on the label. If you do not know the SSID and password, contact the person who set up the wireless router, or see the documentation provided with the wireless router.*

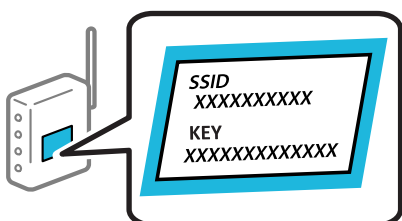



1. Tap  on the home screen.

2. Select **Router**.

3. Tap **Start Setup**.

If the network connection is already set up, the connection details are displayed. Tap **Change to Wi-Fi connection**. or **Change Settings** to change the settings.

4. Select **Wi-Fi Setup Wizard**.

5. Follow the on-screen instructions to select the SSID, enter the password for the wireless router, and start setup.

If you want to check the network connection status for the printer after setup is complete, see the related information link below for details.

**Note:**

If you do not know the SSID, check if it is written on the label of the wireless router. If you are using the wireless router with its default settings, use the SSID written on the label. If you cannot find any information, see the documentation provided with the wireless router.

The password is case-sensitive.

If you do not know the password, check if the information is written on the label of the wireless router. On the label, the password may be written "Network Key", "Wireless Password", and so on. If you are using the wireless router with its default settings, use the password written on the label.

**Related Information**

➔ [“Checking the Printer's Network Connection Status \(Network Connection Report\)” on page 278](#)

➔ [“Printing a Network Connection Report” on page 54](#)

**Making Wi-Fi Settings by Push Button Setup (WPS)**

You can automatically set up a Wi-Fi network by pressing a button on the wireless router. If the following conditions are met, you can set up by using this method.

The wireless router is compatible with WPS (Wi-Fi Protected Setup).

The current Wi-Fi connection was established by pressing a button on the wireless router.

**Note:**

If you cannot find the button or you are setting up using the software, see the documentation provided with the wireless router.

1. Tap  on the home screen.

2. Select **Router**.

3. Tap **Start Setup**.

If the network connection is already set up, the connection details are displayed. Tap **Change to Wi-Fi connection**. or **Change Settings** to change the settings.

4. Select **Push Button Setup(WPS)**.

5. Follow the on-screen instructions.

If you want to check the network connection status for the printer after setup is complete, see the related information link below for details.

**Note:**

*If connection fails, restart the wireless router, move it closer to the printer, and try again. If it still does not work, print a network connection report and check the solution.*

### Related Information

- ➔ [“Printing a Network Connection Report” on page 54](#)

### Making Wi-Fi Settings by PIN Code Setup (WPS)

You can automatically connect to an wireless router by using a PIN code. You can use this method to set up if an wireless router is capable of WPS (Wi-Fi Protected Setup). Use a computer to enter a PIN code into the wireless router.

1. Tap  on the home screen.

2. Select **Router**.

3. Tap **Start Setup**.

If the network connection is already set up, the connection details are displayed. Tap **Change to Wi-Fi connection**, or **Change Settings** to change the settings.

4. Select **Others > PIN Code Setup(WPS)**

5. Follow the on-screen instructions.

If you want to check the network connection status for the printer after setup is complete, see the related information link below for details.

**Note:**

*See the documentation provided with your wireless router for details on entering a PIN code.*

### Related Information

- ➔ [“Printing a Network Connection Report” on page 54](#)

## Troubleshooting Network Connections

### Printing a Network Connection Report

You can print a network connection report to check the status between the printer and the wireless router.

1. Select **Settings** on the home screen.

2. Select **General Settings > Network Settings > Connection Check**.

The connection check starts.

3. Select **Print Check Report**.

4. Print the network connection report.

If an error has occurred, check the network connection report, and then follow the printed solutions.

#### **Related Information**

➔ [“Network Settings” on page 366](#)

➔ [“Messages and Solutions on the Network Connection Report” on page 58](#)

## **Cannot Connect to the Network**

### ***The IP address is incorrectly assigned.***

If the IP address assigned to the printer is 169.254.XXX.XXX, and the subnet mask is 255.255.0.0, the IP address may not be assigned correctly.

**Settings** > **General Settings** > **Network Settings** > **Advanced** > **TCP/IP** on the printer's control panel, and then check the IP address and the subnet mask assigned to the printer.

Restart the wireless router or reset the network settings for the printer.

If the printer network settings are incorrect, reconfigure the printer network settings according to the network environment.

#### **Related Information**

➔ [“Connecting to the Network from the Control Panel” on page 50](#)

### ***The printer has been connected by Ethernet using devices that support IEEE802.3az (Energy Efficient Ethernet).***

When you connect the printer by Ethernet using devices that support IEEE802.3az (Energy Efficient Ethernet), the following problems may occur depending on the hub or router that you are using.

- Connection becomes unstable, the printer is connected and disconnected again and again.
- Cannot connect to the printer.
- The communication speed becomes slow.

Follow the steps below to disable IEEE802.3az for the printer and then connect.

1. Remove the Ethernet cable connected to the computer and the printer.
2. When IEEE802.3az for the computer is enabled, disable it.  
See the documentation provided with the computer for details.
3. Connect the computer and the printer with an Ethernet cable directly.
4. On the printer, print a network connection report.  
[“Printing a Network Connection Report” on page 54](#)
5. Check the printer's IP address on the network connection report.

6. On the computer, access Web Config.  
Launch a Web browser, and then enter the printer's IP address.  
[“Running Web Config on a Web Browser” on page 355](#)
  7. Select the **Network** tab > **Wired LAN**.
  8. Select **OFF** for **IEEE 802.3az**.
  9. Click **Next**.
  10. Click **OK**.
  11. Remove the Ethernet cable connected to the computer and the printer.
  12. If you disabled IEEE802.3az for the computer in step 2, enable it.
  13. Connect the Ethernet cables that you removed in step 1 to the computer and the printer.
- If the problem still occurs, devices other than the printer may be causing the problem.

***Something is wrong with the network devices for Wi-Fi connection.***

Try the following if you can reset the wireless LAN router in your environment.

Turn off the devices you want to connect to the network. Wait for about 10 seconds, and then turn on the devices in the following order; wireless router, computer or smart device, and then printer. Move the printer and computer or smart device closer to the wireless router to help with radio wave communication, and then try to make network settings again.

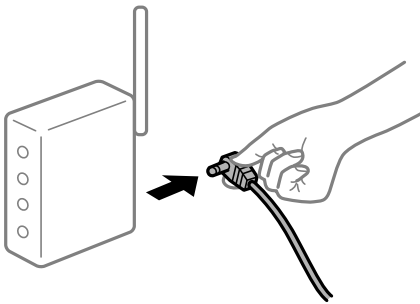

***Devices cannot receive signals from the wireless router because they are too far apart.***

Try the following if you can move the device within the setup environment.

After moving the computer or the smart device and the printer closer to the wireless router, turn off the wireless router, and then turn it back on.

***When changing the wireless router, the settings do not match the new router.***

Make the connection settings again so that they match the new wireless router.

**Related Information**

➔ [“Connecting to the Network from the Control Panel” on page 50](#)

**The SSIDs connected from the computer or smart device and computer are different.**

When you are using multiple wireless routers at the same time or the wireless router has multiple SSIDs and devices are connected to different SSIDs, you cannot connect to the wireless router.

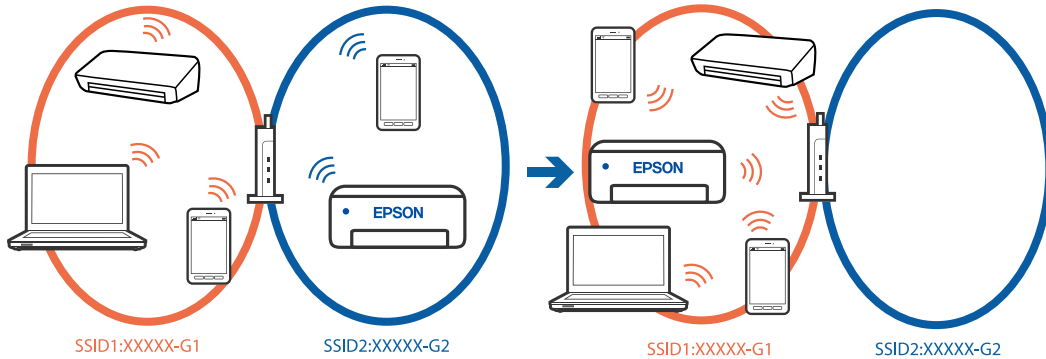

Connect the computer or smart device to the same SSID as the printer.

- Check the SSID that the printer is connected to by printing out the network connection check report.
- On all of the computers and smart devices you want to connect to the printer, check the name of the Wi-Fi or network you are connected to.
- If the printer and your computer or smart device are connected to different networks, reconnect the device to the SSID that the printer is connected to.

**A privacy separator on the wireless router is available.**

Most wireless routers have a separator function that blocks communication between devices within the same SSID. If you cannot communicate between the printer and the computer or smart device even if they are connected to the same network, disable the separator function on the wireless router. See the manual provided with the wireless router for details.

## Messages and Solutions on the Network Connection Report

Check the messages and error codes on the network connection report, and then follow the solutions.

Check Network Connection

---

Check Result FAIL

---

Error code (E-2)

See the Network Status and check if the Network Name (SSID) is the SSID you want to connect.  
If the SSID is correct, make sure to enter the correct password and try again.

If your problems persist,  
see your documentation for help and networking tips.

---

Checked Items

Wireless Network Name (SSID) Check	FAIL
Communication Mode Check	Unchecked
Security Mode Check	Unchecked
MAC Address Filtering Check	Unchecked
Security Key/Password Check	Unchecked
IP Address Check	Unchecked
Detailed IP Setup Check	Unchecked

---

Network Status

Printer Name	EPSON XXXXXX
Printer Model	XX-XXX Series
IP Address	169.254.137.8
Subnet Mask	255.255.0.0
Default Gateway	
Network Name (SSID)	EpsonNet
Security	None
Signal Strength	Poor
MAC Address	F8:D0:27:40:C0:AC

a. Error code

b. Messages on the Network Environment

### Related Information

- ➔ “E-1” on page 59
- ➔ “E-2, E-3, E-7” on page 59
- ➔ “E-5” on page 60
- ➔ “E-6” on page 60
- ➔ “E-8” on page 60
- ➔ “E-9” on page 61
- ➔ “E-10” on page 61
- ➔ “E-11” on page 61
- ➔ “E-12” on page 62
- ➔ “E-13” on page 62
- ➔ “Message on the Network Environment” on page 63

### **E-1**

#### **Solutions:**

- Make sure the Ethernet cable is securely connected to your printer and to your hub or other network device.
- Make sure your hub or other network device is turned on.
- If you want to connect the printer by Wi-Fi, make Wi-Fi settings for the printer again because it is disabled.

### **E-2, E-3, E-7**

#### **Solutions:**

- Make sure your wireless router is turned on.
- Confirm that your computer or device is connected correctly to the wireless router.
- Turn off the wireless router. Wait for about 10 seconds, and then turn it on.
- Place the printer closer to your wireless router and remove any obstacles between them.
- If you have entered the SSID manually, check if it is correct. Check the SSID from the **Network Status** part on the network connection report.
- If an wireless router has multiple SSIDs, select the SSID that is displayed. When the SSID is using a non-compliant frequency, the printer does not display them.
- If you are using push button setup to establish a network connection, make sure your wireless router supports WPS. You cannot use push button setup if your wireless router does not support WPS.
- Makes sure your SSID uses only ASCII characters (alphanumeric characters and symbols). The printer cannot display an SSID that contains non-ASCII characters.
- Makes sure you know your SSID and password before connecting to the wireless router. If you are using a wireless router with its default settings, the SSID and password are located on a label on the wireless router. If you do not know your SSID and password, contact the person who set up the wireless router, or see the documentation provided with the wireless router.
- If you are connecting to an SSID generated from a tethering smart device, check for the SSID and password in the documentation provided with the smart device.
- If your Wi-Fi connection suddenly disconnects, check for the conditions below. If any of these conditions are applicable, reset your network settings by downloading and running the software from the following website.  
<https://epson.sn> > **Setup**
  - Another smart device was added to the network using push button setup.
  - The Wi-Fi network was set up using any method other than push button setup.

#### **Related Information**

- ➔ [“Making Settings for Connecting to the Computer” on page 278](#)
- ➔ [“Connecting to the Wireless LAN \(Wi-Fi\)” on page 52](#)

## **E-5**

### **Solutions:**

Make sure the wireless router's security type is set to one of the following. If it is not, change the security type on the wireless router, and then reset the printer's network settings.

- WEP-64 bit (40 bit)
- WEP-128 bit (104 bit)
- WPA PSK (TKIP/AES)\*
- WPA2 PSK (TKIP/AES)\*
- WPA (TKIP/AES)
- WPA2 (TKIP/AES)
- WPA3-SAE (AES)
- WPA2/WPA3-Enterprise

\* WPA PSK is also known as WPA Personal. WPA2 PSK is also known as WPA2 Personal.

## **E-6**

### **Solutions:**

- Check if MAC address filtering is disabled. If it is enabled, register the printer's MAC address so that it is not filtered. See the documentation provided with the wireless router for details. You can check the printer's MAC address from the **Network Status** part on the network connection report.
- If your wireless router is using shared authentication with WEP security, make sure the authentication key and index are correct.
- If the number of connectable devices on the wireless router is less than the number of network devices that you want to connect, make settings on the wireless router to increase the number of connectable devices. See the documentation provided with the wireless router to make settings.

### **Related Information**

➔ [“Making Settings for Connecting to the Computer” on page 278](#)

## **E-8**

### **Solutions:**

- Enable DHCP on the wireless router if the printer's Obtain IP Address setting is set to Auto.
- If the printer's Obtain IP Address setting is set to Manual, the IP address you manually set is invalid due to out of range (for example: 0.0.0.0). Set a valid IP address from the printer's control panel.

### **Related Information**

➔ [“Assigning the IP Address” on page 50](#)



## **E-9**

### **Solutions:**

Check the following.

- Devices are turned on.
- You can access the Internet and other computers or network devices on the same network from the devices you want to connect to the printer.

If still does not connect your printer and network devices after confirming the above, turn off the wireless router. Wait for about 10 seconds, and then turn it on. Then reset your network settings by downloading and running the installer from the following website.

<https://epson.sn> > **Setup**

### **Related Information**

➔ [“Making Settings for Connecting to the Computer” on page 278](#)

## **E-10**

### **Solutions:**

Check the following.

- Other devices on the network are turned on.
- Network addresses (IP address, subnet mask, and default gateway) are correct if you have set the printer's Obtain IP Address to Manual.

Reset the network address if they are incorrect. You can check the IP address, subnet mask, and default gateway from the **Network Status** part on the network connection report.

### **Related Information**

➔ [“Assigning the IP Address” on page 50](#)

## **E-11**

### **Solutions:**

Check the following.

- The default gateway address is correct if you set the printer's TCP/IP Setup setting to Manual.
- The device that is set as the default gateway is turned on.

Set the correct default gateway address. You can check the default gateway address from the **Network Status** part on the network connection report.

### **Related Information**

➔ [“Assigning the IP Address” on page 50](#)

## **E-12**

### **Solutions:**

Check the following.

- Other devices on the network are turned on.
- The network addresses (IP address, subnet mask, and default gateway) are correct if you are entering them manually.
- The network addresses for other devices (subnet mask and default gateway) are the same.
- The IP address does not conflict with other devices.

If still does not connect your printer and network devices after confirming the above, try the following.

- Turn off the wireless router. Wait for about 10 seconds, and then turn it on.
- Make network settings again using the installer. You can run it from the following website.  
<https://epson.sn> > **Setup**
- You can register several passwords on a wireless router that uses WEP security type. If several passwords are registered, check if the first registered password is set on the printer.

### **Related Information**

- ➔ [“Assigning the IP Address” on page 50](#)
- ➔ [“Making Settings for Connecting to the Computer” on page 278](#)

## **E-13**

### **Solutions:**

Check the following.

- Network devices such as a wireless router, hub, and router are turned on.
- The TCP/IP Setup for network devices has not been set up manually. (If the printer's TCP/IP Setup is set automatically while the TCP/IP Setup for other network devices is performed manually, the printer's network may differ from the network for other devices.)

If it still does not work after checking the above, try the following.

- Turn off the wireless router. Wait for about 10 seconds, and then turn it on.
- Make network settings on the computer that is on the same network as the printer using the installer. You can run it from the following website.  
<https://epson.sn> > **Setup**
- You can register several passwords on a wireless router that uses the WEP security type. If several passwords are registered, check if the first registered password is set on the printer.

### **Related Information**

- ➔ [“Assigning the IP Address” on page 50](#)
- ➔ [“Making Settings for Connecting to the Computer” on page 278](#)

### Message on the Network Environment

Message	Solution
The Wi-Fi environment needs to be improved. Turn the wireless router off and then turn it on. If the connection does not improve, see the documentation for the wireless router.	After moving the printer closer to the wireless router and removing any obstacles between them, turn off the wireless router. Wait for about 10 seconds, and then turn it on. If it still does not connect, see the documentation supplied with the wireless router.
*No more devices can be connected. Disconnect one of the connected devices if you want to add another one.	Computer and smart devices that can be connected simultaneously are connected in full in the Wi-Fi Direct (Simple AP) connection. To add another computer or smart device, disconnect one of the connected devices or connect it to the other network first.  You can confirm the number of wireless devices which can be connected simultaneously and the number of connected devices by checking the network status sheet or the printer's control panel.
The same SSID as Wi-Fi Direct exists in the environment. Change the Wi-Fi Direct SSID if you cannot connect a smart device to the printer.	On the printer's control panel, go to Wi-Fi Direct Setup screen and select the menu to change the setting. You can change the network name following after DIRECT-XX-. Enter within 22 characters.

#### Related Information

➔ ["Print Status Sheet:" on page 368](#)

## Preparing and Setting Up the Printer According to Use

### Setting Available Optional Items

To use an optional paper source when printing from a computer, you need to make settings on the printer driver.

#### Setting Available Optional Items - Windows

**Note:**

Log on to your computer as an administrator.

1. Open the **Optional Settings** tab from the printer properties.

- Windows 11

Click on the start button, and then select **All apps > Windows Tools > Control Panel > View devices and printers in Hardware and Sound**. Right-click on your printer, or press and hold it, select **Printer properties**, and then click the **Optional Settings** tab.

- Windows 10/Windows Server 2022/Windows Server 2019/Windows Server 2016

Click on the start button, and then select **Windows System > Control Panel > View devices and printers in Hardware and Sound**. Right-click on your printer, or press and hold it, select **Printer properties**, and then click the **Optional Settings** tab.

- ❑ Windows 8.1/Windows 8/Windows Server 2012 R2/Windows Server 2012  
Select **Desktop > Settings > Control Panel > View devices and printers** in **Hardware and Sound**. Right-click on your printer, or press and hold it, select **Printer properties**, and then click the **Optional Settings** tab.
  - ❑ Windows 7/Windows Server 2008 R2  
Click the start button, and select **Control Panel > Hardware and Sound > Scanner and Cameras**, and then check if the printer is displayed. Right-click on your printer, select **Printer properties**, and then click the **Optional Settings**.
  - ❑ Windows Vista/Windows Server 2008  
Click the start button, and then select **Control Panel > Printers** in **Hardware and Sound**. Right-click on your printer, select **Property**, and then click **Optional Settings**.
  - ❑ Windows XP/Windows Server 2003 R2/Windows Server 2003  
Click the start button, and select **Control Panel > Printers and Other Hardware > Scanner and Cameras**, and then check if the printer is displayed.
2. Select **Acquire from Printer**, and then click **Get**.
  3. Click **OK**.

## Setting Available Optional Items - Windows PostScript

**Note:**

*Log on to your computer as an administrator.*

1. Open the **Optional Settings** tab from the printer properties.
  - ❑ Windows 11  
Click on the start button, and then select **All apps > Windows Tools > Control Panel > View devices and printers** in **Hardware and Sound**. Right-click on your printer, or press and hold it and then select **Printer properties**. On the **Device Settings** tab.
  - ❑ Windows 10//Windows Server 2022/Windows Server 2019/Windows Server 2016  
Click on the start button, and then select **Windows System > Control Panel > View devices and printers** in **Hardware and Sound**. Right-click on your printer, or press and hold it and then select **Printer properties**, and then click the **Device Settings** tab.
  - ❑ Windows 8.1/Windows 8/Windows Server 2012 R2/Windows Server 2012  
Select **Desktop > Settings > Control Panel > View devices and printers** in **Hardware and Sound**. Right-click on your printer, or press and hold it and then select **Printer properties**, and then click the **Device Settings** tab.
  - ❑ Windows 7/Windows Server 2008 R2  
Click the start button, and select **Control Panel > View devices and printers** in **Hardware and Sound**. Right-click on your printer and select **Printer properties**, and then click the **Device Settings** tab.
  - ❑ Windows Vista/Windows Server 2008  
Click the start button, and select **Control Panel > Printers** in **Hardware and Sound**. Right-click on your printer and select **Properties**, and then click the **Device Settings** tab.
  - ❑ Windows XP/Windows Server 2003 R2/Windows Server 2003  
Click the start button, and select **Control Panel > Printers and Other Hardware > Printers and Faxes**. Right-click on your printer and select **Properties**, and then click the **Device Settings** tab.

2. Select the optional device in the **Installable Options** setting.
3. Click **OK**.

## Setting Available Optional Items - Mac OS

1. Select **System Preferences** from the Apple menu > **Printers & Scanners** (or **Print & Scan, Print & Fax**), and then select the printer. Click **Options & Supplies** > **Options** (or **Driver**).
2. Make settings according to the type of optional unit.
3. Click **OK**.

## Setting Available Optional Items - Mac OSPostScript

1. Select **System Preferences** from the Apple menu > **Printers & Scanners** (or **Print & Scan, Print & Fax**), and then select the printer. Click **Options & Supplies** > **Options** (or **Driver**).
2. Make settings according to the type of optional unit.
3. Click **OK**.

## Preparing to Send an E-mail

### Configuring a Mail Server

Set the mail server from Web Config.

Check below before setting up.

- The printer is connected to the network that can access the mail server.
- Email setting information of the computer that uses the same mail server as the printer.

**Note:**

- When you use the mail server on the Internet, confirm the setting information from the provider or website.
- You can also set the mail server from the control panel. Access as below.

**Settings > General Settings > Network Settings > Advanced > Email Server > Server Settings**

1. Enter the printer's IP address into a browser to access Web Config.  
Enter the printer's IP address from a computer that is connected to the same network as the printer.  
You can check the IP address of the printer from the following menu.  
**Settings > General Settings > Network Settings > Network Status > Wired LAN/Wi-Fi Status**
2. Enter the administrator password to log in as an administrator.
3. Select in the following order.  
**Network tab > Email Server > Basic**

4. Enter a value for each item.

5. Select **OK**.

The settings you have selected are displayed.

**Related Information**

➔ [“Default Value of the Administrator Password” on page 19](#)

**Mail Server Setting Items**

Items	Settings and Explanation	
Authentication Method	Specify the authentication method for the printer to access the mail server.	
	Off	Set when the mail server does not need authentication.
	SMTP AUTH	Authenticates on the SMTP server (outgoing mail server) when sending the email. The mail server needs to support SMTP authentication.
	POP before SMTP	Authenticates on the POP3 server (receiving mail server) before sending the email. When you select this item, set the POP3 server.
Authenticated Account	<p>If you select <b>SMTP AUTH</b> or <b>POP before SMTP</b> as the <b>Authentication Method</b>, enter the authenticated account name between 0 and 255 characters in ASCII (0x20-0x7E).</p> <p>When you select <b>SMTP AUTH</b>, enter the SMTP server account. When you select <b>POP before SMTP</b>, enter the POP3 server account.</p>	
Authenticated Password	<p>If you select <b>SMTP AUTH</b> or <b>POP before SMTP</b> as the <b>Authentication Method</b>, enter the authenticated password between 0 and 20 characters in ASCII (0x20-0x7E).</p> <p>When you select <b>SMTP AUTH</b>, enter the authenticated account for the SMTP server. When you select <b>POP before SMTP</b>, enter the authenticated account for the POP3 server.</p>	
Sender's Email Address	<p>Enter the sender's email address such as the email address of the system administrator. This is used when authenticating, so enter a valid email address that is registered to the mail server.</p> <p>Enter between 0 and 255 characters in ASCII (0x20-0x7E) except for : ( ) &lt; &gt; [ ] ; ¥. A period "." cannot be the first character.</p>	
SMTP Server Address	Enter between 0 and 255 characters using A-Z a-z 0-9 . - . You can use IPv4 or FQDN format.	
SMTP Server Port Number	Enter a number between 1 and 65535.	
Secure Connection	Select the encryption method of the communication to the mail server.	
	None	If you select <b>POP before SMTP</b> in <b>Authentication Method</b> , the connection is not encrypted.
	SSL/TLS	This is available when <b>Authentication Method</b> is set to <b>Off</b> or <b>SMTP AUTH</b> . Communication is encrypted from the start.
	STARTTLS	This is available when <b>Authentication Method</b> is set to <b>Off</b> or <b>SMTP AUTH</b> . Communication is not encrypted from the start, but depending on the network environment, whether the communication is encrypted or not is changed.

Items	Settings and Explanation
Certificate Validation	The certificate is validated when this is enabled. We recommend this is set to <b>Enable</b> . To set up, you need to import the CA Certificate to the printer. If an error message is displayed saying that the certificate is untrusted, see the following. <a href="#">"The Date and Time Are Incorrect" on page 339</a> <a href="#">"The Root Certificate Needs to be Updated" on page 339</a>
POP3 Server Address	If you select <b>POP before SMTP</b> as the <b>Authentication Method</b> , enter the POP3 server address between 0 and 255 characters using A-Z a-z 0-9 . - . You can use IPv4 or FQDN format.
POP3 Server Port Number	If you select <b>POP before SMTP</b> as the <b>Authentication Method</b> , enter a number between 1 and 65535.

### Checking a Mail Server Connection

You can check the connection to the mail server by performing the connection check.

1. Enter the IP address of the printer in the browser and start Web Config.  
 Enter the printer's IP address from a computer that is connected to the same network as the printer.
2. Enter the administrator password to log in as an administrator.
3. Select in the following order.  
**Network** tab > **Email Server** > **Connection Test**

4. Select **Start**.  
 The connection test to the mail server is started. After the test, the check report is displayed.

**Note:**

You can also check the connection to the mail server from the control panel. Access as below.

**Settings** > **General Settings** > **Network Settings** > **Advanced** > **Email Server** > **Connection Check**

### Related Information

➔ ["Default Value of the Administrator Password" on page 19](#)

### Mail Server Connection Test References

Messages	Cause
Connection test was successful.	This message appears when the connection with the server is successful.
SMTP server communication error. Check the following. - Network Settings	This message appears when <ul style="list-style-type: none"> <li><input type="checkbox"/> The printer is not connected to a network</li> <li><input type="checkbox"/> SMTP server is down</li> <li><input type="checkbox"/> Network connection is disconnected while communicating</li> <li><input type="checkbox"/> Received incomplete data</li> </ul>

Messages	Cause
POP3 server communication error. Check the following. - Network Settings	This message appears when <ul style="list-style-type: none"> <li><input type="checkbox"/> The printer is not connected to a network</li> <li><input type="checkbox"/> POP3 server is down</li> <li><input type="checkbox"/> Network connection is disconnected while communicating</li> <li><input type="checkbox"/> Received incomplete data</li> </ul>
An error occurred while connecting to SMTP server. Check the followings. - SMTP Server Address - DNS Server	This message appears when <ul style="list-style-type: none"> <li><input type="checkbox"/> Connecting to a DNS server failed</li> <li><input type="checkbox"/> Name resolution for an SMTP server failed</li> </ul>
An error occurred while connecting to POP3 server. Check the followings. - POP3 Server Address - DNS Server	This message appears when <ul style="list-style-type: none"> <li><input type="checkbox"/> Connecting to a DNS server failed</li> <li><input type="checkbox"/> Name resolution for a POP3 server failed</li> </ul>
SMTP server authentication error. Check the followings. - Authentication Method - Authenticated Account - Authenticated Password	This message appears when SMTP server authentication failed.
POP3 server authentication error. Check the followings. - Authentication Method - Authenticated Account - Authenticated Password	This message appears when POP3 server authentication failed.
Unsupported communication method. Check the followings. - SMTP Server Address - SMTP Server Port Number	This message appears when you try to communicate with unsupported protocols.
Connection to SMTP server failed. Change Secure Connection to None.	This message appears when an SMTP mismatch occurs between a server and a client, or when the server does not support SMTP secure connection (SSL connection).
Connection to SMTP server failed. Change Secure Connection to SSL/TLS.	This message appears when an SMTP mismatch occurs between a server and a client, or when the server requests to use an SSL/TLS connection for an SMTP secure connection.
Connection to SMTP server failed. Change Secure Connection to STARTTLS.	This message appears when an SMTP mismatch occurs between a server and a client, or when the server requests to use a STARTTLS connection for an SMTP secure connection.
The connection is untrusted. Check the following. - Date and Time	This message appears when the printer's date and time setting is incorrect or the certificate has expired.
The connection is untrusted. Check the following. - CA Certificate	This message appears when the printer does not have a root certificate corresponding to the server or a CA Certificate has not been imported.
The connection is not secured.	This message appears when the obtained certificate is damaged.
SMTP server authentication failed. Change Authentication Method to SMTP-AUTH.	This message appears when an authentication method mismatch occurs between a server and a client. The server supports SMTP AUTH.
SMTP server authentication failed. Change Authentication Method to POP before SMTP.	This message appears when an authentication method mismatch occurs between a server and a client. The server does not support SMTP AUTH.



Messages	Cause
Sender's Email Address is incorrect. Change to the email address for your email service.	This message appears when the specified sender's Email address is wrong.
Cannot access the printer until processing is complete.	This message appears when the printer is busy.

## Preparing a Shared Network Folder

### Setting a Shared Network Folder

Set a shared network folder to save a file from the printer.

When saving a file to the folder, the printer logs on as the user of the computer on which the folder was created.

Also, make sure you setup MS Network when creating the shared network folder.

### Creating the Shared Folder

#### Before Creating the Shared Folder

Before creating the shared folder, check the following.

- The printer is connected to the network where it can access the computer where the shared folder will be created.
- A multi-byte character is not included in the name of the computer where the shared folder will be created.

#### **Important:**

*When a multi-byte character is included in the computer name, saving the file to the shared folder may fail.*

*In that case, change to the computer that does not include the Multi-byte character in the name or change the computer name.*

*When changing the computer name, make sure to confirm with the administrator in advance because it may affect some settings, such as computer management, resource access, etc.*

### Checking the Network Profile

On the computer where the shared folder will be created, check whether folder sharing is available.

1. Log in to the computer where the shared folder will be created by the administrator authority user account.
2. Select **Control Panel > Network and Internet > Network and Sharing Center**.
3. Click **Change advanced sharing settings**, and then click  for the profile with **(current profile)** in the displayed network profiles.

4. Check whether **Turn on file and printer sharing** is selected on **File and Printer Sharing**.

If already selected, click **Cancel** and close the window.

When you change the settings, click **Save Changes** and close the window.

### Related Information

- ➔ [“Location Where the Shared Folder is Created and an Example of the Security” on page 70](#)

### Location Where the Shared Folder is Created and an Example of the Security

Depending on the location where the shared folder is created, security and convenience vary.

To operate the shared folder from the printers or other computers, the following reading and changing permissions for the folder are required.

#### **Sharing** tab > **Advanced Sharing** > **Permissions**

It controls the network access permission of the shared folder.

#### Access permission of **Security** tab

It controls permission of the network access and local access of the shared folder.

When you set **Everyone** to the shared folder that is created on the desktop, as an example of creating a shared folder, all users who can access the computer will be permitted access.

However, the user who does not have authority cannot access them because the desktop (folder) is under the control of the user folder, and then the security settings of the user folder are handed down to it. The user who is permitted access on the **Security** tab (user logged in and administrator in this case) can operate the folder.

See below to create the proper location.

This example is when creating the "scan\_folder" folder.

### Related Information

- ➔ [“Example of Configuration for File Servers” on page 70](#)
- ➔ [“Example of Configuration for a Personal Computer” on page 76](#)

### Example of Configuration for File Servers

This explanation is an example for creating the shared folder on the root of the drive on the shared computer, such as the file server under the following condition.

Access controllable users, such as someone who has the same domain of a computer to create a shared folder, can access the shared folder.

Set this configuration when you permit any user to read and write to the shared folder on the computer, such as the file server and the shared computer.

- Place for creating shared folder: Root of drive
- Folder path: C:\scan\_folder
- Access permission via network (Share Permissions): Everyone
- Access permission on file system (Security): Authenticated Users

1. Log in to the computer where the shared folder will be created by the administrator authority user account.
2. Start explorer.

3. Create the folder on the root of drive, and then name it "scan\_folder".

For the folder name, enter between 1 and 12 alphanumeric characters. If the character limit of the folder name is exceeded, you may not be able to access it normally by the varied environment.

4. Right click the folder, and then select **Properties**.

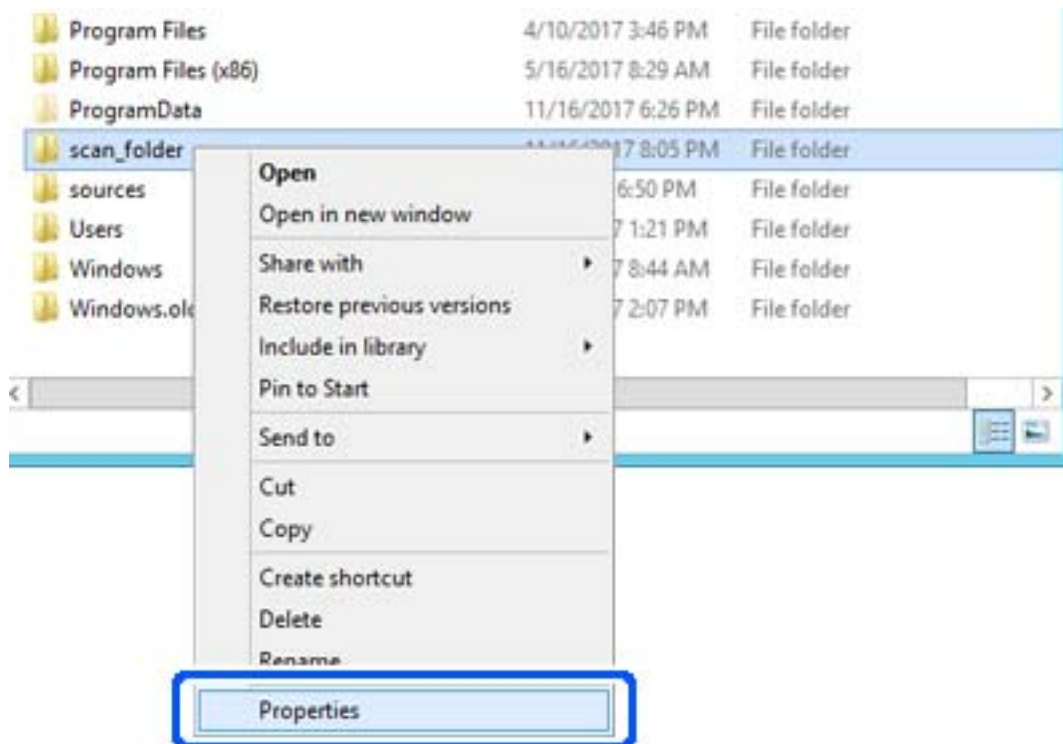

5. Click **Advanced Sharing** on the **Sharing** tab.

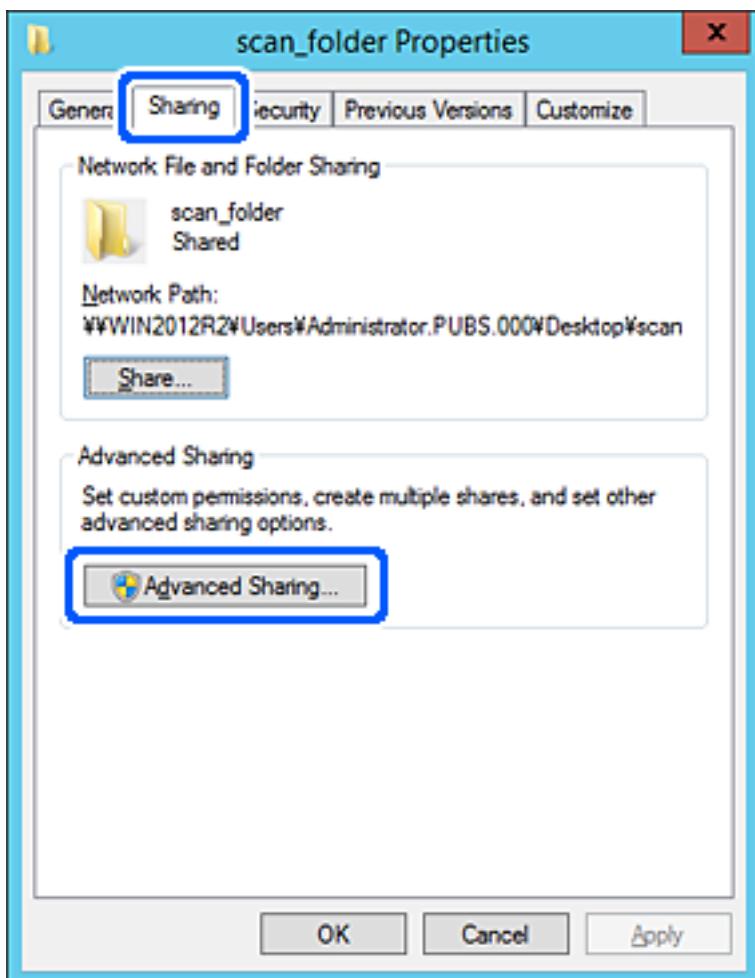

6. Select **Share this folder**, and then click **Permissions**.

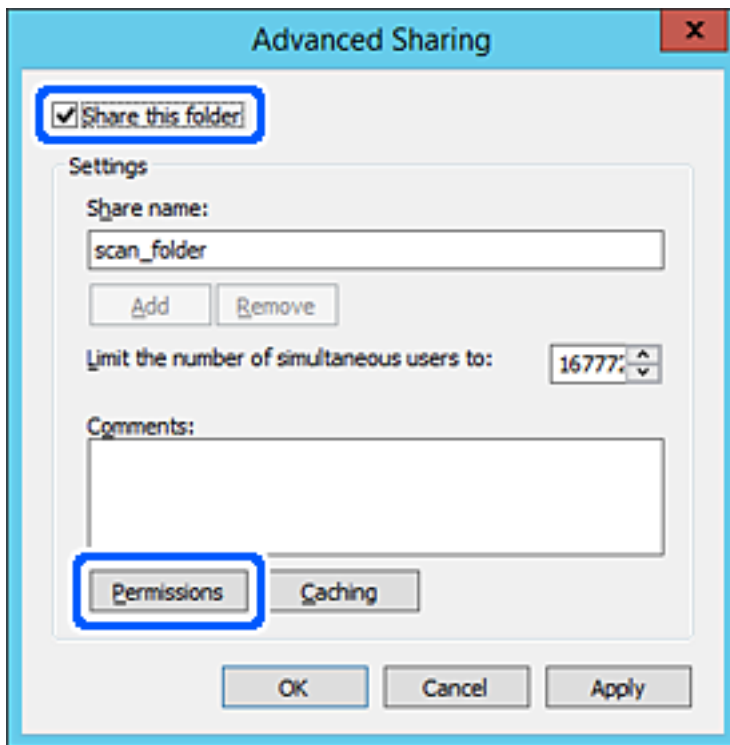

7. Select **Everyone** group of **Group or user names**, select **Allow** on **Change**, and then click **OK**.

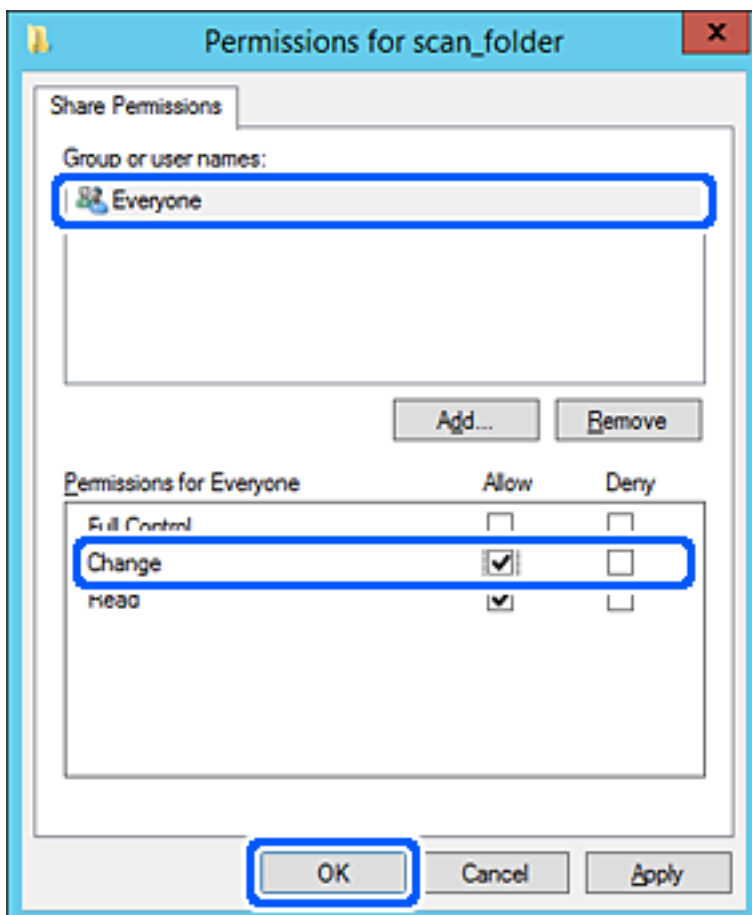

8. Click **OK**.
9. Select **Security** tab, and then select **Authenticated Users** on the **Group or user names**.

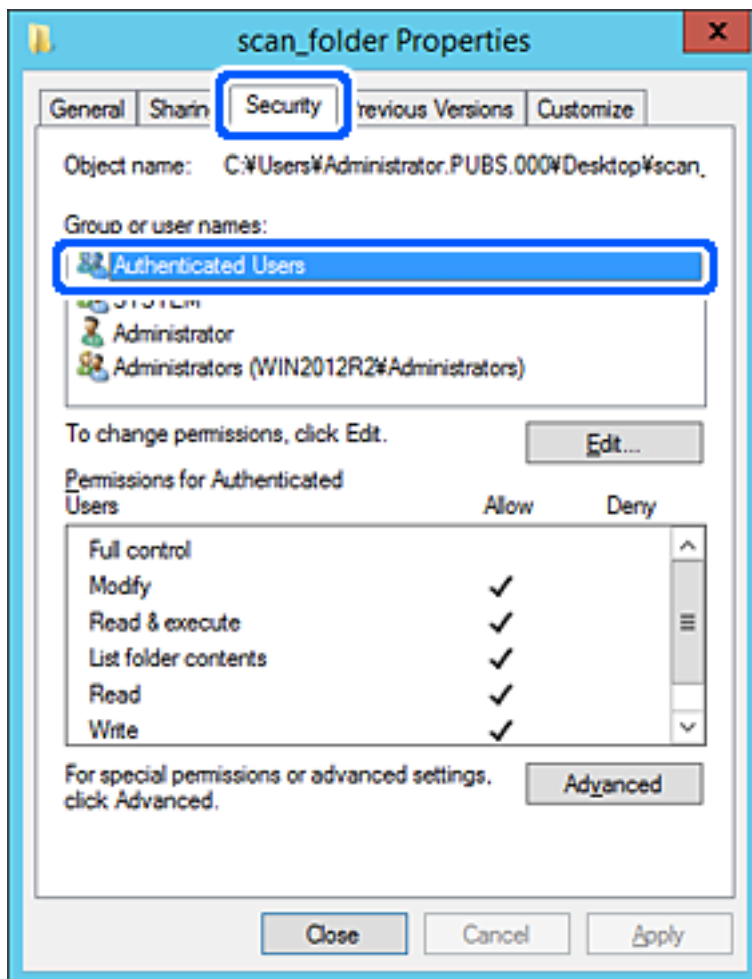

"Authenticated Users" is the special group that includes all users who can log in to the domain or computer. This group is displayed only when the folder is created just below the root folder.

If it is not displayed, you can add it by clicking **Edit**. For more details, see Related Information.

10. Check that **Allow** on **Modify** is selected in **Permissions for Authenticated Users**.

If it is not selected, select **Authenticated Users**, click **Edit**, select **Allow** on **Modify** in **Permissions for Authenticated Users**, and then click **OK**.

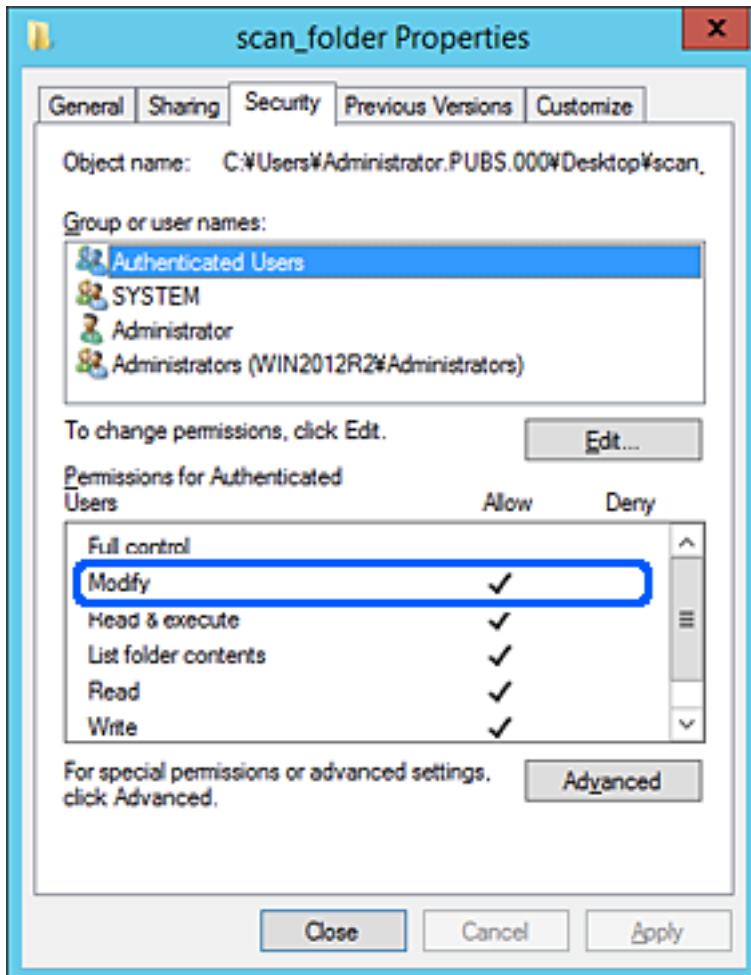

11. Select **Sharing** tab.

The network path of the shared folder is displayed. This is used when registering to the contacts of the printer. Please write it down.

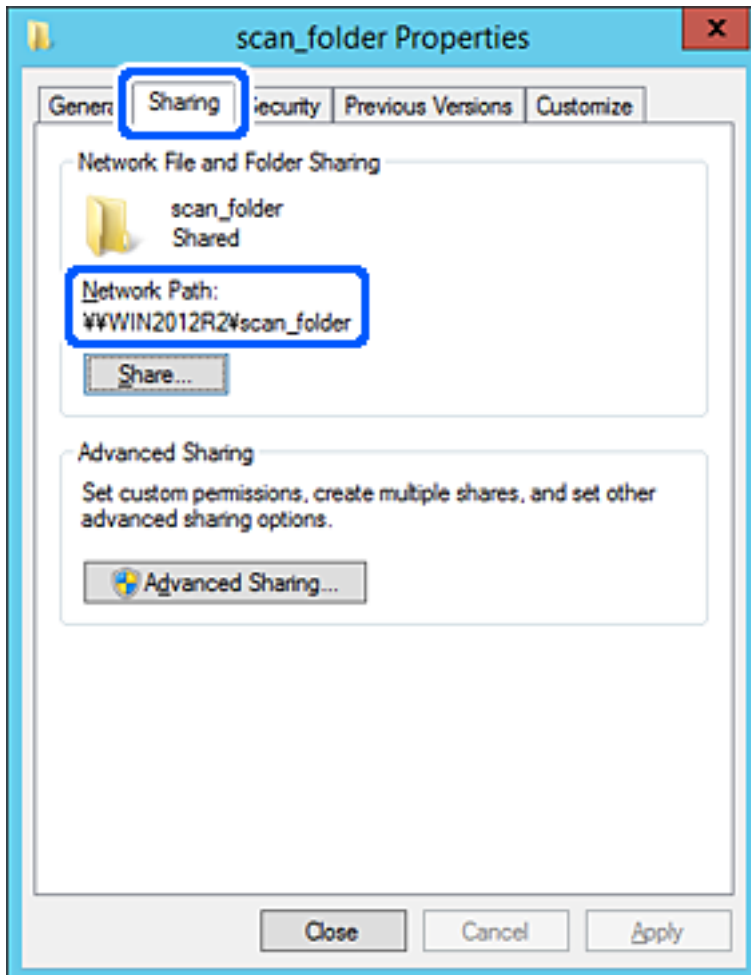

12. Click **OK** or **Close** to close the screen.

Check whether the file can be written or read on the shared folder from the computers of the same domain.

### Related Information

- ➔ [“Registering a Destination to Contacts from Web Config” on page 88](#)
- ➔ [“Adding Group or User Access Permissions” on page 81](#)

### Example of Configuration for a Personal Computer

This explanation is an example for creating the shared folder on the desktop of the user currently logging in to the computer.

The user who logs in to the computer and who has administrator authority can access the desktop folder and the document folder that are under the User folder.

Set this configuration when you **DO NOT** permit reading and writing to another user to the shared folder on a personal computer.

- Place for creating shared folder: Desktop



- Folder path: C:\Users\xxxx\Desktop\scan\_folder
- Access permission via network (Share Permissions): Everyone
- Access permission on file system (Security): do not add, or add User/Group names to permit access

1. Log in to the computer where the shared folder will be created by the administrator authority user account.
2. Start explorer.
3. Create the folder on the desktop, and then name it "scan\_folder".

For the folder name, enter between 1 and 12 alphanumeric characters. If the character limit of the folder name is exceeded, you may not be able to access it normally by the varied environment.

4. Right click the folder, and then select **Properties**.

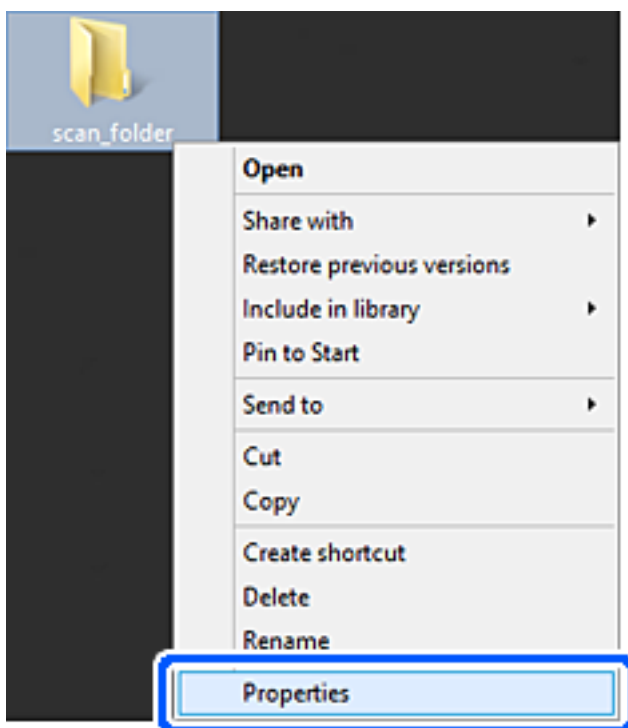

5. Click **Advanced Sharing** on the **Sharing** tab.

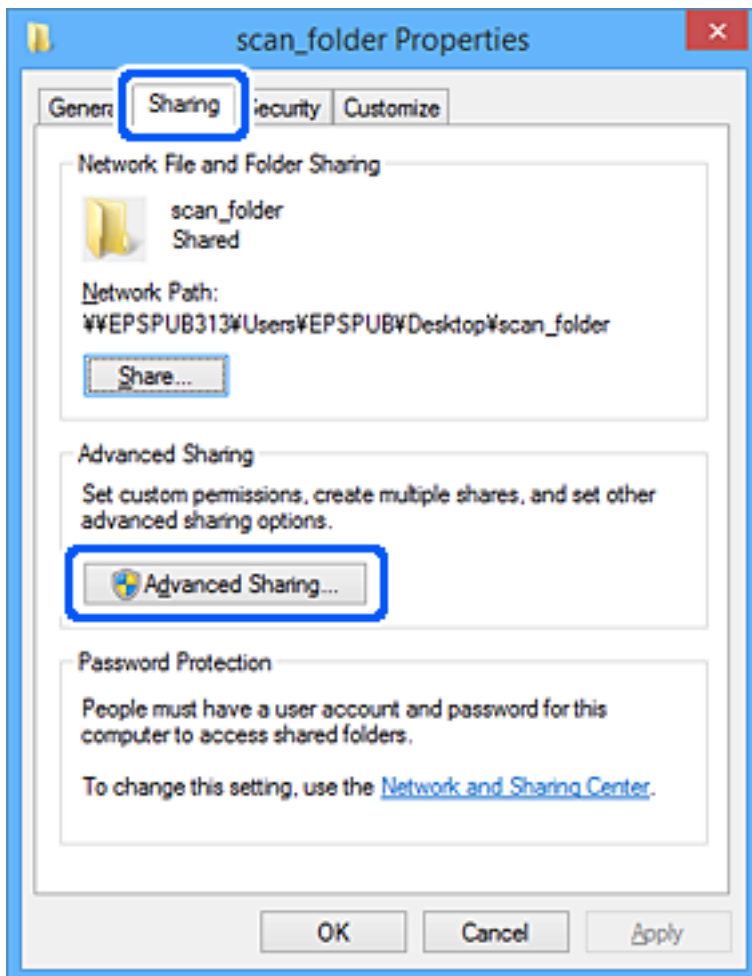

6. Select **Share this folder**, and then click **Permissions**.

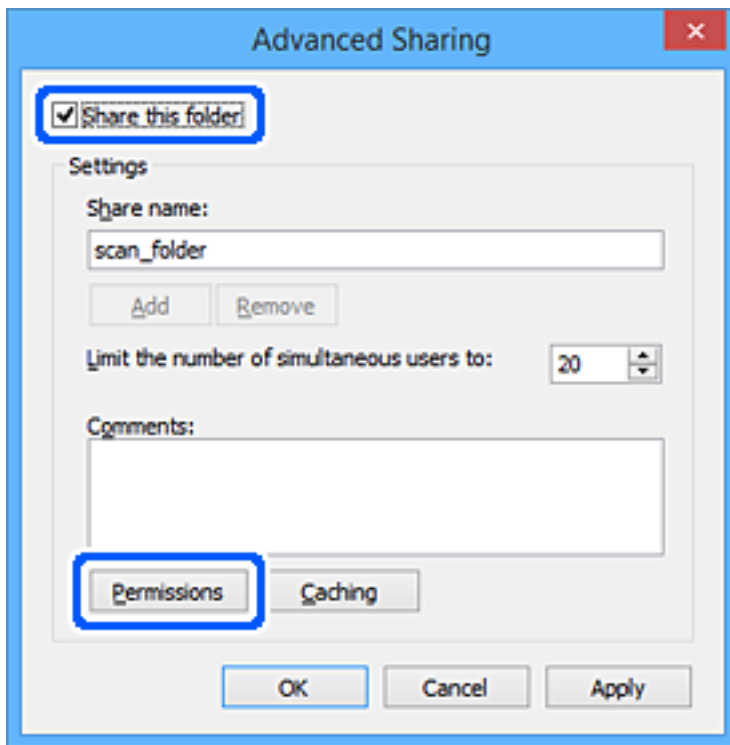

7. Select **Everyone** group of **Group or user names**, select **Allow** on **Change**, and then click **OK**.

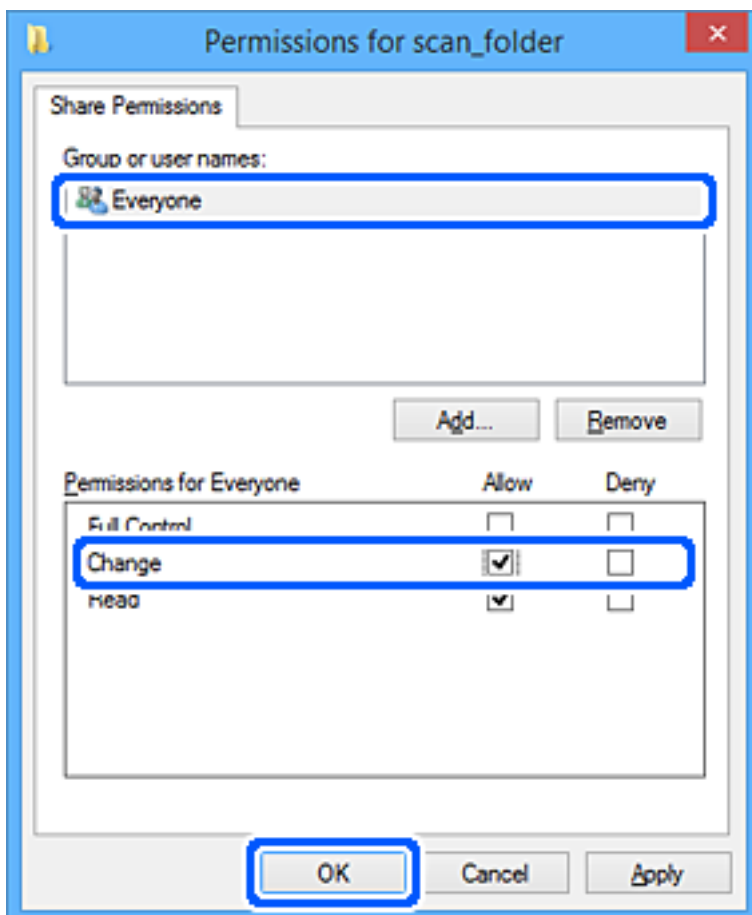

8. Click **OK**.
9. Select **Security** tab.
10. Check the group or the user in the **Group or user names**.

The group or the user that is displayed here can access the shared folder.

In this case, the user who logs in to this computer and the Administrator can access the shared folder.

Add access permission, if necessary. You can add it by clicking **Edit**. For more details, see Related Information.

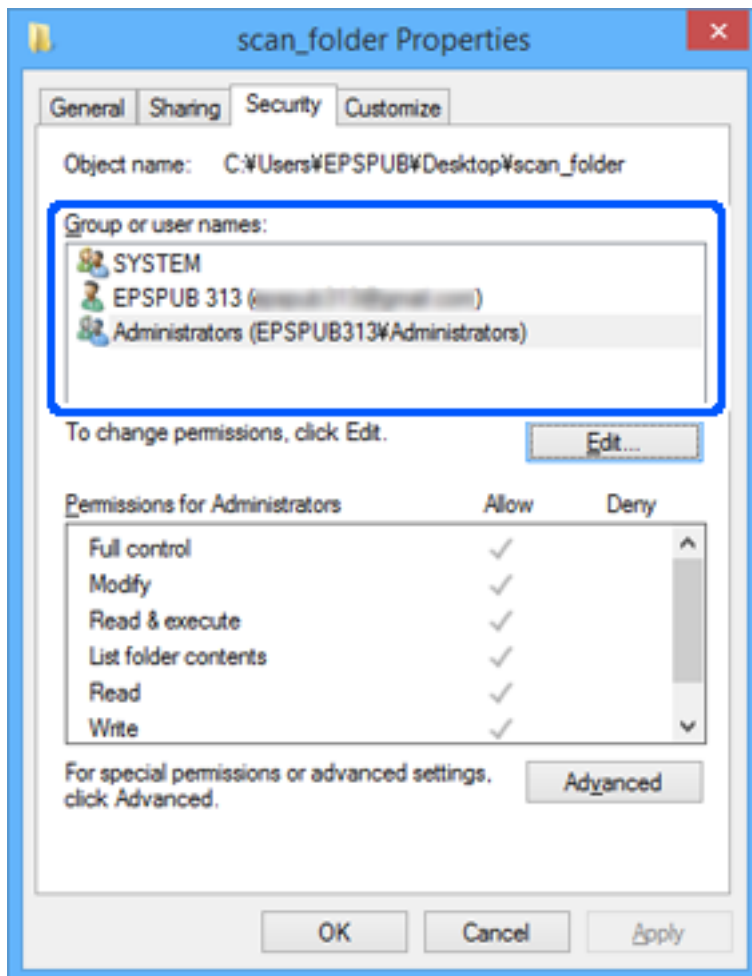

11. Select **Sharing** tab.

The network path of the shared folder is displayed. This is used when registering to the contacts of the printer. Please write it down.

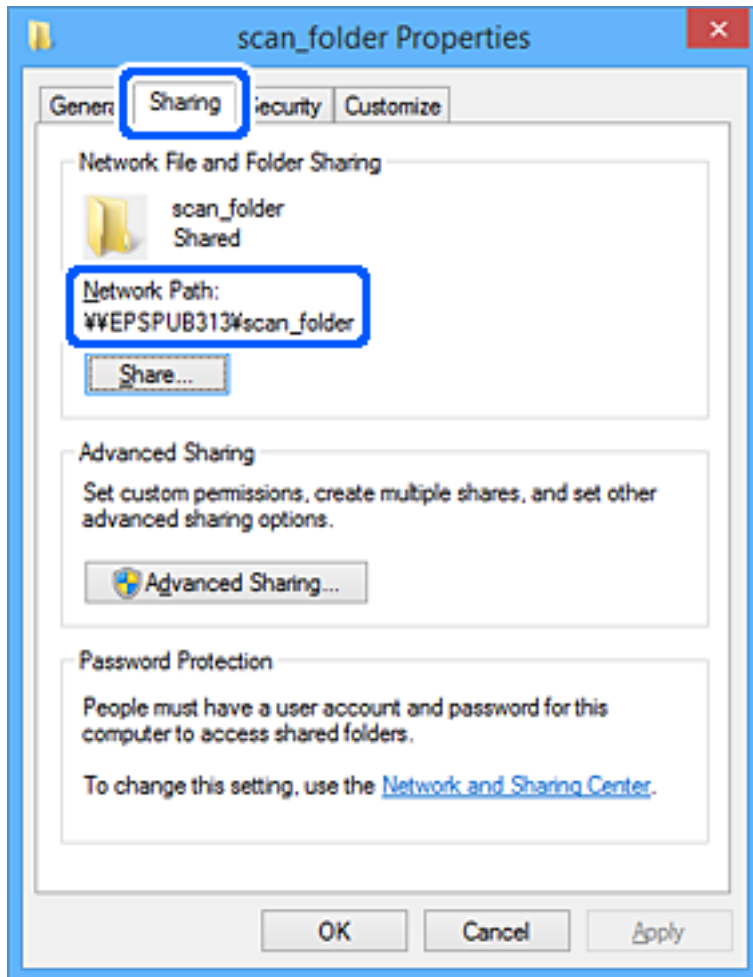

12. Click **OK** or **Close** to close the screen.

Check whether the file can be written or read on the shared folder from the computers of users or groups with access permission.

### Related Information

- ➔ “Registering a Destination to Contacts from Web Config” on page 88
- ➔ “Adding Group or User Access Permissions” on page 81

### Adding Group or User Access Permissions

You can add the group or user access permissions.

1. Right click the folder and select **Properties**.
2. Select **Security** tab.

3. Click **Edit**.

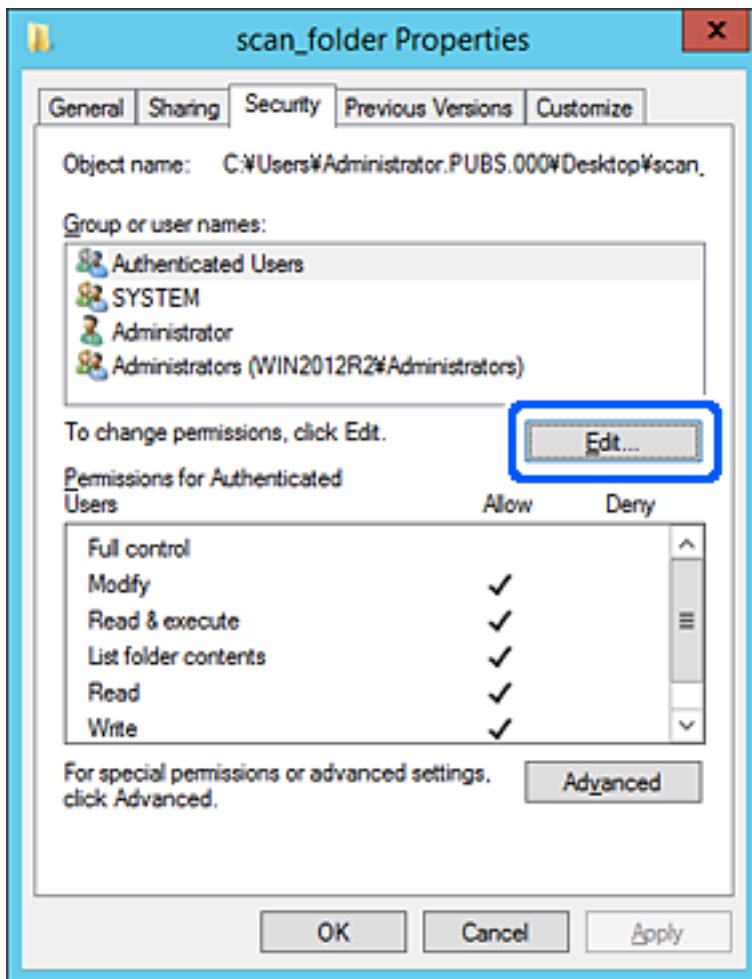

- Click **Add** under the **Group or user names**.

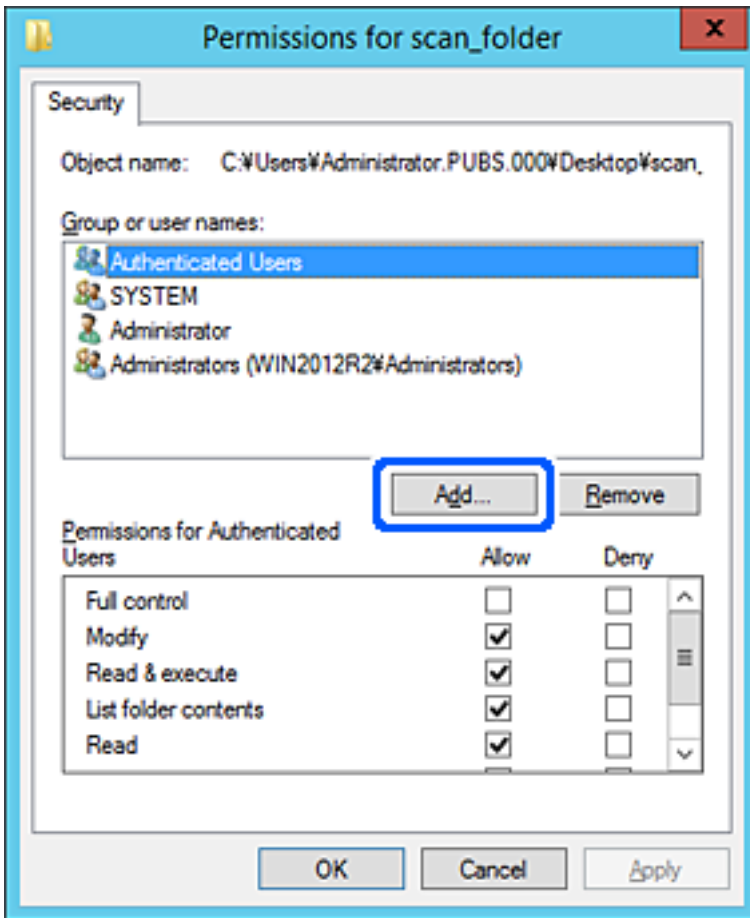

- Enter the group or user name that you want to permit access, and then click **Check Names**.

An underline is added to the name.

**Note:**

If you do not know the full name of the group or user, enter part of the name, and then click **Check Names**. The group names or user names that match part of the name are listed, and then you can select the full name from the list.

If just one name matches, the full name with underlining is displayed in **Enter the object name to select**.

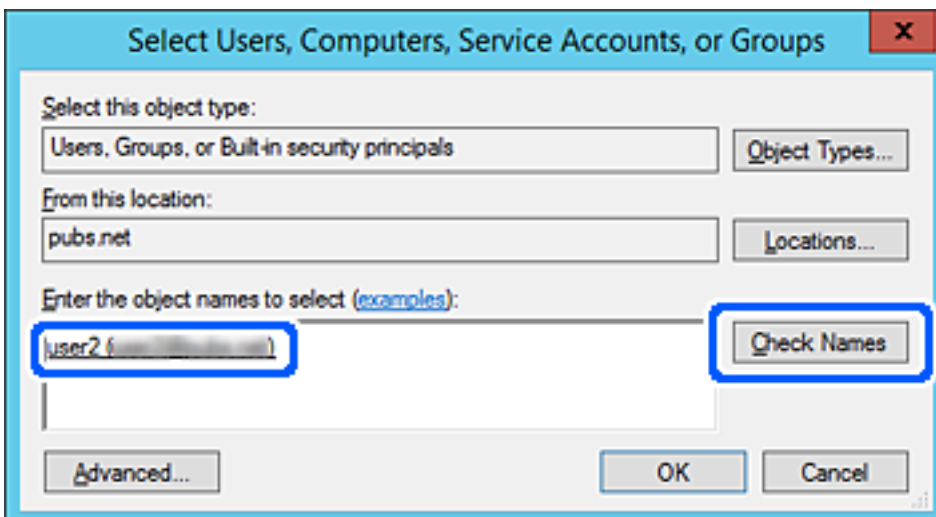

6. Click **OK**.
7. On the Permission screen, select the user name that is entered in **Group or user names** , select the access permission on **Modify**, and then click **OK**.

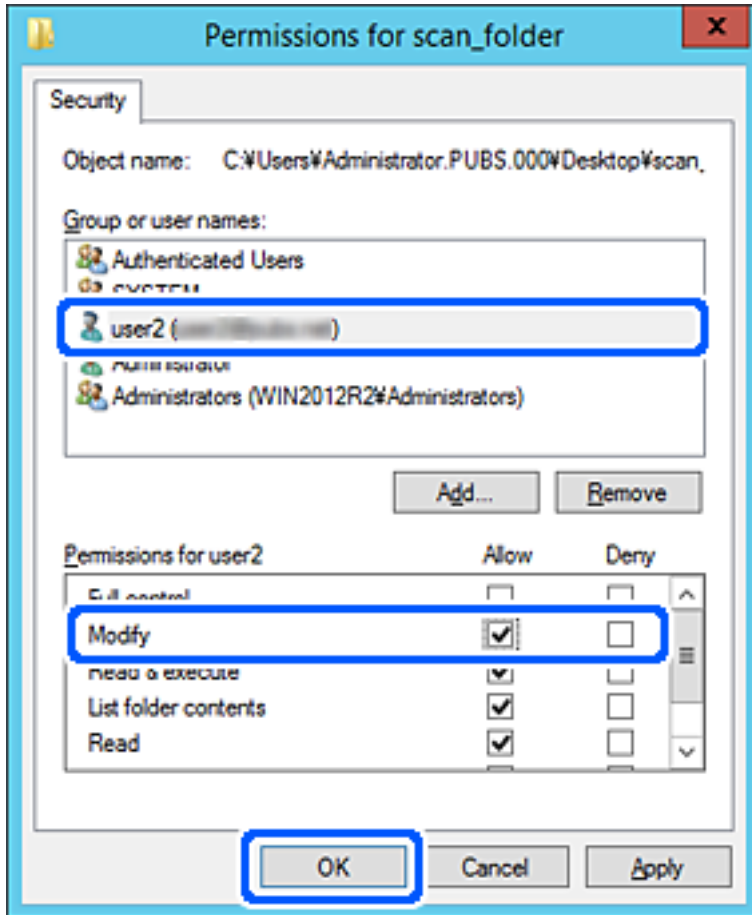

8. Click **OK** or **Close** to close the screen.

Check whether the file can be written or read on the shared folder from the computers of users or groups with access permission.

### **Using Microsoft Network Sharing**

Enable this to save a file on a shared network folder from the printer.

1. Enter the printer's IP address into a browser to access Web Config.  
Enter the printer's IP address from a computer that is connected to the same network as the printer.  
You can check the IP address of the printer from the following menu.  
**Settings > General Settings > Network Settings > Network Status > Wired LAN/Wi-Fi Status**
2. Enter the administrator password to log in as an administrator.
3. Select in the following order.  
**Network tab > MS Network**



4. Enable **Use Microsoft network sharing**.
5. Set each item if necessary.
6. Click **Next**.
7. Confirm the settings, and then click **OK**.

**Related Information**

➔ [“Default Value of the Administrator Password” on page 19](#)

## Solving Problems for a Shared Network Folder

### *Cannot Save Scanned Images to the Shared Folder*

### Messages are Displayed on the Control Panel when Scanning to a Network Folder

When error messages are displayed on the control panel, check the message itself or the following list to solve the problems.

Messages	Solutions
DNS error. Check DNS settings.	<p>Cannot connect to the computer. Check the following.</p> <ul style="list-style-type: none"> <li><input type="checkbox"/> Make sure that the address in the contacts list on the printer and the address of the shared folder are the same.</li> <li><input type="checkbox"/> If the IP address of the computer is static and is set manually, change the computer name in the network path to the IP address. Example: \\EPSON02\SCAN to \\192.168.xxx.xxx\SCAN</li> <li><input type="checkbox"/> Make sure that the computer is turned on and does not sleep. If the computer sleeps, you cannot save scanned images to the shared folder.</li> <li><input type="checkbox"/> Temporarily disable the computer's Firewall and security software. If this clears the error, check the settings in the security software.</li> <li><input type="checkbox"/> If <b>Public network</b> is selected as the network place, you cannot save the scanned images to the shared folder. Set the forward settings for each port.</li> <li><input type="checkbox"/> If you are using a laptop computer and the IP address is set as DHCP, the IP address may change when reconnecting to the network. Obtain the IP address again.</li> <li><input type="checkbox"/> Make sure the DNS setting is correct. Contact your network administrator about the DNS settings.</li> <li><input type="checkbox"/> The computer name and the IP address may differ when the management table of the DNS server is not updated. Contact your DNS server administrator.</li> </ul>
Authentication error. Check the authentication method, authenticated account, and authenticated password.	<p>Make sure the user name and the password are correct on the computer and the contacts on the printer. Also, make sure that the password has not expired.</p>

Messages	Solutions
Communication error. Check the Wi-Fi/network connection.	<p>Cannot communicate with a network folder that is registered on the contacts list. Check the following.</p> <ul style="list-style-type: none"> <li><input type="checkbox"/> Make sure that <b>Use Microsoft network sharing</b> is enabled on the Web Config. Select <b>Network &gt; MS Network</b> on the Web Config.</li> <li><input type="checkbox"/> Make sure that the address in the contacts list on the printer and the address of the shared folder are the same.</li> <li><input type="checkbox"/> Access rights for the user in the contacts list should be added on the <b>Sharing</b> tab and the <b>Security</b> tab of the shared folder's properties. Also, the permissions for the user should be set to "allowed".</li> </ul>
The file name is already in use. Rename the file and scan again.	Change the file name settings. Otherwise, move or delete the files, or change the file name on the shared folder.
Scanned file(s) are too large. Only XX page(s) have been sent. Check if the destination has enough space.	There is not enough disk space on the computer. Increase the free space on the computer.

## ■ Checking the Point where the Error Occurred

### Solutions

When saving scanned images to the shared folder, saving process proceeds as following. You can then check the point where the error occurred.

Items	Operation	Error Messages
Connecting	Connect to the computer from the printer.	DNS error. Check DNS settings.
Logging on to the computer	Log on to the computer with the user name and the password.	Authentication error. Check the authentication method, authenticated account, and authenticated password.
Checking the folder to save	Check the network path of the shared folder.	Communication error. Check the Wi-Fi/network connection.
Checking the file name	Check if there is a file with the same name as the file you want to save in the folder.	The file name is already in use. Rename the file and scan again.
Writing the file	Write a new file.	Scanned file(s) are too large. Only XX page(s) have been sent. Check if the destination has enough space.

## Saving the Scanned Images Takes a Long Time

### ■ It takes a long time for the name resolution to correspond to the "Domain Name" and the "IP Address".

#### Solutions

Check the following points.

- Make sure the DNS setting is correct.
- Make sure each DNS setting is correct when checking the Web Config.
- Make sure the DNS domain name is correct.

## Contacts Registration

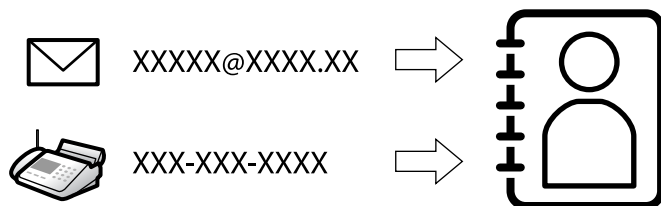

Registering destinations in the printer's contacts list allows you to easily enter the destination when scanning or sending faxes.

**Note:**

You can register the following types of destinations in the contacts list. You can register up to 200 entries in total.

Fax	Destination for fax
Email	Destination for email You need to configure the email server settings beforehand.
Network Folder (SMB)	Destination for scan data and fax forwarding data
Network Folder/FTP	

## Contacts Configuration Comparison

There are three tools for configuring the printer's contacts: Web Config, Epson Device Admin, and the printer's control panel. The differences between three tools are listed in the table below.

Features	Web Config	Epson Device Admin	Printer's control panel
Registering a destination	✓	✓	✓
Editing a destination	✓	✓	✓
Adding a group	✓	✓	✓
Editing a group	✓	✓	✓
Deleting a destination or groups	✓	✓	✓
Deleting all destinations	✓	✓	-
Importing a file	✓	✓	-
Exporting to a file	✓	✓	-
Assigning destinations to frequent use	✓	✓	✓
Sorting destinations assigned to frequent use	-	-	✓

**Note:**

You can also configure the fax destination using the FAX Utility.

## Registering Destinations to Contacts

You can register up to 200 destinations to the contacts list in total.

### **Registering a Destination to Contacts from Web Config**

1. Enter the printer's IP address into a browser to access Web Config.  
Enter the printer's IP address from a computer that is connected to the same network as the printer.  
You can check the IP address of the printer from the following menu.  
**Settings > General Settings > Network Settings > Network Status > Wired LAN/Wi-Fi Status**
2. Enter the administrator password to log in as an administrator.
3. Select in the following order.  
**Scan/Copy or Fax tab > Contacts**
4. Select the number that you want to register, and then click **Edit**.
5. Enter **Name** and **Index Word**.
6. Select the destination type as the **Type** option.  
*Note:*  
*You cannot change the **Type** option after registration is complete. If you want to change the type, delete the destination and then register again.*
7. Enter a value for each item, and then click **Apply**.

### **Related Information**

- ➔ [“Scanning Originals to a Network Folder” on page 208](#)
- ➔ [“Scanning Originals to an Email” on page 210](#)
- ➔ [“Default Value of the Administrator Password” on page 19](#)

## Destination Setting Items

Items	Settings and Explanation
<b>Common Settings</b>	
Name	Enter a name displayed in the contacts in 30 characters or less in Unicode (UTF-8). If you do not specify this, leave it blank.
Index Word	Enter words to search in 30 characters or less in Unicode (UTF-8). If you do not specify this, leave it blank.
Type	Select the type of the address that you want to register.
Assign to Frequent Use	Select to set the registered address as a frequently used address.  When setting as a frequently used address, it is displayed on the top screen of fax and scan, and you can specify the destination without displaying the contacts.
<b>Fax</b>	
Fax Number	Enter between 1 and 64 characters using 0-9 - * # and space.
Fax Speed	Select a communication speed for a destination.
Subaddress (SUB/SEP)	Set the sub address that is appended when fax is sent. Enter within 20 characters or less using 0-9, *, # or spaces. If you do not specify this, leave it blank.
Password (SID/PWD)	Set the password for the sub address. Enter within 20 characters or less using 0-9, *, # or spaces. If you do not specify this, leave it blank.
<b>Email</b>	
Email Address	Enter between 1 and 255 characters using A-Z a-z 0-9 ! # \$ % & ' * + - . / = ? ^ _ {   } ~ @.
<b>Network Folder (SMB)</b>	
Save to	\\“Folder path”  Enter the location where the target folder is located between 1 and 253 characters in Unicode (UTF-8), omitting “\\”.

Items	Settings and Explanation
User Name	Enter a user name to access a network folder in 30 characters or less in Unicode (UTF-8). However, avoid using control characters (0x00 to 0x1f, 0x7F).
Password	Enter a password to access a network folder in 20 characters or less in Unicode (UTF-8). However, avoid using control characters (0x00 to 0x1f, 0x7F).
FTP	
Secure Connection	Select FTP or FTPS according to the file transfer protocol the FTP server supports. Select <b>FTPS</b> to allow the printer to communicate with security measures.
Save to	Enter the server address between 1 and 253 characters in Unicode (UTF-16) omitting "ftp://" or "ftps://". However, avoid using control characters (0x0000 to 0x001f, 0x007F).
User Name	Enter a user name to access an FTP server in 30 characters or less in Unicode (UTF-8). However, avoid using control characters (0x00 to 0x1f, 0x7F). If the server allows anonymous connections, enter a user name such as Anonymous and FTP. If you do not specify this, leave it blank.
Password	Enter a password to access to an FTP server within 20 characters or less in Unicode (UTF-8). However, avoid using control characters (0x00 to 0x1f, 0x7F). If you do not specify this, leave it blank.
Connection Mode	Select the connection mode from the menu. If a firewall is set between the printer and the FTP server, select <b>Passive Mode</b> .
Port Number	Enter the FTP server port number between 1 and 65535.
Certificate Validation	The FTP server's certificate is validated when this is enabled. This is available when <b>FTPS</b> is selected for <b>Secure Connection</b> .  To set up, you need to import the CA Certificate to the printer.
SharePoint(WebDAV)	
Secure Connection	Select HTTP or HTTPS according to the hyper-text transfer protocol the HTTP server supports. Select <b>HTTPS</b> to allow the printer to communicate with security measures.
Save to	Enter the server address between 1 and 253 characters in Unicode (UTF-16) omitting "http://" or "https://". However, avoid using control characters (0x0000 to 0x001f, 0x007F).
User Name	Enter a user name to access an HTTP server in 30 characters or less in Unicode (UTF-8). However, avoid using control characters (0x00 to 0x1f, 0x7F). If the server allows anonymous connections, enter a user name such as Anonymous. If you do not specify this, leave it blank.
Password	Enter a password to access to an HTTP server within 20 characters or less in Unicode (UTF-8). However, avoid using control characters (0x00 to 0x1f, 0x7F). If you do not specify this, leave it blank.
Certificate Validation	The HTTP server's certificate is validated when this is enabled. This is available when <b>HTTPS</b> is selected for <b>Secure Connection</b> .  To set up, you need to import the CA Certificate to the printer.
Proxy Server	Select whether or not to use a proxy server to access an HTTP server.

### **Registering a Destination to Contacts from the Printer's Control Panel**

1. Select the menus on the printer's control panel as described below.

**Settings > Contacts Manager**

2. Select **Add/Edit/Delete**.

3. Do one of the following..

To register a new contact, select **Add Entry**, select **Add Contact**.

To edit a contact, select **>** on the target contact, and then select **Edit**.

To delete a contact, select **>** on the target contact, and then select **Delete**, and then select **Yes**. You do not have to perform following procedures.

4. Select the destination type as the **Type** option.

**Note:**

*You cannot change the **Type** option after registration is complete. If you want to change the type, delete the destination and then register again.*

5. Select the number that you want to register as **Registry Number**

6. Enter **Name** and **Index Word**.

7. Enter a value for each remaining item.

8. Select **OK** to apply the settings.

#### **Related Information**

➔ [“Scanning Originals to a Network Folder” on page 208](#)

➔ [“Scanning Originals to an Email” on page 210](#)

### **Registering Destinations as a Group**

If the destination type is set to **Fax** or **Email**, you can register the destinations as a group.

You can register up to 200 destinations and groups to the contacts list in total.

#### **Registering Destinations as a Group from Web Config**

1. Enter the printer's IP address into a browser to access Web Config.

Enter the printer's IP address from a computer that is connected to the same network as the printer.

You can check the IP address of the printer from the following menu.

**Settings > General Settings > Network Settings > Network Status > Wired LAN/Wi-Fi Status**

2. Enter the administrator password to log in as an administrator.

3. Select in the following order.

**Scan/Copy or Fax tab > Contacts**

4. Select the number that you want to register, and then click **Edit**.
5. Select a group from **Type**.
6. Click **Select** for **Contact(s) for Group**.  
The available destinations are displayed.
7. Select the destination that you want to register to the group, and then click **Select**.

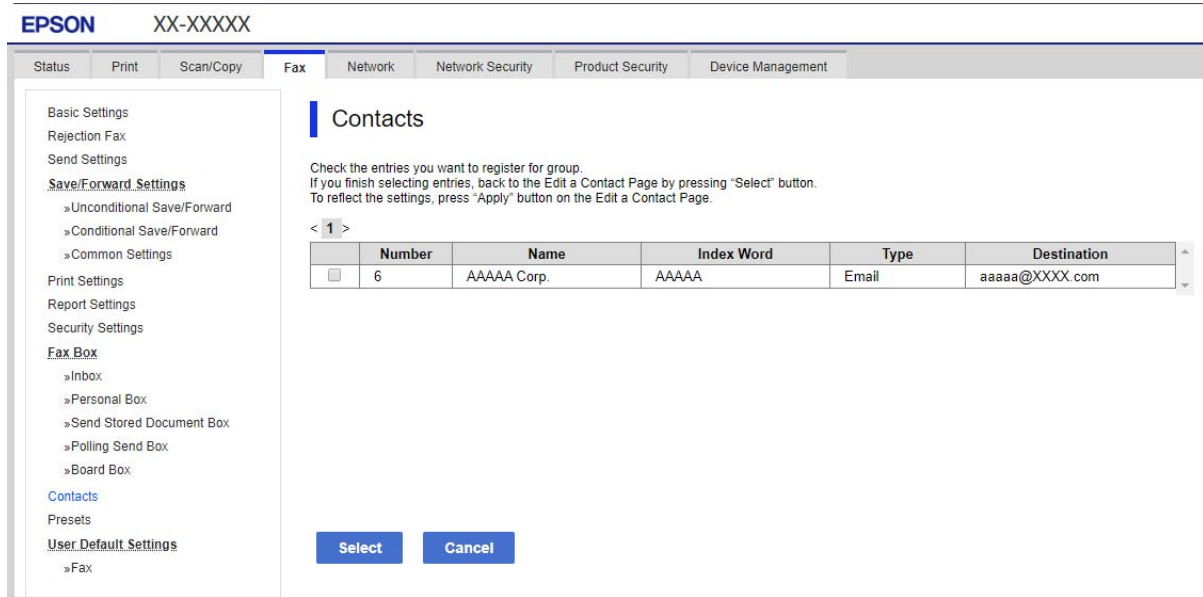

8. Enter a **Name** and **Index Word**.
9. Select whether or not you assign the registered group to the frequently used group.  
**Note:**  
*Destinations can be registered to multiple groups.*
10. Click **Apply**.

### Related Information

➔ [“Default Value of the Administrator Password” on page 19](#)

### **Registering Destinations as a Group from the Printer's Control Panel**

1. Select the menus on the printer's control panel as described below.  
**Settings > Contacts Manager**
2. Select **Add/Edit/Delete**.
3. Select **Add Entry**, select **Add Group**.



4. Select the destination type as the **Type** option.

**Note:**

*You cannot change the **Type** option after registration is complete. If you want to change the type, delete the destination and then register again.*

5. Select the number that you want to register as the **Registry Number**.
6. Enter the **Group Name (Required)** and **Index Word**.
7. Select **Contact(s) Added to the Group (Required)**, select the contacts you want add, and then select **Close**.
8. Select **OK** to apply the settings.

## **Registering Frequently Used Contacts (Assign to Frequent Use)**

### **Registering Frequently Used Contacts from Web Config**

1. Enter the printer's IP address into a browser to access Web Config.  
Enter the printer's IP address from a computer that is connected to the same network as the printer.  
You can check the IP address of the printer from the following menu.  
**Settings > General Settings > Network Settings > Network Status > Wired LAN/Wi-Fi Status**
2. Enter the administrator password to log in as an administrator.
3. Select in the following order.  
**Scan/Copy or Fax tab > Contacts**
4. Select the number that you want to register, and then click **Edit**.
5. Select **ON** in **Assign to Frequent Use**.  
You cannot edit the order of the contacts from the Web Config screen.
6. Click **Apply**

### **Related Information**

➡ [“Default Value of the Administrator Password” on page 19](#)

### **Registering Frequently Used Contacts from Printer's Control Panel**

1. Tap **Settings** on the home screen.
2. Tap **Contacts Manager > Frequent**.
3. Select the type of contact that you want to register.
4. Tap **Edit**.
5. Select frequently used contacts that you want to register, and then tap **OK**. To cancel the selection, tap it again.

6. Tap **Close**.

## Exporting and Importing Contacts

Using Web Config or other tools, you can back up and import contacts.

### For Web Config

- You can back up contacts by exporting the printer settings that include contacts. The exported file cannot be edited because it is exported as a binary file.
- When importing the printer settings to the printer, contacts are overwritten.

### For Epson Device Admin

- Only contacts can be exported from the device's property screen.
- If you do not export the security-related items, you can edit the exported contacts and import them because this can be saved as a SYLK file or csv file.
- You can import your contacts to multiple printers in bulk. This is useful when you are replacing your printers and want to transfer the contacts from the old printers to the new printers.  
For more information, see the documentation or help of Epson Device Admin

## Exporting and Importing Contacts Using Web Config

### Related Information

- ➔ [“Default Value of the Administrator Password” on page 19](#)

### Importing Contacts Using Web Config

If you have a printer that allows you to backup contacts and is compatible with this printer, you can register contacts easily by importing the backup file.

#### **Note:**

*For instructions on how to back up contacts compatible with this printer, see the documentation provided with the printer that has a compatible contacts list with this printer.*

Follow the steps below to import the contacts to this printer.

1. Enter the printer's IP address into a browser to access Web Config.  
Enter the printer's IP address from a computer that is connected to the same network as the printer.  
You can check the IP address of the printer from the following menu.  
**Settings > General Settings > Network Settings > Network Status > Wired LAN/Wi-Fi Status**
2. Enter the administrator password to log in as an administrator.
3. Select in the following order.  
**Device Management > Export and Import Setting Value > Import**
4. Select the backup file you created in **File**, enter the password, and then click **Next**.
5. Select the **Contacts** checkbox, and then click **Next**.

### Related Information

➔ [“Default Value of the Administrator Password” on page 19](#)

### Exporting Contacts Using Web Config

Contacts data may be lost due to a printer malfunction. We recommend that you make a backup of the data whenever you update the data. Epson shall not be responsible for the loss of any data, for backing up or recovering data and/or settings even during a warranty period.

Using Web Config, you can back up the contact data stored in the printer to the computer.

1. Enter the printer's IP address into a browser to access Web Config.  
Enter the printer's IP address from a computer that is connected to the same network as the printer.  
You can check the IP address of the printer from the following menu.  
**Settings > General Settings > Network Settings > Network Status > Wired LAN/Wi-Fi Status**
2. Enter the administrator password to log in as an administrator.
3. Select in the following order.  
**Device Management** tab > **Export and Import Setting Value > Export**
4. Select one of the **Contacts** checkboxes.  
For example, if you select **Contacts** under the **Scan/Copy** category, the same checkbox under the Fax category is also selected.
5. Enter a password to encrypt the exported file.  
You need the password to import the file. Leave this blank if you do not want to encrypt the file.
6. Click **Export**.

### Related Information

➔ [“Default Value of the Administrator Password” on page 19](#)

### *Exporting and Importing Contacts Using Epson Device Admin*

#### Exporting Contacts Using Epson Device Admin

Save the contacts information to the file.

You can edit files saved in SYLK format or csv format by using a spreadsheet application or text editor. You can register all at once after deleting or adding the information.

Information that includes security items such as password and personal information can be saved in binary format with a password. You cannot edit the file. This can be used as the backup file of the information including the security items.

1. Start Epson Device Admin.
2. Select **Devices** on the side bar task menu.

3. Select the device you want to configure from the device list.
4. Click **Device Configuration** on the **Home** tab on the ribbon menu.  
When the administrator password has been set, enter the password and click **OK**.
5. Click **Common > Contacts**.
6. Select the export format from **Export > Export items**.
  - All Items  
Export the encrypted binary file. Select when you want to include the security items such as password and personal information. You cannot edit the file. If you select it, you have to set the password. Click **Configuration** and set a password between 8 and 63 characters long in ASCII. This password is required when importing the binary file.
  - Items except Security Information  
Export the SYLK format or csv format files. Select when you want to edit the information of the exported file.
7. Click **Export**.
8. Specify the place to save the file, select the file type, and then click **Save**.  
The completion message is displayed.
9. Click **OK**.  
Check that the file is saved to the specified place.

### Related Information

➔ [“Software for Managing Devices on the Network \(Epson Device Admin\)” on page 357](#)

### Importing Contacts Using Epson Device Admin

Import the contacts information from the file.

You can import the files saved in SYLK format or csv format or the backed-up binary file that includes the security items.

1. Start Epson Device Admin.
2. Select **Devices** on the side bar task menu.
3. Select the device you want to configure from the device list.
4. Click **Device Configuration** on the **Home** tab on the ribbon menu.  
When the administrator password has been set, enter the password and click **OK**.
5. Click **Common > Contacts**.
6. Click **Browse** on **Import**.
7. Select the file you want to import and then click **Open**.  
When you select the binary file, in **Password** enter the password you set when exporting the file.

8. Click **Import**.

The confirmation screen is displayed.

9. Click **OK**.

The validation result is displayed.

Edit the information read

Click when you want to edit the information individually.

Read more file

Click when you want to import multiple files.

10. Click **Import**, and then click **OK** on the import completion screen.

Return to the device's property screen.

11. Click **Transmit**.

12. Click **OK** on the confirmation message.

The settings are sent to the printer.

13. On the sending completion screen, click **OK**.

The printer's information is updated.

Open the contacts from Web Config or printer's control panel, and then check that the contact is updated.

### Related Information

➔ [“Software for Managing Devices on the Network \(Epson Device Admin\)” on page 357](#)

## Settings to use Your Cloud Service as Forwarding Fax Destinations

By using the Epson Connect service available on the internet, you can forward received faxes to your cloud accounts.

To use this service, you need to register the user, the printer, and your cloud destinations in **Epson Connect**, and then register the destinations in the printer.

See the Epson Connect web portal for details on how to setup and register your Cloud Account

<https://www.epsonconnect.com/>

## Registering a Cloud Destination in the Printer from Web Config

1. Enter the printer's IP address into a browser to access Web Config.

Enter the printer's IP address from a computer that is connected to the same network as the printer.

You can check the IP address of the printer from the following menu.

**Settings > General Settings > Network Settings > Network Status > Wired LAN/Wi-Fi Status**

2. Enter the administrator password to log in as an administrator.

3. Select in the following order.  
**Fax tab > Cloud Destination List**
4. Select the number that you want to register, and then click **Edit**.
5. Select the destination you want to register to the cloud destination list.

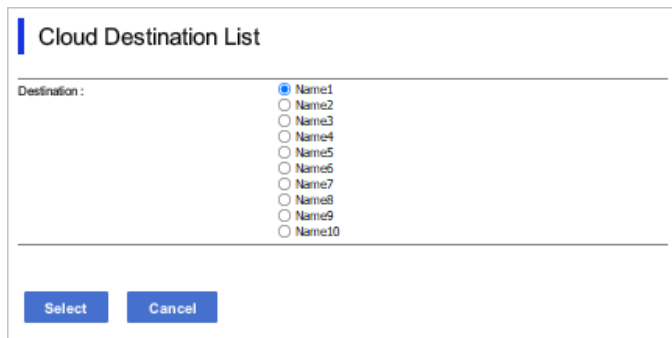

Cloud Destination List

Destination :

- Name1
- Name2
- Name3
- Name4
- Name5
- Name6
- Name7
- Name8
- Name9
- Name10

Select Cancel

6. Click **Select**.  
The setting is reflected on the printer.

## Settings to Use Users Information on the LDAP Server as Destinations

By linking the LDAP server and the printer in advance, you can search for user information registered in the LDAP server, and use the information directly as destinations for faxes or emails.

### Configuring the LDAP Server

To use the LDAP server information, register it on the printer.

1. Enter the printer's IP address into a browser to access Web Config.  
Enter the printer's IP address from a computer that is connected to the same network as the printer.  
You can check the IP address of the printer from the following menu.  
**Settings > General Settings > Network Settings > Network Status > Wired LAN/Wi-Fi Status**
2. Enter the administrator password to log in as an administrator.
3. Select in the following order.  
**Network tab > LDAP Server > Basic**
4. Enter a value for each item.
5. Select **OK**.  
The settings you have selected are displayed.

**Related Information**

➔ “Default Value of the Administrator Password” on page 19

**LDAP Server Setting Items**

Items	Settings and Explanation
Use LDAP Server	Select <b>Use</b> or <b>Do Not Use</b> .
LDAP Server Address	Enter the address of the LDAP server. Enter between 1 and 255 characters of either IPv4, IPv6, or FQDN format. For the FQDN format, you can use alphanumeric characters in ASCII (0x20-0x7E) and "- " except for the beginning and end of the address.
LDAP server Port Number	Enter the LDAP server port number between 1 and 65535.
Secure Connection	Specify the authentication method when the printer accesses the LDAP server.
Certificate Validation	When this is enabled, the certificate of the LDAP sever is validated. We recommend this is set to <b>Enable</b> . To set up, the <b>CA Certificate</b> needs to be imported to the printer.
Search Timeout (sec)	Set the length of time for searching before timeout occurs between 5 and 300.
Authentication Method	Select one of the methods. If you select <b>Kerberos Authentication</b> , select <b>Kerberos Settings</b> to make settings for Kerberos. To perform Kerberos Authentication, the following environment is required. <input type="checkbox"/> The printer and the DNS server can communicate. <input type="checkbox"/> The time of the printer, KDC server, and the server that is required for authentication (LDAP server, SMTP server, File server) are synchronized. <input type="checkbox"/> When the service server is assigned as the IP address, the FQDN of the service server is registered on the DNS server reverse lookup zone.
Kerberos Realm to be Used	If you select <b>Kerberos Authentication</b> for <b>Authentication Method</b> , select the Kerberos realm that you want to use.
Administrator DN / User Name	Enter the user name for the LDAP server in 128 characters or less in Unicode (UTF-8). You cannot use control characters, such as 0x00-0x1F and 0X7F. This setting is not used when <b>Anonymous Authentication</b> is selected as the <b>Authentication Method</b> . If you do not specify this, leave it blank.
Password	Enter the password for the LDAP server authentication in 128 characters or less in Unicode (UTF-8). You cannot use control characters, such as 0x00-0x1F and 0X7F. This setting is not used when <b>Anonymous Authentication</b> is selected as the <b>Authentication Method</b> . If you do not specify this, leave it blank.

**Kerberos Settings**

If you select **Kerberos Authentication** for **Authentication Method** of **LDAP Server > Basic**, make the following Kerberos settings from the **Network** tab > **Kerberos Settings**. You can register up to 10 settings for the Kerberos settings.

Items	Settings and Explanation
Realm (Domain)	Enter the realm of the Kerberos authentication in 255 characters or less in ASCII (0x20-0x7E). If you do not register this, leave it blank.
KDC Address	Enter the address of the Kerberos authentication server. Enter 255 characters or less in either IPv4, IPv6 or FQDN format. If you do not register this, leave it blank.
Port Number (Kerberos)	Enter the Kerberos server port number between 1 and 65535.

## Configuring the LDAP Server Search Settings

When you set up the search settings, you can use the email address and fax number registered to the LDAP server.

- Enter the printer's IP address into a browser to access Web Config.  
Enter the printer's IP address from a computer that is connected to the same network as the printer.  
You can check the IP address of the printer from the following menu.  
**Settings > General Settings > Network Settings > Network Status > Wired LAN/Wi-Fi Status**
- Enter the administrator password to log in as an administrator.
- Select in the following order.  
**Network tab > LDAP Server > Search Settings**
- Enter a value for each item.
- Click **OK** to display the setting result.  
The settings you have selected are displayed.

### Related Information

➔ [“Default Value of the Administrator Password” on page 19](#)

### LDAP Server Search Setting Items

Items	Settings and Explanation
Search Base (Distinguished Name)	If you want to search an arbitrary domain, specify the domain name of the LDAP server. Enter between 0 and 128 characters in Unicode (UTF-8). If you do not search for arbitrary attribute, leave this blank.  Example for the local server directory: dc=server,dc=local
Number of search entries	Specify the number of search entries between 5 and 500. The specified number of the search entries is saved and displayed temporarily. Even if the number of the search entries is over the specified number and an error message appears, the search can be completed.
User name Attribute	Specify the attribute name to display when searching for user names. Enter between 1 and 255 characters in Unicode (UTF-8). The first character should be a-z or A-Z.  Example: cn, uid



Items	Settings and Explanation
User name Display Attribute	Specify the attribute name to display as the user name. Enter between 0 and 255 characters in Unicode (UTF-8). The first character should be a-z or A-Z.  Example: cn, sn
Fax Number Attribute	Specify the attribute name to display when searching for fax numbers. Enter a combination of between 1 and 255 characters using A-Z, a-z, 0-9, and -. The first character should be a-z or A-Z.  Example: facsimileTelephoneNumber
Email Address Attribute	Specify the attribute name to display when searching for email addresses. Enter a combination of between 1 and 255 characters using A-Z, a-z, 0-9, and -. The first character should be a-z or A-Z.  Example: mail
Arbitrary Attribute 1 - Arbitrary Attribute 4	You can specify other arbitrary attributes to search for. Enter between 0 and 255 characters in Unicode (UTF-8). The first character should be a-z or A-Z. If you do not want to search for arbitrary attributes, leave this blank.  Example: o, ou

## Checking the LDAP Server Connection

Performs the connection test to the LDAP server by using the parameter set on **LDAP Server > Search Settings**.

1. Enter the printer's IP address into a browser to access Web Config.  
Enter the printer's IP address from a computer that is connected to the same network as the printer.  
You can check the IP address of the printer from the following menu.  
**Settings > General Settings > Network Settings > Network Status > Wired LAN/Wi-Fi Status**
2. Enter the administrator password to log in as an administrator.
3. Select in the following order.  
**Network tab > LDAP Server > Connection Test**
4. Select **Start**.  
The connection test is started. After the test, the check report is displayed.

### Related Information

➔ [“Default Value of the Administrator Password” on page 19](#)

### LDAP Server Connection Test References

Messages	Explanation
Connection test was successful.	This message appears when the connection with the server is successful.

Messages	Explanation
<p>Connection test failed.</p> <p>Check the settings.</p>	<p>This message appears for the following reasons:</p> <ul style="list-style-type: none"> <li><input type="checkbox"/> The LDAP server address or the port number is incorrect.</li> <li><input type="checkbox"/> A timeout has occurred.</li> <li><input type="checkbox"/> <b>Do Not Use</b> is selected as the <b>Use LDAP Server</b>.</li> <li><input type="checkbox"/> If <b>Kerberos Authentication</b> is selected as the <b>Authentication Method</b>, settings such as <b>Realm (Domain)</b>, <b>KDC Address</b> and <b>Port Number (Kerberos)</b> are incorrect.</li> </ul>
<p>Connection test failed.</p> <p>Check the date and time on your product or server.</p>	<p>This message appears when the connection fails because the time settings for the printer and the LDAP server are mismatched.</p>
<p>Authentication failed.</p> <p>Check the settings.</p>	<p>This message appears for the following reasons:</p> <ul style="list-style-type: none"> <li><input type="checkbox"/> <b>User Name</b> and/or <b>Password</b> is incorrect.</li> <li><input type="checkbox"/> If <b>Kerberos Authentication</b> is selected as the <b>Authentication Method</b>, the time/date may not be configured.</li> </ul>
<p>Cannot access the printer until processing is complete.</p>	<p>This message appears when the printer is busy.</p>

## Sending Faxes Using a Fax Server

You can send faxes using a fax server on your network. Configuring the fax server allows you to send an email to the fax server with the fax data attached, and then send it using your printer's fax function. The fax server sends the fax using the recipient's fax number included in the e-mail address. When fax server settings are enabled, you cannot send faxes using LINE port on the printer.

**Note:**

Before introducing this feature to your network, consult your sales representative for more information. For details on the fax server, consult the service provider for Internet faxes.

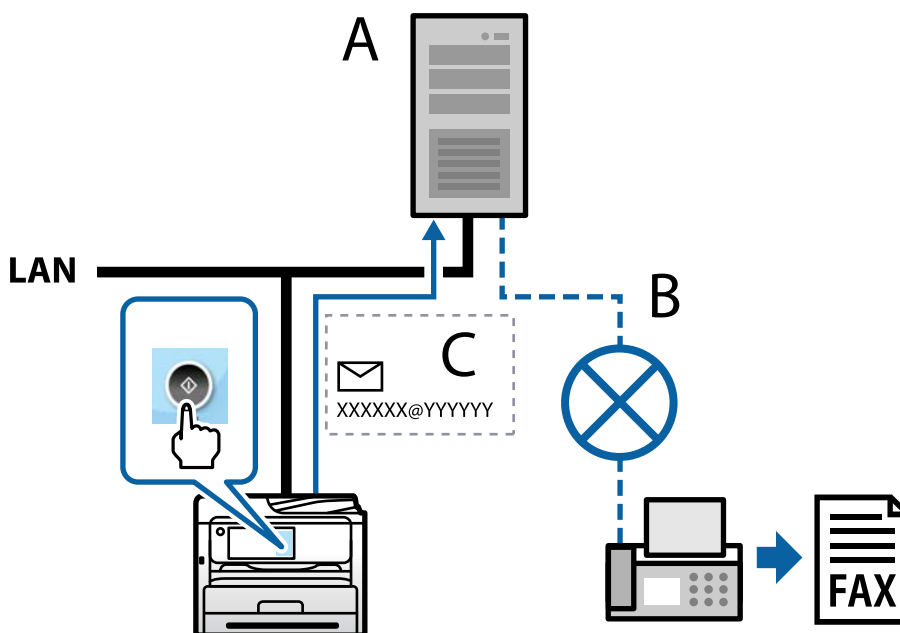

A: Fax server

B: Public Switched Telephone Network (PSTN)

C: E-mail with fax data attached

**You need a fax server with the following features.**

- The ability to receive fax data with e-mails in the "XXXXXX@YYYYYY" format, and send faxes to a fax number XXXXXX  
XXXXXX: Fax number  
YYYYYY: Fax server's domain name added by the printer
- The ability to handle multi-Tiff format fax data attached to an e-mail

---

## Settings for Printing, Scanning, Copying and Faxing

### Initial Settings for Printing

Set the print settings, such as paper size or printing error.

### Using the Print Functions

Enable to use the print function through the network.

To use the printer on the network, you need to set the port for network connection on the computer as well as the printer's network connection.

#### ***Printer Connection Types***

The following two methods are available for the printer's network connection.

- Peer to peer connection (direct printing)
- Server / client connection (printer sharing using the Windows server)

#### **Peer to Peer Connection Settings**

This is the connection to connect the printer on the network and the computer directly. Only a network-capable model can be connected.

#### **Connection method:**

Connect the printer to the network directly via hub or access point.

#### **Printer driver:**

Install the printer driver on each client computer.

When using EpsonNet SetupManager, you can provide the driver's package that includes the printer settings.

### Features:

- The print job starts immediately because the print job is sent to the printer directly.
- You can print as long as the printer runs.

### Server / Client Connection Settings

This is the connection that the server computer shares with the printer. To prohibit the connection without going through the server computer, you can enhance the security.

When using USB, the printer without the network function can be also shared.

### Connection method:

Connect the printer to the network via LAN switch or access point.

You can also connect the printer to the server directly by USB cable.

### Printer driver:

Install the printer driver on the Windows server depending on the OS of the client computers.

By accessing the Windows server and linking the printer, the printer driver is installed on the client computer and can be used.

### Features:

- Manage the printer and the printer driver in batch.
- Depending on the server spec, it may take time to start the print job because all print jobs go through the print server.
- You cannot print when the Windows server is turned off.

### *Print Settings for Peer to Peer Connection*

For peer to peer connection (direct printing), a printer and a client computer have a one-to-one relationship.

The printer driver must be installed on each client computer.

### *Print Settings for Server / Client Connection*

Enable to print from the printer that is connected as the server / client connection.

For the server / client connection, set up the print server first, and then share the printer on the network.

When using the USB cable to connect to the server, also set the print server first, and then share the printer on the network.

### Setting Up the Network Ports

Create the print queue for network printing on the print server by using standard TCP/IP, and then set the network port.

This example is when using Windows Server 2012 R2.

1. Open the devices and printers screen.

**Desktop > Settings > Control Panel > Hardware and Sound or Hardware > Devices and Printers.**

2. Add a printer.  
Click **Add printer**, and then select **The printer that I want isn't listed**.
3. Add a local printer.  
Select **Add a local printer or network printer with manual settings**, and then click **Next**.
4. Select **Create a new port**, select **Standard TCP/IP Port** as the Port Type, and then click **Next**.

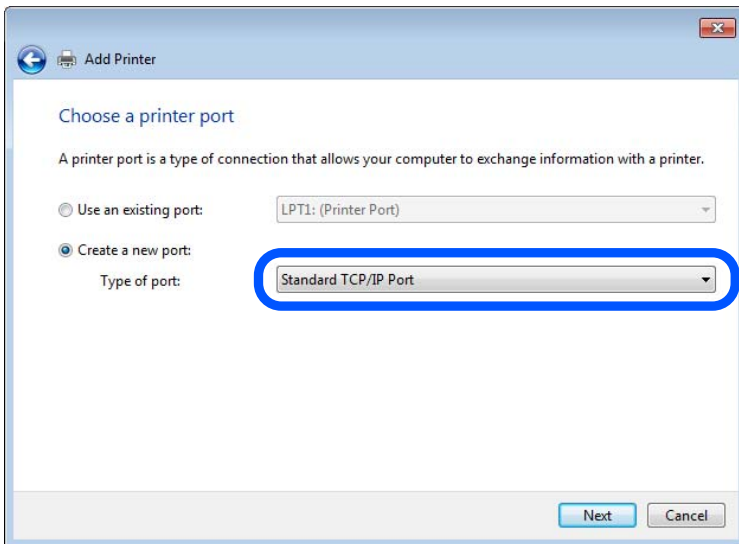

5. Enter the printer's IP address or printer name in **Host Name or IP Address** or **Printer Name or IP Address**, and then click **Next**.

Example:

- Printer name : EPSONA1A2B3C
- IP address : 192.0.2.111

Do not change **Port name**.

Click **Continue** when the **User Account Control** screen is displayed.

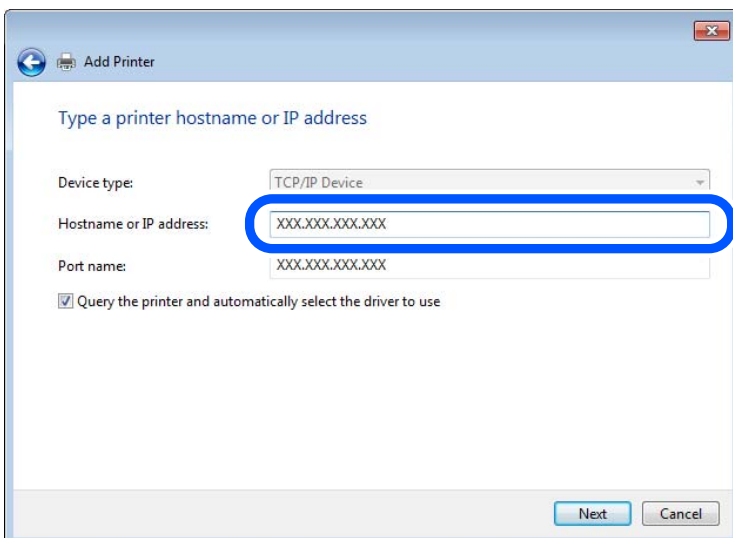

**Note:**

If you specify the printer name on the network where the name resolution is available, the IP address is tracked even if printer's IP address has been changed by DHCP. You can confirm the printer name from the network status screen on the printer's control panel or network status sheet.

6. Set the printer driver.
  - If the printer driver is already installed:  
Select **Manufacturer** and **Printers**. Click **Next**.
7. Follow the on-screen instructions.

When using the printer under the server / client connection (printer sharing using the Windows server), make the sharing settings hereafter.

### Checking the Port Configuration - Windows

Check if the correct port is set for the print queue.

1. Open the devices and printers screen.  
**Desktop > Settings > Control Panel > Hardware and Sound** or **Hardware > Devices and Printers**.
2. Open the printer properties screen.  
Right-click the printer icon, and then click **Printer properties**.
3. Click the **Ports** tab, select **Standard TCP/IP Port**, and then click **Configure Port**.
4. Check the port configuration.
  - For RAW  
Check that **Raw** is selected in **Protocol**, and then click **OK**.
  - For LPR  
Check that **LPR** is selected in **Protocol**. Enter "PASSTHRU" in **Queue name** from **LPR Settings**. Select **LPR Byte Counting Enabled**, and then click **OK**.

### Sharing the Printer (Windows only)

When using the printer under the server / client connection (printer sharing using the Windows server), set up the printer sharing from the print server.

1. Select **Control Panel > View devices and printers** on the print server.
2. Right-click the printer icon (print queue) that you want to share with, and then select **Printer Properties > Sharing** tab.
3. Select **Share this printer** and then enter to **Share name**.  
For Windows Server 2012, click **Change Sharing Options** and then configure the settings.

### Installing Additional Drivers (Windows only)

If the Windows versions for a server and clients are different, it is recommended to install additional drivers to the print server.

1. Select **Control Panel > View devices and printers** on the print server.
2. Right-click the printer icon that you want to share with the clients, and then click **Printer Properties > Sharing** tab.
3. Click **Additional Drivers**.  
For Windows Server 2012, click Change Sharing Options and then configure the settings.
4. Select versions of Windows for clients, and then click OK.
5. Select the information file for the printer driver (\*.inf) and then install the driver.

### Using the Shared Printer – Windows

The administrator needs to inform the clients of the computer name assigned to the print server and how to add it to their computers. If the additional driver(s) have not been configured yet, inform the clients how to use **Devices and Printers** to add the shared printer.

If additional driver(s) have already been configured on the print server, follow these steps:

1. Select the name assigned to the print server in **Windows Explorer**.
2. Double-click the printer that you want to use.

### Setting the Paper Source

Set the size and type of paper to be loaded in each paper source.

1. Enter the printer's IP address into a browser to access Web Config.  
Enter the printer's IP address from a computer that is connected to the same network as the printer.  
You can check the IP address of the printer from the following menu.  
**Settings > General Settings > Network Settings > Network Status > Wired LAN/Wi-Fi Status**
2. Enter the administrator password to log in as an administrator.
3. Select in the following order.  
**Print tab > Paper Source Settings**
4. Set each item.  
The displayed items may vary by the situation.
  - Paper source name**  
Display the target paper source name, such as **Paper Tray, Cassette 1**.
  - Paper Size**  
Select the paper size you want to set from the pull-down menu.
  - Unit**  
Select the unit of the user-defined size. You can select it when **User defined** is selected on **Paper Size**.

**Width**

Set the horizontal length of the user-defined size.

The range you can enter here depends on the paper source, which is indicated on the side of **Width**.

When you select **mm** in **Unit**, you can enter up to one decimal place.

When you select **inch** in **Unit**, you can enter up to two decimal places.

**Height**

Set the vertical length of the user-defined size.

The range you can enter here depends on the paper source, which is indicated on the side of **Height**.

When you select **mm** in **Unit**, you can enter up to one decimal place.

When you select **inch** in **Unit**, you can enter up to two decimal places.

**Paper Type**

Select the paper type you want to set from the pull-down menu.

5. Check the settings, and then click **OK**.

**Related Information**

➔ [“Default Value of the Administrator Password” on page 19](#)

## Setting the Interface

Set the timeout of the print jobs or printing language assigned to each interface.

This item is displayed on the PCL or PostScript compatible printer.

1. Enter the printer's IP address into a browser to access Web Config.

Enter the printer's IP address from a computer that is connected to the same network as the printer.

You can check the IP address of the printer from the following menu.

**Settings > General Settings > Network Settings > Network Status > Wired LAN/Wi-Fi Status**

2. Enter the administrator password to log in as an administrator.

3. Select in the following order.

**Print tab > Interface Settings**

4. Set each item.

**Timeout Settings**

Set the timeout of the print jobs sent directly via USB.

You can set between 5 and 300 seconds by the second.

When you do not want to timeout, enter 0.

**Printing Language**

Select the printing language for each USB interface and network interface.

When you select **Auto**, the printing language is automatically detected by the print jobs being sent.

5. Check the settings, and then click **OK**.



### Related Information

➔ [“Default Value of the Administrator Password” on page 19](#)

## Setting Errors

Set the displaying error for the device.

1. Enter the printer's IP address into a browser to access Web Config.  
Enter the printer's IP address from a computer that is connected to the same network as the printer.  
You can check the IP address of the printer from the following menu.  
**Settings > General Settings > Network Settings > Network Status > Wired LAN/Wi-Fi Status**
2. Enter the administrator password to log in as an administrator.
3. Select in the following order.  
**Print tab > Error Settings**
4. Set each item.
  - Paper Size Notice  
Set whether to display an error on the control panel when the paper size of the specified paper source is different from the paper size of the print data.
  - Paper Type Notice  
Set whether to display an error on the control panel when the paper type of the specified paper source is different from the paper type of the print data.
  - Auto Error Solver  
Set whether to automatically cancel the error if there is no operation on the control panel for 5 seconds after displaying the error.
5. Check the settings, and then click **OK**.

### Related Information

➔ [“Default Value of the Administrator Password” on page 19](#)

## Setting Universal Print

Set when you print from external devices without using the printer driver.

Some items are not displayed depending on the printing language of your printer.

1. Enter the printer's IP address into a browser to access Web Config.  
Enter the printer's IP address from a computer that is connected to the same network as the printer.  
You can check the IP address of the printer from the following menu.  
**Settings > General Settings > Network Settings > Network Status > Wired LAN/Wi-Fi Status**
2. Enter the administrator password to log in as an administrator.

3. Select in the following order.  
     **Print** tab > **Universal Print Settings**
4. Set each item.
5. Check the settings, and then click **OK**.

**Related Information**

➔ [“Default Value of the Administrator Password” on page 19](#)

**Basic**

Items	Explanation
Top Offset(-30.0-30.0mm)	Sets the vertical position of the paper on which printing starts.
Left Offset(-30.0-30.0mm)	Sets the horizontal position of the paper on which printing starts.
Top Offset in Back(-30.0-30.0mm)	Sets the vertical position of the paper on which the printing of the back side of the paper starts in duplex printing.
Left Offset in Back(-30.0-30.0mm)	Sets the horizontal position of the paper on which the printing of the back side of the paper starts in duplex printing.
Check Paper Width	Set whether to check paper width when printing.
Skip Blank Page	If there is a blank page in the print data, set not to print a blank page.

**PDL Print Configuration**

You can specify settings for PCL or PostScript printing.  
 This item is displayed on a PCL or PostScript compatible printer.

**Common Settings**

Items	Explanation
Paper Size	Select the paper size on which you want to print.
Paper Type	Select the type of paper on which you print.
Orientation	Select the orientation you want to use to print.
Quality	Select the print quality you want to use for printing.
Ink Save Mode	Set whether to print with reduced ink consumption.
Print Order	Select to print from the top or the last page.
Number of Copies(1-999)	Set the number of copies you want to print.
Binding Margin	Select the binding position.
Auto Paper Ejection	Select whether to eject paper automatically when timeout is occurred during receiving a print job.

Items	Explanation
2-Sided Printing	Set whether printing 2-sided.

### PCL Menu

Items	Explanation
Font Source	Select whether to use the font installed on the printer or download it.
Font Number	Specify the font number you want to use.
Pitch(0.44-99.99cpi)	If the font to use is scalable and fixed-pitch font, specify the font size in pitch.
Height(4.00-999.75pt)	If the font to use is scalable and proportional font, specify the font size in points.
Symbol Set	Select the symbol set of the font you want to use.
Form(5-128lines)	Specify the number of lines per page.
CR Function	Select the operation for the CR code (return).
LF Function	Select the operation for the LF code (new line), FF code (new page).
Paper Source Assign	Specify paper feeder assignment for PCL paper feed command.

### PS Menu

Items	Explanation
Error Sheet	Set whether to print an error sheet when PS3 printing error occurs.
Coloration	Set as color printing or monochrome printing. You can only select monochrome for this printer.
Binary	Set whether to accept the binary data or not.
PDF Page Size	Set the paper size for PDF printing.

## Setting Up Universal Print (Microsoft)

You can setup your printer to use Universal Print. To use this function, you need to be using Microsoft 365 and Azure Active Directory service.

1. Enter the printer's IP address into a browser to access Web Config.  
Enter the printer's IP address from a computer that is connected to the same network as the printer.  
You can check the IP address of the printer from the following menu.  
**Settings > General Settings > Network Settings > Network Status > Wired LAN/Wi-Fi Status**
2. Enter the administrator password to log in as an administrator.
3. Select in the following order.  
**Network tab > Universal Print**

4. Click **Register**.
5. Read the message displayed, and then click the link.
6. Follow the on-screen instructions to register the printer.

If the registration status displays **Registered** on the Web Config screen after registration, then setup is complete.

**Note:**

For details on operating the Azure Active Directory, such as how to use Universal Print, see the Microsoft web site.

**Related Information**

➔ [“Default Value of the Administrator Password” on page 19](#)

## Setting Up AirPrint

Set when using AirPrint printing and scanning.

Access Web Config and select the **Network** tab > **AirPrint Setup**.

Items	Explanation
Bonjour Service Name	Enter the Bonjour service name between 1 and 41 characters in ASCII (0x20-0x7E).
Bonjour Location	Enter location information such as the printer's placement within 127 bytes or less in Unicode (UTF-8).
Geolocation Latitude and Longitude (WGS84)	Enter the printer's location information. This entry is optional. Enter values by using WGS-84 datum, which separates latitude and longitude with a comma. You can enter -90 to +90 for the latitude value, and -180 to +180 for the longitude value. You can enter less than a decimal to the sixth place, and you can omit "+".
Top Priority Protocol	Select top priority protocol from IPP and Port9100.
Wide-Area Bonjour	Set whether or not to use Wide-Area Bonjour. If you use it, the printers must be registered on the DNS server to be able to search the printer over the segment.
iBeacon Transmission	Select whether to enable or disable the iBeacon transmission function. When enabled, you can search for the printer from iBeacon-enabled devices.
Require PIN Code when using IPP printing	Select whether or not to require a PIN code when using IPP printing. If you select <b>Yes</b> , IPP print jobs without PIN codes are not saved in the printer.
Enable AirPrint	IPP, Bonjour, AirPrint (Scan service) are enabled, and IPP is established only with secure communication.

## Preparing Scanning or Copying

### Preparing to Scan

#### *Scanning using the control panel*

Setup servers or folders before scanning.

#### Settings of Servers and Folders

Name	Settings	Location	Requirement
Scan to Network Folder (SMB)	Create and set up sharing of the save folder	A computer that has a save folder location	The administrative user account to the computer that creates save folders.
	Destination for Scan to Network Folder (SMB)	Contacts of the device	User name and password to log on to the computer that has the save folder, and the privilege to update the save folder.
Scan to Network Folder (FTP)	Setup for FTP server log on	Contacts of the device	Logon information for the FTP server and the privilege to update the save folder.
Scan to Email	Setup for email server	Device	Setup information for email server
Scan to Cloud	Printer registration to Epson Connect	Device	Internet connection environment
	Contact registration to Epson Connect	Epson Connect service	User and printer registration to Epson Connect service
Scan to Computer (when using Document Capture Pro Server)	Server mode setup for Document Capture Pro	Device	IP address, host name, or FQDN for the computer that Document Capture Pro Server is installed on

#### Related Information

- ➔ [“Setting a Shared Network Folder” on page 69](#)
- ➔ [“Configuring a Mail Server” on page 65](#)

#### **Using Document Capture Pro Server**

By using Document Capture Pro Server, you can manage the sorting method, saving format, and forwarding destination of a scanning result executed from the printer's control panel. You can call and execute a job previously registered on the server from the printer's control panel.

Install it on the server computer.

For more information on Document Capture Pro Server, contact your local Epson office.

### Setting Server Mode

To use Document Capture Pro Server, set up **Server Mode** from Web Config.

**Note:**

You can also set **Server Mode** from the control panel by accessing the following menu.

**Settings > General Settings > Scan Settings > Document Capture Pro > Operation Mode**

1. Enter the printer's IP address into a browser to access Web Config.  
Enter the printer's IP address from a computer that is connected to the same network as the printer.  
You can check the IP address of the printer from the following menu.  
**Settings > General Settings > Network Settings > Network Status > Wired LAN/Wi-Fi Status**
2. Enter the administrator password to log in as an administrator.
3. Select in the following order.  
**Scan/Copy tab > Document Capture Pro**
4. Select **Server Mode** for **Mode**.
5. Enter the address of the server with Document Capture Pro Server installed on it for **Server Address**.  
Enter between 2 and 255 characters in either IPv4, IPv6, host name or FQDN format. For FQDN format, you can use alphanumeric characters in ASCII (0x20-0x7E) and "-" except for at the beginning and end of the address.
6. Click **OK**.  
The network is re-connected, and then the settings are enabled.

### Related Information

➔ [“Default Value of the Administrator Password” on page 19](#)

### Scanning From a Computer

Install the software and check that the network scan service is enabled to scan via a network from the computer.

#### Software to be installed

Epson Scan 2

This is a scanner driver. If you use the device from a computer, install the driver on each client computer. If Document Capture Pro/Document Capture is installed, you can perform the operations assigned to the buttons of the device.

If EpsonNet SetupManager is used, the printer driver is also distributed as a package.

Document Capture Pro (Windows)/Document Capture (Mac OS)

It is installed on the client computer. The jobs registered on a network computer where Document Capture Pro/Document Capture is installed can be called and run from the device's control panel.

You can scan over the network from a computer. Epson Scan 2 is required to scan.

### Confirming that Network Scan is Enabled

You can set the network scan service when you scan from a client computer over the network. The default setting is enabled.

1. Enter the printer's IP address into a browser to access Web Config.  
Enter the printer's IP address from a computer that is connected to the same network as the printer.  
You can check the IP address of the printer from the following menu.  
**Settings > General Settings > Network Settings > Network Status > Wired LAN/Wi-Fi Status**
2. Enter the administrator password to log in as an administrator.
3. Select in the following order.  
**Scan/Copy tab > Network Scan**
4. Make sure that **Enable scanning of EPSON Scan** is selected.  
If it is selected, this task is completed. Close Web Config.  
If it is cleared, select it and go to next step.
5. Click **Next**.
6. Click **OK**.  
The network is re-connected, and then the settings are enabled.

### Related Information

➔ [“Default Value of the Administrator Password” on page 19](#)

## Making Fax Features Available

### Before Using Fax Features

Set up the following to use the fax features.

- Connect the printer correctly with the phone line, and (if it is being used) the phone machine  
[“Connecting the Printer to a Phone Line” on page 116](#)
- Complete the **Fax Setting Wizard**, which is required to make basic settings.  
[“Making the Printer Ready to Send and Receive Faxes” on page 119](#)

Set the following as necessary.

- Contacts** registration  
[“Contacts Registration” on page 87](#)

- Output destinations and related settings, such as network settings and mail server settings
  - [“Configuring a Mail Server” on page 65](#)
  - [“Setting a Shared Network Folder” on page 69](#)
  - [“Settings to use Your Cloud Service as Forwarding Fax Destinations” on page 97](#)
  - [“Making Settings for the Printer's Fax Features According to Use” on page 121](#)
  - [“Fax Settings” on page 369](#)
- User Settings** that define default values for **Fax** menu items
  - [“User Settings” on page 392](#)
- Report Settings** to print reports when faxes are sent, received, or forwarded
  - [“Report Settings” on page 383](#)
- Solving Problems when making fax settings
  - [“Troubleshooting Fax Problems” on page 133](#)

## Connecting the Printer to a Phone Line

### **Compatible Telephone Lines**

You can use the printer over standard analogue telephone lines (PSTN = Public Switched Telephone Network) and PBX (Private Branch Exchange) telephone systems.

You may not be able to use the printer with the following phone lines or systems.

- VoIP phone line such as DSL or fiber-optic digital service
- Digital phone line (ISDN)
- Some PBX telephone systems
- When adapters such as terminal adapters, VoIP adapters, splitters, or DSL router are connected between the telephone wall jack and the printer

### **Connecting the Printer to a Phone Line**

Connect the printer to a telephone wall jack using an RJ-11 (6P2C) phone cable. When connecting a telephone to the printer, use a second RJ-11 (6P2C) phone cable.

Depending on the area, a phone cable may be included with the printer. If it is included, use that cable.

You may need to connect the phone cable to an adapter provided for your country or region.

#### **Note:**

*Remove the cap from the EXT. port of the printer only when connecting your telephone to the printer. Do not remove the cap if you are not connecting your telephone.*

In areas where lightning strikes occur frequently, we recommend that you use a surge protector.



### Connecting to a Standard Phone Line (PSTN) or PBX

Connect a phone cable from the telephone wall jack or PBX port to the LINE port on the back of the printer.

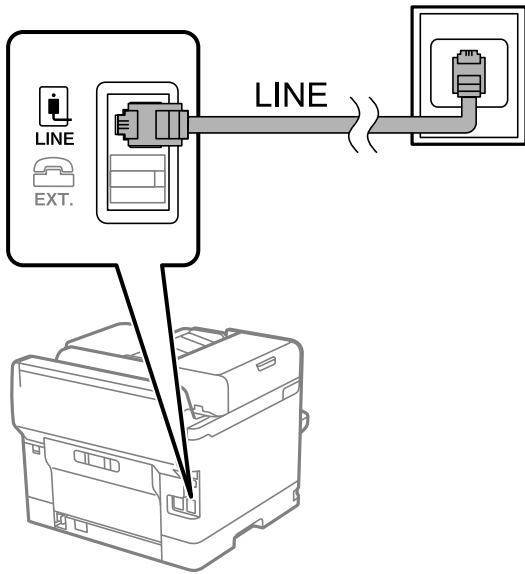

### Connecting to DSL or ISDN

Connect a phone cable from the DSL modem or the ISDN terminal adapter to the LINE port on the back of the printer. See the documentation provided with the modem or the adapter for more details.

**Note:**

*If your DSL modem is not equipped with a built-in DSL filter, connect a separate DSL filter.*

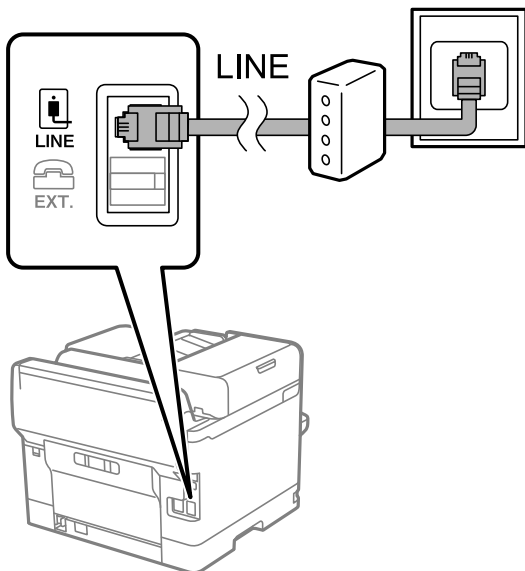

### Connecting Your Phone Device to the Printer

When using the printer and your telephone on a single phone line, connect the telephone to the printer.

**Note:**

- ❑ If your phone device has a fax function, disable the fax function before connecting. See the manuals that came with the phone device for details. Depending on the model of the phone device, the fax function cannot be completely disabled, so you may not be able to use it as an external phone.
- ❑ If you connect an answering machine, make sure the printer's **Rings to Answer** setting is set higher than the number of rings your answering machine is set to answer a call.

1. Remove the cap from the EXT. port on the back of the printer.

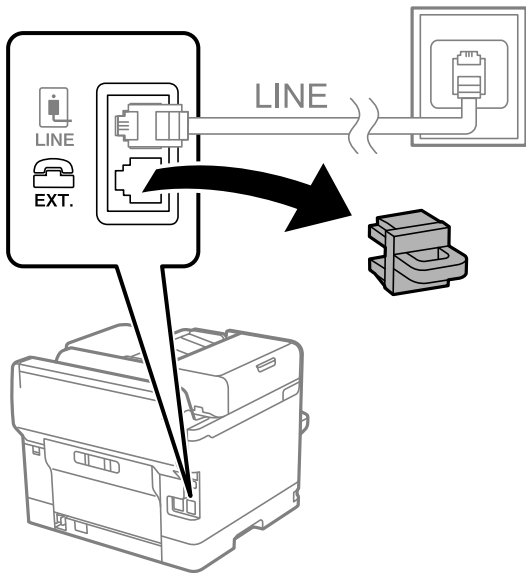

2. Connect the phone device and the EXT. port with a phone cable.

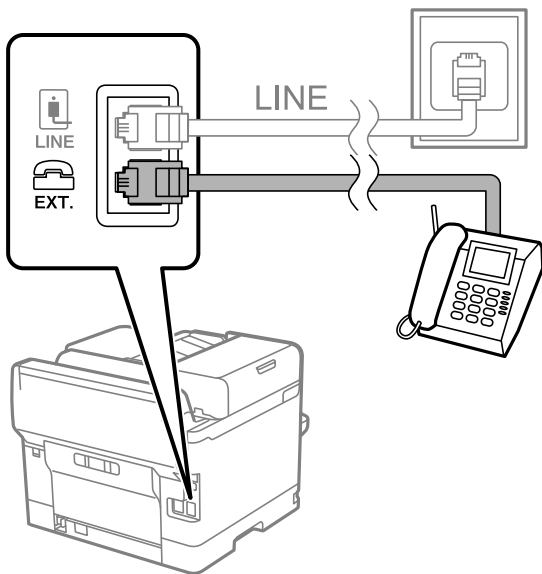

**Note:**

When sharing a single phone line, make sure you connect the phone device to the EXT. port of the printer. If you split the line to connect the phone device and the printer separately, the phone and the printer do not work correctly.

3. Select **Fax** on the printer's control panel.

4. Pick up the handset.

If a message to start sending or receiving faxes is displayed as shown on the following screen, the connection has been established.



### Related Information

- ➔ [“Making the Printer Ready to Send and Receive Faxes” on page 119](#)
- ➔ [“Making Settings to Use an Answering Machine” on page 122](#)
- ➔ [“Making Settings to Receive Faxes Operating Only a Connected Phone” on page 122](#)
- ➔ [“Receive Mode:” on page 371](#)

## Making the Printer Ready to Send and Receive Faxes

**Fax Setting Wizard** configures the basic fax features to make the printer ready to send and receive faxes.

The Wizard is displayed automatically when the printer is turned on for the first time. You can also display the wizard manually from the printer's control panel. You need to run the wizard again in case the wizard is skipped when the printer is first turned on or when the connection environment has changed.

- The items below are what you can set through the wizard.
  - Header (Your Phone Number and Fax Header)**
  - Receive Mode (Auto or Manual)**
  - Distinctive Ring Detection (DRD) Setting**
- The items below are set automatically according to the connection environment.
  - Dial Mode (such as Tone or Pulse)**  
**Fax Setting Wizard** may not configure **Dial Mode** automatically when **Line Type** is set to **PBX**. Configure **Dial Mode** manually.
- Other items in **Basic Settings** remain as they are.

### Related Information

- ➔ [“Basic Settings” on page 370](#)

### ***Making the Printer Ready to Send and Receive Faxes Using Fax Setting Wizard***

1. Select **Settings** on the home screen on the printer's control panel.

2. Select **General Settings** > **Fax Settings** > **Fax Setting Wizard**.

3. Following the on-screen instructions, enter the sender name such as your company name, your fax number.

**Note:**

*Your sender name and your fax number appear as the header for outgoing faxes.*

4. Make the distinctive ring detection (DRD) setting.

If you have subscribed to a distinctive ring service from your telephone company:

Go to the next screen and select the ring pattern to be used for incoming faxes.

When you select any item except **All**, **Receive Mode** is set to **Auto** and you continue to the next screen where you can check the settings you made.

If you have not subscribed to a distinctive ring service from your telephone company, or you do not need to set this option:

Skip this setting and go to the screen where you can check the settings you made.

**Note:**

*Distinctive ring services, offered by many telephone companies (the service name differs by company), allows you to have several phone numbers on one phone line. Each number is assigned a different ring pattern. You can use one number for voice calls and another for fax calls. Select the ring pattern assigned to fax calls in **DRD**.*

*Depending on the region, **On** and **Off** are displayed as the **DRD** options. Select **On** to use the distinctive ring feature.*

5. Make the Receive Mode setting.

If you do not need to connect a phone device to the printer:

Select **No**.

**Receive Mode** is set to **Auto**.

If you need to connect a phone device to the printer:

Select **Yes**, and then select whether or not to receive faxes automatically.

6. Check the settings you made on the screen displayed, and then proceed to the next screen.

To correct or change settings, select .

7. Check the fax connection by selecting **Start Checking**, and then select **Print** to print a report that shows the connection status.

**Note:**

*If there are any errors reported, follow the instructions on the report to solve them.*

*If the **Select Line Type** screen is displayed, select the line type.*

- *When you are connecting the printer to a PBX phone system or terminal adapter, select **PBX**.*

- *When you are connecting the printer to a standard phone line, select **PSTN**, and then select **Do Not Detect** on the **Confirmation** screen displayed. However, setting this to **Do Not Detect** may cause the printer to skip the first digit of a fax number when dialing and send the fax to the wrong number.*

**Related Information**

➔ [“Connecting the Printer to a Phone Line” on page 116](#)

➔ [“Making Settings to Use an Answering Machine” on page 122](#)

➔ [“Receive Mode:” on page 371](#)

➔ [“Making Settings to Receive Faxes Operating Only a Connected Phone” on page 122](#)

➔ [“Basic Settings” on page 370](#)

## Making Settings for the Printer's Fax Features According to Use

You can configure the printer's fax features individually using the printer's control panel according to use. The settings made using **Fax Setting Wizard** can also be changed. For more details, see the descriptions of the **Fax Settings** menu.

[“Fax Settings” on page 369](#)

**Note:**

- ❑ *Using Web Config, you can configure the printer's fax features.*
- ❑ *When you use Web Config to display the **Fax Settings** menu, there may be slight differences in the user interface and in location compared to the printer's control panel.*

### Related Information

- ➔ [“Settings for a PBX Phone System” on page 121](#)
- ➔ [“Receiving Incoming Faxes” on page 233](#)
- ➔ [“Making Settings When You Connect a Phone Device” on page 122](#)
- ➔ [“Settings to Save and Forward Received Faxes” on page 123](#)
- ➔ [“Settings to Save and Forward Received Faxes with Specific Conditions” on page 126](#)
- ➔ [“Making Settings for Blocking Junk Faxes” on page 131](#)
- ➔ [“Making Settings to Send and Receive Faxes on a Computer” on page 132](#)

### Settings for a PBX Phone System

#### Making Settings to Use the Access Code when Dialing an External Line

Make the following settings if you need to use numbers such as 0 or 9 as they are instead of as part of an external access code.

1. Select **Settings** on the printer's control panel.
2. Select **General Settings** > **Fax Settings** > **Basic Settings**.
3. Select **Line Type**, and then select **PBX**.
4. When sending a fax to an outside fax number using the actual external access code, select the **Access Code** box, and then select **Do Not Use**.
5. Select **OK** to apply the settings.

#### Making Settings to Send Faxes Using External Access Code (#)

You can send faxes to an outside fax number using # (hash) instead of the actual external access code such as 0 or 9.

1. Select **Settings** on the printer's control panel.
2. Select **General Settings** > **Fax Settings** > **Basic Settings**.
3. Select **Line Type**, and then select **PBX**.

4. Select the **Access Code** box, and then select **Use**.
5. Tap the **Access Code** input box, enter the external access code used for your phone system, and then tap **OK**.
6. Select **OK** to apply the settings.

The #, entered instead of the actual access code, is replaced with the stored access code, such as 0 or 9, when dialing. Using # helps avoid connection problems when connecting to an outside line.

**Note:**

*When **Access Code** is set to **Use**, you cannot send faxes to recipients in **Contacts** for which an external access code such as 0 or 9 is set.*

*If you have registered recipients in **Contacts** using an external access code such as 0 or 9, set the **Access Code** to **Do Not Use**. Otherwise, you must change the code to # in **Contacts**.*

### **Making Settings When You Connect a Phone Device**

#### **Making Settings to Use an Answering Machine**

You need settings to use an answering machine.

1. Select **Settings** on the printer's control panel.
2. Select **General Settings > Fax Settings > Basic Settings**.
3. Set **Receive Mode** to **Auto**.
4. Set the **Rings to Answer** setting of the printer to a higher number than the number of rings for the answering machine.

If **Rings to Answer** is set lower than the number of rings for the answering machine, the answering machine cannot receive voice calls to record voice messages. See the manuals that came with the answering machine for its settings.

The printer's **Rings to Answer** setting may not be displayed, depending on the region.

#### **Related Information**

➔ [“Basic Settings” on page 370](#)

#### **Making Settings to Receive Faxes Operating Only a Connected Phone**

You can start receiving incoming faxes by only picking up the handset and operating the phone, without operating the printer at all.

The **Remote Receive** feature is available for telephones that support tone dialing.

1. Select **Settings** on the printer's control panel.
2. Select **General Settings > Fax Settings > Basic Settings > Remote Receive**.
3. Tap **Remote Receive** to set this to **On**.
4. Select **Start Code**, enter a two digit code (you can enter 0 to 9, \*, and #), and then tap **OK**.

5. Select **OK** to apply the settings.

### Related Information

- ➔ [“Basic Settings” on page 370](#)

### Settings to Save and Forward Received Faxes

The printer is set to print received faxes by default. Besides printing, you can set the printer to save and/or forward received faxes without conditions.

#### Note:

- As well as using the printer's control panel, you can also make settings using Web Config.*
- You can also save and/or forward received faxes with conditions.*

[“Settings to Save and Forward Received Faxes with Specific Conditions” on page 126](#)

### Related Information

- ➔ [“Making Saving Settings to Receive Faxes” on page 123](#)
- ➔ [“Forwarding Settings to Receive Faxes” on page 125](#)

### Making Saving Settings to Receive Faxes

You can make saving settings to receive faxes to the inbox and an external memory device regardless of the sender or time. Saving a fax to the inbox allows you to confirm the contents of the received fax by viewing the fax on the printer's LCD screen before the printer prints the fax.

To make settings to save received faxes to a computer using the PC-FAX feature, see [“Feature: PC-FAX Send/Receive \(Windows/Mac OS\)” on page 221](#).

#### Note:

- As well as using the printer's control panel, you can use Web Config to make saving settings to receive faxes. Select the **Fax** tab > **Save/Forward Settings** > **Unconditional Save/Forward**, and then make the saving destination settings in **Fax Output**.*
- You can also print and/or forward the received faxes at the same time. Make the settings on the **Fax Output** screen mentioned above.*

1. Select **Settings** on the printer's control panel, and then select **General Settings** > **Fax Settings**.
2. Select **Receive Settings** > **Save/Forward Settings** > **Unconditional Save/Forward**.

When a message is displayed, check the content, and then tap **OK**.

3. Make settings for the saving destinations, the inbox and/or an external memory device.



- To save received faxes to the Inbox:
  - 1 Select **Save to Inbox** to set this to **On**.
  - 2 If a message is displayed, check the content, and then select **OK**.
- To save received faxes to an external memory device:
  - 1 Insert a memory device into the printer's external interface USB port.
  - 2 Select **Save to Memory Device**.
  - 3 Select **Yes**. To print the documents automatically while saving them in the memory device, select **Yes and Print** instead.
  - 4 Check the message that is displayed, and then tap **Create**.  
A folder for saving received documents is created in the memory device.
  - 5 Check the message, tap **Close** or wait until the message is cleared, and then tap **Close**.
  - 6 When the next message is displayed, check it, and then tap **OK**.



**Important:**

Received documents are saved in the printer's memory temporarily before the documents are saved in the memory device connected to the printer. Because a memory full error disables sending and receiving faxes, keep the memory device connected to the printer.

**Note:**

You can set the printer to send emails to people you want to notify about the results of saving faxes, when saving is complete. As necessary, select **Email Notifications**, set the processes, and then set the destination to which you want to send notifications.

4. Select **Close** to complete the **Unconditional Save/Forward** Settings.

This completes making unconditional saving settings to receive faxes. You can set **Common Settings** as necessary. For details, see the explanation for **Common Settings** in the **Save/Forward Settings** menu.

**Note:**

If you want to save received faxes with conditions, see the related information link below.

**Related Information**

- ➔ [“Save/Forward Settings” on page 374](#)
- ➔ [“Viewing Received Faxes on the Printer's LCD Screen” on page 238](#)



### Forwarding Settings to Receive Faxes

You can make forwarding settings to up to five destinations, email addresses, shared folders, your cloud accounts and/or another fax machine regardless of the sender or time.

**Note:**

- ❑ *If you want to make settings to forward received faxes, first add the forwarding destinations to the contacts list or the cloud destination list. See the table below for which list to register.*

Destination Type	Contacts	Cloud Destination List
email address	✓	–
shared folder	✓	–
cloud account	–	✓
another fax machine	✓	–

- ❑ *Make the following settings according to the forwarding destination type.*
  - “Contacts Registration” on page 87*
  - “Configuring a Mail Server” on page 65*
  - “Setting a Shared Network Folder” on page 69*
  - “Settings to use Your Cloud Service as Forwarding Fax Destinations” on page 97*

### Making Forwarding Settings to Receive Faxes

**Note:**

- ❑ *As well as using the printer's control panel, you can use Web Config to make forwarding settings to receive faxes. Select the **Fax** tab > **Save/Forward Settings** > **Unconditional Save/Forward**, and then make the forwarding destination settings in **Fax Output**.*

- ❑ *You can also print and/or save received faxes at the same time. Make the settings on the **Fax Output** screen mentioned above.*

1. Select **Settings** on the printer's control panel, then select **General Settings** > **Fax Settings**.
2. Select **Receive Settings** > **Save/Forward Settings** > **Unconditional Save/Forward**.  
When a message is displayed, check the content, and then tap **OK**.
3. Make settings for up to five forwarding destinations.



- 1 Select **Forward**.

- ② Select **Yes**. To print the documents automatically while forwarding them, select **Yes and Print** instead.
- ③ Select **Destination > Add Entry**, and then select forwarding destinations from the contacts list or the cloud destination list. You can specify up to five forwarding destinations.

To switch the lists, tap  and select  (Cloud Destination List), or tap  and select  (Contacts).

- ④ Tap **Close** to finish selecting forwarding destinations, and then tap **Close**.
- ⑤ In **Options When Forwarding Failed**, select whether to print received documents or save them in the printer's Inbox when forwarding fails.
- ⑥ Tap **OK**.

 **Important:**

*When the Inbox is full, receiving faxes is disabled. You should delete the documents from the inbox once they have been checked. The number of documents that have failed to be forwarded is displayed on the  on the home screen, in addition to other unprocessed jobs.*

**Note:**

*You can set the printer to send emails to people you want to notify about the results of forwarding faxes when the forwarding process is complete. As necessary, select **Email Notifications**, set the processes, and then select the destination to which you want to send notifications from the contacts list.*

- 4. Select **Close** to complete the **Unconditional Save/Forward Settings**.

**Note:**

- This completes making unconditional forwarding settings to receive faxes. You can set **Common Settings** as necessary. For details, see the explanation for **Common Settings** in the **Save/Forward Settings** menu.
- If you have selected a shared folder on a network, an email address, or a cloud account as the forwarding destination, we recommend that you test if you can send an image to the destination.  
 Select **Scan > Email**, **Scan > Network Folder/FTP** from the printer's control panel, select the destination, and then start scanning.  
 If you have selected a cloud account, you can perform a test by forwarding an image that has been saved image in a fax box to the destination. Select **Fax Box** from the printer's control panel. Select  (Preview menu) > **Forward(Cloud)** for a fax box in which any scanned image has been saved, select the destination, and then start forwarding.

**Related Information**

➔ [“Save/Forward Settings” on page 374](#)

**Settings to Save and Forward Received Faxes with Specific Conditions**

You can save and/or forward received faxes under set conditions.

**Note:**

- The printer is set to print received faxes by default.
- You can also receive and save faxes without any conditions.  
[“Settings to Save and Forward Received Faxes” on page 123](#)

**Related Information**

- ➔ [“Making Saving Settings to Receive Faxes with Specific Conditions” on page 127](#)
- ➔ [“Forwarding Settings to Receive Faxes with Specific Conditions” on page 129](#)

### **Making Saving Settings to Receive Faxes with Specific Conditions**

You can make settings to save received faxes to the inbox and an external memory device from a specified sender or at a specified time. You can save received faxes to the inbox or an external memory device.

When multiple conditions (**Conditional Save/Forward**) are set, they are referenced in the order of the items, and the **Conditional Save/Forward** that matches first is executed.

Saving a fax in a confidential box or the inbox allows you to confirm the contents of the received fax by viewing the fax on the printer's LCD screen before the printer prints the fax.

Before you use the feature to save received faxes at a specified time, make sure the printer's **Date/Time** and **Time Difference** settings are correct. Access the menu from **Settings > General Settings > Basic Settings > Date/Time Settings**.

**Note:**

- As well as using the printer's control panel, you can use Web Config to make saving settings to receive faxes. Select the **Fax** tab > **Save/Forward Settings > Conditional Save/Forward**, select the number of the confidential box, and then select **Edit** and make the saving destination settings.
- You can also print and/or forward received faxes at the same time. Make the settings on the **Edit** screen mentioned above.

1. Select **Settings** on the printer's control panel, and then select **General Settings > Fax Settings**.
2. Select **Receive Settings > Save/Forward Settings > Conditional Save/Forward**, and then tap an unregistered box under **Conditional Save/Forward**.

**Note:**

If you want to change the settings for a registered box, tap  and change the settings.

3. Select the **Name** box and enter the name you want to register.
4. Select the **Condition(s)** box to make a condition setting.
  - Sender Fax ID match:** If the incoming fax number matches the conditions you selected in this item, the printer saves and forwards the received faxes.  
Select the **Sender Fax ID match** condition and enter the fax number (max. 20 digits) by selecting the **ID** box.
  - Subaddress(SUB) perfect match:** If the subaddress (SUB) is a perfect match, the printer saves and forwards the received faxes.  
Enable the Subaddress(SUB) perfect match setting and enter the password by selecting the **Subaddress(SUB)** box.
  - Password(SID) perfect match:** If the password (SID) is perfectly matched, the printer saves and forwards the received faxes.  
Enable the Password(SID) perfect match setting and input the password by selecting the **Password(SID)** box.
  - Receiving Time:** The printer saves and forwards received faxes during the specified time period.  
Enable the **Receiving Time** setting and then set the time in **Start Time** and **End Time**.

5. Select **Save/Forward Destination** and then make settings for the target destination, box, and/or an external memory device.

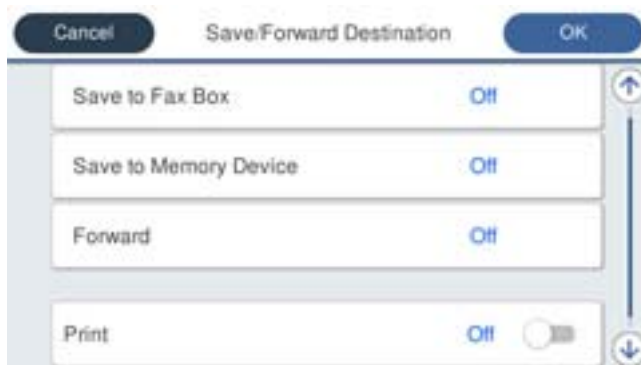

- To save the received faxes to the Inbox or a confidential box:
  - 1 Select **Save to Fax Box**.
  - 2 Tap **Save to Fax Box** to set this to **On**.
  - 3 Select the box in which to save the document.
- To save received faxes to an external memory device:
  - 1 Insert a memory device into the printer's external interface USB port.
  - 2 Select **Save to Memory Device**.
  - 3 Tap **Save to Memory Device** to set this to **On**.
  - 4 Check the message that is displayed, and then tap **Create**.

A folder for saving received documents is created in the memory device.



**Important:**

Received documents are saved in the printer's memory temporarily before the documents are saved in the memory device connected to the printer. Because a memory full error disables sending and receiving faxes, keep the memory device connected to the printer.

**Note:**

To print received faxes at the same time, tap **Print** to set this to **On**.

6. Select **OK** to complete the **Save/Forward Destination** Settings.

**Note:**

You can set the printer to send emails to people you want to notify about the results of saving faxes, when saving is complete. As necessary, select **Email Notifications**, set the processes, and then select the destination to which you want to send notifications from the contacts list.

7. Select **OK** until you return to the **Save/Forward Settings** screen to complete **Conditional Save/Forward**.
8. Select the registered box for which you made a condition setting, and then select **Enable**.

This completes making conditional saving settings to receive faxes. You can set **Common Settings** as necessary. For details, see the explanation for **Common Settings** in the **Save/Forward Settings** menu.

**Related Information**

➔ [“Save/Forward Settings” on page 374](#)

➔ [“Viewing Received Faxes on the Printer's LCD Screen” on page 238](#)

### Forwarding Settings to Receive Faxes with Specific Conditions

You can make forwarding settings to receive faxes from a specified sender or at a specified time.

When multiple conditions (**Conditional Save/Forward**) are set, they are referenced in the order of the items, and the **Conditional Save/Forward** that matches first is executed.

You can make forwarding settings to a destination, an email address, a shared folder, your cloud account or another fax machine from a specified sender or at a specified time.

**Note:**

If you want to make settings to forward received faxes, first add the forwarding destinations to the contacts list or the cloud destination list. See the table below for which list to register.

Destination Type	Contacts	Cloud Destination List
email address	✓	–
shared folder	✓	–
cloud account	–	✓
another fax machine	✓	–

Make the following settings according to the forwarding destination type.

[“Contacts Registration” on page 87](#)

[“Configuring a Mail Server” on page 65](#)

[“Setting a Shared Network Folder” on page 69](#)

[“Settings to use Your Cloud Service as Forwarding Fax Destinations” on page 97](#)

Before you use the feature to forward received faxes at a specified time, make sure the printer's **Date/Time** and **Time Difference** settings are correct. Access the menu from **Settings > General Settings > Basic Settings > Date/Time Settings**.

### Making Forwarding Settings to Receive Faxes with Specified Conditions

**Note:**

As well as using the printer's control panel, you can use Web Config to make forwarding settings to receive faxes. Select the **Fax** tab > **Save/Forward Settings > Conditional Save/Forward**, select the number of the confidential box, and then select **Edit** and make the forwarding destination settings.

You can also print and/or save received faxes at the same time. Make the settings on the **Edit** screen mentioned above.

1. Select **Settings** on the printer's control panel, and then select **General Settings > Fax Settings**.
2. Select **Receive Settings > Save/Forward Settings > Conditional Save/Forward**, and then tap an unregistered box under **Conditional Save/Forward**.

**Note:**

If you want to change the settings for a registered box, tap  and change the settings.

3. Select the **Name** box and enter the name you want to register.

4. Select the **Condition(s)** box to make a condition setting.

- Sender Fax ID match:** If the incoming fax number matches the conditions you selected in this item, the printer saves and forwards the received faxes.

Select the **Sender Fax ID match** condition and enter the fax number (max. 20 digits) by selecting the **ID** box.

- Subaddress(SUB) perfect match:** If the subaddress (SUB) is a perfect match, the printer saves and forwards the received faxes.

Enable the Subaddress(SUB) perfect match setting and enter the password by selecting the **Subaddress(SUB)** box.

- Password(SID) perfect match:** If the password (SID) is perfectly matched, the printer saves and forwards the received faxes.

Enable the Password(SID) perfect match setting and input the password by selecting the **Password(SID)** box.

- Receiving Time:** The printer saves and forwards received faxes during the specified time period.

Enable the **Receiving Time** setting and then set the time in **Start Time** and **End Time**.

5. Select **Save/Forward Destination**, and then make settings for a forwarding destination.

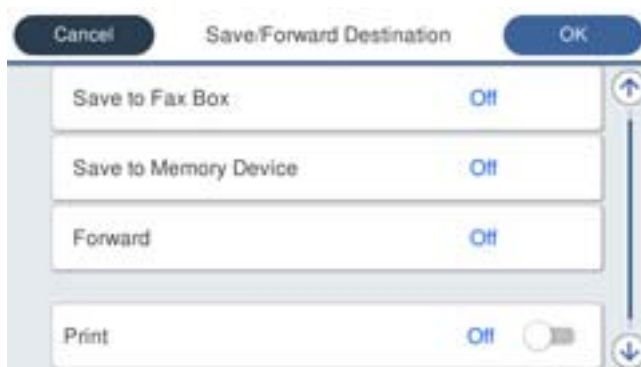

① Select **Forward**.

② Tap **Forward** to set this to **On**.

③ Select **Destination** > **Add Entry**, and then select a forwarding destination from the contacts list or the cloud destination list. You can specify a forwarding destination.

To switch the lists, tap  and select  (Cloud Destination List), or tap  and select  (Contacts).

④ When you have finished selecting forwarding destinations, tap **Close**.

⑤ Check that the forwarding destination you selected is correct, and then select **Close**.

⑥ In **Options When Forwarding Failed**, select whether to print received documents or save them in the printer's Inbox when forwarding fails.

⑦ Tap **OK**.

**! Important:**

*When the Inbox or a confidential box is full, receiving faxes is disabled. You should delete the documents from the inbox once they have been checked. The number of documents that have failed to be forwarded is displayed on the  on the home screen, in addition to other unprocessed jobs.*

**Note:**

To print received faxes at the same time, tap **Print** to set this to **On**.

6. Select **OK** to complete the **Save/Forward Destination** Settings.

**Note:**

You can set the printer to send emails to people you want to notify about the results of forwarding faxes when the forwarding process is complete. As necessary, select **Email Notifications**, set the processes, and then select the destination to which you want to send notifications from the contacts list.

7. Select **OK** until you return to the **Save/Forward Settings** screen to complete **Conditional Save/Forward**.
8. Select the registered box for which you made a condition setting, and then select **Enable**.

**Note:**

- This completes making conditional forwarding settings to receive faxes. You can set **Common Settings** as necessary. For details, see the explanation for **Common Settings** in the **Save/Forward Settings** menu.
- If you have selected a shared folder on a network, an email address, or a cloud account as the forwarding destination, we recommend that you test if you can send an image to the destination.  
Select **Scan > Email**, **Scan > Network Folder/FTP** from the printer's control panel, select the destination, and then start scanning.  
If you have selected a cloud account, you can perform a test by forwarding an image that has been saved in a fax box to the destination. Select **Fax Box** from the printer's control panel. Select  (Preview menu) > **Forward(Cloud)** for a fax box in which any scanned image has been saved, select the destination, and then start forwarding.

### Related Information

- ➔ [“Save/Forward Settings” on page 374](#)

### Making Settings for Blocking Junk Faxes

You can block junk faxes.

1. Select **Settings** on the printer's control panel.
2. Select **General Settings > Fax Settings > Basic Settings > Rejection Fax**.
3. Set the condition to block junk faxes.  
Select **Rejection Fax**, and then enable the following options.
  - Rejection Number List: Rejects faxes that are in the Rejection Number List.
  - Fax Header Blank: Rejects faxes that have blank header information.
  - Unregistered Contacts: Rejects faxes that have not been added to the contact list.
4. Tap  to return to the **Rejection Fax** screen.
5. If you are using the **Rejection Number List**, select **Edit Blocked Number list**, and then edit the list.

### Behavior for Rejecting Faxes

The printer behaves as follows.

- Ring tone rings

- Communication error is sent to the sender
- The action is recorded in Job History  
You can access the job history from the following:

**Job/Status > Job > Log**

- The action is recorded in Fax Log  
You can print the Fax Log from the following:

**Fax >  (More > Fax Report > Fax Log**

### ***Making Settings to Send and Receive Faxes on a Computer***

To send and receive faxes on a client computer, FAX Utility must be installed on the computer connected by network or USB cable.

### **Enabling Sending Faxes from a Computer**

Set up the following using Web Config.

1. Enter the printer's IP address into a browser to access Web Config.  
Enter the printer's IP address from a computer that is connected to the same network as the printer.  
You can check the IP address of the printer from the following menu.  
**Settings > General Settings > Network Settings > Network Status > Wired LAN/Wi-Fi Status**
2. Enter the administrator password to log in as an administrator.
3. Select in the following order.  
**Fax** tab, and then click **Send Settings**
4. Select **Use** for the **PC to FAX Function**.  
The default setting value of the **PC to FAX Function** is **Use**. To disable sending faxes from any computer, select **Do Not Use**.
5. Click **OK**.

### **Related Information**

➔ [“Default Value of the Administrator Password” on page 19](#)

### **Making Save to Computer Setting to Receive Faxes**

You can receive faxes on a computer by using the FAX Utility. Install FAX Utility on the client computer and make the setting. For details, see Basic Operations in the FAX Utility help (displayed on the main window).

The setting item below on the printer's control panel is set to **Yes**, and the faxes received can be saved on the computer.

**Settings > General Settings > Fax Settings > Receive Settings > Save/Forward Settings > Unconditional Save/Forward > Save to Computer**



### Making Save to Computer Setting to Also Print on the Printer to Receive Faxes

You can make the setting to print received faxes on the printer as well as save them on a computer.

1. Select **Settings** on the printer's control panel.
2. Select **General Settings > Fax Settings > Receive Settings**.
3. Select **Save/Forward Settings > Unconditional Save/Forward > Save to Computer > Yes and Print**.

### Making Save to Computer Setting not to Receive Faxes

To set the printer not to save received faxes on the computer, change the settings on the printer.

**Note:**

*You can also change the settings using the FAX Utility. However, if there are any faxes that have been unsaved to the computer, the feature does not work.*

1. Select **Settings** on the printer's control panel.
2. Select **General Settings > Fax Settings > Receive Settings**.
3. Select **Save/Forward Settings > Unconditional Save/Forward > Save to Computer > No**.

## Troubleshooting Fax Problems

### Cannot Send or Receive Faxes

The following causes can be considered.

#### ■ There are some problems in telephone wall jack.

##### Solutions

Check that the telephone wall jack works by connecting a phone to it and testing it. If you cannot make or receive calls, contact your telecommunication company.

#### ■ There are some problems in connecting to the telephone line.

##### Solutions

Select **Settings > General Settings > Fax Settings > Check Fax Connection** on the control panel to run the automatic fax connection check. Try the solutions printed on the report.

#### ■ Communication error occurs.

##### Solutions

Select **Slow(9,600bps)** in **Settings > General Settings > Fax Settings > Basic Settings > Fax Speed** on the control panel.

■ **Connected to a DSL phone line without DSL filter.**

**Solutions**

To connect to a DSL phone line, you need to use a DSL modem equipped with a built-in DSL filter, or install a separate DSL filter to the line. Contact your DSL provider.

[“Connecting to DSL or ISDN” on page 117](#)

■ **There are some problems in the DSL filter when you connect to a DSL phone line.**

**Solutions**

If you can not send or receive fax, connect the printer directly to a telephone wall jack to see if the printer can send a fax. If it works, the problem may be caused by the DSL filter. Contact your DSL provider.

## Cannot Send Faxes

The following causes can be considered.

■ **The connection line is set to PSTN in a facility where a private branch exchange (PBX) is being used.**

**Solutions**

Select **PBX** in **Settings > General Settings > Fax Settings > Basic Settings > Line Type** on the control panel.

■ **Your caller ID is blocked.**

**Solutions**

Contact your telecommunication company to unblock your caller ID. Some phones or fax machines automatically reject anonymous calls.

■ **The header information for outgoing faxes is not registered.**

**Solutions**

Select **Settings > General Settings > Fax Settings > Basic Settings > Header** and set up the header information. Some fax machines automatically reject incoming faxes that do not include header information.

## Cannot Receive Faxes

The following causes can be considered.

We also recommend checking the printer status in **Job/Status**, such as whether or not the printer is currently receiving the fax.

■ **The Receive Mode is set to Manual while an external phone device is connected to the printer.**

**Solutions**

If an external phone device is connected to the printer and is sharing a phone line with the printer, select **Settings > General Settings > Fax Settings > Basic Settings**, and then set **Receive Mode** to **Auto**.

■ **The subaddress and password are wrong.**

**Solutions**

When receiving faxes using the subaddress feature, check that the subaddress and password are correct.

Check with the sender that the subaddress and password match.

To change the subaddress or the password, select the menus on the control panel as described below, select the confidential box corresponding to the settings, and then set the correct **Condition(s)**.

**Settings > General Settings > Fax Settings > Receive Settings > Save/Forward Settings > Conditional Save/Forward**

■ **The sender's fax number has been registered to the Rejection Number List.**

**Solutions**

Make sure that the sender's number can be deleted from the **Rejection Number List** before deleting it. Delete it from **Settings > General Settings > Fax Settings > Basic Settings > Rejection Fax > Edit Blocked Number list**. Or disable the **Rejection Number List** in **Settings > General Settings > Fax Settings > Basic Settings > Rejection Fax > Rejection Fax**. Faxes sent from numbers that have been registered to this list are blocked when this setting is enabled.

■ **The sender's fax number has not been registered in the contacts list.**

**Solutions**

Register the sender's fax number to contact list. Or disable **Unregistered Contacts** in **Settings > General Settings > Fax Settings > Basic Settings > Rejection Fax > Rejection Fax**. Faxes sent from numbers that have not been registered to this list are blocked when this setting is enabled.

■ **The sender has sent the fax without header information.**

**Solutions**

Ask the sender if header information is setup on their fax machine. Or, disable **Fax Header Blank** in **Settings > General Settings > Fax Settings > Basic Settings > Rejection Fax > Rejection Fax**. Faxes that do not include header information are blocked when this setting is enabled.

■ **Subscribing to a call forwarding service.**

**Solutions**

If you have subscribed to a call forwarding service, the printer may not be able to receive faxes. Contact the service provider.

## **Cannot Send Faxes at a Specified Time**

■ **The printer's date and time is wrong.**

**Solutions**

Select **Settings > General Settings > Basic Settings > Date/Time Settings**, and then set the correct date and time.

## Cannot Save Received Faxes to a Memory Device

- **Saving received faxes to external memory is disabled.**

### Solutions

Select **Settings > General Settings > Fax Settings > Receive Settings**, and then enable **Save to Memory Device** in each menu.

## Received Faxes Are Not Printed

- **Printing received faxes is disabled under the current settings.**

### Solutions

Make settings to print received faxes in **Settings > General Settings > Fax Settings > Receive Settings > Save/Forward Settings** in each menu.

## The Quality of the Sent or Received Fax is Poor

- **ECM setting is disabled.**

### Solutions

Select **Settings > General Settings > Fax Settings > Basic Settings** and enable the **ECM** setting on the control panel. This may clear errors that occur due to connection problems. Note that the speed of sending and receiving faxes may be slower than when **ECM** is disabled.

## Cannot Make Calls on the Connected Telephone

- **The phone cable is not connected correctly.**

### Solutions

Connect the telephone to the **EXT.** port on the printer, and pick up the receiver. If you cannot hear a dial tone through the receiver, connect the phone cable correctly.

## Answering Machine Cannot Answer Voice Calls

- **The printer's Rings to Answer setting is set to less than the number of rings for your answering machine.**

### Solutions

Select **Settings > General Settings > Fax Settings > Basic Settings > Rings to Answer**, and then set a number higher than the number of rings for your answering machine.

## A Lot of Junk Faxes Have Been Received

- **The printer's feature to block junk faxes has not been set up.**

### Solutions

Make **Rejection Fax** settings in **Settings > General Settings > Fax Settings > Basic Settings**.

[“Making Settings for Blocking Junk Faxes” on page 131](#)

---

## Problems when Making Settings

### Hints to Solving Problems

Checking the error message

When trouble has occurred, first check whether there are any messages on the printer's control panel or driver screen. If you have the notification email set when the events occur, you can promptly learn the status.

Network connection report

Diagnose the network and the printer status, and then print the result.

You can find the diagnosed error from the printer side.

Checking the communication status

Check the communication status of server computer or client computer by using the command such as ping and ipconfig.

Connection test

For checking the connection between the printer to the mail server, perform the connection test from the printer. Also, check the connection from the client computer to the server to check the communication status.

Initializing the settings

If the settings and communication status show no problem, the problems may be solved by disabling or initializing the network settings of the printer, and then setting up again.

### Cannot Access Web Config

#### ■ The IP address is not assigned to the printer.

##### Solutions

A valid IP address may not be assigned to the printer. Configure the IP address using the printer's control panel. You can confirm the current setting information with a network status sheet or from the printer's control panel.

#### ■ The TLS version is not supported

##### Solutions

You need to communicate using TLS version 1.2 or later.

Version 1.0 or 1.1 of TLS is initially disabled.

If you want to communicate with TLS Version 1.0 or 1.1, first access Web Config from a device that can communicate with TLS Version 1.2 or later, and then enable TLS Version 1.0 or 1.1.

➔ [“Configuring Basic SSL/TLS Settings” on page 452](#)

## Web browser does not support the Encryption Strength for SSL/TLS.

### Solutions

SSL/TLS has the Encryption Strength. You can open Web Config by using a web browser that supports bulk encryptions as indicated below. Check you are using the a supported browser.

- 80bit: AES256/AES128/3DES
- 112bit: AES256/AES128/3DES
- 128bit: AES256/AES128
- 192bit: AES256
- 256bit: AES256

## CA-signed Certificate is expired.

### Solutions

If there is a problem with the expiration date of the certificate, "The certificate has expired" is displayed when connecting to Web Config with SSL/TLS communication (https). If the message appears before its expiration date, make sure that the printer's date is configured correctly.

## The common name of the certificate and the printer do not match.

### Solutions

If the common name of the certificate and the printer do not match, the message "The name of the security certificate does not match..." is displayed when accessing Web Config using SSL/TLS communication (https). This happens because the following IP addresses do not match.

- The printer's IP address entered to common name for creating a Self-signed Certificate or CSR
- IP address entered to web browser when running Web Config

For Self-signed Certificate, update the certificate.

For CA-signed Certificate, take the certificate again for the printer.

## The proxy server setting of local address is not set to web browser.

### Solutions

When the printer is set to use a proxy server, configure the web browser not to connect to the local address via the proxy server.

- Windows:

Select **Control Panel > Network and Internet > Internet Options > Connections > LAN settings > Proxy server**, and then configure not to use the proxy server for LAN (local addresses).

- Mac OS:

Select **System Preferences > Network > Advanced > Proxies**, and then register the local address for **Bypass proxy settings for these Hosts & Domains**.

Example:

192.168.1.\*: Local address 192.168.1.XXX, subnet mask 255.255.255.0

192.168.\*.\*: Local address 192.168.XXX.XXX, subnet mask 255.255.0.0

---

# Loading Paper

Paper Handling Precautions. . . . .	140
Paper Size and Type Settings. . . . .	140
Loading Paper. . . . .	142
Loading Various Paper. . . . .	142

## Paper Handling Precautions

- ❑ Read the instruction sheets supplied with the paper.
- ❑ To achieve high-quality printouts with genuine Epson paper, use the paper in the environment stated on the sheets supplied with the paper.
- ❑ Fan and align the edges of the paper before loading. Do not fan or curl photo paper. Doing so may damage the printable side.

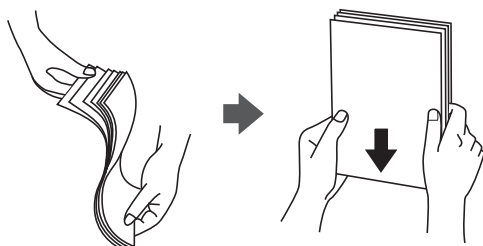

- ❑ If the paper is curled or folded, flatten it or curl it slightly in the opposite direction before loading. Printing on curled or folded paper may cause paper feeding problems and smears on the printouts.

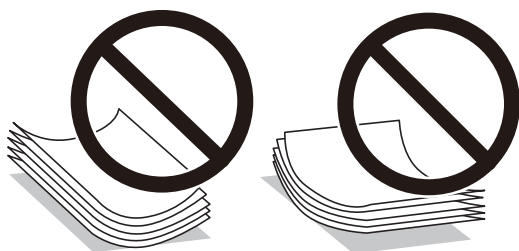

- ❑ Paper feed problems may occur frequently for manual 2-sided printing when printing on one side of pre-printed paper. Reduce the number of sheets to half or less, or load one sheet of paper at a time if paper jams continue.
- ❑ Fan and align the edges of the envelopes before loading. When the stacked envelopes are puffed up with air, press them down to flatten them before loading.



### Related Information

- ➔ [“Available Paper and Capacities” on page 344](#)
- ➔ [“Unavailable Paper Types” on page 347](#)

---

## Paper Size and Type Settings

Make sure that you register the paper size and type on the screen displayed when you load paper. The printer informs you when the registered information and print settings differ. This prevents you from wasting paper and



ink by making sure you are not printing on the wrong paper size or printing using poor print quality due to settings that do not match the paper type.

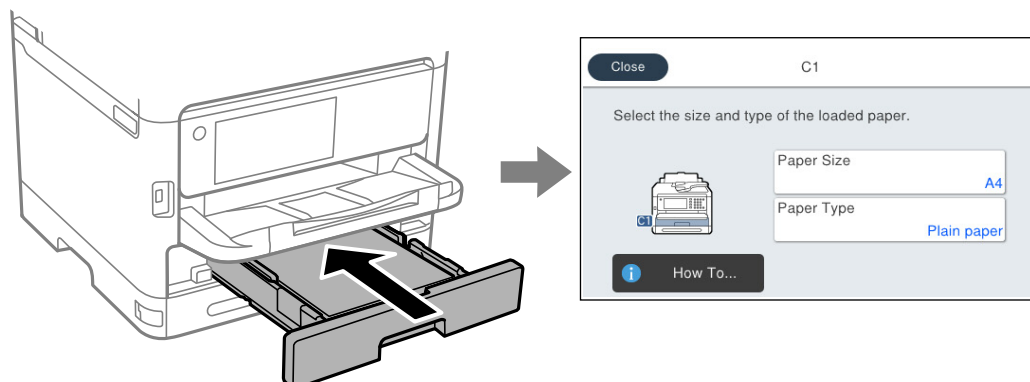

If the paper size and type displayed differ from the loaded paper, select the item you want to change. If the settings match the loaded paper, close the screen.

**Note:**

If you do not want to display the paper settings screen automatically when you load paper, select the menus on the home screen as described below.

**Settings > General Settings > Printer Settings > Paper Source Settings > Paper Setup Auto Display > Off**

**Related Information**

➔ [“Paper Setup Auto Display:” on page 362](#)

## List of Paper Type

To obtain optimum printing results, select the paper type that suits the paper.

Media Name	Media Type			
	Control Panel	Printer Driver, Smart device*	PostScript Printer Driver	Epson Universal Printer Driver
Epson Bright White Ink Jet Paper Epson Business Paper	Plain paper	Plain paper	Plain	Plain
Epson Matte Paper-Heavyweight Epson Double-Sided Matte Paper	Matte	Epson Matte	Epson Matte	-
Epson Photo Quality Ink Jet Paper	Photo Quality Ink Jet	Epson Photo Quality Ink Jet	Epson Photo Quality Ink Jet	-
Thick paper (91 to 160 g/m <sup>2</sup> )	Thick paper1	Thick paper1	Thick1	Thick-Paper1

Media Name	Media Type			
	Control Panel	Printer Driver, Smart device*	PostScript Printer Driver	Epson Universal Printer Driver
Thick paper (161 to 256 g/m <sup>2</sup> )	Thick paper2	Thick paper2	Thick2	Thick-Paper2

\* For smart devices, these media types can be selected when printing using Epson Smart Panel.

## Loading Paper

You can load paper or envelopes by referring to the animations displayed on the printer's LCD screen.

Select , and then select **How To... > Load paper**.

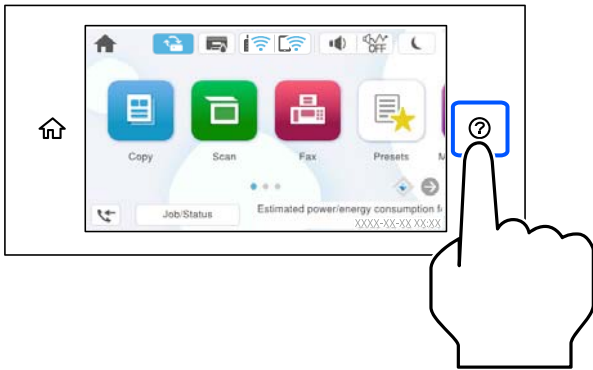

Select the paper type and paper source you want to use to display the animations.

Select **Finish** to close the animation screen.

## Loading Various Paper

### Loading Pre-punched Paper

Load a single sheet of pre-punched paper in the paper tray.

Paper size: A4, B5, A5, A6, Letter, Legal

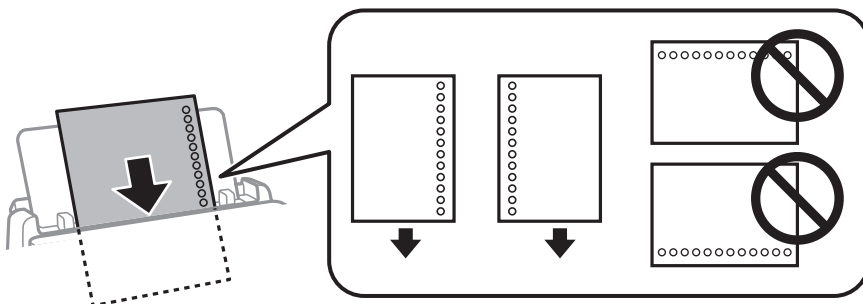

- Adjust the print position of your file to avoid printing over the holes.
- Automatic 2-sided printing is not available for pre-punched paper.

#### Related Information

- ➔ [“Available Paper and Capacities” on page 344](#)
- ➔ [“Unavailable Paper Types” on page 347](#)

## Loading Long Papers

Load long paper in the paper tray by allowing the leading edge of the paper to roll over. Select **User defined** as the paper size setting.

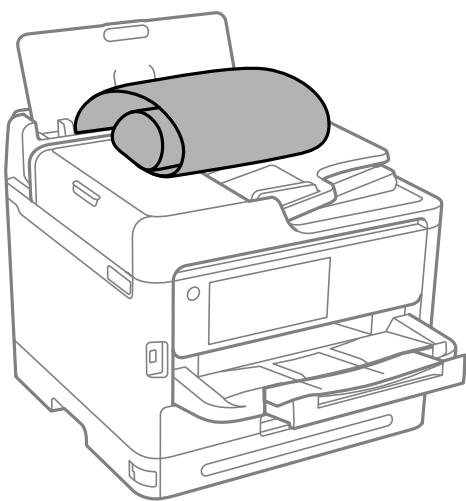

- Make sure the end of the paper is cut perpendicularly. A diagonal cut may cause paper feed problems.
- Long paper cannot be held in the output tray. Prepare a box and so on to make sure that paper does not fall on the floor.
- Do not touch paper that is being fed or ejected. It could injure your hand or cause print quality to decline.

#### Related Information

- ➔ [“Available Paper and Capacities” on page 344](#)
- ➔ [“Unavailable Paper Types” on page 347](#)

---

# Placing Originals

Placing Originals. . . . .	145
Originals that are not Supported by the ADF. . . . .	146

# Placing Originals

Place originals on the scanner glass or the ADF.

You can place multiple originals in the ADF. If auto duplex scanning is available, you can scan both sides of the originals at the same time. See the link below for the specifications of the ADF.

[“ADF Specifications” on page 394](#)

Follow the steps below to view the video for placing originals.

Select , and then select **How To... > Place Originals**. Select the method of placing originals that you want to view. Select **Finish** to close the animation screen.

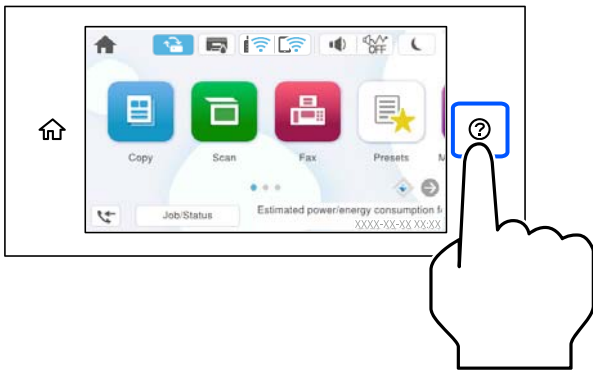

## When using the scanner glass



### Caution:

*Be careful not to trap your fingers when closing the document cover. Otherwise you may be injured.*



### Important:

- When placing bulky originals such as books, prevent exterior light from shining directly onto the scanner glass.
- Do not apply too much force to the scanner glass or the document cover. Otherwise, they may be damaged.

### Note:

- If there is any trash or dirt on the scanner glass, the scanning range may expand to include it, so the image of the original may be displaced or reduced. Remove any trash and dirt on the scanner glass before scanning.

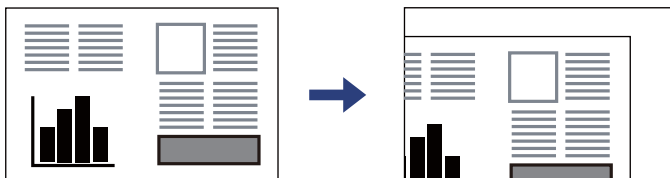

- A range of 1.5 mm from the corner of the scanner glass is not scanned.
- When originals are placed in the ADF and on the scanner glass, priority is given to the originals in the ADF.
- If you leave the originals on the scanner glass for a long time, they may stick to the surface of the glass.

## When using the ADF

**!** *Important:*

- ❑ *Do not load originals above the line just under the triangle symbol inside the ADF edge guide.*

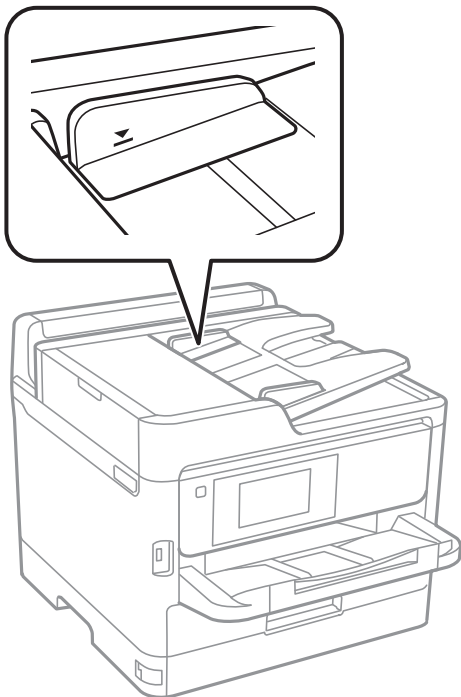

- ❑ *Do not add originals while scanning.*

### Related Information

- ➔ [“Scanner Specifications” on page 393](#)
- ➔ [“Originals that are not Supported by the ADF” on page 146](#)

---

## Originals that are not Supported by the ADF

**!** *Important:*

*Do not feed photographs or valuable original artwork into the ADF. Misfeeding may wrinkle or damage the original. Scan these documents on the scanner glass instead.*

To prevent paper jams, avoid placing the following originals in the ADF. For these types, use the scanner glass.

- ❑ Originals that are torn, folded, wrinkled, deteriorated, or curled
- ❑ Originals with binder holes
- ❑ Originals held together with tape, staples, paper clips etc.
- ❑ Originals that have stickers or labels stuck to them
- ❑ Originals that are cut irregularly or not right angled
- ❑ Originals that are bound

- ❑ OHPs, thermal transfer paper, or carbon backs

---

# Inserting and Removing a Memory Device

Inserting an External USB Device. . . . .	149
Removing an External USB Device. . . . .	149
Sharing Data on a Memory Device. . . . .	149



## Inserting an External USB Device

Insert an external USB device into the external interface USB port.

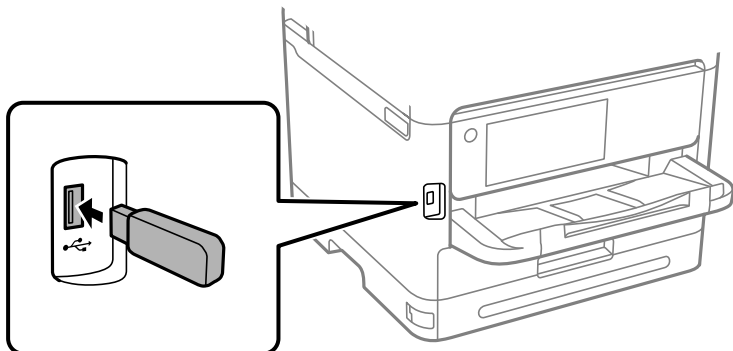

### Related Information

➔ [“Memory Device Specifications” on page 401](#)

## Removing an External USB Device

Remove the external USB device.

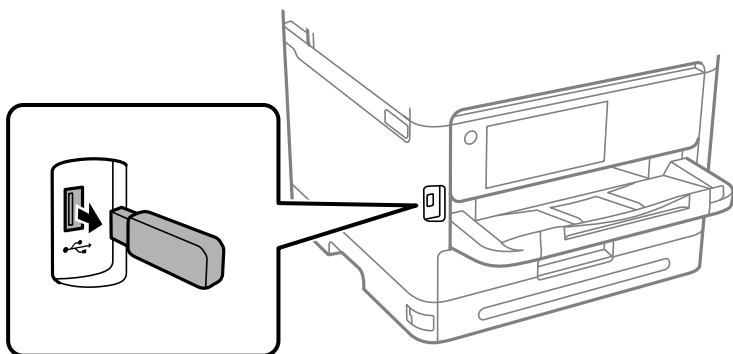

### **Important:**

*If you remove the external USB device while operating the printer, the data on the external USB device may be lost.*

## Sharing Data on a Memory Device

From a computer, you can write or read data on a memory device such as a USB flash drive that has been connected to the printer.

 **Important:**

When sharing a memory device inserted in the printer between computers connected by USB or over a network, write access is only allowed to the computers that are connected by the method you selected on the printer. To write to the memory device, enter **Settings > General Settings > Printer Settings > Memory Device Interface > File Sharing** on the control panel and then select a connection method.

**Note:**

It takes a while to recognize data from a computer if a large memory device, such as 2 TB HDD, is connected.

### Windows

Select a memory device from **PC** or **Computer**. The data on the memory device is displayed.

**Note:**

If you connected the printer to the network without using the software disc or Web Installer, map an external interface USB port as a network drive. Open **Run** and enter a printer name \\XXXXX or a printer's IP address \\XXX.XXX.XXX.XXX to **Open**. Right-click a device icon displayed to assign the network. The network drive appears in **PC** or **Computer**.

### Mac OS

Select a corresponding device icon. The data on the external storage device is displayed.

**Note:**

- To remove a memory device, drag and drop the device icon to the trash icon. Otherwise, data on the shared drive may not be displayed correctly when another memory device is inserted.
- To access a memory device through the network, select **Go > Connect to Server** from the menu on the desktop. Enter a printer name `cifs://XXXXX` or `smb://XXXXX` (Where "XXXXX" is the printer name) in the **Server Address**, and then click **Connect**.

### Related Information

➔ [“Memory Device Specifications” on page 401](#)

---

# Printing

Printing Documents. . . . .	152
Printing on Envelopes. . . . .	191
Printing Photos. . . . .	192
Printing Web Pages. . . . .	194
Printing Using a Cloud Service. . . . .	195
Interrupting and Printing. . . . .	195

## Printing Documents

### Printing from a Computer - Windows

If you cannot change some of the printer driver settings, they may have been restricted by the administrator. Contact your printer administrator for assistance.

### Printing Using Easy Settings

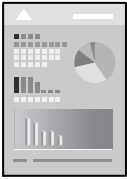

**Note:**

*Operations may differ depending on the application. See the application's help for details.*

1. Load paper in the printer.  
[“Loading Paper” on page 142](#)
2. Open the file you want to print.
3. Select **Print** or **Print Setup** from the **File** menu.
4. Select your printer.

5. Select **Preferences** or **Properties** to access the printer driver window.

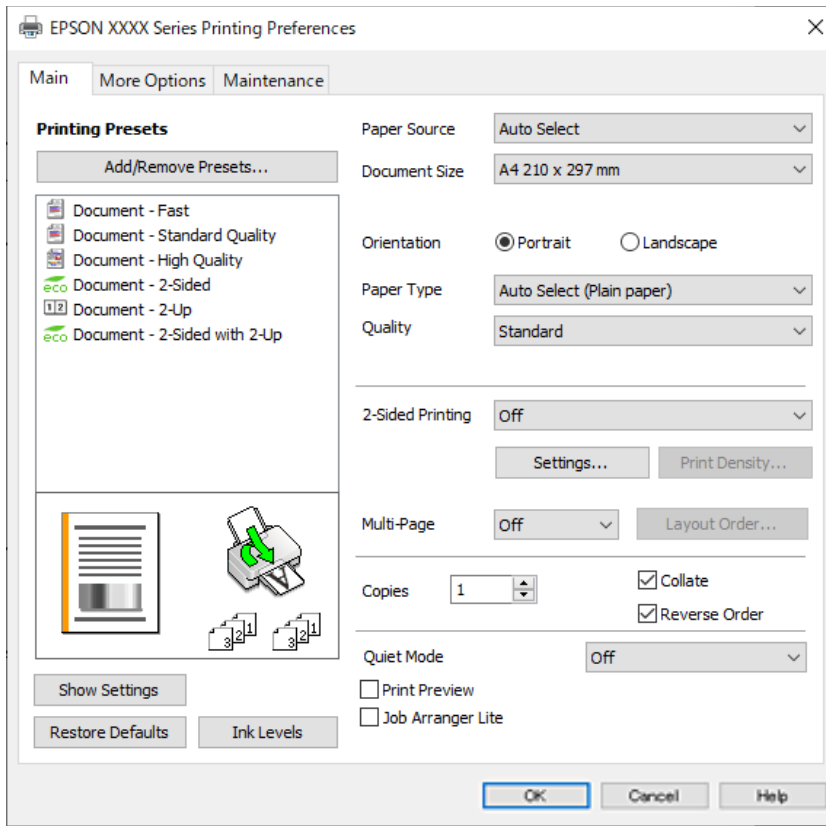

6. Change the settings as necessary.

See the menu options for the printer driver for details.

**Note:**

- You can also see the online help for explanations of the setting items. Right-clicking an item displays **Help**.
- When you select **Print Preview**, you can see a preview of your document before printing.

7. Click **OK** to close the printer driver window.

8. Click **Print**.

**Note:**

- When you select **Print Preview**, a preview window is displayed. To change the settings, click **Cancel**, and then repeat the procedure from step 3.
- If you want to cancel printing, on your computer right-click on your printer in **Devices and Printers**, **Printer**, or in **Printers and Faxes**. Click **See what's printing**, right-click on the job you want to cancel, and then select **Cancel**. However, you cannot cancel a print job from the computer once it has been completely sent to the printer. In this case, cancel the print job by using the printer's control panel.

**Related Information**

- ➔ [“Available Paper and Capacities” on page 344](#)
- ➔ [“List of Paper Type” on page 141](#)
- ➔ [“Menu Options for the Printer Driver” on page 154](#)

## **Menu Options for the Printer Driver**

Open the print window in an application, select the printer, and then access the printer driver window.

### **Note:**

*Menus vary depending on the option you selected.*

## **Main Tab**

### Printing Presets:

#### Add/Remove Presets:

You can add or remove your own presets for frequently used print settings. Select the preset you want to use from the list.

### Show Settings/Hide Settings:

Displays a list of items currently set on the **Main** and **More Options** tabs. You can show or hide the current setting list screen.

### Restore Defaults:

Return all settings to their factory default values. The settings on the **More Options** tab are also reset to their defaults.

### Ink Levels:

Displays the approximate ink level.

### Paper Source:

Select the paper source from which the paper is fed. Select **Auto Select** to automatically select the paper source selected in the print settings on the printer.

### Document Size:

Select the paper size on which you want to print. If you select **User-Defined**, enter the paper width and height, and then register the size.

### Orientation:

Select the orientation you want to use to print.

### Paper Type:

Select the type of paper on which you print.

### Quality:

Select the print quality you want to use for printing. Available settings depend on the paper type you select. Selecting **High** provides higher quality printing, but the printing speed may be slower.

### 2-Sided Printing:

Allows you to perform 2-sided printing.

### Settings:

You can specify the binding edge and the binding margins. When printing multi-page documents, you can select to print starting from either the front or the back side of the page.

**Print Density:**

Select the document type to adjust the print density. If the appropriate print density is selected, you can prevent images from bleeding through to the reverse side. Select **User-Defined** to adjust the print density manually.

**Multi-Page:**

Allows you to print several pages on one sheet or perform poster printing. Click **Layout Order** to specify the order in which pages are printed.

**Copies:**

Set the number of copies you want to print.

**Collate:**

Prints multi-page documents collated in order and sorted into sets.

**Reverse Order:**

Allows you to print from the last page so that the pages are stacked in the correct order after printing.

**Quiet Mode:**

Reduces the noise the printer makes. However, enabling this may reduce print speed.

**Print Preview:**

Displays a preview of your document before printing.

**Job Arranger Lite:**

Job Arranger Lite allows you to combine several files created by different applications and print them as a single print job.

## **More Options Tab**

**Printing Presets:**

**Add/Remove Presets:**

You can add or remove your own presets for frequently used print settings. Select the preset you want to use from the list.

**Show Settings/Hide Settings:**

Displays a list of items currently set on the **Main** and **More Options** tabs. You can show or hide the current setting list screen.

**Restore Defaults:**

Return all settings to their factory default values. The settings on the **Main** tab are also reset to their defaults.

**Document Size:**

Select the paper size on which you want to print.

#### Output Paper:

Select the paper size on which you want to print. If the **Document Size** differs from the **Output Paper, Reduce/Enlarge Document** is selected automatically. You do not have to select it when printing without reducing or enlarging the size of a document.

#### Reduce/Enlarge Document:

Allows you to reduce or enlarge the size of a document.

#### Fit to Page:

Automatically reduce or enlarge the document to fit to the paper size selected in **Output Paper**.

#### Zoom to:

Prints with a specific percentage.

#### Center:

Prints images in the center of the paper.

#### Tone Correction:

##### Automatic:

Adjusts the tone of images automatically.

##### Custom:

Allows you to perform manual tone correction. Click **Advanced** for further settings.

#### Image Options:

Enables print quality options such as Emphasize Text. You can also thicken thin lines to make them visible on the printouts.

#### Watermark Features:

Allows you to make settings for anti-copy patterns, watermarks, or headers and footers.

##### Add/Delete:

Allows you to add or remove any anti-copy patterns or watermarks that you want to use.

##### Settings:

Allows you to set the printing method for anti-copy patterns or watermarks.

##### Header/Footer:

You can print information such as a user name and printing date in headers or footers. You can then set font, size, or style.

#### Confidential Job:

Password-protect confidential documents when printing. If you use this feature, the print data is stored in the printer and can only be printed after the password has been entered using the printer's control panel. Click **Settings** to change the settings.



#### Additional Settings:

##### Rotate 180°:

Rotates pages 180 degrees before printing. Select this item when printing on paper such as envelopes that are loaded in fixed direction in the printer.

##### Bidirectional Printing:

Prints when the print head moves in both directions. The print speed is faster, but the quality may decline.

##### Mirror Image:

Inverts the image so that it prints as it would appear in a mirror.

### Maintenance Tab

#### Print Head Nozzle Check:

Prints a nozzle check pattern to check if the print head nozzles are clogged.

#### Print Head Cleaning:

Cleans the clogged nozzles in the print head. Because this feature uses some ink, clean the print head only if the nozzle is clogged. Print a nozzle check pattern and then select **Clean**.

#### Job Arranger Lite:

Opens the Job Arranger Lite window. Here you can open and edit previously saved data.

#### EPSON Status Monitor 3:

Opens the EPSON Status Monitor 3 window. Here you can confirm the status of the printer and the consumables.

#### Monitoring Preferences:

Allows you to make settings for items on the EPSON Status Monitor 3 window.

#### Extended Settings:

Allows you to make a variety of settings. Right-click each item to view the Help for more details.

#### Print Queue:

Displays the jobs waiting to be printed. You can check, pause, or resume print jobs.

#### Printer and Option Information:

You can register user accounts. If access control is set on the printer, you must register your account.

#### Language:

Changes the language to be used on the printer driver window. To apply the settings, close the printer driver, and then open it again.

#### Software Update:

Starts EPSON Software Updater to check for the latest version of applications on the Internet.

### Technical Support:

If the manual is installed on your computer, the manual is displayed. If it is not installed, you can connect to the Epson Web site to check the manual and available technical support.

## Adding Printing Presets for Easy Printing

If you create your own preset of frequently used print settings on the printer driver, you can print easily by selecting the preset from the list.

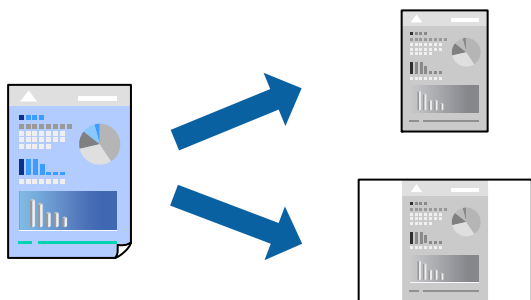

1. On the printer driver's **Main** or **More Options** tab, set each item (such as **Document Size** and **Paper Type**).
2. Click **Add/Remove Presets** in **Printing Presets**.
3. Enter a **Name** and, if necessary, enter a comment.
4. Click **Save**.

**Note:**

To delete an added preset, click **Add/Remove Presets**, select the preset name you want to delete from the list, and then delete it.

[“Main Tab” on page 154](#)

[“More Options Tab” on page 155](#)

5. Click **Print**.

The next time you want to print using the same settings, select the registered setting name from **Printing Presets**, and click **OK**.

### Related Information

- ➔ [“Loading Paper” on page 142](#)
- ➔ [“Printing Using Easy Settings” on page 152](#)

## Printing on 2-Sides

You can use either of the following methods to print on both sides of the paper.

- Automatic 2-sided printing

Manual 2-sided printing

When the printer has finished printing the first side, flip the paper over to print on the other side.

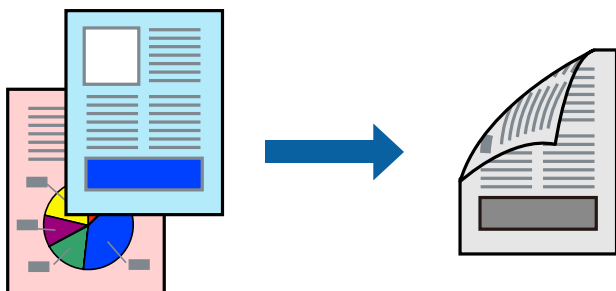

**Note:**

- If you do not use paper that is suitable for 2-sided printing, the print quality may decline and paper jams may occur.  
[“Paper for 2-Sided Printing” on page 346](#)
- Depending on the paper and the data, ink may bleed through to the other side of the paper.
- You cannot perform manual 2-sided printing unless **EPSON Status Monitor 3** is enabled. If **EPSON Status Monitor 3** is disabled, access the printer driver window, click **Extended Settings** on the **Maintenance** tab, and then select **Enable EPSON Status Monitor 3**.
- However, manual 2-sided printing may not be available when the printer is accessed over a network or is used as a shared printer.

1. On the printer driver's **Main** tab, select the method of **2-Sided Printing**.
2. Click **Settings**, make the appropriate settings, and then click **OK**.
3. Click **Print Density**, make the appropriate settings, and then click **OK**.

When setting **Print Density**, you can adjust print density according to the document type.

**Note:**

- This setting is not available when you select manual 2-sided printing.
- Printing may be slow depending on the combination of options selected for **Select Document Type** in the **Print Density Adjustment** window and for **Quality** on the **Main** tab.

4. Set the other items on the **Main** and **More Options** tabs as necessary, and then click **OK**.

[“Main Tab” on page 154](#)

[“More Options Tab” on page 155](#)

5. Click **Print**.

For manual 2-sided printing, when the first side has finished printing, a pop-up window is displayed on the computer. Follow the on-screen instructions.

**Related Information**

- ➔ [“Available Paper and Capacities” on page 344](#)
- ➔ [“Loading Paper” on page 142](#)
- ➔ [“Printing Using Easy Settings” on page 152](#)

## Printing a Booklet

You can also print a booklet that can be created by re-ordering the pages and folding the printout.

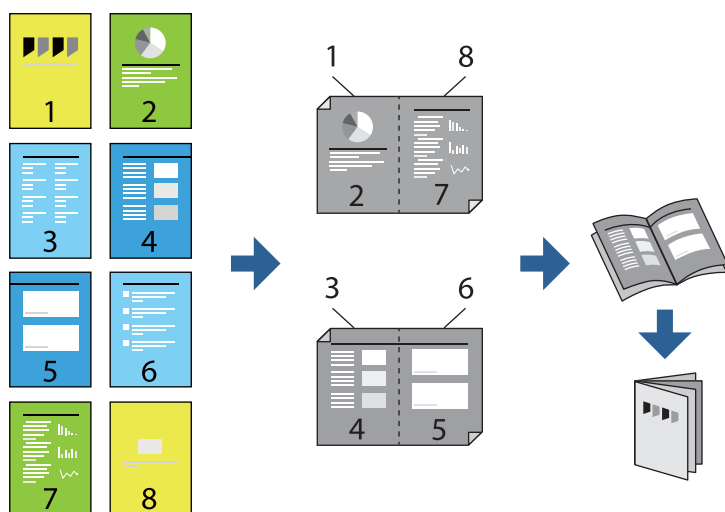

### Note:

- If you do not use paper that is suitable for 2-sided printing, the print quality may decline and paper jams may occur.  
[“Paper for 2-Sided Printing” on page 346](#)
- Depending on the paper and the data, ink may bleed through to the other side of the paper.
- You cannot perform manual 2-sided printing unless **EPSON Status Monitor 3** is enabled. If **EPSON Status Monitor 3** is disabled, access the printer driver window, click **Extended Settings** on the **Maintenance** tab, and then select **Enable EPSON Status Monitor 3**.
- However, manual 2-sided printing may not be available when the printer is accessed over a network or is used as a shared printer.

1. On the printer driver's **Main** tab, select the type of long-edge binding you want to use from **2-Sided Printing**.
2. Click **Settings**, select **Booklet**, and then select **Center Binding** or **Side Binding**.
  - Center Binding:** Use this method when printing a small number of pages that can be stacked and easily folded in half.
  - Side Binding.** Use this method when printing one sheet (four pages) at a time, folding each in half, and then putting them together in one volume.
3. Click **OK**.
4. When printing data that has a lot of photos and images, click **Print Density**, and then make the appropriate settings, and then click **OK**.

When setting **Print Density**, you can adjust print density according to the document type.

### Note:

Printing may be slow depending on the combination of options selected for **Select Document Type** in the **Print Density Adjustment** window and for **Quality** on the **Main** tab.

5. Set the other items on the **Main** and **More Options** tabs as necessary, and then click **OK**.

[“Main Tab” on page 154](#)

[“More Options Tab” on page 155](#)

6. Click **Print**.

### Related Information

- ➔ [“Available Paper and Capacities” on page 344](#)
- ➔ [“Loading Paper” on page 142](#)
- ➔ [“Printing Using Easy Settings” on page 152](#)

## Printing Several Pages on One Sheet

You can print several pages of data on a single sheet of paper.

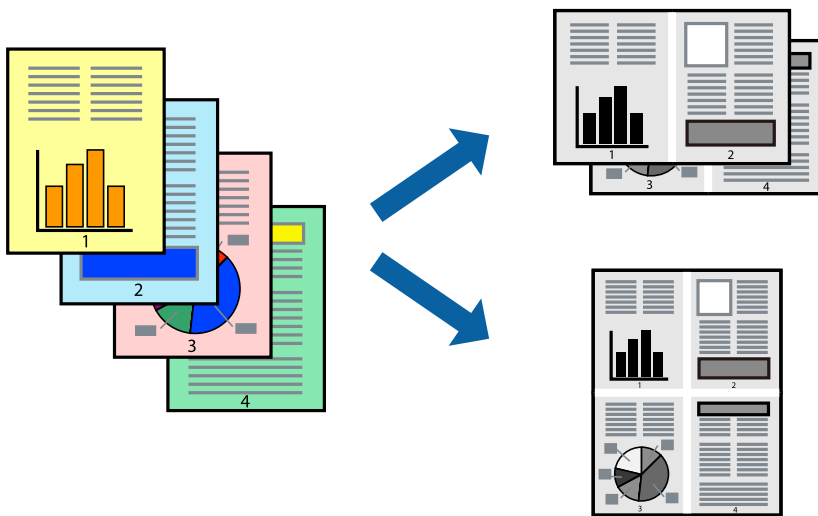

1. On the printer driver's **Main** tab, select **2-Up**, **4-Up**, **6-Up**, **8-Up**, **9-Up**, or **16-Up** as the **Multi-Page** setting.
2. Click **Layout Order**, make the appropriate settings, and then click **OK**.
3. Set the other items on the **Main** and **More Options** tabs as necessary, and then click **OK**.

[“Main Tab” on page 154](#)

[“More Options Tab” on page 155](#)

4. Click **Print**.

### Related Information

- ➔ [“Loading Paper” on page 142](#)
- ➔ [“Printing Using Easy Settings” on page 152](#)

## Printing to Fit the Paper Size

Select the paper size you loaded in the printer as the Destination Paper Size setting.



1. On the printer driver's **More Options** tab, make the following settings.
  - Document Size: Select the size of the paper you set in the application setting.
  - Output Paper: Select the paper size you loaded in the printer.  
**Fit to Page** is automatically selected.

**Note:**

Click **Center** to print the reduced image in the middle of the paper.

2. Set the other items on the **Main** and **More Options** tabs as necessary, and then click **OK**.
  - [“Main Tab” on page 154](#)
  - [“More Options Tab” on page 155](#)
3. Click **Print**.

### Related Information

- ➔ [“Loading Paper” on page 142](#)
- ➔ [“Printing Using Easy Settings” on page 152](#)

## Printing a Reduced or Enlarged Document at any Magnification

You can reduce or enlarge the size of a document by a specific percentage.



1. On the printer driver's **More Options** tab, select the document size from the **Document Size** setting.
2. Select the paper size you want to print on from the **Output Paper** setting.
3. Select **Reduce/Enlarge Document, Zoom to**, and then enter a percentage.  
Select **Center** to print the images in the center of the page.
4. Set the other items on the **Main** and **More Options** tabs as necessary, and then click **OK**.  
[“Main Tab” on page 154](#)  
[“More Options Tab” on page 155](#)
5. Click **Print**.

### Related Information

- ➔ [“Loading Paper” on page 142](#)
- ➔ [“Printing Using Easy Settings” on page 152](#)

## Printing One Image on Multiple Sheets for Enlargement (Creating a Poster)

This feature allows you to print one image on multiple sheets of paper. You can create a larger poster by taping them together.

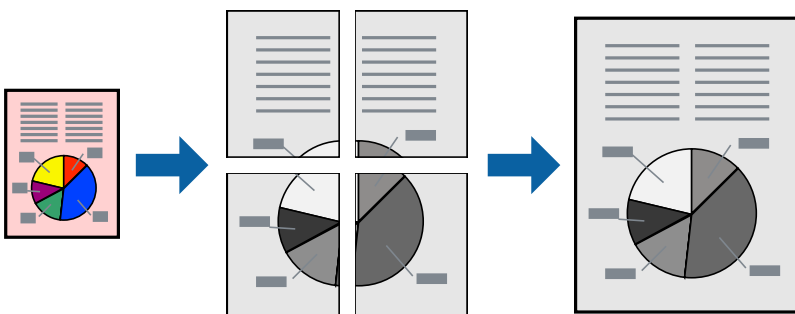

**Note:**

*This feature is not available with 2-sided printing.*

1. On the printer driver's **Main** tab, select **2x1 Poster**, **2x2 Poster**, **3x3 Poster**, or **4x4 Poster** as the **Multi-Page** setting.
2. Click **Settings**, make the appropriate settings, and then click **OK**.

**Note:**

*Print Cutting Guides* allows you to print a cutting guide.

3. Set the other items on the **Main** and **More Options** tabs as necessary, and then click **OK**.

[“Main Tab” on page 154](#)

[“More Options Tab” on page 155](#)

4. Click **Print**.

**Related Information**

➔ [“Loading Paper” on page 142](#)

➔ [“Printing Using Easy Settings” on page 152](#)

**Making Posters Using Overlapping Alignment Marks**

Here is an example of how to make a poster when **2x2 Poster** is selected, and **Overlapping Alignment Marks** is selected in **Print Cutting Guides**.

The actual guides are printed in monochrome, but for this explanation they are shown as blue and red lines.

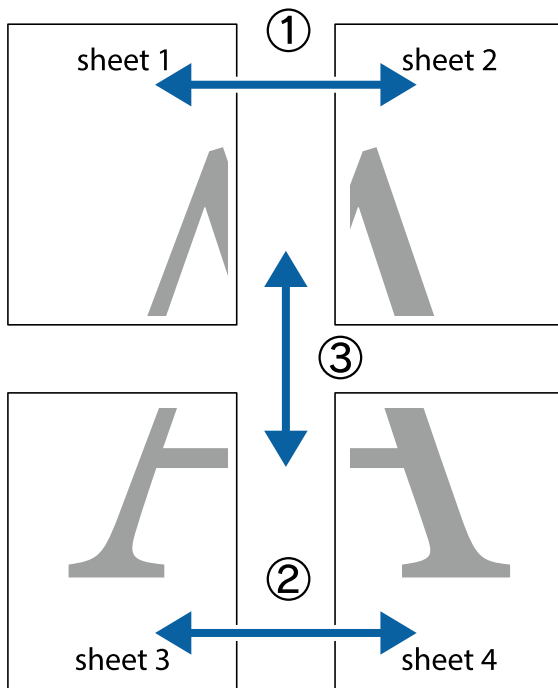



1. Prepare Sheet 1 and Sheet 2. Cut off the margins of Sheet 1 along the vertical blue line through the center of the top and bottom cross marks.

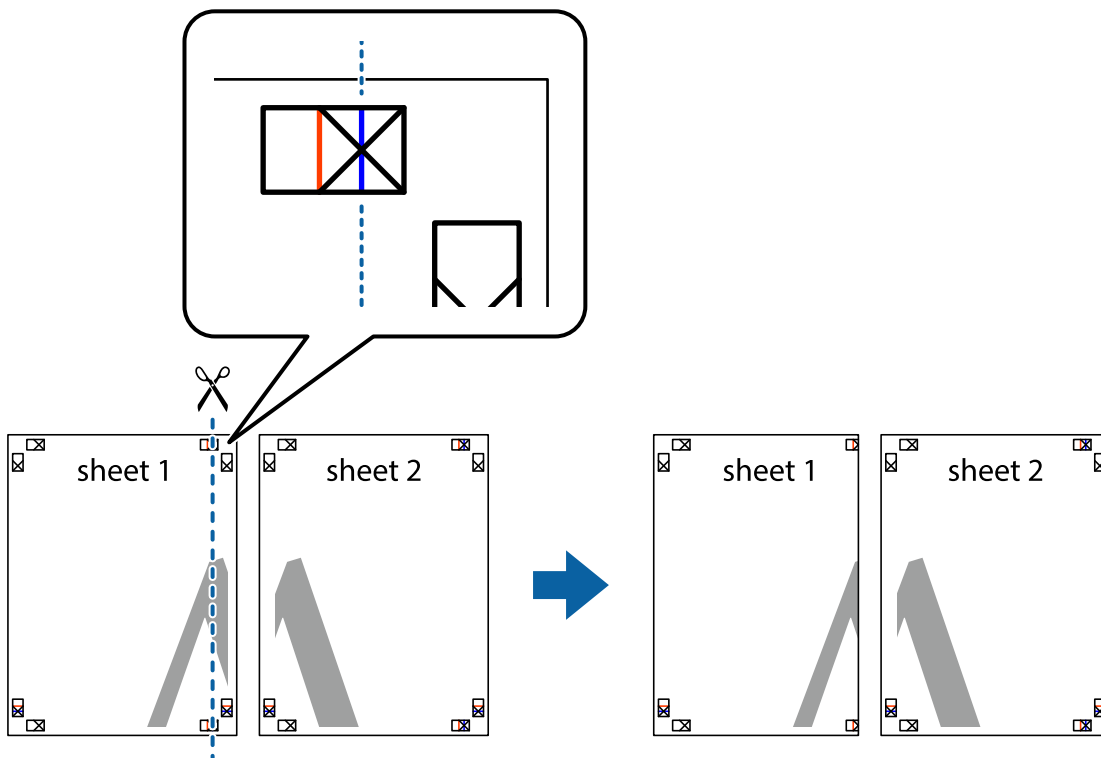

2. Place the edge of Sheet 1 on top of Sheet 2 and align the cross marks, then temporarily tape the two sheets together from the back.

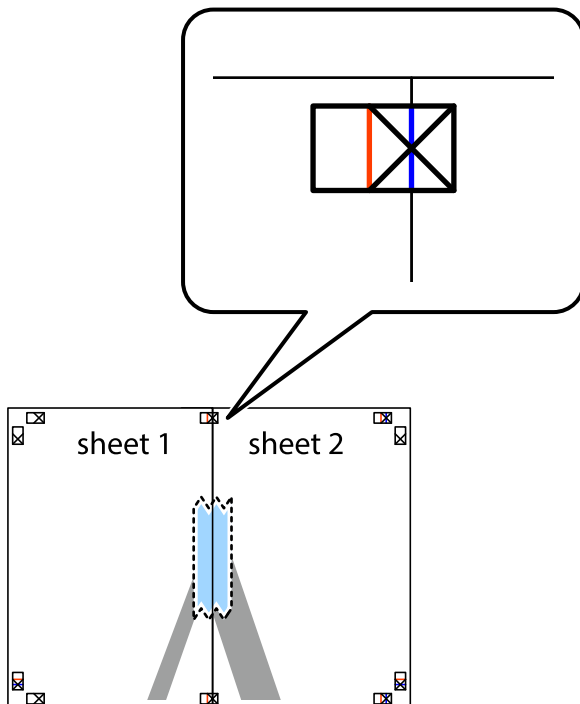

- Cut the taped sheets in two along the vertical red line through the alignment markers (this time, the line to the left of the cross marks).

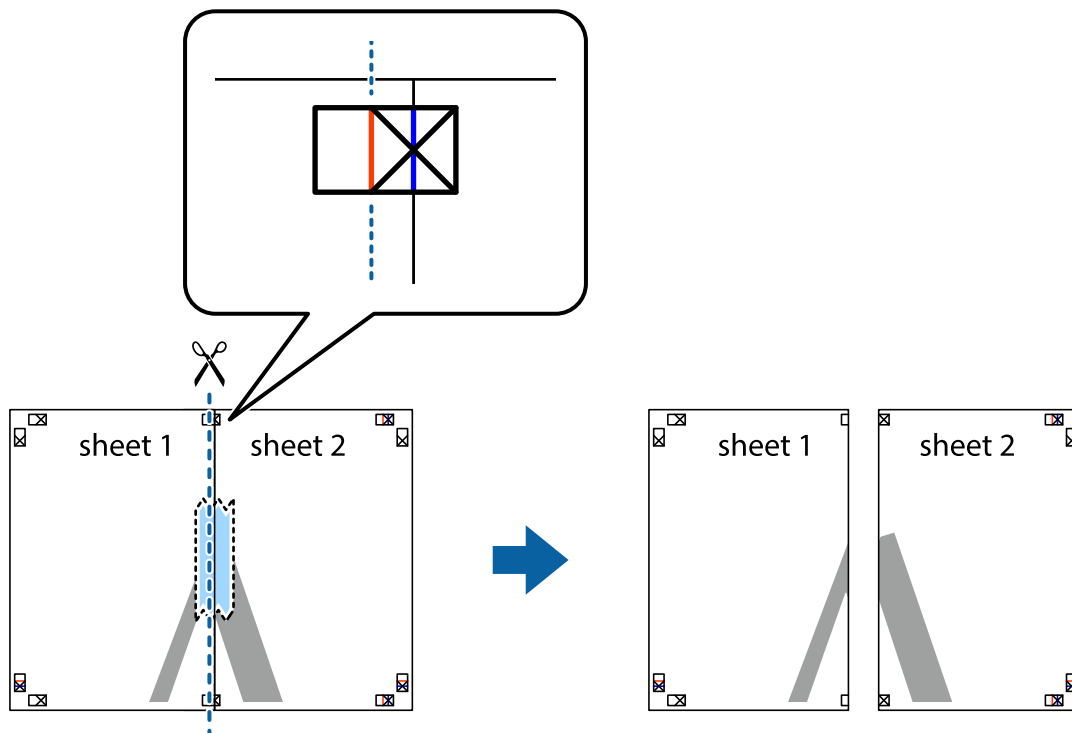

- Tape the sheets together from the back.

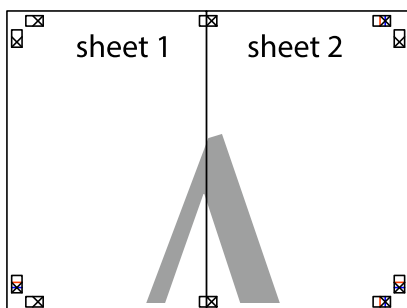

- Repeat steps 1 to 4 to tape Sheet 3 and Sheet 4 together.

- Cut off the margins of Sheet 1 and Sheet 2 along the horizontal blue line through the center of the left and right side cross marks.

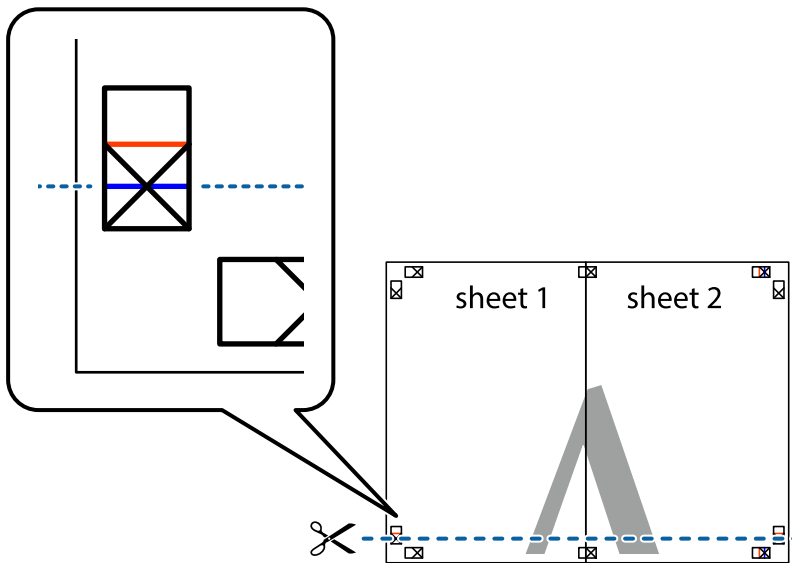

- Place the edge of Sheet 1 and Sheet 2 on top of Sheet 3 and Sheet 4 and align the cross marks, and then temporarily tape them together from the back.

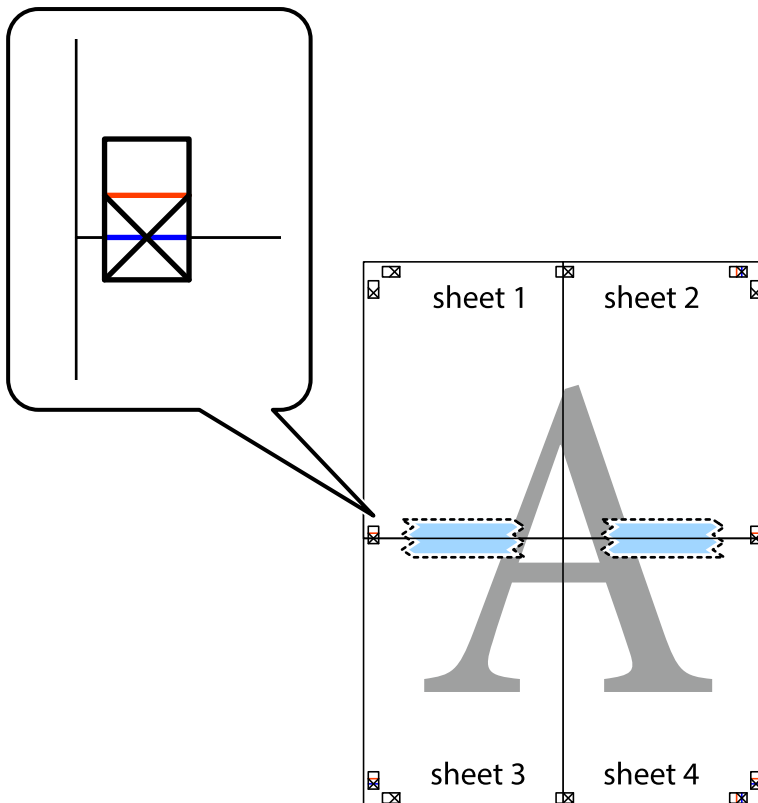

- Cut the taped sheets in two along the horizontal red line through the alignment markers (this time, the line above the cross marks).

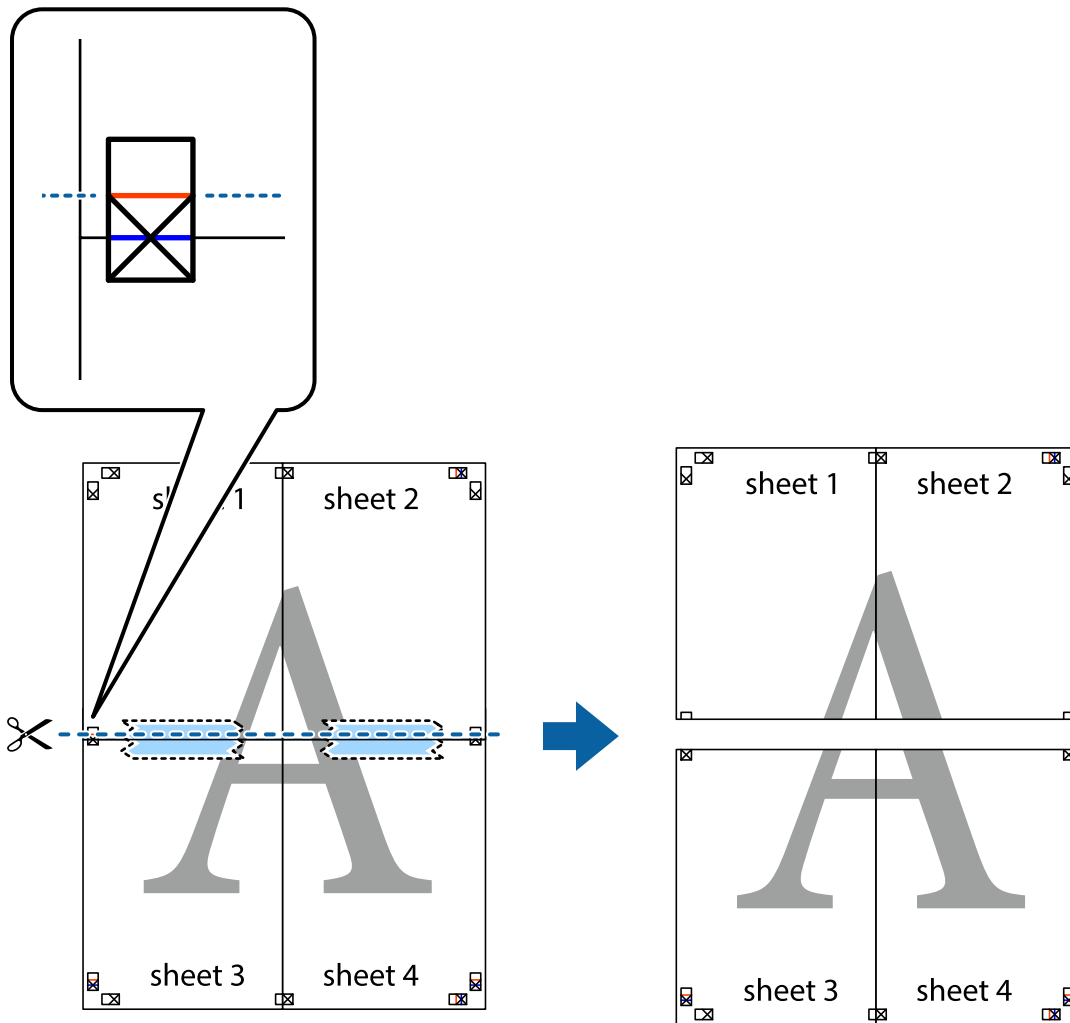

- Tape the sheets together from the back.

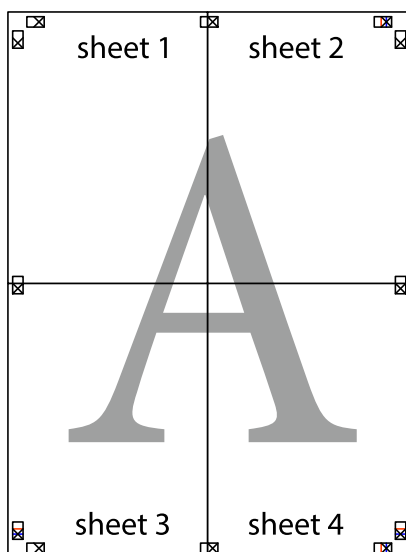

10. Cut off the remaining margins along the outer guide.

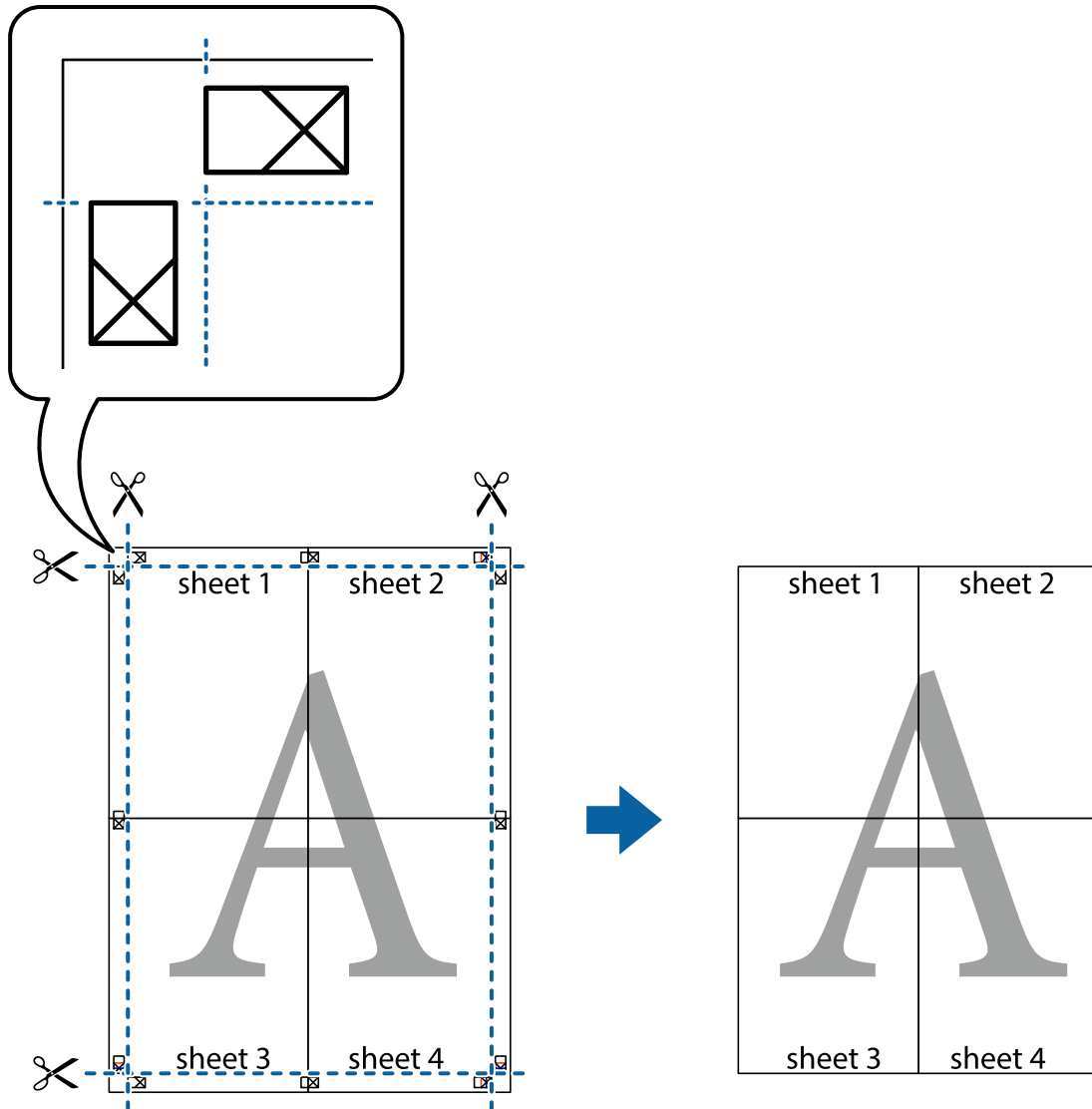

## Printing with a Header and Footer

You can print information such as a user name and printing date in headers or footers.

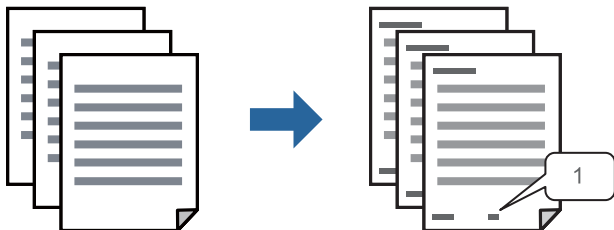

1. On the printer driver's **More Options** tab, click **Watermark Features**, and then select **Header/Footer**.

2. **Settings**, and then select the items you want to print and then click OK.

**Note:**

- To specify the first page number, select **Page Number** from the position you want to print in the header or footer, and then select the number in **Starting number**.
- If you want to print text in the header or footer, select the position you want to print, and then select **Text**. Enter the text you want to print in the text input field.

3. Set the other items on the **Main** and **More Options** tabs as necessary, and then click **OK**.

[“Main Tab” on page 154](#)

[“More Options Tab” on page 155](#)

4. Click **Print**.

### Related Information

- ➔ [“Loading Paper” on page 142](#)
- ➔ [“Printing Using Easy Settings” on page 152](#)

## Printing an Anti-Copy Pattern

You can print an anti-copy pattern on your printouts. When printing, the letters themselves are not printed and the entire print is screen-toned lightly. The hidden letters appear when photocopied to easily distinguish the original from the copies.



Anti-Copy Pattern is available under the following conditions:

- Paper Type: Plain paper, Letterhead, Recycled, Color, Preprinted, High quality plain paper, or Thick paper1
- Quality: Standard
- 2-Sided Printing: Off, Manual (Long-edge binding), or Manual (Short-edge binding)
- Tone Correction: Automatic

**Note:**

*You can also add your own anti-copy pattern.*

1. On the printer driver's **More Options** tab, click **Watermark Features**, and then select Anti-Copy Pattern.
2. Click **Settings** to change details such as the size or density of the pattern.
3. Set the other items on the **Main** and **More Options** tabs as necessary, and then click **OK**.

[“Main Tab” on page 154](#)

[“More Options Tab” on page 155](#)

4. Click **Print**.

### Related Information

- ➔ [“Loading Paper” on page 142](#)
- ➔ [“Printing Using Easy Settings” on page 152](#)

## Printing Password-Protected Job

You can set a password for a print job so that it starts printing only after entering the password on the printer's control panel.

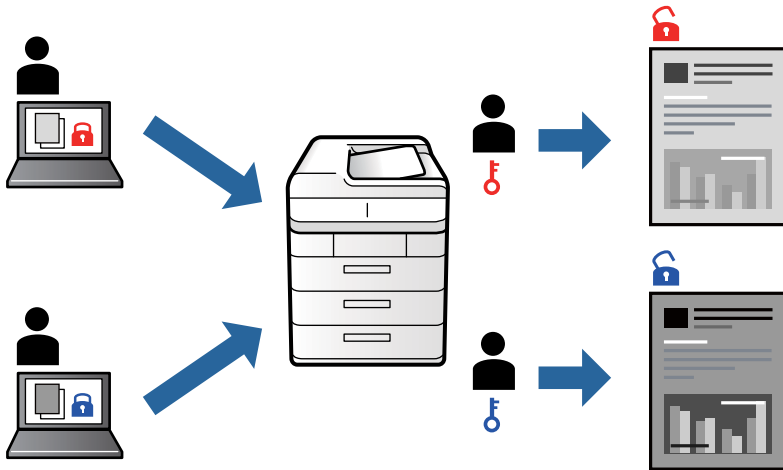

1. On the printer driver's **More Options** tab, select **Confidential Job**, and then enter a password, and click **OK**.
2. Set the other items as necessary, and then click **OK**.
3. Click **Print**.
4. To print the job, select **Print From Internal Memory** on the home screen of the printer's control panel. Select the job you want to print, and then enter the password.

### Related Information

- ➔ [“Loading Paper” on page 142](#)
- ➔ [“Printing Using Easy Settings” on page 152](#)

## Printing Multiple Files Together

Job Arranger Lite allows you to combine several files created by different applications and print them as a single print job. You can specify the print settings for combined files, such as multi-page layout, and 2-sided printing.

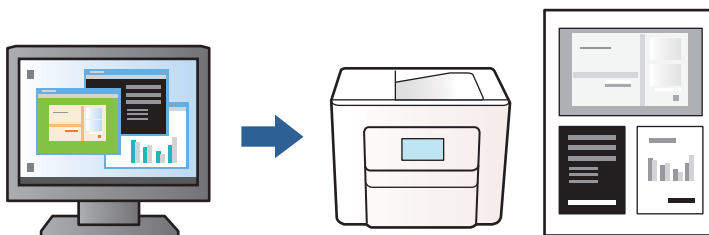

1. On the printer driver's **Main** tab, select **Job Arranger Lite**, and then click **OK**.

[“Main Tab” on page 154](#)

2. Click **Print**.

When you start printing, the Job Arranger Lite window is displayed.

3. With the Job Arranger Lite window opened, open the file that you want to combine with the current file, and then repeat the above steps.

4. When you select a print job added to Print Project in the Job Arranger Lite window, you can edit the page layout.

5. Click **Print** from the **File** menu to start printing.

**Note:**

*If you close the Job Arranger Lite window before adding all the print data to the Print Project, the print job you are currently working on is canceled. Click **Save** from the **File** menu to save the current job. The extension of the saved files is ".ecl".*

*To open a Print Project, click **Job Arranger Lite** on the printer driver's **Maintenance** tab to open the Job Arranger Lite window. Next, select **Open** from the **File** menu to select the file.*

**Related Information**

➔ [“Loading Paper” on page 142](#)

➔ [“Printing Using Easy Settings” on page 152](#)

## Adjusting the Print Tone

You can adjust the tone used in the print job. These adjustments are not applied to the original data.

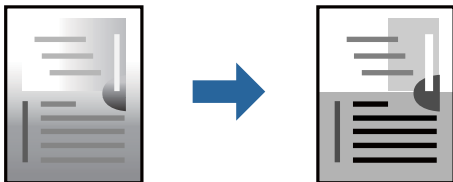

1. On the printer driver's **More Options** tab, select the method of tone correction from the **Tone Correction** setting.

Automatic: This setting automatically adjusts the tone to match the paper type and print quality settings.

Custom: Click **Advanced**, you can make your own settings.

2. Set the other items on the **Main** and **More Options** tabs as necessary, and then click **OK**.

[“Main Tab” on page 154](#)

[“More Options Tab” on page 155](#)

3. Click **Print**.

**Related Information**

➔ [“Loading Paper” on page 142](#)



➔ [“Printing Using Easy Settings” on page 152](#)

## Printing to Emphasize Thin Lines

You can thicken thin lines that are too thin to print.

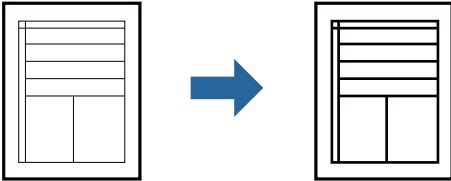

1. On the printer driver's **More Options** tab, click **Image Options** in the **Tone Correction** setting.
2. Select **Emphasize Thin Lines**.
3. Set the other items on the **Main** and **More Options** tabs as necessary, and then click **OK**.  
[“Main Tab” on page 154](#)  
[“More Options Tab” on page 155](#)
4. Click **Print**.

### Related Information

- ➔ [“Loading Paper” on page 142](#)
- ➔ [“Printing Using Easy Settings” on page 152](#)

## Printing Clear Bar Codes

If printed bar codes cannot be read correctly, you can print clearly using reduced ink bleeding. Only enable this feature if the bar code you printed cannot be scanned.

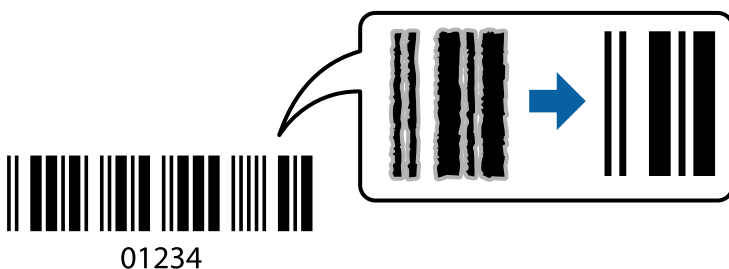

You can use this feature under the following conditions.

- Paper Type: Plain paper, Letterhead, Recycled, Color, Preprinted, High quality plain paper, Thick paper1, Thick paper2, Epson Matte, Epson Photo Quality Ink Jet, or Envelope
- Quality: **Standard**

1. On the printer driver's **Maintenance** tab, click **Extended Settings**, and then select **Barcode mode**.

2. Set the other items on the **Main** and **More Options** tabs as necessary, and then click **OK**.

[“Main Tab” on page 154](#)

[“More Options Tab” on page 155](#)

3. Click **Print**.

**Note:**

*Deblurring may not always be possible depending on the circumstances.*

### Related Information

➔ [“Loading Paper” on page 142](#)

➔ [“Printing Using Easy Settings” on page 152](#)

## Printing a Document Using the PostScript Printer Driver (Windows)

A PostScript Printer Driver is a driver that outputs printing commands to a printer using a PostScript Page Description Language.

1. Open the file you want to print.  
Load paper in the printer if it has not already been loaded.
2. Select **Print** or **Print Setup** from the **File** menu
3. Select your printer.
4. Select **Preferences** or **Properties** to access the printer driver window.

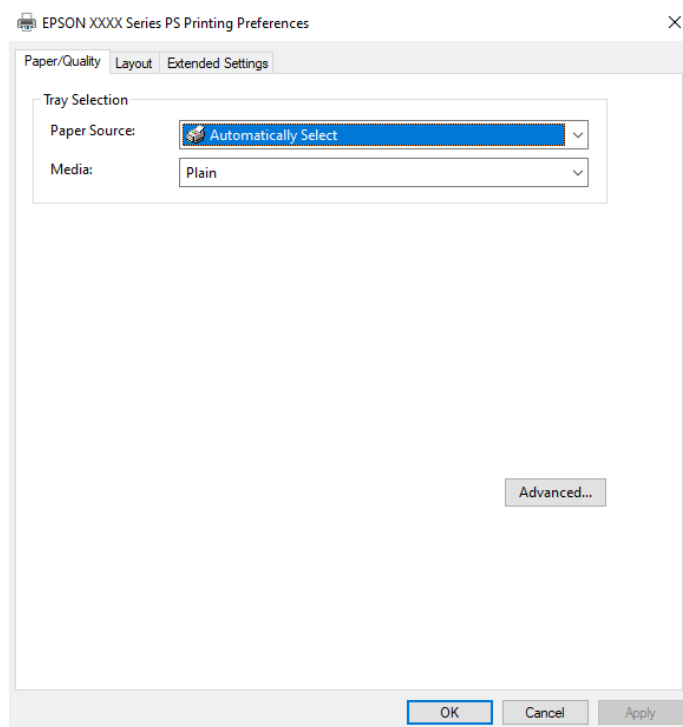

5. Change the settings as necessary.  
See the menu options for the printer driver for details.
6. Click **OK** to close the printer driver for details.
7. Click **Print**.

### **Related Information**

- ➔ [“Available Paper and Capacities” on page 344](#)
- ➔ [“Loading Paper” on page 142](#)
- ➔ [“List of Paper Type” on page 141](#)
- ➔ [“Paper/Quality Tab” on page 175](#)
- ➔ [“Layout Tab” on page 175](#)

## **Menu Options for the PostScript Printer Driver**

Open the print window on an application, select the printer, and then access the printer driver window.

### **Note:**

*Menus vary depending on the option you selected.*

### **Paper/Quality Tab**

#### Tray Selection:

Select the paper source and media.

#### Paper Source:

Select the paper source from which the paper is fed.

Select **Automatically Select** to automatically select the paper source selected in the **Paper Setting** on the printer.

#### Media:

Select the type of paper on which you print. If you select **Unspecified**, printing is performed from the paper source for which the paper type is set to the following in the printer's settings.

Plain paper, Recycled, High quality plain paper

However, paper cannot be fed from a paper source for which the paper source is set to off in the printer's **Auto Select Settings**.

### **Layout Tab**

#### Orientation:

Select the orientation you want to use to print.

#### Print on Both Sides:

Allows you to perform 2-sided printing.

**Page Order:**

Select to print from the top or the last page. If you select **Back to Front**, the pages are stacked in the correct order based on page number after printing.

**Page Format:**

**Pages per Sheet:**

Pages per Sheet Layout:

Allows you to specify the page layout when printing several pages on one sheet.

**Booklet:**

Booklet Binding:

Select the binding position for booklet.

**Draw Borders:**

Select this if you want to place a border line for each page when printing several pages on one sheet or when creating a booklet.

***Extended Settings Tab***

**Job Settings:**

If the printer usage has been restricted by the administrator, printing is available after you register your account on the printer driver. Contact the administrator for your user account.

**Save Access Control settings:**

Allows you to enter a user name and password.

**User Name:**

Enter a user name.

**Password:**

Enter a password.

**Reserve Job Settings:**

Make settings for print jobs stored in the printer's memory.

**Confidential Job:**

Select **Confidential Job** and enter the password. The printer will not print until you enter the password on the printer's control panel.

**Password:**

Enter the Confidential Job password.

**User Name:**

Enter a user name.

Job Name:

Enter a job name.

### **Advanced Options**

Paper/Output:

Select the paper size and number of copies.

Paper Size:

Select the paper size on which you want to print.

Copies:

Set the number of copies you want to print.

Graphic:

Set the following menu items.

Print Quality:

Select the print quality you want to use for printing.

Scaling:

Allows you to reduce or enlarge the document.

TrueType Font:

Sets the font substitute to TrueType Font.

Document Options:

Advanced Printing Features:

Allows you to make detailed settings for printing features.

PostScript Options:

Allows you to make optional settings.

Printer Features:

Set the following menu items.

Ink Save Mode:

Conserves ink by reducing the print density.

Rotate by 180°:

Rotates the data 180 degrees before printing.

## Printing from a Computer - Mac OS

### Printing Using Easy Settings

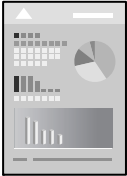

**Note:**

*Operations and screens differ depending on the application. See the application's help for details.*

1. Load paper in the printer .  
[“Loading Paper” on page 142](#)
2. Open the file you want to print.
3. Select **Print** from the **File** menu or another command to access the print dialog.  
If necessary, click **Show Details** or ▼ to expand the print window.
4. Select your printer.

5. Select **Print Settings** from the pop-up menu.

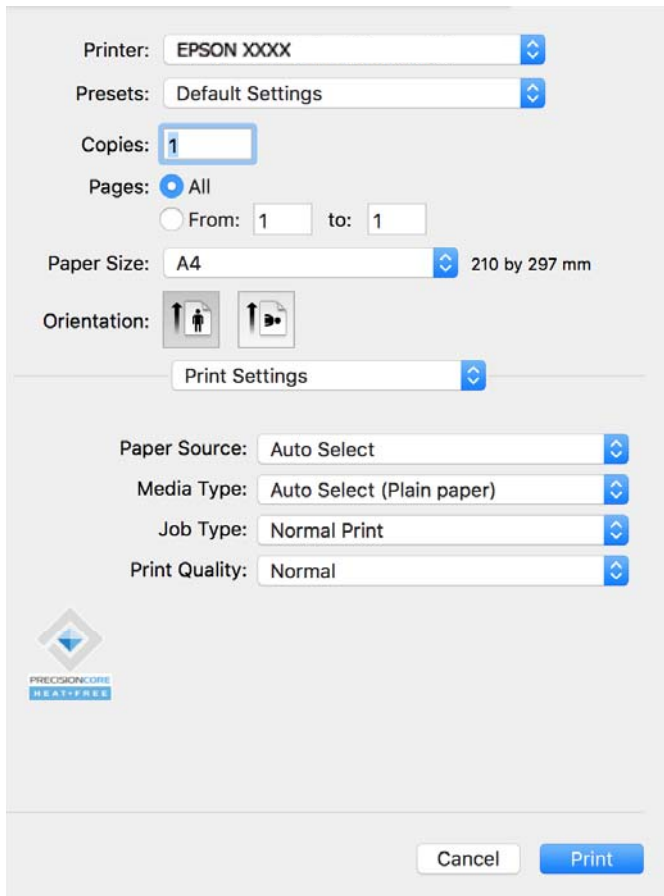

**Note:**

If the **Print Settings** menu is not displayed on macOS Catalina (10.15) or later, macOS High Sierra (10.13), macOS Sierra (10.12), OS X El Capitan (10.11), OS X Yosemite (10.10), OS X Mavericks (10.9), the Epson printer driver has not been installed correctly. Enable it from the following menu.

Select **System Preferences** from the Apple menu > **Printers & Scanners** (or **Print & Scan**, **Print & Fax**), remove the printer, and then add the printer again. See the following to add a printer.

[“Adding a Genuine Epson Printer \(for Mac OS Only\)” on page 276](#)

macOS Mojave (10.14) cannot access **Print Settings** in applications made by Apple such as TextEdit.

6. Change the settings as necessary.  
See the menu options for the printer driver for details.

7. Click **Print**.

**Note:**

If you want to cancel printing, on your computer click the printer icon in the **Dock**. Select the job you want to cancel, and then click  next to the progress meter. However, you cannot cancel a print job from the computer once it has been completely sent to the printer. In this case, cancel the print job by using the printer's control panel.

**Related Information**

- ➔ [“Available Paper and Capacities” on page 344](#)
- ➔ [“List of Paper Type” on page 141](#)

➔ [“Menu Options for Print Settings” on page 181](#)

### **Menu Options for the Printer Driver**

Open the print window in an application, select the printer, and then access the printer driver window.

**Note:**

*Menus vary depending on the option you selected.*

### **Menu Options for Layout**

**Pages per Sheet:**

Select the number of pages to be printed on one sheet.

**Layout Direction:**

Specify the order in which the pages will be printed.

**Border:**

Prints a border around the pages.

**Reverse page orientation:**

Rotates pages 180 degrees before printing. Select this item when printing on paper such as envelopes that are loaded in fixed direction in the printer.

**Flip horizontally:**

Inverts an image to print as it would appear in a mirror.

### **Menu Options for Color Matching**

**ColorSync/EPSON Color Controls:**

Select the method for color adjustment. These options adjust colors between the printer and the computer display to minimize the difference in tone.

### **Menu Options for Paper Handling**

**Collate pages:**

Prints multi-page documents collated in order and sorted into sets.

**Pages to Print:**

Select to print only odd pages or even pages.

**Page Order:**

Select to print from the top or the last page.

**Scale to fit paper size:**

Prints to fit to the paper size you loaded.



Destination Paper Size:

Select the paper size to print on.

Scale down only:

Select this when you want to reduce the size only if the print data is too large for the paper size loaded in the printer.

### Menu Options for Cover Page

Print Cover Page:

Select whether or not to print a cover page. When you want to add a back cover, select **After document**.

Cover Page Type:

Select the contents of the cover page.

### Menu Options for Print Settings

Paper Source:

Select the paper source from which the paper is fed. Select **Auto Select** to automatically select the paper source selected in the print settings on the printer.

Media Type:

Select the type of paper on which you print. If you select **Auto Select (Plain paper)**, printing is performed from the paper source for which the paper type is set to the following in the printer's settings.

Plain paper, Recycled, High quality plain paper

However, paper cannot be fed from a paper source for which the paper source is set to off in the printer's **Auto Select Settings**.

Job Type:

If you select **Confidential Job**, the print data is stored in the printer and can only be printed after the password has been entered using the printer's control panel. Set the password in **Confidential Job Settings** on the Utilities screen.

Print Quality:

Select the print quality you want to use for printing. The options vary depending on the paper type.

### Menu Options for Color Options

You can adjust the brightness and contrast.

### Menu Options for Two-sided Printing Settings

Two-sided Printing:

Prints on both sides of the paper.

## Adding Printing Presets for Easy Printing

If you create your own preset of frequently used print settings on the printer driver, you can print easily by selecting the preset from the list.

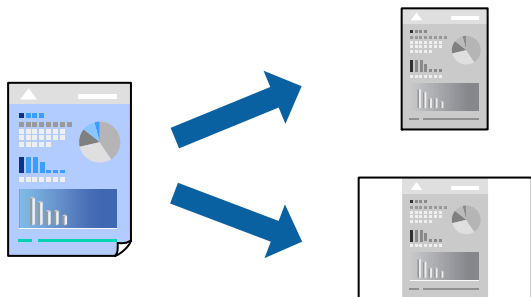

1. Set each item such as **Print Settings** and **Layout (Paper Size, Media Type, and so on)**.
2. Click **Presets** to save the current settings as a preset.
3. Click **OK**.

**Note:**

To delete an added preset, click **Presets > Show Presets**, select the preset name you want to delete from the list, and then delete it.

4. Click **Print**.

The next time you want to print using the same settings, select the registered preset name from the **Presets**.

### Related Information

- ➔ [“Loading Paper” on page 142](#)
- ➔ [“Printing Using Easy Settings” on page 178](#)

## Printing on 2-Sides

You can print on both sides of the paper.

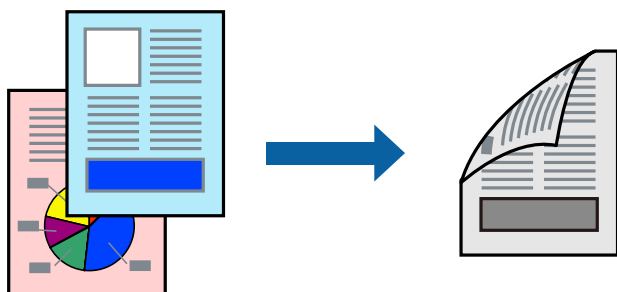

**Note:**

- If you do not use paper that is suitable for 2-sided printing, the print quality may decline and paper jams may occur.  
[“Paper for 2-Sided Printing” on page 346](#)

- Depending on the paper and the data, ink may bleed through to the other side of the paper.

1. Select **Two-sided Printing Settings** from the pop-up menu.

2. Select the bindings in **Two-sided Printing**.
3. Set the other items as necessary.
4. Click **Print**.

### Related Information

- ➔ [“Available Paper and Capacities” on page 344](#)
- ➔ [“Loading Paper” on page 142](#)
- ➔ [“Printing Using Easy Settings” on page 178](#)

## Printing Several Pages on One Sheet

You can print several pages of data on a single sheet of paper.

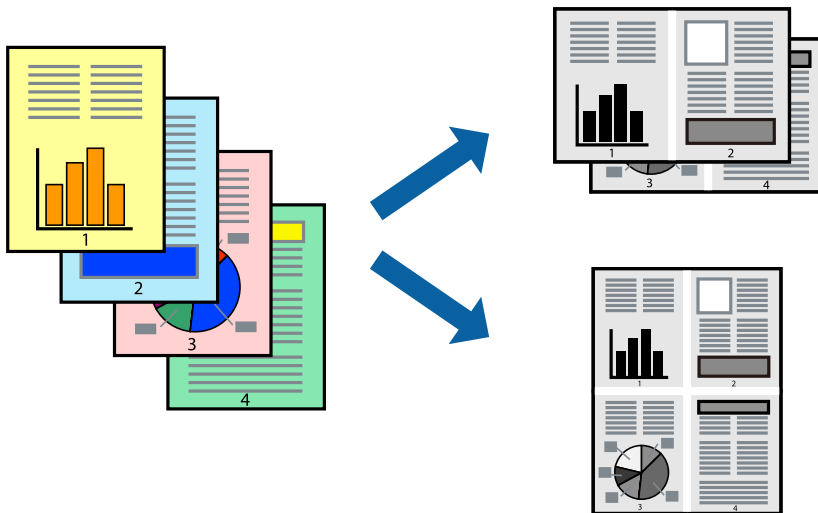

1. Select **Layout** from the pop-up menu.
2. Set the number of pages in **Pages per Sheet**, the **Layout Direction** (page order), and **Border**.  
[“Menu Options for Layout” on page 180](#)
3. Set the other items as necessary.
4. Click **Print**.

### Related Information

- ➔ [“Loading Paper” on page 142](#)
- ➔ [“Printing Using Easy Settings” on page 178](#)

## Printing to Fit the Paper Size

Select the paper size you loaded in the printer as the Destination Paper Size setting.

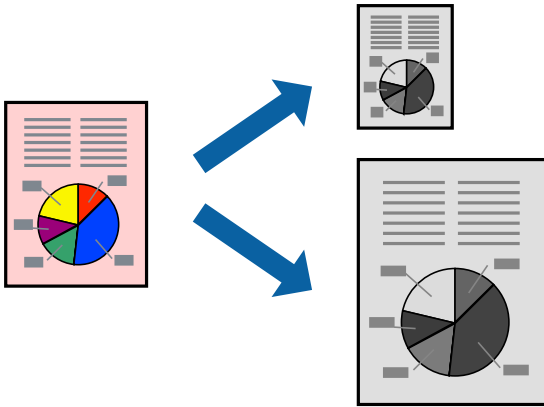

1. Select the size of the paper you set in the application as the **Paper Size** setting.
2. Select **Paper Handling** from the pop-up menu.
3. Select **Scale to fit paper size**.
4. Select the paper size you loaded in the printer as the **Destination Paper Size** setting.
5. Set the other items as necessary.
6. Click **Print**.

### Related Information

- ➔ [“Loading Paper” on page 142](#)
- ➔ [“Printing Using Easy Settings” on page 178](#)

## Printing a Reduced or Enlarged Document at any Magnification

You can reduce or enlarge the size of a document by a specific percentage.



**Note:**

Operations differ depending on the application. See the application's help for details.

1. Do one of the following.
  - Select **Print** from the **File** menu of the application. Click **Page Setup**, and then select your printer in **Format For**. Select the size of the data to be printed from **Paper Size**, enter a percentage in **Scale**, and then click **OK**.
  - Select **Page Setup** from the **File** menu of the application. Select your printer in **Format For**. Select the size of the data to be printed from **Paper Size**, enter a percentage in **Scale**, and then click **OK**. Select **Print** from the **File** menu.
2. Select your printer in **Printer**.
3. Set the other items as necessary.
4. Click **Print**.

**Related Information**

- ➔ [“Loading Paper” on page 142](#)
- ➔ [“Printing Using Easy Settings” on page 178](#)

## Adjusting the Print Tone

You can adjust the tone used in the print job. These adjustments are not applied to the original data.

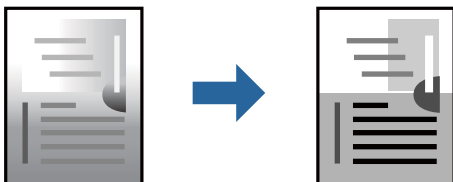

1. Select **Color Options** from the pop-up menu, and then set the brightness and contrast.
2. Set the other items as necessary.
3. Click **Print**.

**Related Information**

- ➔ [“Loading Paper” on page 142](#)
- ➔ [“Printing Using Easy Settings” on page 178](#)

## Printing from the PostScript Printer Driver on Mac OS

A PostScript Printer Driver is a driver that outputs printing commands to a printer using a PostScript Page Description Language.

1. Open the file you want to print.  
Load paper in the printer if it has not already been loaded.

2. Select **Print** or **Print Setup** from the **File** menu.

If necessary, click **Show Details** or ▼ to expand the print window.

3. Select your printer.
4. Select **Print Features** from the pop-up menu.

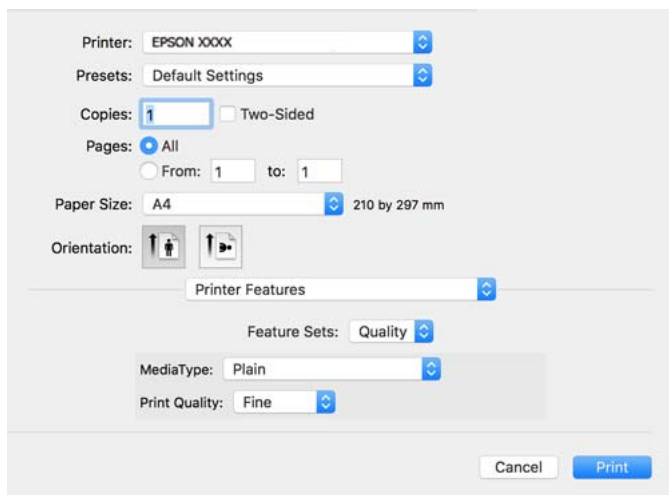

5. Change the settings as necessary.  
See the menu options for the printer driver for details.
6. Click **Print**.

### Related Information

- ➔ [“Available Paper and Capacities” on page 344](#)
- ➔ [“Loading Paper” on page 142](#)
- ➔ [“List of Paper Type” on page 141](#)
- ➔ [“Menu Options for Printer Features” on page 188](#)

## Menu Options for the PostScript Printer Driver

Open the print window on an application, select the printer, and then access the printer driver window.

### Note:

Menus vary depending on the option you selected.

### Menu Options for Layout

#### Pages per Sheet:

Select the number of pages to be printed on one sheet.

#### Layout Direction:

Specify the order in which the pages will be printed.

**Border:**

Prints a border around the pages.

**Two-Sided:**

Allows you to perform 2-sided printing.

**Reverse page orientation:**

Rotates pages 180 degrees before printing.

**Flip horizontally:**

Inverts the image so that it prints as it would appear in a mirror.

### ***Menu Options for Color Matching***

**ColorSync/In Printer:**

Select the method for color adjustment. These options adjust color between the printer and the computer display to minimize the difference in tone.

### ***Menu Options for Paper Handling***

**Collate pages:**

Prints multi-page documents collated in order and sorted into sets.

**Pages to Print:**

Select to print only odd pages or even pages.

**Page Order:**

Select to print from the top or the last page.

**Scale to fit paper size:**

Prints to fit to the paper size you loaded.

**Destination Paper Size:**

Select the paper size to print on.

**Scale down only:**

Select when reducing the size of the document.

### ***Menu Options for Paper Feed***

Select the paper source from which the paper is fed.

**All Pages From:**

Selecting **Auto Select** selects the paper source that matches the **Paper Setting** on the printer automatically.

First Page From/Remaining From:

You can also select the paper source for page.

### ***Menu Options for Cover Page***

Print Cover Page:

Select whether or not to print a cover page. When you want to add a back cover, select **After document**.

Cover Page Type:

Select the contents of the cover page.

### ***Menu Options for Job Settings***

#### **Confidential Job:**

Allows you to enter a password to the print job.

User Name:

Enter a user name.

Job Name:

Enter a job name.

Password:

Enter a password.

### ***Menu Options for Printer Features***

Feature Sets:

Quality:

MediaType:

Select the type of paper on which you print. If you select **Unspecified**, printing is performed from the paper source for which the paper type is set to the following in the printer's settings.

Plain, Recycled, High quality plain paper

However, paper cannot be fed from a paper source for which the paper source is set to off in the printer's **Auto Select Settings**.

Print Quality:

Select the print quality you want to use for printing.



Others:

Ink Save Mode:

Conserves ink by reducing the print density.

## Printing PDF Files from a Memory Device

You can print PDF files from a memory device connected to the printer.

1. Connect the memory device to the printer's external interface USB port.  
[“Inserting an External USB Device” on page 149](#)
2. Select **Memory Device** on the home screen.
3. Select **PDF**.
4. Select the file, and then proceed to the next screen.
5. Tap .

## Basic Menu Options for PDF Settings

 (Display order) :

Changes the order of the files.

Paper Setting:

Specify the paper source settings which you want to print on.

## Advanced Menu Options for PDF Settings

2-Sided:

Select **On** to print PDF files using 2-Sided printing. You can also select the binding method in the **Binding(Copy)** setting.

Print Order:

Select the order for printing multi-page files.

## Printing Documents from Smart Devices

You can print documents from a smart device such as a smartphone or tablet.

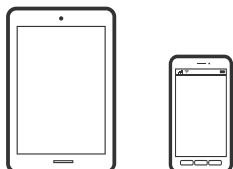

## Printing Using Epson Smart Panel

Epson Smart Panel is an application that allows you to perform printer operations easily including printing, copying, or scanning from a smart device such as a smartphone or tablet. You can connect the printer and smart device over a wireless network, check the ink levels and printer status, and check for solutions if an error occurs. You can also copy easily by registering a copy favorite.



Install Epson Smart Panel from the following URL or QR code.

<https://support.epson.net/smpdl/>



Start Epson Smart Panel, and then select the print menu on the home screen.

## Printing Documents Using AirPrint

AirPrint enables instant wireless printing from iPhone, iPad, iPod touch, and Mac without the need to install drivers or download software.



**Note:**

*If you disabled paper configuration messages on your printer control panel, you cannot use AirPrint. See the link below to enable the messages, if necessary.*

1. Set up your printer for wireless printing. See the link below.  
<https://epson.sn>
2. Connect your Apple device to the same wireless network that your printer is using.
3. Print from your device to your printer.

**Note:**

*For details, see the AirPrint page on the Apple website.*

### Related Information

➔ [“Cannot Print Even Though a Connection has been Established \(iOS\)” on page 295](#)

## Printing Using Epson Print Enabler

You can wirelessly print your documents, emails, photos, and web pages right from your Android phone or tablet (Android v4.4 or later). With a few taps, your Android device will discover an Epson printer that is connected to the same wireless network.

Search for and install Epson Print Enabler from Google Play.

Go to **Settings** on your Android device, select **Printing**, and then enable Epson Print Enabler. From an Android application such as Chrome, tap the menu icon and print whatever is on the screen.

**Note:**

*If you do not see your printer, tap **All Printers** and select your printer.*

## Printing Using Mopria Print Service

Mopria Print Service enables instant wireless printing from Android smart phones or tablets.

Install Mopria Print Service from Google Play.



For more details, access the Mopria Web site at <https://mopria.org>.

---

# Printing on Envelopes

## Printing on Envelopes from a Computer (Windows)

1. Load envelopes in the printer.  
“Loading Paper” on page 142
2. Open the file you want to print.
3. Access the printer driver window.
4. Select the envelope size from **Document Size** on the **Main** tab, and then select **Envelope** from **Paper Type**.
5. Set the other items on the **Main** and **More Options** tabs as necessary, and then click **OK**.
6. Click **Print**.

## Printing on Envelopes from a Computer (Mac OS)

1. Load envelopes in the printer.  
“Loading Paper” on page 142

2. Open the file you want to print.
3. Select **Print** from the **File** menu or another command to access the print dialog.
4. Select the size as the **Paper Size** setting.
5. Select **Print Settings** from the pop-up menu.
6. Select **Envelope** as the **Media Type** setting.
7. Set the other items as necessary.
8. Click **Print**.

---

## Printing Photos

### Printing JPEG Files from a Memory Device

You can print JPEG files from a memory device connected to the printer.

1. Connect the memory device to the printer's external interface USB port.  
[“Inserting an External USB Device” on page 149](#)
2. Select **Memory Device** on the home screen.
3. Select **JPEG**.
4. Select the file, and then proceed to the next screen.
5. Tap .

### Basic Menu Options for JPEG Settings

 (Options):

Make settings for ordering, selecting, and deselecting image data.

Paper Setting:

Specify the paper source settings which you want to print on.

### Advanced Menu Options for JPEG Settings

Layout:

Select the way of layout the JPEG files. **1-up** is for printing a file per a page. **20-up** is for printing 20 files per a page. **Index** is for making index printing with information.

Fit Frame:

Select **On** to crop the image to fit into the selected print layout automatically. If the aspect ratio of the image data and the paper size is different, the image is automatically enlarged or reduced so that the short sides match the short sides of the paper. The long side of the image is cropped if it extends beyond the long side of the paper. This feature may not work for panorama photos.

Quality:

Select **Best** for higher quality printing, but the printing speed may be slower.

Date:

Select the format of the date the photo was taken or saved. The date is not printed for some layouts.

## Printing TIFF Files from a Memory Device

You can print TIFF files from a memory device connected to the printer.

1. Connect the memory device to the printer's external interface USB port.  
[“Inserting an External USB Device” on page 149](#)
2. Select **Memory Device** on the home screen.
3. Select **TIFF**.
4. Select the file, and then proceed to the next screen.
5. Tap .

## Basic Menu Options for TIFF Settings

 (Display order) :

Changes the order of the files.

Paper Setting:

Specify the paper source settings which you want to print on.

## Advanced Menu Options for TIFF Settings

Layout:

Select how to layout the Multi-TIFF file. **1-up** is for printing one page per sheet. **20-up** is for printing 20 pages on one sheet. **Index** is for making index printing with information.

Fit Frame:

Select **On** to crop the image to fit into the selected print layout automatically. If the aspect ratio of the image data and the paper size is different, the image is automatically enlarged or reduced so that the short sides match the short sides of the paper. The long side of the image is cropped if it extends beyond the long side of the paper. This feature may not work for panorama photos.

Quality:

Select **Best** for higher quality printing, but the printing speed may be slower.

Print Order:

Select the order for printing multi-page files.

Date:

Select the format of the date the photo was taken or saved. The date is not printed for some layouts.

---

## Printing Web Pages

### Printing Web Pages from Smart Devices

Install Epson Smart Panel from the following URL or QR code.

<https://support.epson.net/smpdl/>



Open the web page you want to print in your web browser app. Tap **Share** from the menu of the web browser application, select **Smart Panel**, and then start printing.

---

## Printing Using a Cloud Service

By using Epson Connect service available on the Internet, you can print from your smartphone, tablet PC, or laptop, anytime and practically anywhere. To use this service, you need to register the user and the printer in Epson Connect.

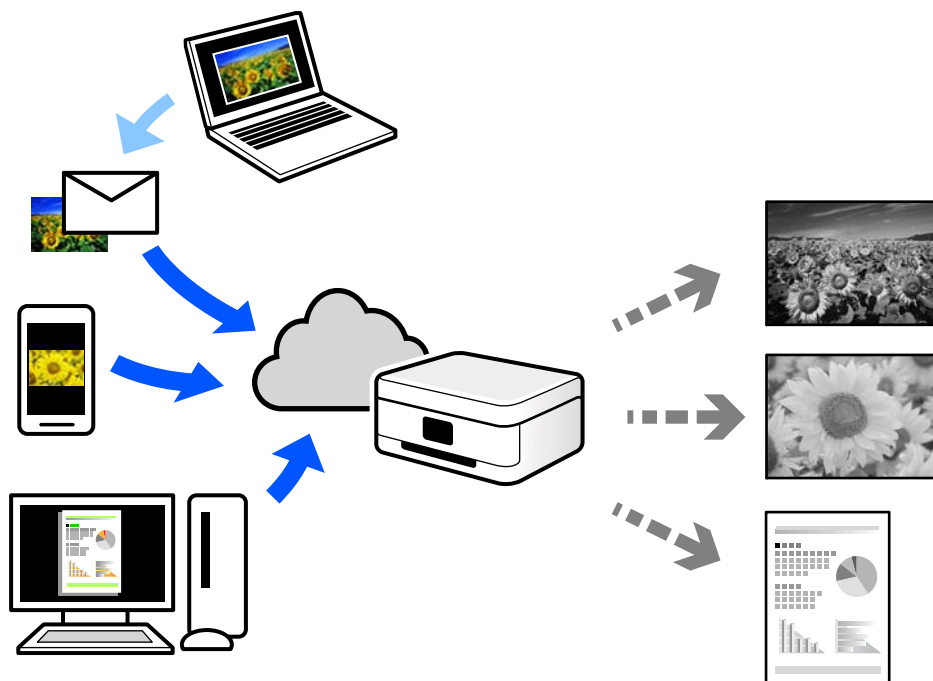

The features available on the Internet are as follows.

Email Print

When you send an email with attachments such as documents or images to an email address assigned to the printer, you can print that email and the attachments from remote locations such as your home or office printer.

Remote Print Driver

This is a shared driver supported by Remote Print Driver. When printing using a printer in a remote location, you can print by changing the printer on the usual applications window.

See the Epson Connect web portal for details on how to setup or print.

<https://www.epsonconnect.com/>

<http://www.epsonconnect.eu> (Europe only)

---

## Interrupting and Printing

You can interrupt the current print job and execute another job that has been received.

**Note:**

However, you cannot interrupt a new job from the computer.

1. Press the  button on the printer's control panel while printing.  
Printing is interrupted and the printer enters interruption mode.

2. Select **Job/Status** on the home screen.
3. Select the **Job** tab, and then select the job you want to interrupt from the **Active** list.
4. Select **Details** to display the Job Details.
5. Select **Interrupt** on the screen displayed.  
The print job you selected is executed.

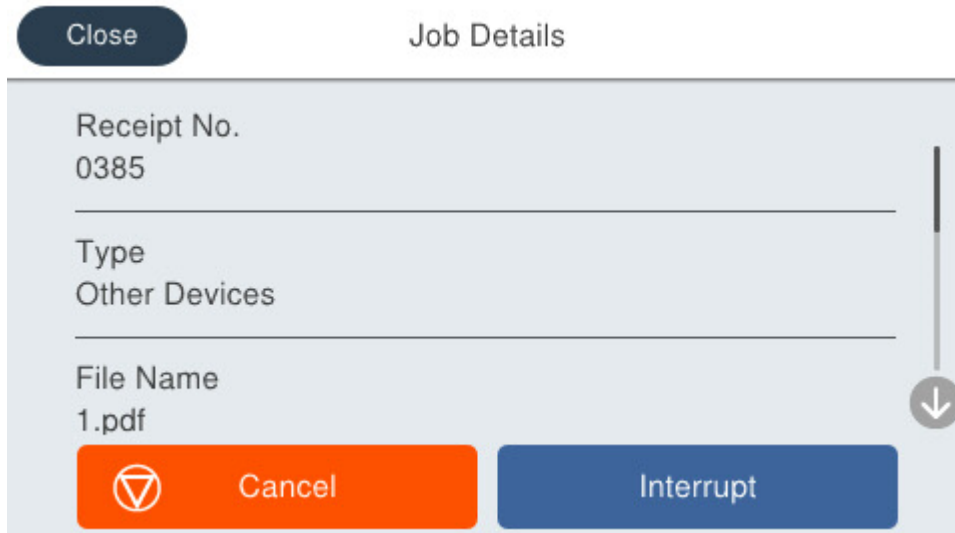

To restart a paused job, press the  button again to exit interruption mode. Also, when no operations are performed for a specific length of time after interrupting the print job, the printer exits interruption mode.



---

# Copying

Available Copying Methods. . . . .	198
Interrupting and Copying. . . . .	203
Basic Menu Options for Copying. . . . .	203
Advanced Menu Options for Copying. . . . .	205

## Available Copying Methods

Place the originals on the scanner glass or the ADF, and then select the **Copy** menu on the home screen.

### Copying Originals

You can copy fixed size or custom size originals in monochrome.

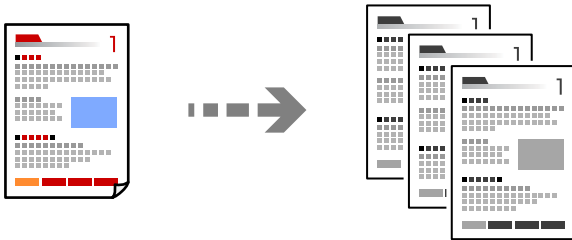

1. Load paper in the printer.  
[“Loading Paper” on page 142](#)
2. Place the originals.  
[“Placing Originals” on page 145](#)
3. Select **Copy** on the home screen.
4. Tap .

### Copying on 2-Sides

Copy multiple originals on both sides of the paper.



1. Place all originals face up in the ADF.



**Important:**

*If you want to copy originals that are not supported by the ADF, use the scanner glass.*

[“Originals that are not Supported by the ADF” on page 146](#)

**Note:**

*You can also place the originals on the scanner glass.*

[“Placing Originals” on page 145](#)

2. Select **Copy** on the home screen.
3. Select the **Basic Settings** tab, select **2-Sided**, and then select the 2-sided menu option you want to perform.
4. Specify other settings such as the original orientation and the binding position.
5. Tap .

## Copying by Enlarging or Reducing

You can copy originals at a specified magnification.

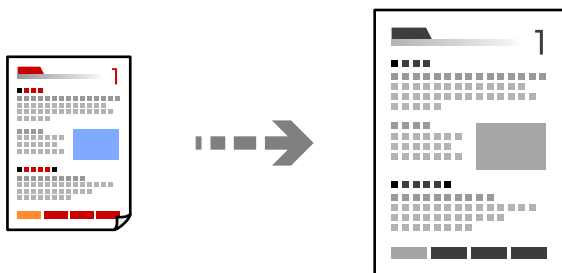

1. Place the originals.  
[“Placing Originals” on page 145](#)
2. Select **Copy** on the home screen.
3. Select the **Basic Settings** tab, and then select **Reduce/Enlarge**.
4. Specify the amount of enlargement or reduction.
5. Tap .

## Copying Multiple Originals onto One Sheet

You can copy the multiple originals onto a single sheet.

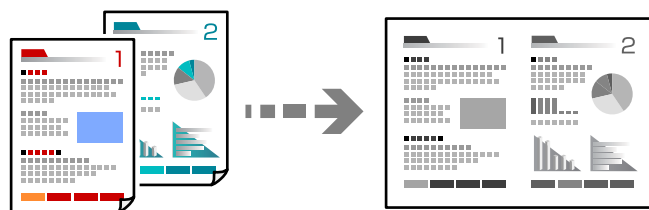

1. Place all originals face up in the ADF.  
Place them in the direction shown in the illustration.

Readable Direction

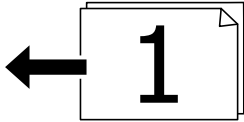
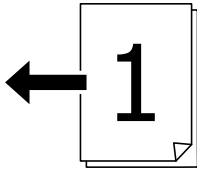

Left Direction

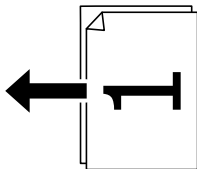
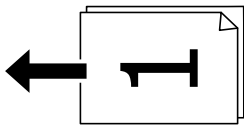

**!** **Important:**

*If you want to copy originals that are not supported by the ADF, use the scanner glass.*

*[“Originals that are not Supported by the ADF” on page 146](#)*

**Note:**

*You can also place the originals on the scanner glass.*

*[“Placing Originals” on page 145](#)*

2. Select **Copy** on the home screen.
3. Select the **Advanced** tab, select **Multi-Page**, and then select **2-up** or **4-up**.
4. Specify the layout order and the original orientation.
5. Tap .

## Copying in Page Order

When making multiple copies of a multi-page document, you can discharge one copy at a time in page order.

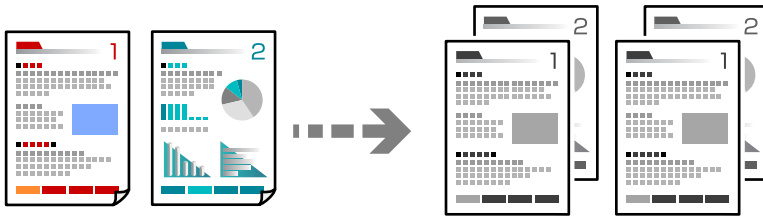

1. Place the originals.  
[“Placing Originals” on page 145](#)
2. Select **Copy** on the home screen.
3. Select the **Advanced** tab, and then select **Finishing > Collate (Page Order)**.
4. Tap .

## Copying Originals Using Good Quality

You can copy originals without shadows or punched holes or adjust the image quality.

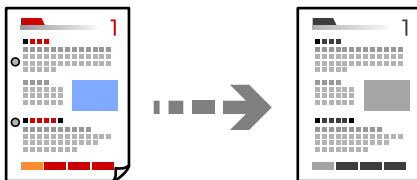

1. Place the originals.  
[“Placing Originals” on page 145](#)
2. Select **Copy** on the home screen.
3. Select the **Advanced** tab, and then enable **Remove Shadow** or **Remove Punch Holes** or adjust the image quality in **Image Quality**.
4. Tap .

## Copying ID card

Scans both sides of an ID card and copies onto one side of a paper.

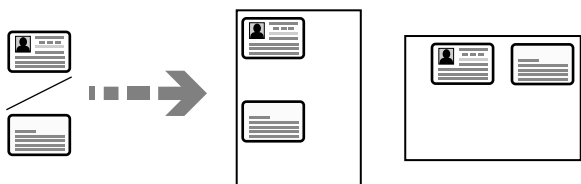

1. Place the originals.  
    [“Placing Originals” on page 145](#)
2. Select **Copy** on the home screen.
3. Select the **Basic Settings** tab, select **ID Card Copy**, and then enable the setting.
4. Specify the **Orientation (Original)**.
5. Tap .

## Copying Envelopes

You can copy envelopes.

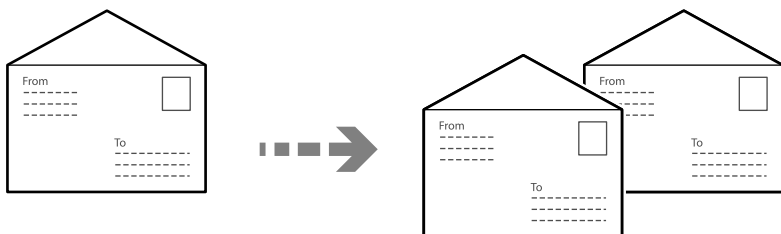

Make sure the envelopes are loaded in the correct orientation.

Loading paper

See the related information.

[“Loading Paper” on page 142](#)

Placing originals

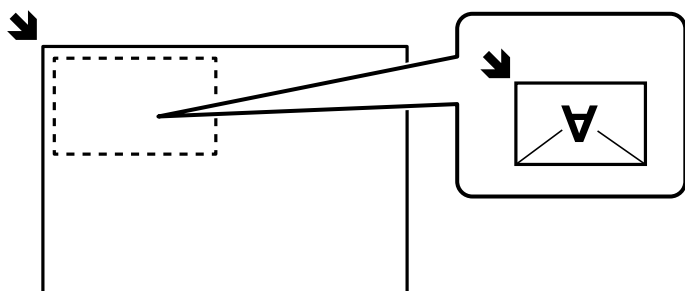

Place the original on the scanner glass. When placing an envelope, place it in the orientation as shown in the illustration.



---

## Interrupting and Copying

You can interrupt the current print job and perform copying operations.

1. Press the  button on the printer's control panel while printing.  
Printing is interrupted and the printer enters interruption mode.
2. Place the originals.  
[“Placing Originals” on page 145](#)
3. Select **Copy** on the home screen.
4. Change the settings in **Basic Settings** and **Advanced** if necessary.
5. Tap .

To restart a paused job, press the  button again to exit interruption mode. Also, when no operations are performed for a specific length of time after interrupting the print job, the printer exits interruption mode.

---

## Basic Menu Options for Copying

**Note:**

*The items may not be available depending on other settings you made.*

**Density:**

Increase the level of density when the copying results are faint. Decrease the level of density when ink smears.

**Paper Setting:**

Select the paper source that you want to use. When **Auto** is selected, paper is fed automatically using the **Paper Setting** settings made when you loaded the paper.

**Reduce/Enlarge:**

Configures the magnification ratio of the enlargement or reduction. Tap the value and specify the magnification used to enlarge or reduce the original within a range of 25 to 400%.

Auto

Enlarge or reduce the original size automatically to the magnification of the paper size. For example, if you set the original size to A6 and set the paper size to A4, the magnification automatically adjusts to 200.

When there are white margins around the original, the white margins from the corner mark (↘) of the scanner glass are detected as the scan area, but the margins at the opposite side may be cropped.

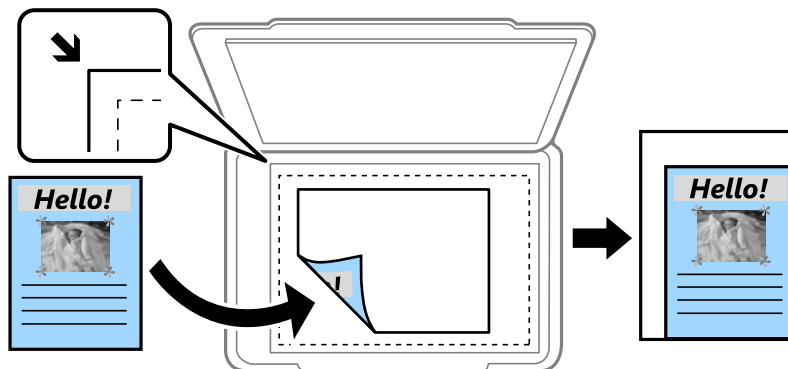

Reduce to Fit Paper

Copies the scanned image at a smaller size than the Reduce/Enlarge value to fit within the paper size. If the Reduce/Enlarge value is larger than the paper size, data may be printed beyond the edges of the paper.

Actual Size

Copies at 100 % magnification.

A4→A5 and others

Automatically enlarges or reduces the original to fit to a specific paper size.

Original Type:

Select the type of your original. Copies in optimal quality to match the type of original.

2-Sided:

Select 2-sided layout.

1→1-Sided

Copies one side of an original onto a single side of paper.

2→2-Sided

Copies both sides of a double-sided original onto both sides of a single sheet of paper. Select the orientation of your original and the binding position of the original and the paper.

1→2-Sided

Copies two single-sided originals onto both sides of a single sheet of paper. Select the orientation of your original and the binding position of the paper.

2→1-Sided

Copies both sides of a double-sided original onto one side of two sheets of paper. Select the orientation of your original and the binding position of the original.



**ID Card Copy:**

Scans both sides of an ID card and copies onto one side of a paper.

---

## Advanced Menu Options for Copying

**Note:**

*The items may not be available depending on other settings you made.*

**Multi-Page:**

Select the copy layout.

- Single Page

Copies a single-sided original onto a single sheet.

- 2-up

Copies two single-sided originals onto a single sheet in 2-up layout. Select the layout order and the orientation of your original.

- 4-up

Copies four single-sided originals onto a single sheet in 4-up layout. Select the layout order and the orientation of your original.

**Original Size:**

Select the size of your original. When copying non-standard size originals, select the size closest to your original.

**Finishing:**

Select how to eject the paper for multiple copies of multiple originals.

- Group (Same Pages)

Copies the originals by page as a group.

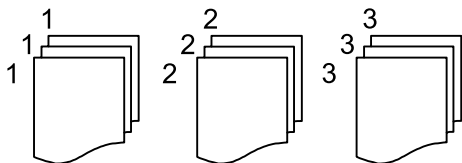

- Collate (Page Order)

Copies the originals collated in order and sorted into sets.

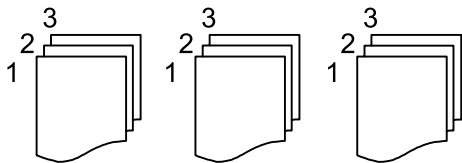

**Orientation (Original)**

Select the orientation of your original.

**Image Quality:**

Adjust image settings.

Contrast

Adjust the difference between the bright and dark parts.

Sharpness

Adjust the outline of the image.

Remove Background

Adjust the density of the background color. Tap + to make it bright (white) and tap - to make it dark (black).

**Binding Margin:**

Select such as the binding position, margin, and orientation of your original.

**Reduce to Fit Paper:**

Copies the scanned image at a smaller size than the Reduce/Enlarge value to fit within the paper size. If the Reduce/Enlarge value is larger than the paper size, data may be printed beyond the edges of the paper.

**Remove Shadow:**

Removes shadows that appear around copies when copying thick paper or that appear in the center of copies when copying a booklet.

**Remove Punch Holes:**

Removes the binding holes when copying.

---

# Scanning

Available Scanning Methods. . . . .	208
Scanning Originals to a Network Folder. . . . .	208
Scanning Originals to an Email. . . . .	210
Scanning Originals to a Computer. . . . .	211
Scanning Originals to a Memory Device. . . . .	212
Scanning Originals to the Cloud. . . . .	212
Menu Options for Scanning. . . . .	213
Scanning Using WSD. . . . .	214
Scanning Originals to a Smart Device. . . . .	216

## Available Scanning Methods

You can use any of the following methods to scan using this printer.

### Scanning to a Network Folder

You can save the scanned image to a pre-configured folder on a network.

[“Scanning Originals to a Network Folder” on page 208](#)

### Scanning to an Email

You can send scanned image files by email directly from the printer through a pre-configured email server.

[“Scanning Originals to an Email” on page 210](#)

### Scanning to a Computer

You can save the scanned image to a computer connected to the printer.

[“Scanning Originals to a Computer” on page 211](#)

### Scanning to a Memory Device

You can save scanned images directly to a memory device inserted into the printer.

[“Scanning Originals to a Memory Device” on page 212](#)

### Sending to a Cloud Service

You can send scanned images from the printer's control panel to cloud services that have been registered in advance.

[“Scanning Originals to the Cloud” on page 212](#)

### Scanning Using WSD

You can save the scanned image to a computer connected to the printer, using WSD feature.

[“Scanning Using WSD” on page 214](#)

### Scanning Directly from Smart Devices

You can save scanned images directly to a smart device such as a smart phone or tablet by using the Epson Smart Panel application on the smart device.

[“Scanning Originals to a Smart Device” on page 216](#)

---

## Scanning Originals to a Network Folder

Check the following before scanning.

- Make sure that a network folder is prepared. See the following when creating a shared folder on a network.  
[“Creating the Shared Folder” on page 69](#)
- Register a network folder path in your contacts in advance to easily specify the folder.  
[“Contacts Registration” on page 87](#)

**Note:**

Make sure the printer's **Date/Time** and **Time Difference** settings are correct. Access the menus from **Settings > General Settings > Basic Settings > Date/Time Settings**.

1. Place the originals.  
“Placing Originals” on page 145
2. Select **Scan > Network Folder/FTP** on the control panel.
3. Specify the destination.  
“Destination Menu Options for Scanning to a Network Folder” on page 209

**Note:**

You can print the history of the folder in which documents are saved, by selecting .

4. Select **Scan Settings**, and then check settings such as the save format, and change them if necessary.  
“Menu Options for Scanning” on page 213

**Note:**

Select  to save your settings as a preset.

5. Tap .

## Destination Menu Options for Scanning to a Network Folder

Keyboard:

Open the **Edit Location** screen. Enter the folder path and set each item on the screen.

Edit Location:

Enter the folder path and set each item on the screen.

Communication Mode:

Select the communication mode for the folder.

Location (Required):

Enter a folder path in which to save the scanned image.

Selecting the **Browse** searches a folder on computers connected to the network. You can use the **Browse** only when **Communication Mode** is set to SMB.

User Name:

Enter a user name to log on to the specified folder.

Password:

Enter a password corresponding to the user name.

Connection Mode:

Select the connection mode for the folder.

Port Number:

Enter a port number for the folder.

Proxy Server Settings:

Select whether or not to use a proxy server.

**Contacts:**

Select a destination from the contacts list.

You can search for a contact from the contacts list. Enter the search keyword into the box at the top of the screen.

---

## Scanning Originals to an Email

You need to setup the following before scanning.

- Configure the email server.

[“Configuring a Mail Server” on page 65](#)

- Register an email address in your contacts in advance so that you can easily specify the address by selecting it from your contacts.

- Make sure the printer's **Date/Time** and **Time Difference** settings are correct. Access the menus from **Settings > General Settings > Basic Settings > Date/Time Settings**.

1. Place the originals.

[“Placing Originals” on page 145](#)

2. Select **Scan > Email** on the control panel.

3. Specify the recipient.

[“Recipient Menu Options for Scanning to an Email” on page 210](#)

**Note:**

- The number of recipients you selected is displayed on the right of the screen. You can send emails to up to 10 addresses and groups.*

*If groups is included in recipients, you can select up to 200 individual addresses in total, taking addresses in the groups into account.*

- Select the address box at the top of the screen to display the list of selected addresses.*

- Select  to display or print the sending history, or change the email server settings.*

4. Select **Scan Settings**, and then check settings such as the save format, and change them if necessary.

[“Menu Options for Scanning” on page 213](#)

**Note:**

Select  to save your settings as a preset.

5. Tap .

## Recipient Menu Options for Scanning to an Email

**Keyboard:**

Enter the email address manually.

**Contacts:**

Select a destination from the contacts list.

You can search for a contact from the contacts list. Enter the search keyword into the box at the top of the screen.

**History:**

Select the address from the history list.

---

## Scanning Originals to a Computer

You can save the scanned image to a computer connected over a network.

The method of saving images is registered as a *job* in Document Capture Pro installed on your computer. Preset jobs are available that allow you to save scanned images to a computer. You can also create and register new jobs using Document Capture Pro on your computer.

**Note:**

*You need to setup the following before scanning.*

- Install the following applications on your computer.*
  - Document Capture Pro
  - Epson Scan 2 (application required to use the scanner feature)

*See the following to check for installed applications.*

*Windows 11: Click the start button, and then check the **All apps** > **Epson Software** folder > **Document Capture Pro**, and the **EPSON** folder > **Epson Scan 2**.*

*Windows 10: Click the start button, and then check the **Epson Software** folder > **Document Capture Pro**, and the **EPSON** folder > **Epson Scan 2**.*

*Windows 8.1/Windows 8: Enter the application name in the search charm, and then check the displayed icon.*

*Windows 7: Click the start button, and then select **All Programs**. Next, check the **Epson Software** folder > **Document Capture Pro**, and the **EPSON** folder > **Epson Scan 2**.*

*Mac OS: Select **Go** > **Applications** > **Epson Software**.*

- Connect the printer and the computer over a network.*
- If you are using Document Capture Pro Server on Windows Server, set the **Operation Mode** to **Server Mode** on Web Config or the printer's control panel.*

1. Place the originals.  
[“Placing Originals” on page 145](#)
2. Select **Scan** > **Computer** on the control panel.
3. Select **Select Computer.**, and then select the computer on which Document Capture Pro is installed.

**Note:**

- The printer's control panel displays up to 110 computers on which Document Capture Pro is installed.*
- If **Server Mode** is set as the operation mode, you do not need to perform this step.*

4. Select the job.
5. Select the area in which the job content is displayed, and then check the job details.

6. Tap .

Document Capture Pro automatically starts on your computer, and scanning starts.

**Note:**

- ❑ See the Document Capture Pro help for details on using the features, such as creating and registering new jobs.
- ❑ You can not only start scanning from the printer but also from your computer by using Document Capture Pro. See the Document Capture Pro help for details.

**Related Information**

- ➔ [“Setting Server Mode” on page 114](#)

---

## Scanning Originals to a Memory Device

1. Place the originals.  
[“Placing Originals” on page 145](#)
2. Insert a memory device into the printer.
3. Select **Scan > Memory Device** on the control panel.
4. Make the scan settings.  
[“Menu Options for Scanning” on page 213](#)

**Note:**

Select  to save your settings as a preset.

5. Tap .

---

## Scanning Originals to the Cloud

Before using this feature, make settings using Epson Connect. See the following Epson Connect portal website for details.

<https://www.epsonconnect.com/>

<http://www.epsonconnect.eu> (Europe only)

1. Place the originals.  
[“Placing Originals” on page 145](#)
2. Select **Scan > Cloud** on the control panel.
3. Select  on the top of the screen, and then select a destination.
4. Make the scan settings.  
[“Menu Options for Scanning” on page 213](#)



**Note:**

Select  to save your settings as a preset.

5. Tap .

---

## Menu Options for Scanning

Some items may not be available depending on the scanning method you have selected or other settings you have made.

### Color Mode:

Select whether to scan in color or in monochrome.

### File Format:

Select the format in which to save the scanned image.

When you want to save as PDF, PDF/A, or TIFF, select whether to save all originals as one file (multi-page) or save each original separately (single page).

Compression Ratio:

Select how much to compress the scanned image.

PDF Settings:

When you have selected PDF as the save format setting, use these settings to protect PDF files.

To create a PDF file that requires a password when opening, set Document Open Password. To create a PDF file that requires a password when printing or editing, set Permissions Password.

### Resolution:

Select the scanning resolution.

### 2-Sided:

Scan both sides of the original.

Orientation (Original):

Select the orientation of the original.

Binding(Original):

Select the binding direction of the original.

### Scan Area:

Select the scan area. To crop the white space around the text or image when scanning, select **Auto Cropping**. To scan at the maximum area of the scanner glass, select **Max Area**.

Orientation (Original):

Select the orientation of the original.

### Original Type

Select the type of your original.

**Orientation (Original):**

Select the orientation of the original.

**Density:**

Select the contrast of the scanned image.

**Remove Shadow:**

Remove the shadows of the original that appear in the scanned image.

**Frame:**

Remove the shadows at the edge of the original.

**Center:**

Remove the shadows of the binding margin of the booklet.

**Remove Punch Holes:**

Remove the punch holes that appear in the scanned image. You can specify the area to erase the punch holes by entering a value in the box on the right.

**Erasing Position:**

Select the position to remove the punch holes.

**Orientation (Original):**

Select the orientation of the original.

**Subject:**

Enter a subject for the email in alphanumeric characters and symbols.

**Attached File Max Size:**

Select the maximum file size that can be attached to the email.

**File Name:**

**Filename Prefix:**

Enter a prefix for the name of the images in alphanumeric characters and symbols.

**Add Date:**

Add the date to the file name.

**Add Time:**

Add the time to the file name.

---

## Scanning Using WSD

**Note:**

- This feature is only available for computers running Windows Vista or later.*
- If you are using Windows 7/Windows Vista, you need to setup your computer in advance using this feature.*  
*[“Setting Up a WSD Port” on page 215](#)*

1. Place the originals.

*[“Placing Originals” on page 145](#)*

2. Select **Scan > WSD** on the control panel.
3. Select a computer.
4. Tap .

## Setting Up a WSD Port

This section explains how to set up a WSD port for Windows 7/Windows Vista.

**Note:**

*For Windows 8 or later, the WSD port is set up automatically.*

The following is necessary to set up a WSD port.

- The printer and the computer are connected to the network.
- The printer driver is installed on the computer.

1. Turn the printer on.
2. Click start, and then click **Network** on the computer.
3. Right-click the printer, and then click **Install**.  
Click **Continue** when the **User Account Control** screen is displayed.  
Click **Uninstall** and start again if the **Uninstall** screen is displayed.

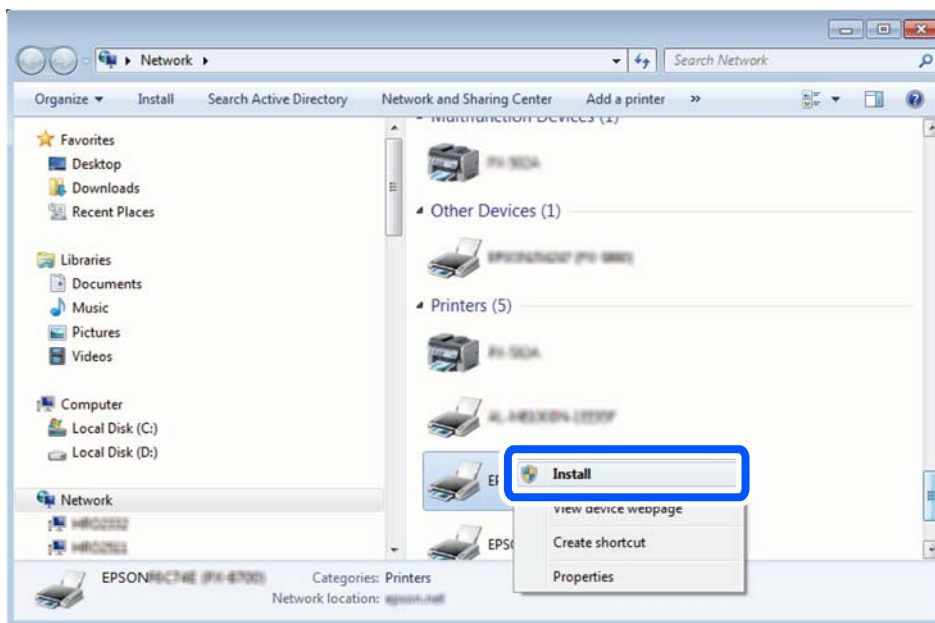

**Note:**

*The printer name you set on the network and model name (EPSON XXXXXX (XX-XXXX)) are displayed on the network screen. You can check the printer's name set on the network from the printer's control panel or by printing a network status sheet.*

4. Click **Your device is ready to use**.

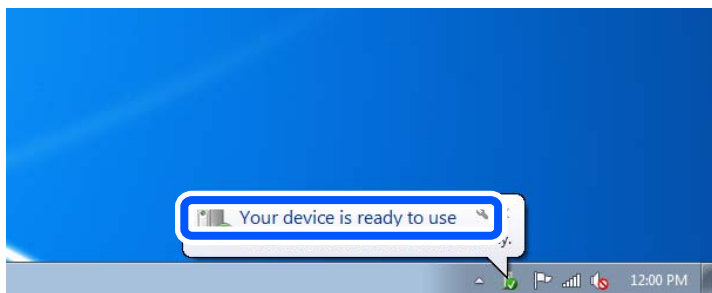

5. Check the message, and then click **Close**.

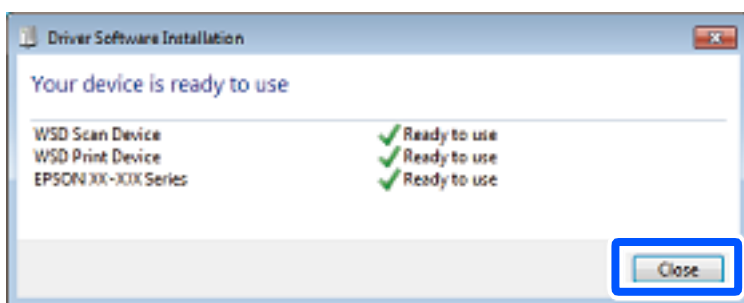

6. Open the **Devices and Printers** screen.
  - Windows 7  
Click start > **Control Panel** > **Hardware and Sound** (or **Hardware**) > **Devices and Printers**.
  - Windows Vista  
Click start > **Control Panel** > **Hardware and Sound** > **Printers**.
7. Check that an icon with the printer's name on the network is displayed.  
Select the printer name when using with WSD.

---

## Scanning Originals to a Smart Device

**Note:**

Before scanning, install *Epson Smart Panel* on your smart device.

1. Place the originals.  
[“Placing Originals” on page 145](#)
2. Start Epson Smart Panel on your smart device.
3. Select scan menu on the home screen.
4. Follow the on-screen instructions to scan and save the images.

---

# Faxing

Before Using Fax Features. . . . .	218
Overview of this Printer's Fax Features. . . . .	218
Sending Faxes Using the Printer. . . . .	225
Receiving Faxes on the Printer. . . . .	233
Menu Options for Faxing. . . . .	239
Menu Options for Fax Box. . . . .	243
Checking the Status or Logs for Fax Jobs. . . . .	250
Sending a Fax from a Computer. . . . .	252
Receiving Faxes on a Computer. . . . .	257

## Before Using Fax Features

When you want to check the status of the fax settings, print a **Fax Settings List** by selecting **Fax** >  (More) > **Fax Report** > **Fax Settings List**. If your organization has a printer administrator, contact your administrator to check the status or conditions of the connection and settings.

### Check the following before you start using the fax features.

- The printer and the phone line, and (if it is being used) the phone machine are connected correctly.  
[“Connecting the Printer to a Phone Line” on page 116](#)
- Fax basic settings (Fax Setting Wizard) is complete.  
[“Contacts Registration” on page 87](#)  
[“Making the Printer Ready to Send and Receive Faxes” on page 119](#)
- Other necessary Fax Settings are complete.  
[“Configuring a Mail Server” on page 65](#)  
[“Setting a Shared Network Folder” on page 69](#)  
[“Settings to use Your Cloud Service as Forwarding Fax Destinations” on page 97](#)  
[“Making Settings for the Printer's Fax Features According to Use” on page 121](#)

### See also the following:

- Solving Problems for Faxing:  
[“Cannot Send or Receive Faxes” on page 296](#)  
[“The Quality of the Sent Fax is Poor” on page 320](#)  
[“Received Fax Quality is Poor” on page 322](#)  
[“Cannot Operate the Printer as Expected” on page 335](#)
- Menu Options for Setting up Fax Features:  
[“Fax Settings” on page 369](#)

---

## Overview of this Printer's Fax Features

### Feature: Sending Faxes

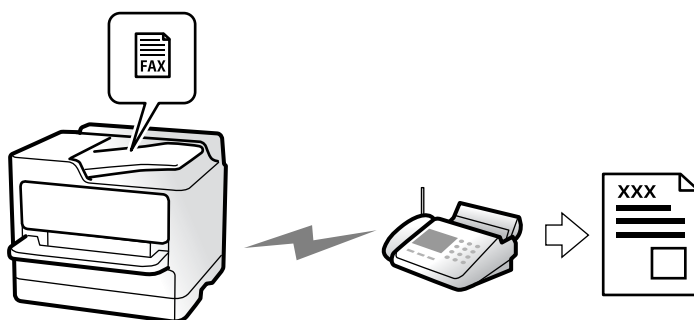

## Sending Methods

### Sending automatically

When you scan an original by tapping **Send**, the printer dials the recipients and sends the fax.

[“Sending Faxes Using the Printer” on page 225](#)

### Sending manually

When you perform a manual check on the line connection by dialing the recipient, tap **Send** to start sending a fax directly.

[“Sending Faxes Manually After Confirming the Recipient's Status” on page 227](#)

[“Sending Faxes Dialing from the External Phone Device” on page 228](#)

## Recipient Designation when Sending a Fax

You can enter recipients using **Keypad**, **Contacts**, and **Recent**.

[“Recipient” on page 239](#)

[“Contacts Registration” on page 87](#)

## Scan Settings when Sending a Fax

You can select items such as **Resolution** or **Original Size (Glass)** when sending faxes.

[“Scan Settings:” on page 239](#)

## Using Fax Send Settings when Sending a Fax

You can use **Fax Send Settings** such as **Direct Send** (to send a large document stably) or **Backup** when normal sending fails. If you make settings to back up sent faxes when sending a fax but the backup fails, the printer can send an email notification automatically when the backup is performed.

[“Fax Send Settings:” on page 240](#)

[“Backup Error Report:” on page 383](#)

[“Configuring a Mail Server” on page 65](#)

## Feature: Receiving Faxes

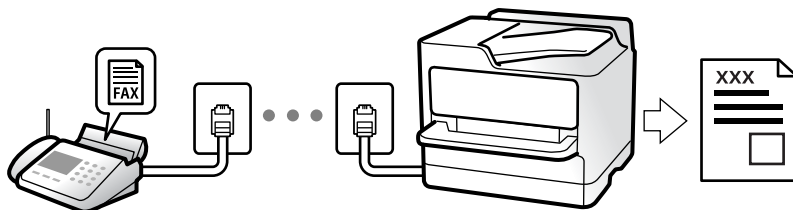

## Setting Receive Mode

Manual

Mainly for phoning, but also for faxing

[“Usage of Manual Mode” on page 234](#)

Auto

- Only for faxing (external phone device is not required)

- Mainly for faxing, and sometimes phoning

[“Usage of Auto Mode” on page 234](#)

## Receiving Faxes by Operating a Connected Phone

You can receive faxes by only operating an external phone device.

[“Remote Receive:” on page 371](#)

[“Making Settings When You Connect a Phone Device” on page 122](#)

## Destinations of Received Faxes

### **Output without conditions:**

Received faxes are printed unconditionally by default. You can set up destinations for received faxes to the inbox, a computer, an external memory, emails, folders, or other faxes.

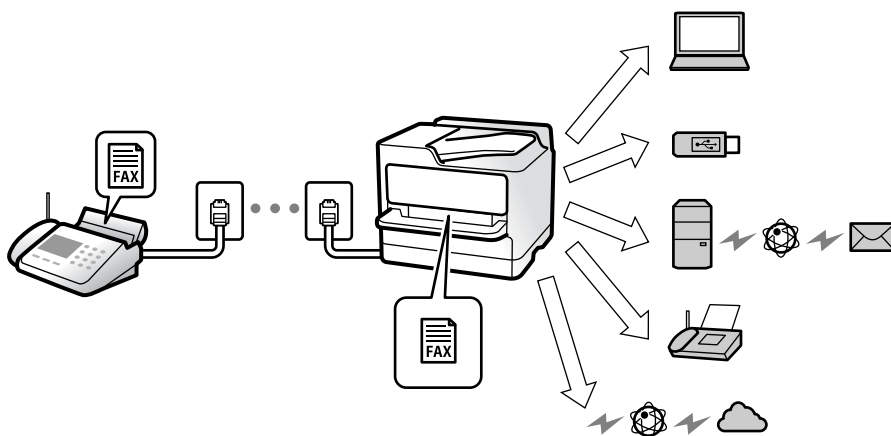

[“Unconditional Save/Forward:” on page 374](#)

[“Making Saving Settings to Receive Faxes” on page 123](#)

[“Forwarding Settings to Receive Faxes” on page 125](#)

If you save in the inbox, you can check the contents on the screen.



[“Inbox settings:” on page 380](#)

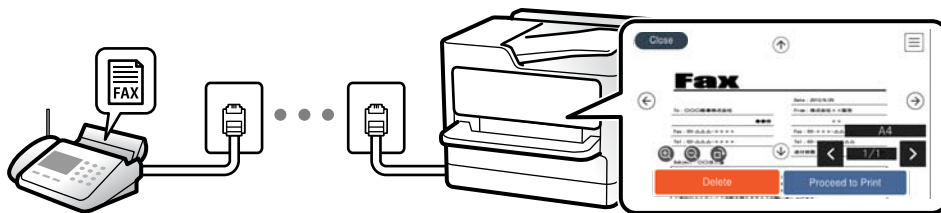

[“Viewing Received Faxes on the Printer's LCD Screen” on page 238](#)

### **Output when conditions match:**

You can set up destinations for received faxes to the inbox or a confidential box, an external memory, an email, a folder, or another fax when specific conditions are met. If you save in the inbox or a confidential box, you can check the contents on the screen.

[“Conditional Save/Forward:” on page 376](#)

[“Conditional Save/Forward list:” on page 242](#)

## **Feature: PC-FAX Send/Receive (Windows/Mac OS)**

### **PC-FAX Send**

You can send faxes from a computer.

[“Enabling Sending Faxes from a Computer” on page 132](#)

[“Application for Configuring Fax Operations and Sending Faxes \(FAX Utility\)” on page 354](#)

[“Application for Sending Faxes \(PC-FAX Driver\)” on page 355](#)

[“Sending a Fax from a Computer” on page 252](#)

### **PC-FAX Receive**

You can receive faxes on a computer.

[“Making Settings to Send and Receive Faxes on a Computer” on page 132](#)

[“Application for Configuring Fax Operations and Sending Faxes \(FAX Utility\)” on page 354](#)

[“Receiving Faxes on a Computer” on page 257](#)

## Features: Various Fax Reports

You can check the status of sent and received faxes in a report.

XX-XXXXXXXXX **EPSON**  
EXCEED YOUR VISION

**Fax Communication Log** PAGE: 001/001  
XXXX.XX.XX XX.XX.PM

Name : XXXX  
Fax : XXXX XX XXXX

Date	Time	Type	ID	Duration	Pages	Result
XX.XX	XX:XXPM	Send	XX XXXX XXXX	00:00	000/001	No Answer
XX.XX	XX:XXPM	Receive		00:37	001	OK
XX.XX	XX:XXAM	Send	XXX XXX XXXX			OK

[“Report Settings” on page 383](#)

[“Fax Send Settings:” on page 240](#)

[“Transmission Log:” on page 242](#)

[“Fax Report:” on page 242](#)

## Feature: Status or Logs for Fax Jobs

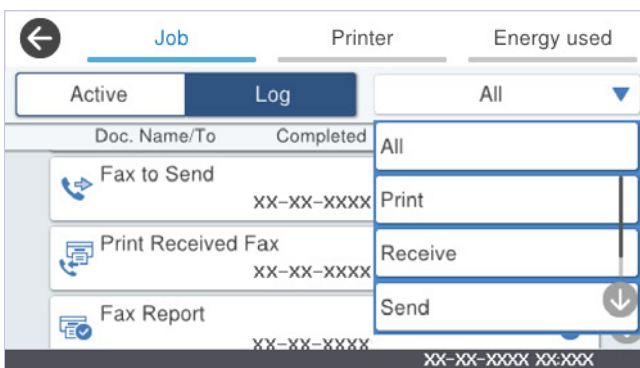

You can check the fax jobs in progress or check the job history.

[“Checking the Status or Logs for Fax Jobs” on page 250](#)

## Feature: Fax Box

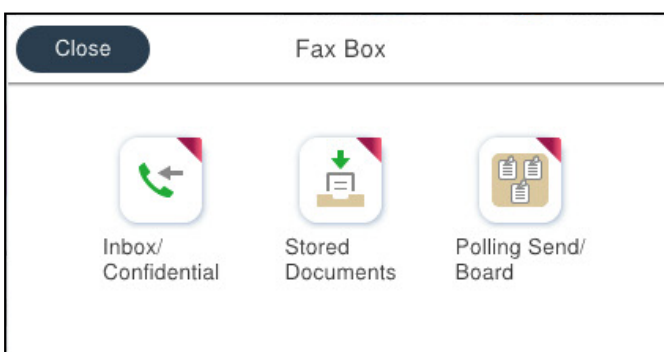

## Inbox and confidential boxes

You can store received faxes in the inbox or confidential boxes.

[“Inbox/Confidential” on page 243](#)

## Stored Documents Box

You can send faxes using documents saved in this box.

[“Stored Documents:” on page 245](#)

## Polling Send/Board Box

Documents stored in the Polling Send box or bulletin board boxes can be sent upon request from another fax machine.

[“Polling Send/Board” on page 246](#)

## Security for Fax Box feature

You can set a password for each box.

[“Feature: Security when Sending and Receiving Faxes” on page 223](#)

## Feature: Security when Sending and Receiving Faxes

**You can use many security features.**

You can use many security features such as **Direct Dialing Restrictions** to prevent sending to the wrong destination, or **Backup Data Auto Clear** to prevent information leakage.

[“Security Settings” on page 384](#)

[“Box Document Delete Settings:” on page 380](#)

[“Menu Options for Fax Box” on page 243](#)

**You can set a password for each fax box in the printer.**

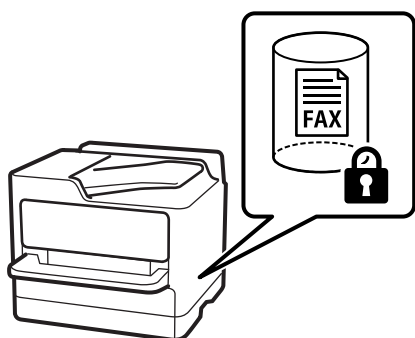

[“Inbox Password Settings:” on page 380](#)

[“Menu Options for Fax Box” on page 243](#)

## Features: Other Useful Features

### Blocking Junk Faxes

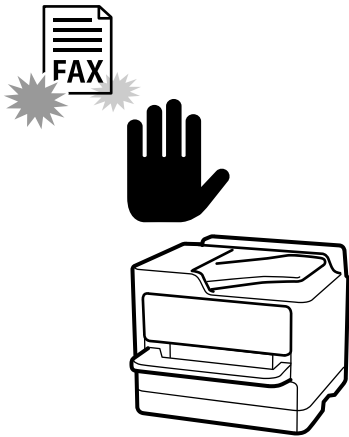

You can reject junk fax.

[“Making Settings for Blocking Junk Faxes” on page 131](#)

### Receiving Faxes After Dialing

After dialing to another fax machine, you can receive the document from the fax machine.

[“Receiving Faxes by Making a Phone Call” on page 235](#)

[“Polling Receive:” on page 242](#)

### Regarding Sending Faxes

You can display the settings that you use frequently to send faxes at the top of the **Fax Settings** tab.

[“Quick Operation Button” on page 370](#)

[“Quick Operation Button:” on page 239](#)

## Sending Faxes Using the Printer

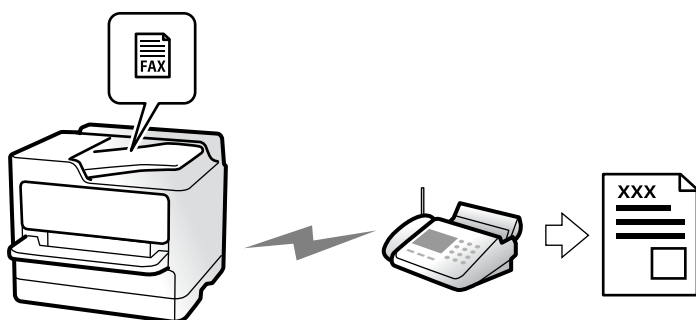

You can send faxes by entering fax numbers for recipients on the control panel.

**Note:**

- ❑ When sending a fax in monochrome, you can preview the scanned image on the LCD screen before sending.
- ❑ You can reserve up to 50 monochrome fax jobs even while the phone line is in use for a voice call, sending another fax, or receiving a fax. You can check or cancel reserved fax jobs from .

1. Place the originals.

[“Placing Originals” on page 145](#)

You can send up to 200 pages in one transmission; however depending on the remaining amount of memory, you may not be able to send faxes even with less than 200 pages.

2. Select **Fax** on the home screen.

3. Specify the recipient.

[“Selecting Recipients” on page 226](#)

4. Select the **Fax Settings** tab, and then make settings such as **Resolution** and **Direct Send**.

[“Fax Settings” on page 239](#)

5. Tap  (**Presets**) on the fax top screen to save the current settings and the recipients in Presets. This allows you to easily load the settings at any time.

Recipients may not be saved depending on how you specified the recipients, such as entering a fax number manually.

6. Tap  to send the fax.

**Note:**

- ❑ If the fax number is busy or there is some problem, the printer automatically redials after one minute.
- ❑ To cancel sending, tap .
- ❑ It takes longer to send a fax in color because the printer performs scanning and sending simultaneously. While the printer is sending a fax in color, you cannot use the other features.

**Related Information**

- ➔ [“Checking Fax Jobs in Progress” on page 251](#)

## Selecting Recipients

You can specify recipients on the **Recipient** tab to send the fax using the following methods.

### Entering Fax Number Manually

Select **Keypad**, enter a fax number on the screen displayed, and then tap **OK**.

- To add a pause (pause for three seconds during dialing), enter a hyphen(-).

- If you have set an external access code in **Line Type**, enter "#" (hash) instead of the actual external access code at the beginning of the fax number.

#### Note:

If you cannot manually enter a fax number, **Direct Dialing Restrictions in Security Settings** is set to **On**. Select fax recipients from the contacts list or the sent fax history.

### Selecting recipients from the contacts list

Select **Contacts** and select recipients you want to send. If the recipient you want to send to has not been registered in **Contacts** yet, tap  to register it.

### Selecting recipients from the sent fax history

Select **Recent**, and then select a recipient.

### Selecting recipients from the list on the Recipient tab

Select a recipient from the list registered in **Settings > Contacts Manager > Frequent**.

#### Note:

To delete recipients you selected or entered, display the list of recipients by tapping on the field of a fax number or the number of recipients on the LCD screen, select the recipient from the list, and then select **Remove**.

### Related Information

- ➔ [“Contacts Registration” on page 87](#)
- ➔ [“Destination Setting Items” on page 89](#)
- ➔ [“Recipient” on page 239](#)









## Various Ways of Sending Faxes

### Sending the Fax after Checking the Scanned Image



You can preview the scanned image on the LCD screen before sending the fax. (Monochrome faxes only)

1. Place the originals.  
    [“Placing Originals” on page 145](#)
2. Select **Fax** on the home screen.
3. Specify the recipient.  
    [“Selecting Recipients” on page 226](#)
4. Select the **Fax Settings** tab, and then make settings as necessary.  
    [“Fax Settings” on page 239](#)

5. Tap , check the scanned document image.
  -     : Moves the screen in the direction of the arrows.
  -   : Reduces or enlarges.
  -   : Moves to the previous or the next page.

**Note:**

- When **Direct Send** is enabled, you cannot preview.
- When the preview screen is left untouched for the time set in **Settings > General Settings > Fax Settings > Send Settings > Fax Preview Display Time**, the fax is sent automatically.

6. Select **Start Sending**. Otherwise, select **Cancel**

**Note:**

*The image quality of a sent fax may be different from what you previewed depending on the capability of the recipient machine.*

## **Sending Faxes Manually After Confirming the Recipient's Status**

You can send a fax while listening to sounds or voices through the printer's speaker while dialing, communicating, and transmitting.

1. Select **Fax** on the home screen.
2. Make necessary settings on the **Fax Settings** tab.  
    [“Fax Settings” on page 239](#)
3. On the **Recipient** tab, tap  and then specify the recipient.

**Note:**

*You can adjust the sound volume of the speaker.*

4. When you hear a fax tone, select **Send/Receive** at the upper right corner of the LCD screen, and then select **Send**.

**Note:**

*When receiving a fax from a fax information service, and you hear the audio guidance, follow the guidance to make the printer operations.*

5. Tap  to send the fax.

### Related Information

- ➔ [“Sending Faxes Dialing from the External Phone Device” on page 228](#)

## Sending Faxes Dialing from the External Phone Device

You can send a fax by dialing using the connected telephone when you want to talk over the phone before sending a fax, or when the recipient's fax machine does not switch to the fax automatically.

1. Pick up the handset of the connected telephone, and then dial the recipient's fax number using the phone.

**Note:**

*When the recipient answers the phone, you can talk with the recipient.*

2. Select **Fax** on the home screen.
3. Make necessary settings on the **Fax Settings**.

[“Fax Settings” on page 239](#)

4. When you hear a fax tone, tap , and then hang up the handset.

**Note:**

*When a number is dialed using the connected telephone, it takes longer to send a fax because the printer performs scanning and sending simultaneously. While sending the fax, you cannot use the other features.*

## Sending Faxes on Demand (Polling Send Box)

If you store a monochrome document in the printer's polling send box in advance, the stored document can be sent upon request from another fax machine that has a polling receive feature. You can store one document with up to 200 pages.

### Related Information

- ➔ [“Polling Send:” on page 246](#)

### Setting the Polling Send Box

You can store a document in the **Polling Send Box** without registering. Make the following settings as necessary.

1. Select **Fax Box > Polling Send/Board** from the home screen.

2. Select **Polling Send**, tap , and then select **Settings**.

**Note:**

*If a password entry screen is displayed, enter the password.*

3. Make the appropriate settings, such as **Notify Send Result**.

**Note:**

*If you set a password in **Box Open Password**, you will be asked to enter the password from the next time you open the box.*



4. Select **OK** to apply the settings.

### **Storing a Document in the Polling Send Box**

1. Select **Fax Box** on the home screen, and then select **Polling Send/Board**.

2. Select **Polling Send**.

If the password entry screen is displayed, enter the password to open the box.

3. Tap **Add Document**.

4. On the fax top screen that is displayed, check the fax settings, and then tap  to scan and store the document.

To check the document you stored, select **Fax Box > Polling Send/Board**, select the box containing the document you want to check, and then tap **Check Document**. On the screen that is displayed, you can view, print or delete the scanned document.

### **Sending Faxes on Demand (Bulletin Board Box)**

If you store a monochrome document in a printer's bulletin board box in advance, the stored document can be sent upon request from another fax machine that supports the subaddress/password feature. There are 10 bulletin board boxes in the printer. You can store one document with up to 200 pages in each box. To use a bulletin board box, at least one box to store a document must be registered beforehand.

#### **Related Information**

- ➔ [“Unregistered Bulletin Board:” on page 248](#)
- ➔ [“Each Registered Bulletin Board” on page 248](#)

### **Registering a Bulletin Board Box**

You must register a bulletin board box for storing a document beforehand. Follow the steps below to register the box.

1. Select **Fax Box > Polling Send/Board** from the home screen.

2. Select one of the boxes named **Unregistered Bulletin Board**.

**Note:**

*If a password entry screen is displayed, enter the password.*

3. Make settings for the items on the screen.

- Enter a name in **Name (Required)**
- Enter a subaddress in **Subaddress(SEP)**
- Enter a password in **Password(PWD)**

4. Make the appropriate settings such as **Notify Send Result**.

**Note:**

*If you set a password in **Box Open Password**, you will be asked to enter the password from the next time you open the box.*

5. Select **OK** to apply the settings.

To display the screen for changing settings or deleting registered boxes, select the box you want to change/delete, and then tap .

### **Storing a Document in the Bulletin Board Box**

1. Select **Fax Box** on the home screen, and then select **Polling Send/Board**.

2. Select one of the bulletin board boxes that have already been registered.

If the password entry screen is displayed, enter the password to open the box.

3. Tap **Add Document**.

4. On the fax top screen that is displayed, check the fax settings, and then tap  to scan and store the document.

To check the document you stored, select **Fax Box > Polling Send/Board**, select the box containing the document you want to check, and then tap **Check Document**. On the screen that is displayed, you can view, print or delete the scanned document.

### **Sending Many Pages of a Monochrome Document (Direct Send)**

When sending a fax in monochrome, the scanned document is temporarily stored in the printer's memory. Therefore, sending a lot of pages may cause the printer to run out of memory and stop sending the fax. You can avoid this by enabling the **Direct Send** feature, however, it takes longer to send the fax because the printer performs scanning and sending simultaneously. You can use this feature when there is only one recipient.

#### **Accessing the Menu**

You can find the menu on the printer's control panel below.

**Fax > Fax Settings > Direct Send**

### **Sending a Fax Preferentially (Priority Send)**

You can send an urgent document ahead of the other faxes waiting to be sent.

#### **Note:**

*You cannot send your document preferentially while one of the following is in progress because the printer cannot accept another fax.*

- Sending a monochrome fax with **Direct Send** enabled*
- Sending a color fax*
- Sending a fax by dialing from a connected telephone*
- Sending a fax sent from the computer (except when sending from memory)*

#### **Accessing the Menu**

You can find the menu on the printer's control panel below.

**Fax > Fax Settings > Priority Send.**

### Related Information

➔ [“Checking the Status or Logs for Fax Jobs” on page 250](#)

## Sending Faxes in Monochrome at Specified Time of the Day (Send Fax Later)

You can set to send a fax at a specified time. Only monochrome faxes can be sent when the time to send is specified.

### Accessing the Menu

You can find the menu on the printer's control panel below.

#### Fax > Fax Settings > Send Fax Later

Enable **Send Fax Later**, and then specify the time of day to send the fax.

#### Note:

To cancel the fax while the printer is waiting for the specified time to arrive, cancel it from .

### Related Information

➔ [“Checking the Status or Logs for Fax Jobs” on page 250](#)

## Sending Different Size Documents Using ADF (Continuous Scan(ADF))

Sending faxes by placing originals one by one, or by placing originals by size in the ADF, you can send them as one document at their original sizes of A4 or A5 size.

#### Note:

If you place a mix of different-sized originals in the ADF, the originals are sent at the width of the widest sheet among them and the length of each original.

1. Place the first batch of originals at the same size.
2. Select **Fax** on the home screen.
3. Specify the recipient.  
[“Selecting Recipients” on page 226](#)
4. Select the **Fax Settings** tab, and then tap **Continuous Scan(ADF)** to set this to **On**.  
You can also make settings such as the resolution and the sending method as necessary.
5. Tap  (**Send**).
6. When scanning the first set of originals is complete and a message is displayed on the control panel asking you to scan the next set of originals, set the next originals, and then select **Start Scanning**.

#### Note:

If you leave the printer untouched for the time set in **Wait Time for Next Original** after you have been prompted to set the next originals, the printer stops storing and starts sending the document.

## **Sending a Fax with a Subaddress(SUB) and Password(SID)**

You can send faxes to the confidential boxes or the relay boxes in the recipient's fax machine when the recipient's fax machine has the feature to receive confidential faxes or relay faxes. The recipients can receive them securely, or can forward them to specified fax destinations.

1. Place the originals.
2. Select **Fax** on the home screen.
3. Select **Contacts** and select a recipient with a registered subaddress and password.  
You can also select the recipient from **Recent** if it was sent with a subaddress and password.
4. Select the **Fax Settings** tab, and then make settings such as the resolution and the sending method as necessary.  
[“Fax Settings” on page 239](#)
5. Send the fax.

### **Related Information**

➔ [“Contacts Registration” on page 87](#)



## **Sending the Same Documents Multiple Times**

Since you can send faxes using documents stored in the printer, you can save the time spent scanning documents when you need to send the same document frequently. You can store up to 200 pages of a single document in monochrome. You can store 10 documents in the printer's stored documents box.

### **Note:**

*Saving 10 documents may not be possible depending on the usage conditions such as the file size of stored documents.*

## **Storing a Fax Without Specifying a Recipient (Store Fax Data)**

1. Place the originals.
2. Select **Fax Box** on the home screen.
3. Select **Stored Documents**, tap  (Box Menu), and then select **Store Fax Data**.
4. In the **Fax Settings** tab that is displayed, make settings such as the resolution as necessary.
5. Tap  to store the document.

After storing a document is complete, you can preview the scanned image by selecting **Fax Box > Stored**

**Documents** and then tapping the box for the document, or you can delete it by tapping  on the right of the box for the document.

### ***Sending Faxes Using the Stored Document Feature***

1. Select **Fax Box** on the home screen, and then select **Stored Documents**.
2. Select the document you want to send, check the content of the document, and then select **Start Sending**.  
When the message **Delete this document after sending?** is displayed, select **Yes** or **No**.
3. Specify the recipient.
4. Select the **Fax Settings** tab, and then make settings such as the sending method as necessary.  
“Fax Settings” on page 239
5. Tap  to send the fax.

### **Related Information**

- ➔ “Stored Documents:” on page 245
- ➔ “Checking the Status or Logs for Fax Jobs” on page 250

---

## **Receiving Faxes on the Printer**

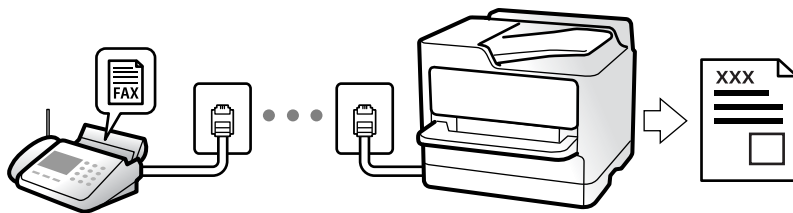

If the printer is connected to the phone line and basic settings have been completed using the Fax Setting Wizard, you can receive faxes.

You can save received faxes, check them on the printer screen, and forward them.

Received faxes are printed in the printer's initial settings.

When you want to check the status of the fax settings, print a **Fax Settings List** by selecting **Fax** >  (More) > **Fax Report** > **Fax Settings List**.

### **Note:**

- You cannot do the following while receiving a fax.
  - Receive other faxes at the same time
  - Send faxes
- You can perform fax sending operations (up to the stage of reserving a job) even while receiving a fax.  
However, you cannot perform operations for sending faxes for jobs that cannot be reserved, such as sending using **On Hook** or **Direct Send**.

## **Receiving Incoming Faxes**

There are two options in **Receive Mode**.

### Related Information

- ➔ [“Usage of Manual Mode” on page 234](#)
- ➔ [“Usage of Auto Mode” on page 234](#)

## Usage of Manual Mode

This mode is mainly for making phone calls, but is also for faxing.

### Receiving Faxes

When the telephone rings, you can answer the ringing manually by picking up the handset.

- When you hear a fax signal (baud):

Select **Fax** on the printer's home screen, select **Send/Receive > Receive**, and then tap . Once the printer starts receiving the fax, you can hang up the handset.

- If the ringing is for a voice call:

You can answer the phone as normal.

### Receiving Faxes Using only the Connected Telephone

When **Remote Receive** is set, you can receive faxes by simply entering the **Start Code**.

When the telephone rings, pick up the handset. When you hear a fax tone (baud), dial the two digit **Start Code**, and then hang up the handset. If you do not know the start code, ask the administrator.

## Usage of Auto Mode

This mode allows you to use the line for the following uses.

- Using the line for faxing only (external telephone is not necessary)
- Using the line for faxing mainly, and sometimes phoning

### Receiving Faxes Without an External Phone Device

The printer automatically switches to receive faxes when the number of rings you set in **Rings to Answer** is complete.

### Receiving Faxes With an External Phone Device

A printer with an external phone device works as follows.

- When the answering machine answers within the number of rings set in **Rings to Answer**:
  - If the ringing is for a fax: The printer automatically switches to receive faxes.
  - If the ringing is for a voice call; The answering machine can receive voice calls and record voice messages.

- ❑ When you pick up the handset within the number of rings set in **Rings to Answer**:
  - If the ringing is for a fax: Hold the line until the printer automatically starts receiving the fax. Once the printer starts receiving the fax, you can hang up the handset. To start receiving the fax immediately, use the same steps as for **Manual**. You can receive the fax using the same steps as for **Manual**. Select **Fax** on the home screen, and then select **Send/Receive** > **Receive**. Next, tap , and then hang up the handset.
  - If the ringing is for a voice call: You can answer the phone as normal.
- ❑ When the ringing stops and the printer automatically switches to receive faxes:
  - If the ringing is for a fax: The printer starts receiving faxes.
  - If the ringing is for a voice call: You cannot answer the phone. Ask the person to call you back.

**Note:**

Set the number of rings to answer for the answering machine to a lower number than the number set in **Rings to Answer**. Otherwise, the answering machine cannot receive voice calls to record voice messages. For details on setting up the answering machine, see the manual supplied with the answering machine.

## Receiving Faxes by Making a Phone Call

You can receive a fax stored on another fax machine by dialing the fax number.

### Related Information

- ➔ [“Receiving Faxes After Confirming the Sender's Status” on page 235](#)
- ➔ [“Receiving Faxes by Polling \(Polling Receive\)” on page 236](#)
- ➔ [“Receiving Faxes from a Board with a Subaddress \(SEP\) and Password \(PWD\) \(Polling Receive\)” on page 236](#)

## Receiving Faxes After Confirming the Sender's Status

You can receive a fax while listening to sounds or voices through the printer's speaker while dialing, communicating, and transmitting. You can use this feature when you want to receive a fax from a fax information service by following an audio guide.

1. Select **Fax** on the home screen.
2. Tap , and then specify the sender.

**Note:**

You can adjust the sound volume of the speaker.

3. Wait until the sender answers your call. When you hear a fax tone, select **Send/Receive** at the upper right corner of the LCD screen, and then select **Receive**.

**Note:**

When receiving a fax from a fax information service, and you hear the audio guidance, follow the guidance to make the printer operations.

4. Tap  to start receiving the fax.

## Receiving Faxes by Polling (Polling Receive)

You can receive a fax stored on another fax machine by dialing the fax number. Use this feature to receive a document from a fax information service.

**Note:**

- If the fax information service has an audio guidance feature that you need to follow to receive a document, you cannot use this feature.*
- To receive a document from a fax information service that uses audio guidance, just dial the fax number using the **On Hook** feature or the connected telephone, and operate the phone and the printer following the audio guidance.*

1. Select **Fax** on the home screen.
2. Tap  (More).
3. Select **Extended Fax**.
4. Tap the **Polling Receive** box to set this to **On**.
5. Tap **Close**, and then tap **Close** again.
6. Enter the fax number.



**Note:**

*If you cannot manually enter a fax number, **Direct Dialing Restrictions** in **Security Settings** is set to **On**. Select fax recipients from the contacts list or the sent fax history.*

7. Tap  to start **Polling Receive**.

## Receiving Faxes from a Board with a Subaddress (SEP) and Password (PWD) (Polling Receive)

By dialing to a sender, you can receive faxes from a board stored on sender's fax machine with a subaddress (SEP) and password (PWD) feature. To use this feature, register the contact with the subaddress (SEP) and password (PWD) in the contacts list in advance.

1. Select **Fax** on the home screen.
2. Select  (More).
3. Select **Extended Fax**.
4. Tap **Polling Receive** to set this to **On**.
5. Tap **Close**, and then tap **Close** again.
6. Select **Contacts**, and then select the contact with the registered subaddress (SEP) and password (PWD) to match the destination board.
7. Tap  to start **Polling Receive**.



## Related Information

➔ [“Contacts Registration” on page 87](#)

# Saving and Forwarding Received Faxes

## Summary of the Features

If your organization has a printer administrator, contact your administrator to check the status of the printer settings.

### Saving Received Faxes in the Printer

The received faxes can be saved in the printer, and you can view them on the printer's screen. You can print only the faxes you want to print or delete unnecessary faxes.

### Saving and/or Forwarding Received Faxes to Destinations Other than the Printer

The following can be set as destinations.

- Computer (PC-FAX reception)
- External memory device
- Email address
- Shared folder on a network
- Cloud service (online storage)
- Another fax machine

**Note:**

- Fax data is saved in PDF or TIFF format, except for cloud services and other fax machines.
- Fax data is saved in PDF or JPEG format for cloud services.

### Sorting Received Faxes by Conditions such as Subaddress and Password

You can sort and save received faxes to your Inbox or bulletin board boxes. You can also forward received faxes to destinations other than the printer.

- Email address
- Shared folder on a network
- Cloud service (online storage)
- Another fax machine

**Note:**

- Fax data is saved in PDF or TIFF format, except for cloud services and other fax machines.
- Fax data is saved in PDF or JPEG format for cloud services.
- You can print the save/forward conditions set in the printer. Select **Fax** on the home screen, and then select  (More) > **Fax Report** > **Conditional Save/Forward list**.

## Related Information

- ➔ [“Settings to Save and Forward Received Faxes” on page 123](#)
- ➔ [“Settings to Save and Forward Received Faxes with Specific Conditions” on page 126](#)
- ➔ [“Viewing Received Faxes on the Printer's LCD Screen” on page 238](#)

## Viewing Received Faxes on the Printer's LCD Screen

To view received faxes on the printer's screen, you must make settings on the printer in advance.

[“Making Saving Settings to Receive Faxes” on page 123](#)





1. Select **Fax Box** on the home screen.

**Note:**

When there are received faxes that have not been read, the number of unread documents is displayed on the  on the home screen.

2. Select **Inbox/Confidential**.
3. Select the inbox or the confidential box you want to view.
4. If the inbox, or the confidential box has been password protected, enter the inbox password, the confidential box password, or the administrator password.
5. Select the fax you want to view from the list.

The contents of the fax are displayed.

-  : Rotates the image to the right by 90 degrees.
  -  : Moves the screen in the direction of the arrows.
  -  : Reduces or enlarges.
  -  : Moves to the previous or the next page.
  -  : Displays menus such as save and forward.
  - To hide the operation icons, tap anywhere on the preview screen except for the icons. Tap again to display the icons.
6. Select whether to print or delete the document you have viewed, and then follow the on-screen instructions.



**Important:**

*If the printer runs out of memory, receiving and sending faxes is disabled. Delete documents that you have already read or printed.*

## Related Information

- ➔ [“Inbox/Confidential” on page 243](#)

## Menu Options for Faxing

### Recipient

Select the menus on the control panel as described below.

#### Fax > Recipient

##### Keypad:

Manually enter a fax number.

##### Contacts:

Select a recipient from the contacts list. You can also add or edit a contact.

##### Recent:

Select a recipient from the sent fax history. You can also add the recipient to the contacts list.

### Fax Settings

Select the menus on the control panel as described below.

#### Fax > Fax Settings

##### Quick Operation Button:

Assigning up to three frequently used items such as **Transmission Log** and **Original Type** in **Settings > General Settings > Fax Settings > Quick Operation Button**, displays the items at the top of the **Fax Settings** tab.

##### Scan Settings:

##### Resolution:

Select the resolution of the outgoing fax. If you select a higher resolution, the data size becomes larger and it takes time to send the fax.

##### Density:

Sets the density of the outgoing fax. + makes the density darker, and - makes it lighter.

##### Original Type:

Select the type of your original.

##### Remove Background:

Detects the paper color (background color) of the original document, and removes or lightens the color. Depending on the darkness and vividness of the color, it may not be removed or lightened

**Sharpness:**

Enhances or defocuses the outline of the image. + enhances the sharpness, and - defocuses the sharpness.

**ADF 2-Sided:**

Scans both sides of originals placed in the ADF and sends a monochrome fax.

**Continuous Scan(ADF):**

Sending faxes by placing originals one by one, or by placing originals by size, you can send them as one document at their original sizes.

[“Sending Different Size Documents Using ADF \(Continuous Scan\(ADF\)\)” on page 231](#)

**Original Size (Glass):**

Select the size and orientation of the original you placed on the scanner glass.

**Color Mode:**

Select whether to scan in color or in monochrome.

**Fax Send Settings:**

**Direct Send:**

Sends a monochrome fax while scanning the originals. Since scanned originals are not stored temporarily in the printer's memory even when sending a large volume of pages, you can avoid printer errors due to a lack of memory. Note that sending using this feature takes longer than not using this feature.

You cannot use this feature when:

- Sending a fax using the **ADF 2-Sided** option
- Sending a fax to multiple recipients

[“Sending Many Pages of a Monochrome Document \(Direct Send\)” on page 230](#)

**Priority Send:**

Sends the current fax before other faxes waiting to be sent.

[“Sending a Fax Preferentially \(Priority Send\)” on page 230](#)

**Send Fax Later:**

Sends a fax at a time you specified. Only a monochrome fax is available when using this option.

[“Sending Faxes in Monochrome at Specified Time of the Day \(Send Fax Later\)” on page 231](#)

#### Add Sender Information:

Add Sender Information

Select the position where you want to include the header information (sender name and fax number) in the outgoing fax, or not to include the information.

- **Off:** Sends a fax with no header information.

- **Outside of Image:** Sends a fax with header information in the top white margin of the fax. This keeps the header from overlapping with the scanned image, however, the fax received by the recipient may be printed across two sheets depending on the size of the originals.

- **Inside of Image:** Sends a fax with header information approximately 7 mm lower than the top of the scanned image. The header may overlap with the image, however, the fax received by the recipient will not be split into two documents.

Fax Header

Select the header for the recipient. To use this feature, you should register multiple headers in advance.

Additional Information

Select the information you want to add. You can select one from **Your Phone Number**, **Destination List**, and **None**.

#### Notify Send Result:

Sends a notification after you send a fax.

#### Recipient:

Select a recipient from the contacts list to send a notification after you have sent a fax.

#### Transmission Report:

Prints a transmission report after you send the fax.

**Print on Error** prints a report only when an error occurs.

When **Attach Fax image to report** has been set in **Settings > General Settings > Fax Settings > Report Settings**, faxes with errors are also printed with the report.

#### Backup:

Saves a backup of the sent fax that is scanned and saved to the printer's memory automatically. The backup feature is available when:

Sending a fax in monochrome

Sending a fax using the **Send Fax Later** feature

Sending a fax using the **Batch Send** feature

Sending a fax using the **Store Fax Data** feature

#### Backup Destination:

Select one of the following options, and then select a destination.

Email

Network Folder/FTP

Cloud

## More

Selecting  in **Fax** on the home screen displays the **More** menu.

### Transmission Log:

You can check the history of sent or received fax jobs.

Note that you can also check the history of sent or received fax jobs from **Job/Status**.

### Fax Report:

#### Last Transmission:

Prints a report for the previous fax that was sent or received through polling.

#### Fax Log:

Prints a transmission report. You can set to print this report automatically using the following menu.

**Settings > General Settings > Fax Settings > Report Settings > Fax Log Auto Print**

#### Stored Fax Documents:

Prints a list of fax documents stored in the printer's memory, such as unfinished jobs.

#### Fax Settings List:

Prints the current fax settings.

#### Conditional Save/Forward list:

Prints the Conditional Save/Forward List.

#### Protocol Trace:

Prints a detailed report for the previous fax that was sent or received.

### Extended Fax:

#### Polling Receive:

When this is set to **On** and you call the sender's fax number, you can receive documents from the sender's fax machine.

[“Receiving Faxes by Polling \(Polling Receive\)” on page 236](#)

When you leave the Fax menu, the setting returns to **Off** (default).

#### Polling Send/Board:

When this is set to **On** by selecting the polling send box or a bulletin board box, you can scan and store documents to the box you selected by tapping  on the **Fax Settings** tab.

You can store one document to the polling send box.

[“Sending Faxes on Demand \(Polling Send Box\)” on page 228](#)

You can store up to 10 documents to up to 10 bulletin boards in the printer, but you must register them from **Fax Box** before storing documents.

[“Sending Faxes on Demand \(Bulletin Board Box\)” on page 229](#)

When you leave the Fax menu, the setting returns to **Off** (default).

#### Store Fax Data:

When this is set to **On**, and you tap  on the **Fax Settings** tab, you can scan and store documents to the **Stored Documents** box. You can store up to 10 documents.

You can also scan and save documents to the **Stored Documents** box from **Fax Box**.

[“Storing a Fax Without Specifying a Recipient \(Store Fax Data\)” on page 232](#)

When you leave the Fax menu, the setting returns to **Off** (default).

#### Fax Box:

Accesses the **Fax Box** on the home screen.

Fax Box includes the following boxes.

- Inbox
- Confidential Boxes
- Stored Documents Box
- Polling Send Box
- Bulletin Board Box

[“Menu Options for Fax Box” on page 243](#)

#### Fax Settings:

Accesses **Settings > General Settings > Fax Settings**. Access the setting menu as a printer administrator.

[“Fax Settings” on page 369](#)

---

## Menu Options for Fax Box

### Inbox/Confidential

You can find **Inbox/Confidential** in **Fax Box** on the home screen.

#### Inbox and Confidential Boxes (List)

Inbox and confidential boxes are in **Fax Box > Inbox/Confidential**.

You can save up to 200 documents in the inbox and the confidential box in total.









You can use one Inbox and register up to 10 confidential boxes. The box name is displayed on the box. **Confidential XX** is the default name for each confidential box.

#### Inbox and Confidential Boxes

Displays the received faxes list by date received, sender name, and pages.

Tapping one of the faxes from the list opens the preview screen, and you can check the contents of the fax. You can print or delete the fax while you are previewing.

preview screen

-   : Reduces or enlarges.
-  : Rotates the image to the right by 90 degrees.
-     : Moves the screen in the direction of the arrows.
-   : Moves to the previous or the next page.

To hide the operation icons, tap anywhere on the preview screen except for the icons. Tap again to display the icons.

 (Preview menu)

- Save to Memory Device
- Forward(Email)
- Forward(Network Folder)
- Forward(Cloud)
- Send Fax
- Details

When the message **Delete When Complete** is displayed, select **On** to delete faxes after completing processes such as **Save to Memory Device** or **Forward(Email)**.

 (Box Menu)

Print All:

This is displayed only when there are stored faxes in the box. Prints all faxes in the box. Selecting **On** in **Delete When Complete** deletes all faxes when printing is complete.

Save All to Memory Device:

This is displayed only when there are stored faxes in the box. Saves all faxes to external memory devices in the box. Selecting **On** in **Delete When Complete** deletes all documents when saving is complete.

Delete All Reads:

This is displayed when there are documents in the box. Deletes all read documents in the box.

Delete All Unreads:

This is displayed when there are documents in the box. Deletes all unread documents in the box.

Delete All:

This is displayed only when there are stored faxes in the box. Deletes all faxes in the box.

Settings:

The following items are displayed when you select **Inbox > Box Menu > Settings**.



- Options when memory is full: Select one option to print or to decline incoming faxes after the Inbox is full.
- Inbox Password Settings: You can set a password or change it.
- Auto Delete Received Faxes: Selecting **On** automatically deletes received fax documents in the inbox after a certain period of time. When **Follow Fax Settings** is selected, the following settings are used.  
**Settings > General Settings > Fax Settings > Receive Settings > Save/Forward Settings > Common Settings > Box Document Delete Settings**

The following items are displayed when you select a confidential box and select **Box Menu > Settings**.

- Name: Enter a name for the confidential box.
- Box Open Password: You can set a password or change it.

#### Delete Box:

This item is displayed only when you select a confidential box and select **Box Menu**. Clears the current settings for Confidential Boxes and deletes all stored documents.

#### Related Information

- ➔ [“Settings to Save and Forward Received Faxes” on page 123](#)
- ➔ [“Settings to Save and Forward Received Faxes with Specific Conditions” on page 126](#)
- ➔ [“Checking the Fax Job History” on page 252](#)

## Stored Documents:

You can find **Stored Documents** in **Fax Box** on the home screen.

You can store up to 200 pages of a single document in monochrome, and up to 10 documents in the box. This allows you to save time spent scanning documents when you need to send the same document frequently.

#### Note:









*You may not be able to save 10 documents depending on the usage conditions such as the size of saved documents.*

#### Stored Documents Box

Displays the stored documents list with stored dates and pages.

Tapping one of the stored documents from the list displays the preview screen. Tap **Start Sending** to go to the fax sending screen, or tap **Delete** to delete the document while you are previewing.

#### preview screen

-   : Reduces or enlarges.
-  : Rotates the image to the right by 90 degrees.
-     : Moves the screen in the direction of the arrows.
-   : Moves to the previous or the next page.

To hide the operation icons, tap anywhere on the preview screen except for the icons. Tap again to display the icons.

 (Preview menu)

- Save to Memory Device
- Forward(Email)
- Forward(Network Folder)
- Forward(Cloud)
- Print

When the message **Delete When Complete** is displayed, select **On** to delete faxes after completing processes such as **Save to Memory Device** or **Forward(Email)**.

 (Box Menu)

Store Fax Data:

Displays the screen for the **Fax > Fax Settings** tab. Tapping  on the screen starts scanning documents to store to the Stored Documents Box.

Print All:

This is displayed only when there are stored faxes in the box. Prints all faxes in the box. Selecting **On** in **Delete When Complete** deletes all faxes when printing is complete.

Save All to Memory Device:

This is displayed only when there are stored faxes in the box. Saves all faxes to external memory devices in the box. Selecting **On** in **Delete When Complete** deletes all documents when saving is complete.

Delete All:

This is displayed only when there are stored faxes in the box. Deletes all faxes in the box.

Settings:

Box Open Password: You can set a password or change it.

**Related Information**

- ➔ [“Sending the Same Documents Multiple Times” on page 232](#)
- ➔ [“Checking the Fax Job History” on page 252](#)

## Polling Send/Board

You can find **Polling Send/Board** in **Fax Box** on the home screen.

There is a Polling Send Box and 10 bulletin boards. You can store up to 200 pages of a single document in monochrome, and one document in each box.

### Polling Send:

You can find **Polling Send** in **Fax Box > Polling Send/Board**.

### Polling Send Box:

Displays the setting items and values in **Settings** in  (Menu).

### Add Document:









Displays the screen for the **Fax > Fax Settings** tab. Tapping  on the screen starts scanning documents to store them in the box.

When a document is in the box, **Check Document** is displayed instead.

### Check Document:

Displays the preview screen when a document is in the box. You can print or delete the document while you are previewing.

#### preview screen

-   : Reduces or enlarges.
-  : Rotates the image to the right by 90 degrees.
-     : Moves the screen in the direction of the arrows.
-   : Moves to the previous or the next page.

To hide the operation icons, tap anywhere on the preview screen except for the icons. Tap again to display the icons.

#### (Preview menu)

- Save to Memory Device
- Forward(Email)
- Forward(Network Folder)
- Forward(Cloud)
- Send Fax

When the message **Delete When Complete** is displayed, select **On** to delete faxes after completing processes such as **Save to Memory Device** or **Forward(Email)**.

#### (Menu)

### Delete Document:

This item is displayed only when there is a stored document in the box. Deletes the document stored in the box.

### Settings:

- Box Open Password: You can set a password or change it.
- Delete Document After Sending: Setting this to **On** deletes the document in the box when the next request from a recipient to send the document (Polling Send) is completed.
- Notify Send Result: When **Email Notifications** is set to **On**, the printer sends a notification to the destination specified in **Recipient** when a request to send the document (Polling Send) is completed.

### Related Information

- ➔ [“Sending Faxes on Demand \(Polling Send Box\)” on page 228](#)
- ➔ [“Checking the Fax Job History” on page 252](#)

## Unregistered Bulletin Board:

You can find **Unregistered Bulletin Board** in **Fax Box > Polling Send/Board**. Select one of the **Unregistered Bulletin Board** boxes. After registering a board, the registered name is displayed on the box instead of **Unregistered Bulletin Board**.

You can register up to 10 bulletin boards.

#### Bulletin Board Box Settings:

##### Name (Required):

Enter a name for the bulletin board box.

##### Subaddress(SEP):

Set the **Subaddress(SEP)**. If the subaddress set in this item matches the subaddress on the destination fax machine, the fax can be received on the destination fax machine.

##### Password(PWD):

Set the **Password(PWD)**. If the password set in this item matches the password on the destination fax machine, the fax can be received on the destination fax machine.

##### Box Open Password:

Set or change the password used to open the box.

##### Delete Document After Sending:

Setting this to **On** deletes the document in the box when the next request from a recipient to send the document (Polling Send) is completed.

##### Notify Send Result:

When **Email Notifications** is set to **On**, the printer sends a notification to the **Recipient** when a request to send the document (Polling Send) is completed.

### Related Information

- ➔ [“Sending Faxes on Demand \(Bulletin Board Box\)” on page 229](#)
- ➔ [“Each Registered Bulletin Board” on page 248](#)

## Each Registered Bulletin Board

You can find bulletin boards in **Fax Box > Polling Send/Board**. Select the box for which the registered name is displayed. The name displayed on the box is the name registered in **Unregistered Bulletin Board**.

You can register up to 10 bulletin boards.

(Registered Bulletin Board Name)

Displays the setting values of the items in **Settings** in  (Menu).

Add Document:









Displays the screen for the **Fax > Fax Settings** tab. Tapping  on the screen starts scanning documents to store them in the box.

When a document is in the box, **Check Document** is displayed instead.

Check Document:

Displays the preview screen when a document is in the box. You can print or delete the document while you are previewing.

preview screen

-   : Reduces or enlarges.
-  : Rotates the image to the right by 90 degrees.
-     : Moves the screen in the direction of the arrows.
-   : Moves to the previous or the next page.

To hide the operation icons, tap anywhere on the preview screen except for the icons. Tap again to display the icons.

 (Preview menu)

- Save to Memory Device
- Forward(Email)
- Forward(Network Folder)
- Forward(Cloud)
- Send Fax

When the message **Delete When Complete** is displayed, select **On** to delete faxes after completing processes such as **Save to Memory Device** or **Forward(Email)**.

 (Menu)

Delete Document:

This item is displayed only when there is a stored document in the box. Deletes the document stored in the box.

Settings:

- Name (Required): Change the name used for the bulletin board box.
- Subaddress(SEP): Change the condition required for a recipient to receive faxes.
- Password(PWD): Change the password required for a recipient to receive faxes.
- Box Open Password: You can set a password or change it.
- Delete Document After Sending: Setting this to **On** deletes the document in the box when the next request from a recipient to send the document (Polling Send) is completed.

- Notify Send Result: When **Email Notifications** is set to **On**, the printer sends a notification to the destination specified in **Recipient** when a request to send the document (Polling Send) is completed.

**Delete Box:**

Deletes the selected box clearing the current settings and deleting all stored documents.

**Related Information**

- ➔ “Sending Faxes on Demand (Polling Send Box)” on page 228
- ➔ “Unregistered Bulletin Board:” on page 248
- ➔ “Checking the Fax Job History” on page 252

## Checking the Status or Logs for Fax Jobs

### Displaying Information when Received Faxes are Unprocessed (Unread/Not Printed/Not Saved/Not Forwarded)

When there are unprocessed received documents, the number of unprocessed jobs is displayed on the  on the home screen. See the table below for a definition of the "unprocessed".



**Important:**

*When the inbox is full, receiving faxes is disabled. You should delete the documents from the inbox once they have been checked.*

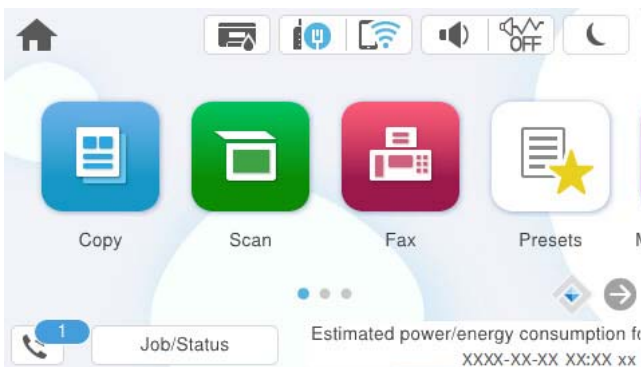

Received Fax Save/Forward Setting	Unprocessed Status
Printing*1	There are received documents waiting to be printed or printing is in progress.
Saving in the inbox or the confidential box	There are unread received documents in the inbox or the confidential box.
Saving in an external memory device	There are received documents that have not been saved in the device because there is no device containing a folder specifically created to save received documents connected to the printer or for other reasons.

Received Fax Save/Forward Setting	Unprocessed Status
Saving on a computer	There are received documents that have not been saved on the computer because the computer is in sleep mode or for other reasons.
Forwarding	There are received documents that have not been forwarded or failed to be forwarded*2.

\*1 : When you have not set any of the fax save/forward settings, or when you have set to print received documents while saving them to an external memory device or a computer.

\*2 : When you have set to save documents that could not be forwarded in the inbox, there are unread documents that failed to be forwarded in the inbox. When you have set to print documents that failed to be forwarded, printing is not complete.

**Note:**

*If you are using more than one of the fax save/forward settings, the number of unprocessed jobs may be displayed as "2" or "3" even if only one fax has been received. For example, if you have set to save faxes in the inbox and on a computer and one fax is received, the number of unprocessed jobs is displayed as "2" if the fax has not been saved to the inbox and on a computer.*

**Related Information**

- ➔ [“Viewing Received Faxes on the Printer's LCD Screen” on page 238](#)
- ➔ [“Checking Fax Jobs in Progress” on page 251](#)

## Checking Fax Jobs in Progress

You can display the screen to check fax jobs for which processing is incomplete. The following jobs are displayed on the check screen. From this screen, you can also print documents that have not yet been printed, or you can resend documents that have failed to send.

- Received fax jobs below
  - Not printed yet (When the jobs are set to be printed)
  - Not saved yet (When the jobs are set to be saved)
  - Not forwarded yet (When the jobs are set to be forwarded)
- Outgoing fax jobs that have failed to be sent (If you have enabled **Save Failure Data**)

Follow the steps below to display the check screen.

1. Tap **Job/Status** on the home screen.
2. Tap the **Job** tab, and then tap **Active**.
3. Select the job you want to check and select **Details**.

**Related Information**

- ➔ [“Displaying Information when Received Faxes are Unprocessed \(Unread/Not Printed/Not Saved/Not Forwarded\)” on page 250](#)

## Checking the Fax Job History

You can check the history of sent or received fax jobs, such as the date, time and result for each job.

1. Tap **Job/Status** on the home screen.
2. Select **Log** on the **Job** tab.
3. Tap ▼ on the right, and then select **Send** or **Receive**.

The log for sent or received fax jobs is displayed in reverse chronological order. Tap a job you want to check to display the details.

You can also check the fax history by printing **Fax Log** by selecting **Fax** >  (More) > **Fax Report** > **Fax Log**.

### Related Information

➔ [“More” on page 242](#)

## Reprinting Received Documents

You can reprint received documents from the logs of printed fax jobs.

Note that the printed received documents are deleted in chronological order when the printer runs out of memory.

1. Tap **Job/Status** on the home screen.
2. Select **Log** on the **Job** tab.
3. Tap ▼ on the right, and then select **Print**.

The history of sent or received fax jobs is displayed in reverse chronological order.

4. Select a job with  from the history list.  
Check the date, time, and result to determine if it is the document you want print.
5. Tap **Print Again** to print the document.

---

## Sending a Fax from a Computer

You can send faxes from the computer by using the FAX Utility and PC-FAX driver.

For details on how to operate FAX Utility, see Basic Operations in the FAX Utility help (displayed on the main window).



**Note:**

- ❑ Check if the FAX Utility and the printer's PC-FAX driver has been installed before using this feature.  
    “Application for Configuring Fax Operations and Sending Faxes (FAX Utility)” on page 354  
    “Application for Sending Faxes (PC-FAX Driver)” on page 355
- ❑ If the FAX Utility is not installed, install the FAX Utility using the EPSON Software Updater (application for updating software).  
    “Application for Updating Software and Firmware (Epson Software Updater)” on page 356

**Related Information**

- ➔ “Enabling Sending Faxes from a Computer” on page 132

## Sending Documents Created Using an Application (Windows)

By selecting a printer fax from the **Print** menu of an application like Microsoft Word or Excel, you can directly transmit data such as documents, drawings, and tables you have created, with a cover sheet.

**Note:**

The following explanation uses Microsoft Word as an example. The actual operation may differ depending on the application you use. For details, see the application's help.

1. Using an application, create a document to transmit by fax.  
    You can send up to 200 pages in monochrome or 100 pages in color including cover sheet in one fax transmission.
2. Click **Print** from the **File** menu.  
    The application's **Print** window appears.
3. Select **XXXXXX (FAX)** (where XXXXXX is your printer name) in **Printer**, and then check the settings for fax sending.  
    Specify **1** in **Number of copies**. Fax may not be transmitted correctly if you specify **2** or more.
4. Click **Printer Properties** or **Properties** if you want to specify **Paper Size**, **Orientation**, **Color**, **Image Quality**, or **Character Density**.  
    For details, see the PC-FAX driver help.
5. Click **Print**.

**Note:**

When Using FAX Utility for the first time, a window for registering your information is displayed. Enter the necessary information, and then click **OK**.

**Recipient Settings** screen of FAX Utility is displayed.

6. When you want to send other documents in the same fax transmission, select **Add documents to send** checkbox.  
    The screen for adding documents is displayed when you click **Next** in step 10.
7. Select **Attach a cover sheet** checkbox if necessary.

8. Specify a recipient.

- Selecting a recipient (name, fax number and so on) from **PC-FAX Phone Book**:

If the recipient is saved in the phone book, do the steps below.

- ➊ Click the **PC-FAX Phone Book** tab.
- ➋ Select the recipient from the list and click **Add**.

- Selecting a recipient (name, fax number and so on) from the contacts on the printer:

If the recipient is saved in the contacts on the printer, do the steps below.

- ➊ Click the **Contacts on Printer** tab.
- ➋ Select contacts from the list and click **Add** to proceed to **Add to Recipient** window.
- ➌ Select the contacts from the list displayed, and then click **Edit**.
- ➍ Add the personal data such as **Company/Corp.** and **Title** as necessary, and then click **OK** to return to the **Add to Recipient** window.
- ➎ As necessary, select the checkbox of **Register in the PC-FAX Phone Book** to save the contacts to **PC-FAX Phone Book**.
- ➏ Click **OK**.

- Specifying a recipient (name, fax number and so on) directly:

Do the steps below.

- ➊ Click the **Manual Dial** tab.
- ➋ Enter the necessary information.
- ➌ Click **Add**.

Furthermore, by clicking **Save to Phone Book**, you can save the recipient in the list under the **PC-FAX Phone Book** tab.

**Note:**

- If your printer's **Line Type** is set to **PBX** and the access code has been set to use # (hash) instead of entering the exact prefix code, enter # (hash). For details, see **Line Type** in **Basic Settings** from related information link below.
- If you have selected **Enter fax number twice** in the **Optional Settings** on the **FAX Utility** main screen, you need to enter the same number again when you click **Add** or **Next**.

The recipient is added to the **Recipient List** displayed in the upper part of the window.

9. Click **Sending options** tab, and make the transmission option settings.

- Transmission mode:**

Select how the printer transmits the document.

- **Memory Trans.:** Sends a fax by storing the data temporarily in the printer's memory. If you want to send a fax to multiple recipients or from multiple computers at the same time, select this item.

- **Direct Trans.:** Sends a fax without storing the data temporarily in the printer's memory. If you want to send a large volume of monochrome pages, select this item to avoid an error due to insufficient printer's memory.

- Time specification:**

Select **Specify the transmission time** to send a fax at a specific time, and then enter the time in **Transmission time**.

10. Click **Next**.

- When you have selected **Add documents to send** checkbox, follow the steps below to add documents in the **Document Merging** window.
  - ➊ Open a document you want to add, and then select the same printer (fax name) in the **Print** window. The document is added to the **Document List to Merge** list.
  - ➋ Click **Preview** to check the merged document.
  - ➌ Click **Next**.

**Note:**

The **Image Quality** and **Color** settings you have selected for the first document are applied to other documents.

- When you have selected **Attach a cover sheet** checkbox, specify the content of the cover sheet in the **Cover Sheet Settings** window.
  - ➊ Select a cover sheet from samples in the **Cover Sheet** list. Note that there is no function to create an original cover sheet or to add an original cover sheet to the list.
  - ➋ Enter the **Subject** and **Message**.
  - ➌ Click **Next**.

**Note:**

In the **Cover Sheet Settings** window, do the following as necessary.

- Click **Cover Sheet Formatting** if you want to change the order of the items on the cover sheet. You can select the cover sheet size in **Paper Size**. You can also select a cover sheet at a different size to the document being transmitted.
- Click **Font** if you want to change the font used for the text on the cover sheet.
- Click **Sender Settings** if you want to change the sender information.
- Click **Detailed Preview** if you want to check the cover sheet with the subject and the message you entered.

11. Check the transmission content and click **Send**.

Make sure the name and fax number of the recipient are correct before transmitting. Click **Preview** to preview the cover sheet and document to transmit.

Once transmission starts, a window displaying the transmission status appears.

**Note:**

- To stop transmitting, select the data, and click **Cancel** . You can also cancel using the printer's control panel.
- If an error occurs during transmission, the **Communication error** window appears. Check the error information and retransmit.
- The **Fax Status Monitor** screen (the screen mentioned above where you can check the transmission status) is not displayed if **Display Fax Status Monitor During Transmission** is not selected in the **Optional Settings** screen of the **FAX Utility** main screen.

**Related Information**

➔ [“Basic Settings” on page 370](#)

## Sending Documents Created Using an Application (Mac OS)

By selecting a fax-capable printer from the **Print** menu of a commercially available application, you can send data such as documents, drawings, and tables, you have created.

**Note:**

The following explanation uses *Text Edit*, a standard Mac OS application as an example.

1. Create the document you want to send by fax in an application.

You can send up to 100 pages in monochrome, or 100 pages in color including cover sheet, and up to a size of 2GB, in one fax transmission.

2. Click **Print** from the **File** menu.

The application's **Print** window is displayed.

3. Select your printer (fax name) in **Name**, click ▼ to display the detailed settings, check the print settings, and then click **OK**.

4. Make settings for each item.

Specify **1** in **Number of copies**. Even if you specify **2** or more, only 1 copy is sent.

**Note:**

*The page size of documents you can send is the same as the paper size you can fax from the printer.*

5. Select Fax Settings from the popup menu, and then make settings for each item.

See the PC-FAX driver's help for explanations on each setting item.

Click  at the bottom left of the window to open the PC-FAX driver's help.

6. Select the Recipient Settings menu, and then specify the recipient.

- Specifying a recipient (name, fax number, and so on) directly:

Click the **Add** item, enter the necessary information, and then click . The recipient is added to the Recipient List displayed in the upper part of the window.

If you have selected "Enter fax number twice" in the PC-FAX driver settings, you need to enter the same number again when you click .

If your fax connection line requires a prefix code, enter External Access Prefix.

**Note:**

*If your printer's Line Type is set to **PBX** and the access code has been set to use # (hash) instead of entering the exact prefix code, enter # (hash). For details, see Line Type in Basic Settings from Related Information link below.*

- Selecting a recipient (name, fax number, and so on) from the phone book:

If the recipient is saved in the phone book, click . Select the recipient from the list, and then click **Add** > **OK**.

If your fax connection line requires a prefix code, enter External Access Prefix.

**Note:**

*If your printer's Line Type is set to **PBX** and the access code has been set to use # (hash) instead of entering the exact prefix code, enter # (hash). For details, see Line Type in Basic Settings from Related Information link below.*

7. Check the recipient settings, and then click **Fax**.

Sending starts.

Make sure the name and fax number of the recipient are correct before transmitting.

**Note:**

- If you click the printer icon in Dock, the transmission status check screen is displayed. To stop sending, click the data, and then click **Delete**.
- If an error occurs during transmission, the **Sending failed** message is displayed. Check the transmission records on the **Fax Transmission Record** screen.
- Mixed paper size documents may not be sent correctly.

**Related Information**

➔ [“Basic Settings” on page 370](#)

## Receiving Faxes on a Computer

Faxes can be received by a printer and saved in PDF or TIFF format on a computer connected to the printer. Use the FAX Utility (application) to make settings.

For details on how to operate FAX Utility, see Basic Operations in the FAX Utility help (displayed on the main window). If the password entry screen is displayed on the computer screen while you are making settings, enter the password. If you do not know the password, contact your printer administrator.

**Note:**

- Check if the FAX Utility has been installed and the FAX Utility settings have been made before using this feature.  
[“Application for Configuring Fax Operations and Sending Faxes \(FAX Utility\)” on page 354](#)
- If the FAX Utility is not installed, install the FAX Utility using the EPSON Software Updater (application for updating software).  
[“Application for Updating Software and Firmware \(Epson Software Updater\)” on page 356](#)

 **Important:**

- To receive faxes on a computer, the **Receive Mode** on the printer's control panel must be set to **Auto**. Contact your administrator for information on the printer settings status. To make settings on the printer's control panel, select **Settings > General Settings > Fax Settings > Basic Settings > Receive Mode**.
- The computer set to receive faxes should always be on. Received documents are saved in the printer's memory temporarily before the documents are saved on the computer. If you turn off the computer, the printer's memory might become full as it cannot send the documents to the computer.
- The number of documents that have been temporarily saved to the printer's memory are displayed on the  on the home screen.
- To read the received faxes, you need to install a PDF viewer such as Adobe Reader in the computer.

**Related Information**

➔ [“Making Settings to Send and Receive Faxes on a Computer” on page 132](#)

## Checking for New Faxes (Windows)

By setting up a computer to save faxes received by the printer, you can check the processing status of received faxes, and whether or not there are any new faxes using the fax icon on the Windows task bar. By setting up the computer to display a notification when new faxes are received, a notification screen pops up near the Windows system tray, and you can check the new faxes.



**Note:**

- Received fax data saved to the computer is removed from the printer's memory.
- You need Adobe Reader to view the received faxes saved as PDF files.

## Using the Fax Icon on the Task Bar (Windows)

You can check for new faxes and the operation status by using the fax icon displayed on the Windows taskbar.

1. Check the icon.

- : Standing by.
- : Checking for new faxes.
- : Importing new faxes is complete.

2. Right-click the icon, and then click **View Receiving Fax Record**.

The **Receiving Fax Record** screen is displayed.

3. Check the date and the sender in the list, and then open the file received as a PDF or TIFF.

**Note:**

- Received faxes are automatically renamed using the following naming format.  
YYYYMMDDHHMMSS\_XXXXXXXXXX\_nnnnn (Year/Month/Day/Hour/Minute/Second\_sender's number)
- You can also open the received fax folder directly when you right-click the icon. For details, see **Optional Settings** in the FAX Utility or see its help (displayed on the main window).

While the fax icon indicates that it is standing by, you can check for new faxes instantly by selecting **Check new faxes now**.

## Using the Notification Window (Windows)

When you set to notify you the new faxes exist, a notification window is displayed near the task bar for each the fax.

1. Check the notification screen displayed on your computer screen.

**Note:**

The notification screen disappears if no operation is performed for a given length of time. You can change the notification settings such as the display time.

2. Click anywhere in the notification screen, except for the  button.

The **Receiving Fax Record** screen is displayed.

3. Check the date and the sender in the list, and then open the file received as a PDF or TIFF.

**Note:**

- Received faxes are automatically renamed using the following naming format.  
YYYYMMDDHHMMSS\_XXXXXXXXXX\_nnnnn (Year/Month/Day/Hour/Minute/Second\_sender's number)
- You can also open the received fax folder directly when you right-click the icon. For details, see **Optional Settings** in the FAX Utility or see its help (displayed on the main window).

## Checking for New Faxes (Mac OS)

You can check for new faxes using one of the following methods. This is available only on computers set to "Save" (save faxes on this computer).

- Open the received fax folder (specified in **Received Fax Output Settings**.)
- Open the Fax Receive Monitor and click **Check new faxes now**.
- Notification that new faxes have been received

Select the **Notify me of new faxes via a dock icon** in the **Fax Receive Monitor > Preferences** in the FAX Utility, the fax receive monitor icon on the Dock jumps to notify you that new faxes have arrived.

## Open the Received Fax Folder from Received Fax Monitor (Mac OS)

You can open the save folder from the computer specified to receive faxes when selecting "Save" (save faxes on this computer).

1. Click the received fax monitor icon on the Dock to open **Fax Receive Monitor**.
2. Select the printer and click **Open folder**, or double click the printer name.
3. Check the date and the sender in the file name, and then open the PDF file.

**Note:**

*Received faxes are automatically renamed using the following naming format.*

*YYYYMMDDHHMMSS\_XXXXXXXXXX\_nnnnn (Year/Month/Day/Hour/Minute/Second\_sender's number)*

*Information sent from the sender is displayed as the sender's number. This number may not be displayed depending on the sender.*

## Canceling the Feature that Saves Incoming Faxes to the Computer

You can cancel saving faxes to the computer by using the FAX Utility.

For details, see Basic Operations in the FAX Utility help (displayed on the main window).

**Note:**

- If there are any faxes that have not been saved to the computer, you cannot cancel the feature that saves faxes on the computer.*
- You cannot change settings that have been locked by your administrator.*
- You can also change the settings on the printer. Contact your administrator for information on canceling settings to save received faxes on the computer.*

### Related Information

- ➔ ["Making Save to Computer Setting not to Receive Faxes" on page 133](#)

---

# Maintaining the Printer

Checking the Status of Consumables. . . . .	261
Improving Print, Copy, Scan, and Fax Quality. . . . .	262
Cleaning the Printer. . . . .	270



## Checking the Status of Consumables

You can check the approximate ink levels and the approximate service life of the maintenance box from the printer's control panel. Select  on the home screen.

**Note:**

The following indicates the amount of free space in the maintenance box.

A:Free space

B:Amount of waste ink

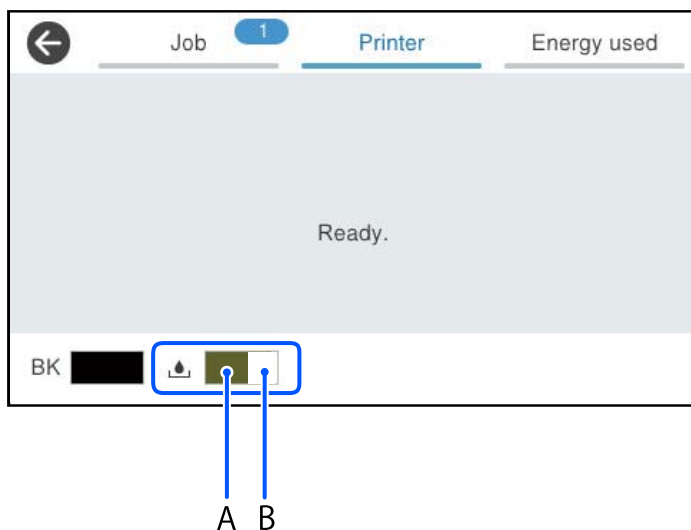

You can continue printing while the ink low message is displayed. Replace the ink supply unit when required.

**Note:**

You can also check the approximate ink level and the approximate service life of the maintenance box from the status monitor on the printer driver.

Windows

Click **EPSON Status Monitor 3** on the **Maintenance** tab.

If **EPSON Status Monitor 3** is disabled, click **Extended Settings** on the **Maintenance** tab, and then select **Enable EPSON Status Monitor 3**.

Mac OS

Apple menu > **System Preferences** > **Printers & Scanners** (or **Print & Scan**, **Print & Fax**) > Epson(XXXX) > **Options & Supplies** > **Utility** > **Open Printer Utility** > **EPSON Status Monitor**

### Related Information

➔ [“It is Time to Replace Ink Supply Units” on page 331](#)

➔ [“It is Time to Replace the Maintenance Box” on page 333](#)

# Improving Print, Copy, Scan, and Fax Quality

## Adjusting the Print Quality

If you notice a misaligned vertical lines, blurred images, or horizontal banding, adjust the print quality.

1. Select **Maintenance** on the printer's control panel.
2. Select **Print Quality Adjustment**.
3. Follow the on-screen instructions to print the alignment pattern and scan it.

Adjustments are performed automatically.

If the print quality does not improve, the message to print the maintenance check sheet is displayed on the control panel. Go to the next step.

4. Follow the on-screen instructions to print the maintenance check sheet.
5. Check each pattern to perform adjustments.

- For this pattern, if you cannot see any broken lines or missing segments as in the following "OK" pattern, select **OK**.

If there are broken lines or missing segments as shown in the "NG" pattern, select **Not GOOD**, and then follow the on-screen instructions..

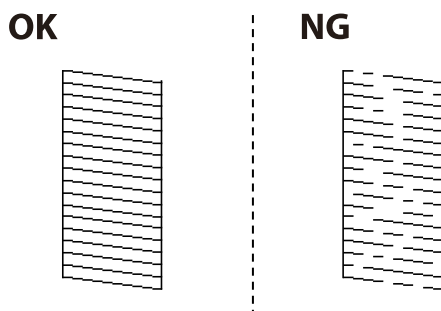

- For these patterns, if the left pattern looks the same as the right one with the check mark, select **OK**. If they look different, select **Not GOOD**, and then follow the on-screen instructions.

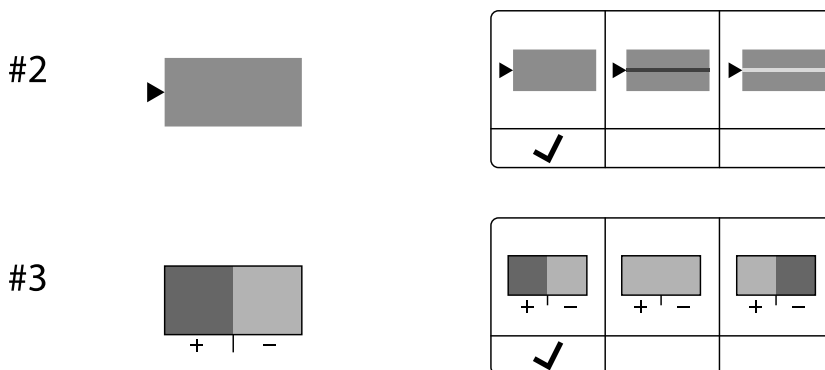

## Checking and Cleaning the Print Head

If the nozzles are clogged, the printouts become faint or there is visible banding. If the nozzles are severely clogged, a blank sheet will be printed. When print quality has declined, first use the nozzle check feature to check if the nozzles are clogged. If the nozzles are clogged, clean the print head.

**!** **Important:**

- Do not open the ink cover or turn off the printer during head cleaning. If the head cleaning is incomplete, you may not be able to print.
- Head cleaning consumes ink and should not be performed more than necessary.
- When ink is low, you may not be able to clean the print head.
- If print quality has not improved after repeating nozzle check and head cleaning 3 times, wait for at least 12 hours without printing, run the nozzle check once again, and then repeat head cleaning if necessary. We recommend turning off the printer by using the  button. If print quality has still not improved, contact Epson support.
- To prevent the print head from drying out, do not unplug the printer while the power is on.

You can check and clean the print head by using the printer's control panel.

1. Select **Maintenance** on the printer's control panel.
2. Select **Print Head Nozzle Check**.
3. Follow the on-screen instructions to load paper and print the nozzle check pattern.
4. Examine the printed pattern.
  - If there are broken lines or missing segments as shown in the "NG" pattern, the print head nozzles may be clogged. Go to the next step.
  - If you cannot see any broken lines or missing segments as in the following "OK" pattern, the nozzles are not clogged. Print head cleaning is not necessary. Select  to exit.

**OK**

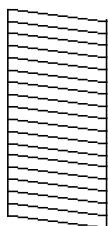

**NG**

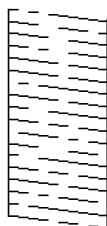

5. Select .
6. Follow the on-screen instructions to clean the print head.
7. When cleaning is finished, follow the on-screen instructions to print the nozzle check pattern again. Repeat cleaning and printing the pattern until all lines are printed completely.

**Note:**

You can also check and clean the print head from the printer driver.

**Windows**

Click **Print Head Nozzle Check** on the **Maintenance** tab.

**Mac OS**

Apple menu > **System Preferences** > **Printers & Scanners** (or **Print & Scan**, **Print & Fax**) > **Epson(XXXX)** > **Options & Supplies** > **Utility** > **Open Printer Utility** > **Print Head Nozzle Check**

## Preventing nozzle clogging

Always use the power button when turning the printer on and off.

Check that the power light is off before you disconnect the power cord.

The ink itself can dry out if it is not covered. Just like placing a cap on a fountain pen or an oil pen to prevent it from drying, make sure the print head is capped properly to prevent the ink from drying.

When the power cord is unplugged or a power outage occurs while the printer is in operation, the print head may not be capped properly. If the print head is left as it is, it will dry out causing nozzles (ink outlets) to clog.

In these cases, turn the printer on and off again as soon as possible to cap the print head.

## Aligning the Print Head

If you notice a misalignment of vertical lines or blurred images, align the print head.

1. Select **Maintenance** on the printer's control panel.
2. Select **Print Head Alignment**.
3. Select one of the alignment menus.
  - Vertical lines look misaligned or the printouts look blurry : Select **Ruled Line Alignment**.
  - Horizontal banding occurs at regular intervals: Select **Horizontal Alignment**.
4. Follow the on-screen instructions.

## Cleaning the Paper Path for Ink Smears

When the printouts are smeared or scuffed, clean the roller inside.



**Important:**

*Do not use tissue paper to clean the inside of the printer. The print head nozzles may be clogged with lint.*

1. Select **Maintenance** on the printer's control panel.
2. Select **Paper Guide Cleaning**.
3. Follow the on-screen instructions to load paper and clean the paper path.
4. Repeat this procedure until the paper is not smeared with ink.

## Cleaning the Scanner Glass

When the copies or scanned images are smeared, clean the scanner glass.



**Caution:**

*Be careful not to trap your hand or fingers when opening or closing the document cover. Otherwise you may be injured.*



**Important:**

*Never use alcohol or thinner to clean the printer. These chemicals can damage the printer.*

1. Open the document cover.

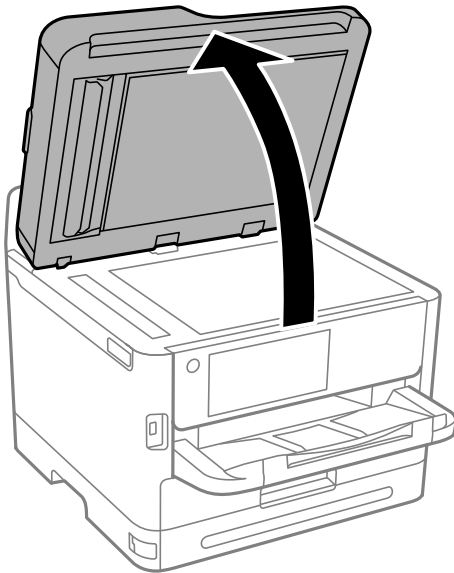

2. Use a soft, dry, clean cloth to clean the surface of the scanner glass.



**Important:**

- If the glass surface is stained with grease or some other hard-to-remove material, use a small amount of glass cleaner and a soft cloth to remove it. Wipe off all remaining liquid.*
- Do not press the glass surface too hard.*
- Be careful not to scratch or damage the surface of the glass. A damaged glass surface can decrease the scan quality.*

## Cleaning the ADF

When the copied or scanned images from the ADF are smeared or the originals do not feed in the ADF correctly, clean the ADF.



**Important:**

*Never use alcohol or thinner to clean the printer. These chemicals can damage the printer.*

1. Open the ADF cover.

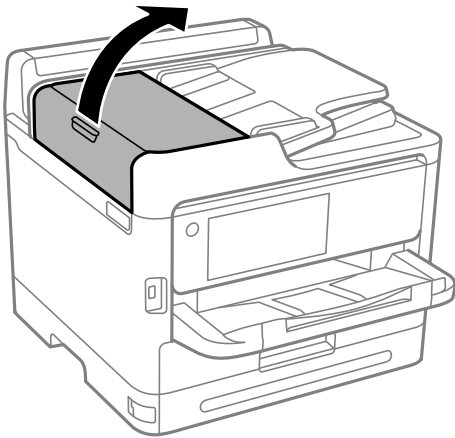

2. Use a soft, moist cloth to clean the roller and the interior of the ADF.

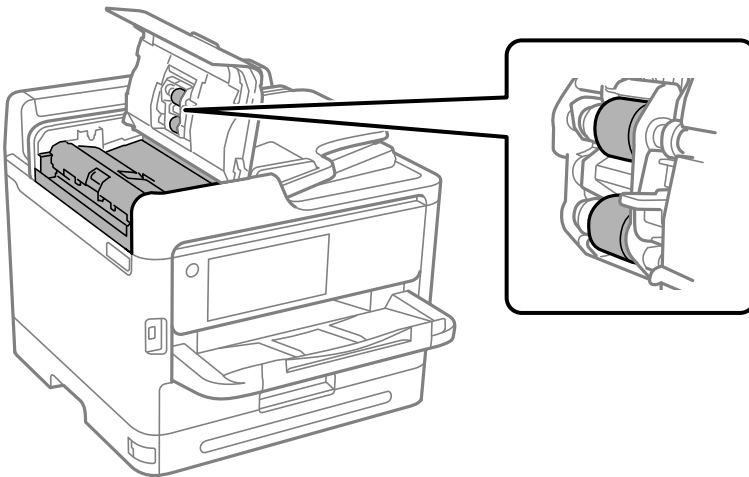

**!** *Important:*

- Using a dry cloth may damage the surface of the roller.*
- Use the ADF after the roller has dried.*

3. Close the ADF cover, and then open the document cover.

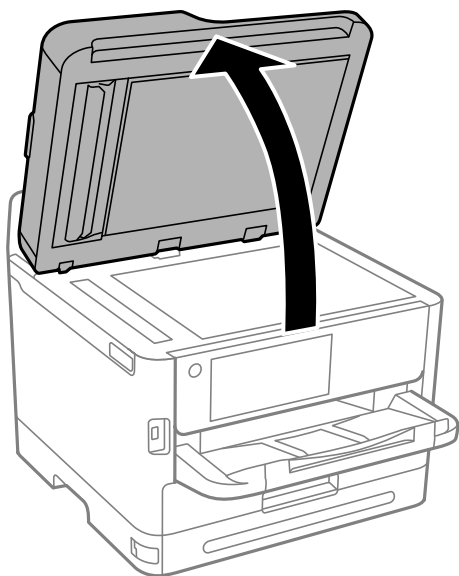

4. Clean the part that is shown in the illustration.  
Repeat cleaning until there is no dirt remaining.

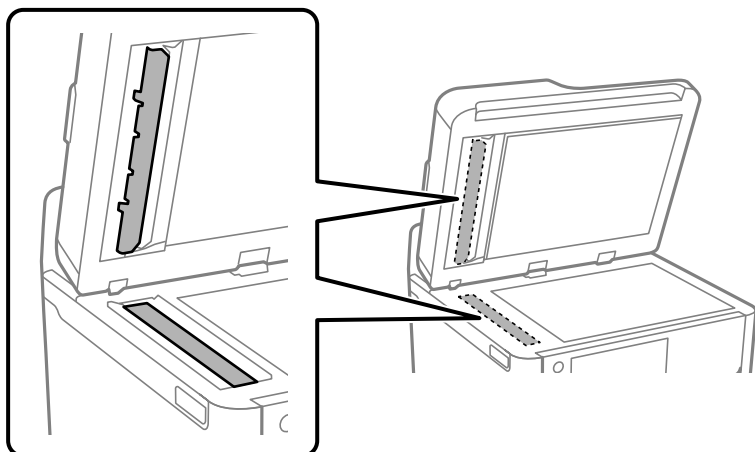

**Important:**

- ❑ After cleaning off the dirt, wipe off all remaining liquid.
- ❑ If the glass surface is stained with grease or some other hard-to-remove material, use a small amount of glass cleaner and a soft cloth to remove it.
- ❑ Do not press the glass surface too hard.
- ❑ Be careful not to scratch or damage the surface of the glass. A damaged glass surface can decrease the scan quality.

**Note:**

If a black line appears when copying from the ADF, location (B) shown in the illustration below may be dirty.

Place the copy result on the scanner glass and wipe away any dirt on the surface of the glass at the point extending from where the black line appears in the copy result. Be sure to wipe the same point on the opposite surface as well.

(A) Copy result where the black line appeared, (B) position with dirt

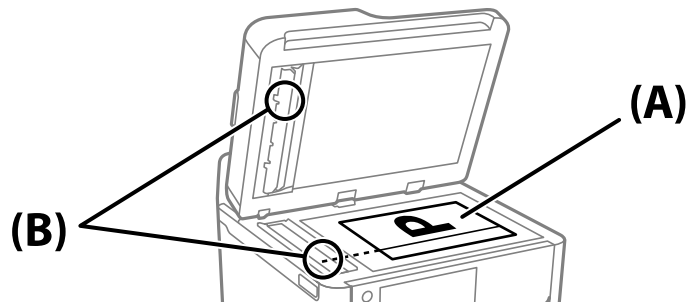

## Cleaning the Translucent Film

When the printout is not improved after aligning the print head or cleaning the paper path, the translucent film inside the printer may be smeared.

Items required:

- Cotton swabs (several)
- Water with a few drops of detergent (2 to 3 drops of detergent in 1/4 cup of tap water)
- Light for checking smears

**! Important:**

Do not use cleaning liquid other than water with a few drops of detergent.

1. Turn off the printer by pressing the  button.
2. Open the scanner unit.

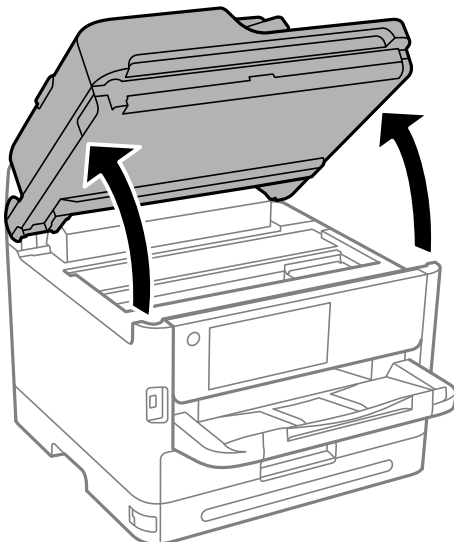



3. Check if the translucent film is smeared. Smears are easier to see if you use a light.  
If there are smears (such as finger marks or grease) on the translucent film (A), go to the next step.

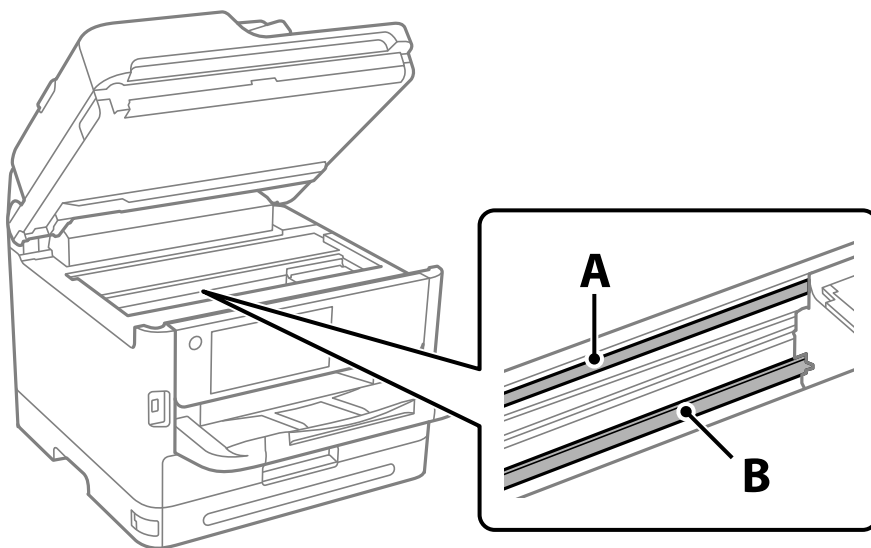

A: Translucent film

B: Rail

**!** *Important:*

*Be careful not to touch the rail (B). Otherwise, you may not be able to print. Do not wipe off the grease on the rail, because this is necessary for operations.*

4. Moisten a cotton swab with the water with a few drops of detergent so that it is not dripping water, and then wipe the smeared part.  
Be careful not to touch the ink that has adhered inside the printer.

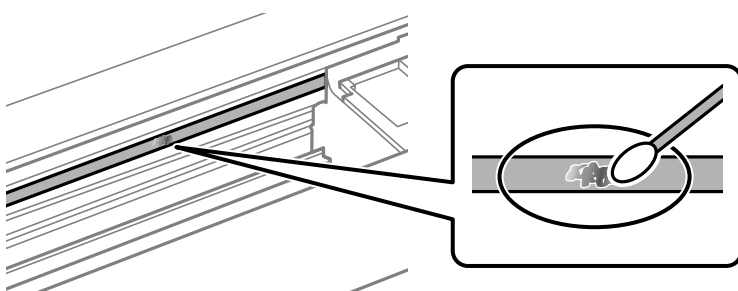

**!** *Important:*

*Wipe off the smear gently. If you press the cotton swab too hard to the film, the springs of the film may be dislocated and the printer may be damaged.*

5. Use a new dry cotton swab to wipe the film.

**!** *Important:*

*Do not leave any fibers on the film.*

**Note:**

To prevent the smear from spreading, frequently replace the cotton swab with a new one.

6. Repeat steps 4 and 5 until the film is not smeared.
7. Visually check that the film is not smeared.

---

## Cleaning the Printer

If the components and the case are dirty or dusty, turn off the printer and clean them using a soft, clean cloth that has been dampened with water. If you cannot remove the dirt, try adding a small amount of mild detergent to the damp cloth.

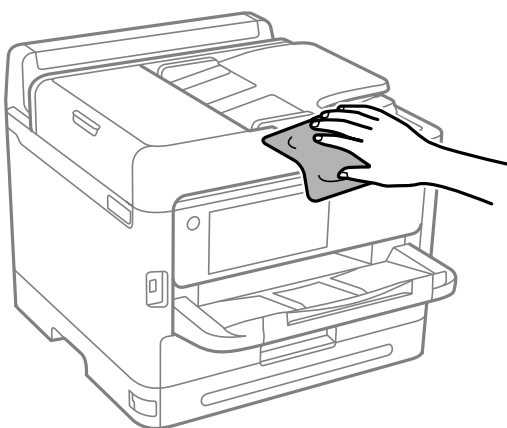

**!** **Important:**

- Be careful not to get water onto the printer mechanism or any electrical components. Otherwise, the printer could be damaged.
- Never use alcohol or paint thinner to clean the components and the case. These chemicals can damage them.
- Do not touch the parts shown in the following illustration. Doing so may cause a malfunction.

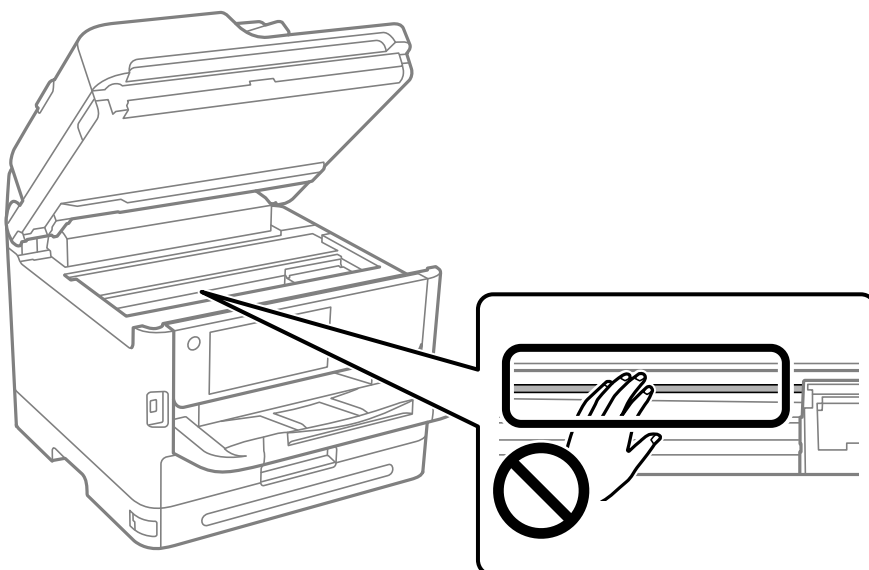

---

# In These Situations

When the Software Disk is not Available. . . . .	272
When Replacing a Computer. . . . .	272
Installing or Uninstalling Applications Separately. . . . .	272
Making Settings for Connecting to the Computer. . . . .	278
Checking the Printer's Network Connection Status (Network Connection Report). . . . .	278
Connecting a Smart Device and Printer Directly (Wi-Fi Direct). . . . .	279
Changing the Connection from Wi-Fi to USB. . . . .	282
Using a Printer with the Access Control Feature Enabled. . . . .	283
Transporting and Storing the Printer. . . . .	285

---

## When the Software Disk is not Available

The following should only be performed if user operations are permitted.

You can download the same contents as found on the software disk from the Internet.

This is useful if your computer does not have a CD/DVD drive, or if you have lost the software disc that was supplied with the product.

Access the following website, and then enter the product name. Go to **Setup**, and then start setting up. Follow the on-screen instructions.

<https://epson.sn>

---

## When Replacing a Computer

The following should only be performed if user operations are permitted.

You need to install the printer driver and other software on the new computer.

Access the following website, and then enter the product name. Go to **Setup**, and then start setting up. Follow the on-screen instructions.

<https://epson.sn>

---

## Installing or Uninstalling Applications Separately

Connect your computer to the network and install the latest version of applications from the website. Log in to your computer as an administrator. Enter the administrator password if the computer prompts you.

### Installing the Applications Separately

**Note:**

- When reinstalling an application, you need to uninstall it first.*
- You can download the latest applications from the Epson website.*  
<http://www.epson.com>
- If you use Windows Server operating systems, you cannot use Epson Software Updater. Download the latest applications from the Epson website.*

1. Make sure the printer and the computer are available for communication, and the printer is connected to the Internet.

2. Start EPSON Software Updater.

The screenshot is an example on Windows.

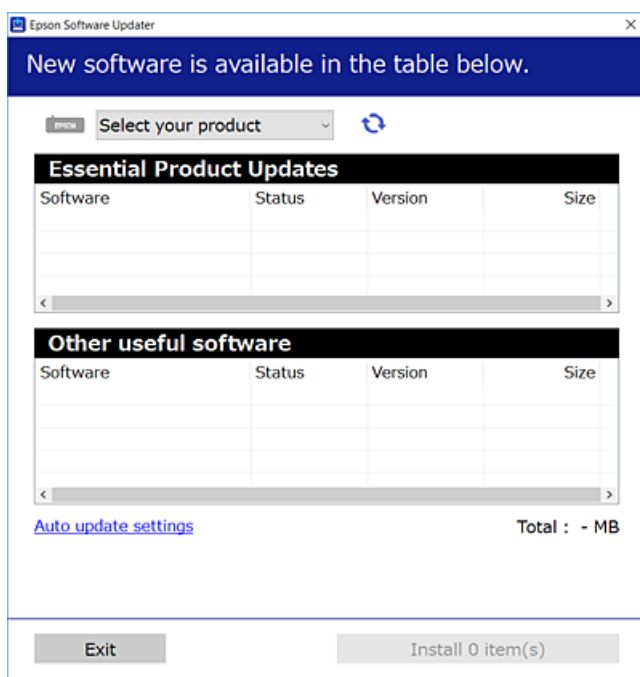

3. For Windows, select your printer, and then click  to check for the latest available applications.
4. Select the items you want to install or update, and then click the install button.



**Important:**

*Do not turn off or unplug the printer until the update is complete. Doing so may result in malfunction of the printer.*

**Related Information**

- ➔ [“Application for Updating Software and Firmware \(Epson Software Updater\)” on page 356](#)
- ➔ [“Uninstalling Applications” on page 276](#)

## Checking if a genuine Epson printer driver is installed - Windows

You can check if a genuine Epson printer driver is installed on your computer by using one of the following methods.

Select **Control Panel > View devices and printers (Printers, Printers and Faxes)**, and then do the following to open the print server properties window.

- ❑ Windows 11/Windows 10/Windows 8.1/Windows 8/Windows 7/Windows Server 2022/Windows Server 2019/Windows Server 2016/Windows Server 2012 R2/Windows Server 2012/Windows Server 2008 R2

Click the printer icon, and then click **Print server properties** at the top of the window.

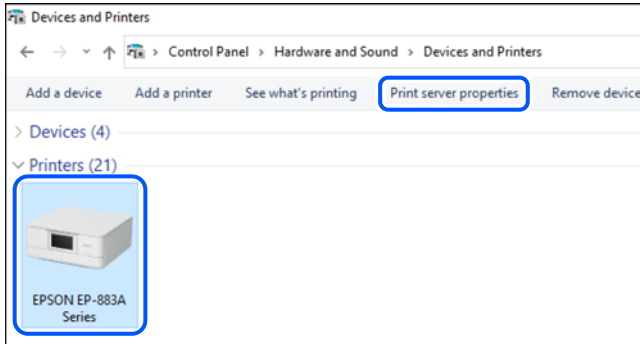

- ❑ Windows Vista/Windows Server 2008  
Right-click on the **Printers** folder, and then click **Run as administrator > Server Properties**.
- ❑ Windows XP/Windows Server 2003 R2/Windows Server 2003  
From the **File** menu, select **Server Properties**.

Click the **Drivers** tab. If your printer name is displayed in the list, a genuine Epson printer driver is installed on your computer.

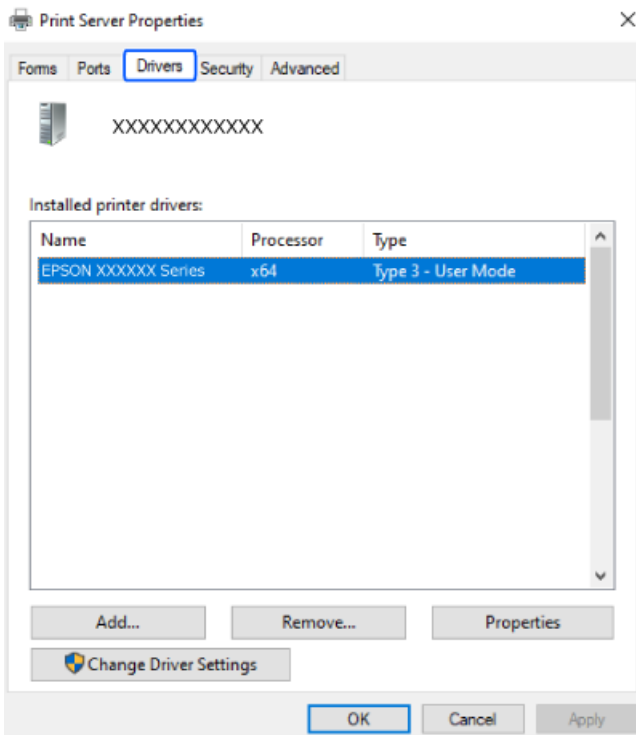

### Related Information

- ➔ [“Installing the Applications Separately” on page 272](#)

## Checking if a genuine Epson printer driver is installed - Mac OS

You can check if a genuine Epson printer driver is installed on your computer by using one of the following methods.

Select **System Preferences** from the Apple menu > **Printers & Scanners** (or **Print & Scan, Print & Fax**), and then select the printer. Click **Options & Supplies**, and if the **Options** tab and **Utility** tab are displayed on the window, a genuine Epson printer driver is installed on your computer.

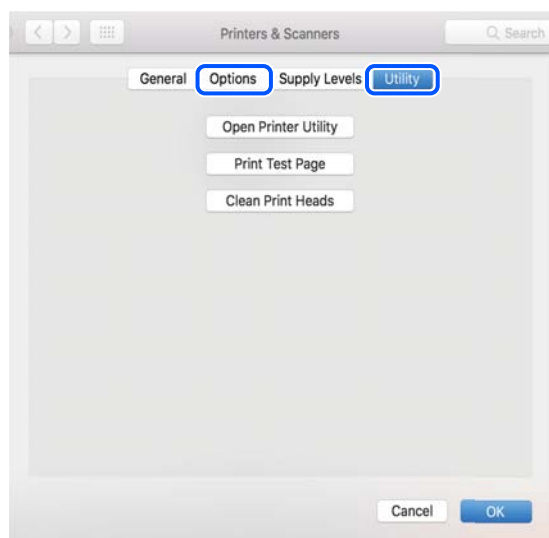

### Related Information

➔ [“Installing the Applications Separately” on page 272](#)

## Installing a PostScript Printer Driver

### Installing a PostScript Printer Driver - Windows

1. Start the installation process from one of the following options.
  - Use the software disc supplied with the printer.**

Insert the software disc into the computer, access the following folder path, and then run SETUP64.EXE (or SETUP.EXE).

Driver\PostScript\WINX64 (or WINX86)\SETUP\SETUP64.EXE ( or SETUP.EXE)
  - Download from the website.**

Access your printer page from the following website, download the PostScript printer driver, and then run the execution file.

<http://www.epson.eu/Support> (Europe)

<http://support.epson.net/> (outside Europe)
2. Select your printer.
3. Follow the on-screen instructions.

4. Select the connection method from the network connection or USB connection.

**For network connection.**

A list of available printers in the same network is displayed.

Select the printer you want to use.

**For USB connection.**

Follow the on-screen instructions to connect the printer to the computer.

5. Follow the on-screen instructions to install the PostScript printer driver.

## Installing a PostScript Printer Driver - Mac OS

Download the printer driver from the Epson Support website, and then install it.

<http://www.epson.eu/Support> (Europe)

<http://support.epson.net/> (outside Europe)

You need the IP address of the printer while installing the printer driver.

Select the network icon on the printer's home screen, and then select the active connection method to confirm the printer's IP address.

## Adding a Genuine Epson Printer (for Mac OS Only)

1. Select **System Preferences** from the Apple menu > **Printers & Scanners** (or **Print & Scan, Print & Fax**).

2. Click **+**, and then select your printer on the screen displayed.

3. Make the following settings.

macOS Monterey (12.x) or later

Click **Select Software** from **Use**, select your printer on the screen displayed, and then click **OK**.

Mac OS X Mavericks (10.9.5) to macOS Big Sur (11.x)

Select your printer from **Use**.

4. Click **Add**.

**Note:**

*If your printer is not listed, check that it is correctly connected to the computer and that the printer is on.*

*For a USB, IP, or Bonjour connection, set the optional paper cassette unit manually after adding the printer.*

## Uninstalling Applications

Log in to your computer as an administrator. Enter the administrator password if the computer prompts you.

## Uninstalling Applications - Windows

1. Press the  button to turn off the printer.



2. Quit all running applications.
  3. Open **Control Panel**:
    - Windows 11  
Click on the start button, and then select **All apps > Windows Tools > Control Panel**.
    - Windows 10/Windows Server 2022/Windows Server 2019/Windows Server 2016  
Click on the start button, and then select **Windows System > Control Panel**.
    - Windows 8.1/Windows 8/Windows Server 2012 R2/Windows Server 2012  
Select **Desktop > Settings > Control Panel**.
    - Windows 7/Windows Vista/Windows XP/Windows Server 2008 R2/Windows Server 2008/Windows Server 2003 R2/Windows Server 2003  
Click the start button and select **Control Panel**.
  4. Open **Uninstall a program** (or **Add or Remove Programs**):
    - Windows 11/Windows 10/Windows 8.1/Windows 8/Windows 7/Windows Vista/Windows Server 2022/Windows Server 2019/Windows Server 2016/Windows Server 2012 R2/Windows Server 2012/Windows Server 2008 R2/Windows Server 2008  
Select **Uninstall a program** in **Programs**.
    - Windows XP/Windows Server 2003 R2/Windows Server 2003  
Click **Add or Remove Programs**.
  5. Select the application you want to uninstall.  
You cannot uninstall the printer driver if there is any print jobs. Delete or wait to be printed the jobs before uninstalling.
  6. Uninstall the applications:
    - Windows 11/Windows 10/Windows 8.1/Windows 8/Windows 7/Windows Vista/Windows Server 2022/Windows Server 2019/Windows Server 2016/Windows Server 2012 R2/Windows Server 2012/Windows Server 2008 R2/Windows Server 2008  
Click **Uninstall/Change** or **Uninstall**.
    - Windows XP/Windows Server 2003 R2/Windows Server 2003  
Click **Change/Remove** or **Remove**.
- Note:**  
*If the **User Account Control** window is displayed, click **Continue**.*
7. Follow the on-screen instructions.

## Uninstalling Applications - Mac OS

1. Download the Uninstaller using EPSON Software Updater.  
Once you have downloaded the Uninstaller, you do not need to download it again each time you uninstall the application.
2. Press the  button to turn off the printer.

3. To uninstall the printer driver or PC-FAX driver, select **System Preferences** from the Apple menu > **Printers & Scanners** (or **Print & Scan, Print & Fax**), and then remove the printer from the enabled printers list.
4. Quit all running applications.
5. Select **Go > Applications > Epson Software > Uninstaller**.
6. Select the application you want to uninstall, and then click **Uninstall**.



**Important:**

*The Uninstaller removes all drivers for Epson inkjet printers on the computer. If you use multiple Epson inkjet printers and you only want to delete some drivers, delete all of them first, and then install the necessary printer driver again.*

**Note:**

*If you cannot find the application you want to uninstall in the application list, you cannot uninstall using the Uninstaller. In this situation, select **Go > Applications > Epson Software**, select the application you want to uninstall, and then drag it to the trash icon.*

**Related Information**

➔ [“Application for Updating Software and Firmware \(Epson Software Updater\)” on page 356](#)

---

## Making Settings for Connecting to the Computer

Follow any instructions from your administrator regarding how to connect the printer.

Access the following website, and then enter the product name. Go to **Setup**, and then start setting up.

<https://epson.sn>

To configure a shared printer on the network, select a printer found on the network and begin configuration.

---

## Checking the Printer's Network Connection Status (Network Connection Report)

You can print a network connection report to check the status between the printer and the wireless router.

1. Tap  on the home screen.
2. Select **Description > When you cannot connect to the network > Connection Check**.  
The connection check starts.
3. Follow the instructions on the printer's screen to print the network connection report.  
If an error has occurred, contact your administrator.

**Related Information**

➔ [“Messages and Solutions on the Network Connection Report” on page 58](#)

## Connecting a Smart Device and Printer Directly (Wi-Fi Direct)

Wi-Fi Direct (Simple AP) allows you to connect a smart device directly to the printer without a wireless router and print from the smart device.

### About Wi-Fi Direct

Use this connection method when you are not using Wi-Fi at home or at the office, or when you want to connect the printer and the computer or smart device directly. In this mode, the printer acts as an wireless router and you can connect the devices to the printer without having to use a standard wireless router. However, devices directly connected to the printer cannot communicate with each other through the printer.

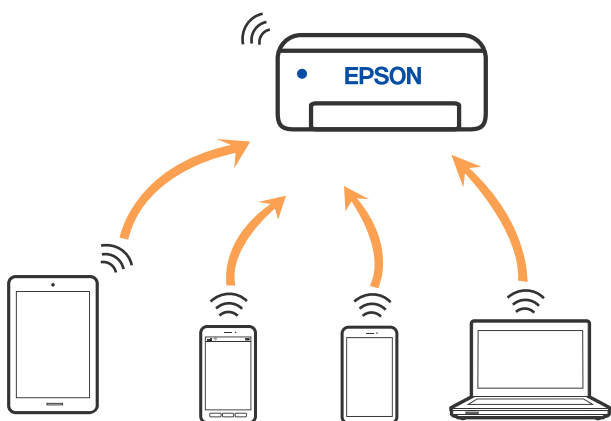

The printer can be connected by Wi-Fi or Ethernet, and Wi-Fi Direct (Simple AP) connection simultaneously. However, if you start a network connection in Wi-Fi Direct (Simple AP) connection when the printer is connected by Wi-Fi, the Wi-Fi is temporarily disconnected.

### Connecting to Devices using Wi-Fi Direct

This method allows you to connect the printer directly to devices without a wireless router.

**Note:**

*For iOS or Android users, it is convenient to set up from Epson Smart Panel.*

*You only need to make these settings for the printer and the device that you want to connect to once. Unless you disable Wi-Fi Direct or restore the network settings to their defaults, you do not need to make these settings again.*

1. Tap  on the home screen.
2. Tap **Wi-Fi Direct**.
3. Tap **Start Setup**.
4. Select **Other Methods**.
5. Select **Other OS Devices**.

- On the device's Wi-Fi screen, select the SSID shown on the printer's control panel, and then enter the password.

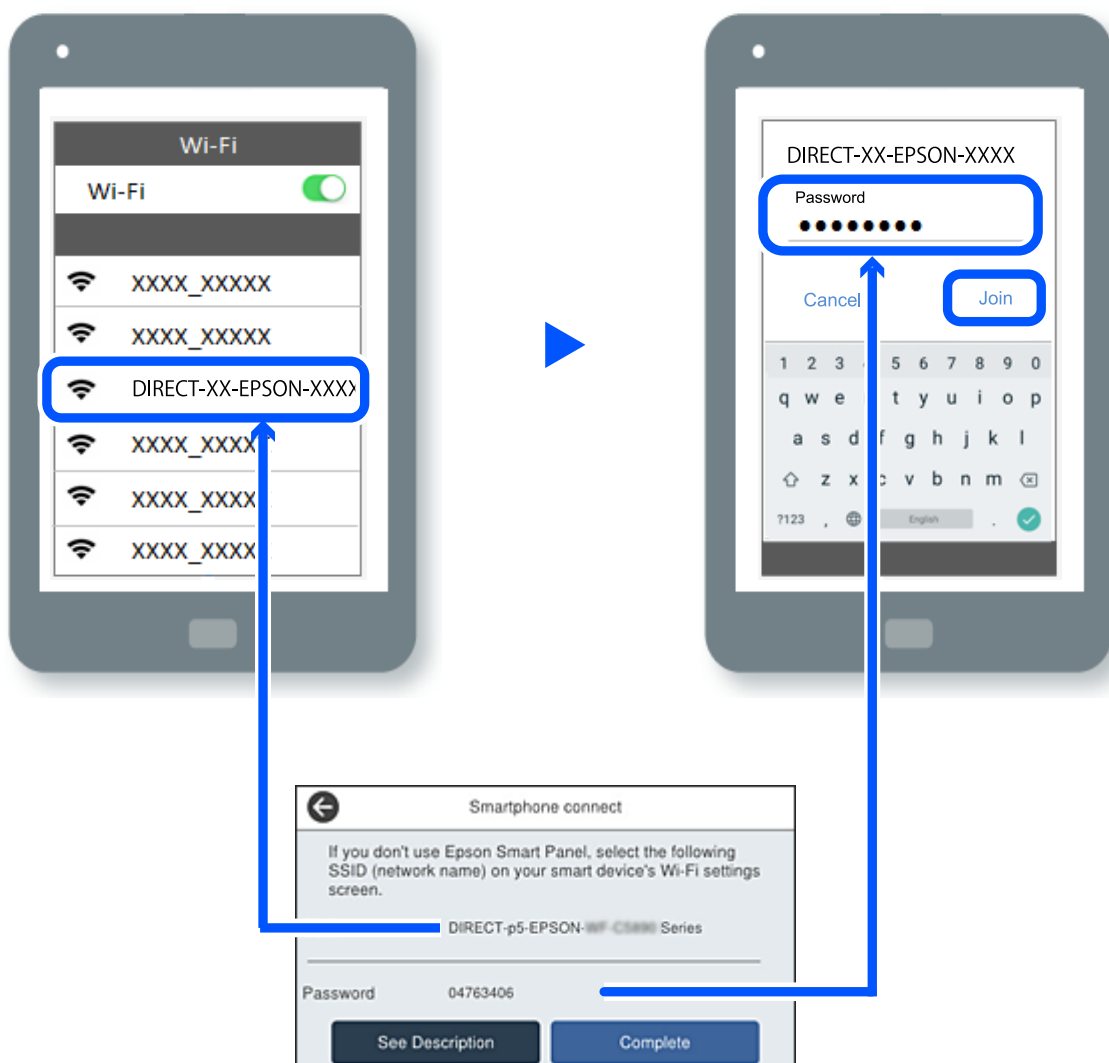

- On the printing app screen for the device, select the printer that you want to connect to.
- On the printer's control panel, select **Complete**.

For devices that have been connected to the printer before, select the network name (SSID) on the device's Wi-Fi screen to connect them again.



**Note:**

If you are using an iOS device, you can also connect by scanning the QR code with the standard iOS camera. See the link below <https://epson.sn>.



## Disconnecting Wi-Fi Direct (Simple AP) Connection

**Note:**

When Wi-Fi Direct (Simple AP) connection is disabled, all computers and smart devices connected to the printer in Wi-Fi Direct (Simple AP) connection are disconnected. If you want to disconnect a specific device, disconnect from the device instead of the printer.

1. Tap  on the printer's home screen.
2. Select **Wi-Fi Direct**.  
The Wi-Fi Direct information is displayed.
3. Tap **Start Setup**.
4. Tap .
5. Select **Disable Wi-Fi Direct**.
6. Tap the **Disable the settings**.
7. Follow the on-screen instructions.

## Changing the Wi-Fi Direct (Simple AP) Settings Such as the SSID

When Wi-Fi Direct (simple AP) connection is enabled, you can change the settings from  > **Wi-Fi Direct** > **Start Setup** > , and then the following menu items are displayed.

### Change Network Name

Change the Wi-Fi Direct (simple AP) network name (SSID) used for connecting to the printer to your arbitrary name. You can set the network name (SSID) in ASCII characters that is displayed on the software keyboard on the control panel. You can enter up to 22 characters.

When changing the network name (SSID), all connected devices are disconnected. Use the new network name (SSID) if you want to re-connect the device.

### Change Password

Change the Wi-Fi Direct (simple AP) password for connecting to the printer to your arbitrary value. You can set the password in ASCII characters that is displayed on the software keyboard on the control panel. You can enter 8 to 22 characters.

When changing the password, all connected devices are disconnected. Use the new password if you want to re-connect the device.

### Change Frequency Range

Change the frequency range of Wi-Fi Direct used for connecting to the printer. You can select 2.4 GHz or 5 GHz.

When changing the frequency range, all connected devices are disconnected. Re-connect the device.

Note that you cannot re-connect from devices that do not support 5 GHz frequency range when changing to 5 GHz.

### Disable Wi-Fi Direct

Disable Wi-Fi Direct (simple AP) settings of the printer. When disabling it, all devices connected to the printer in Wi-Fi Direct (Simple AP) connection are disconnected.

### Restore Default Settings

Restore all Wi-Fi Direct (simple AP) settings to their defaults.

The Wi-Fi Direct (simple AP) connection information of the smart device saved to the printer is deleted.

---

## Changing the Connection from Wi-Fi to USB

Follow the steps below if the Wi-Fi you are using is unstable, or if you want to change to a more stable USB connection.

1. Connect the printer to a computer using a USB cable.
2. Select a printer that is not labeled (XXXXXX) when printing using a USB connection.  
Your printer name or "Network" is displayed in XXXXX depending on the operating system version.

Example of Windows 11

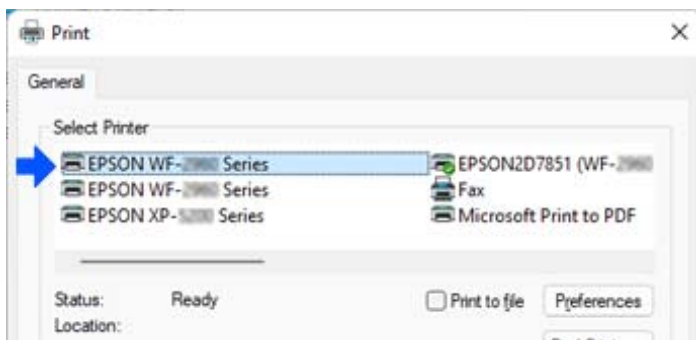

Example of Windows 10

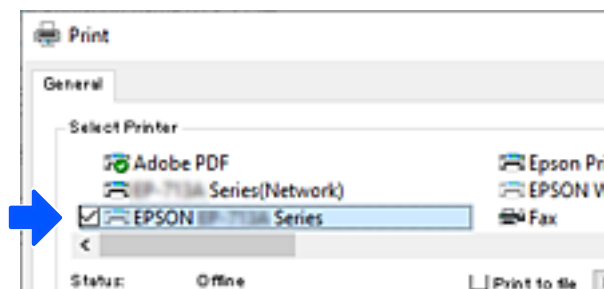

If the printer is not recognized while it is connected to the computer by a USB cable, a printer administrator may have restricted the external interface connection. Contact your administrator.

### Related Information

- ➔ [“Rear” on page 26](#)
- ➔ [“Restricting USB Connections and Use of External Memory” on page 436](#)

## Using a Printer with the Access Control Feature Enabled

When you see  on the printer's control panel, users are restricted by the printer administrator.

In this situation, users cannot make changes to printer settings and cannot use some of the printer's features. You need to log in to the printer to use it.

### Related Information

➔ [“Default Value of the Administrator Password” on page 19](#)

## Logging on to the Printer from the Control Panel

This explanation is an example for logging in to the printer with the administrator lock and access control features enabled and when one or more users are registered. The content displayed on the screens varies depending on the model and situation.

1. Select  on the printer's control panel.

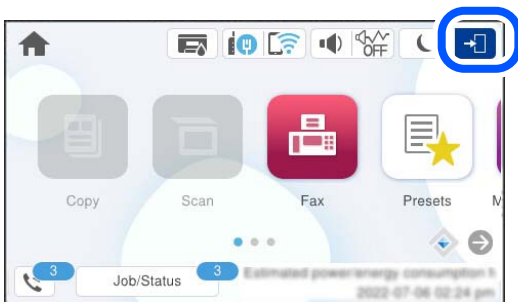

2. Select a user to log in to the printer.

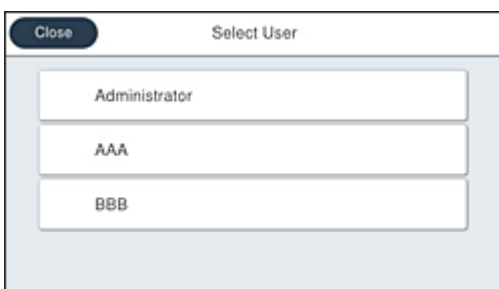

3. Enter a password to log in to the printer.

Contact your printer administrator for login information. The administrator password is set by default. See the related information for details.

Registered users can use the printer with the authorized features. If you log in as an administrator, you can make settings from the control panel.

When you have finished making operations, select  to logout.

### Related Information

➔ [“Default Value of the Administrator Password” on page 19](#)

## Registering a User Account on the Printer Driver (Windows)

When the access control feature is enabled for a printer, you can print from drivers after registering the user account on the drivers to which authentication information can be registered.

This section explains the procedure for registering a user account to a genuine Epson printer driver.

1. Access the Epson printer driver window.
2. Select in the following order.  
**Maintenance** tab > **Printer and Option Information**
3. Select **Save Access Control settings**, and then click **Settings**.
4. Enter **User Name** and **Password**, and then click **OK**.  
Enter the user account provided by your printer administrator.
5. Click **OK** several times to close the printer driver window.

### Related Information

➔ [“Application for Printing from a Computer \(Windows Printer Driver\)” on page 349](#)

➔ [“Creating the User Account” on page 433](#)

## Authenticating Users on Epson Scan 2 when Using Access Control

When the access control function is enabled for a printer, you need to register a user name and password when scanning using Epson Scan 2. If you do not know the password, contact your printer administrator.

1. Start Epson Scan 2.
2. On the Epson Scan 2 screen, make sure that your printer is selected in the **Scanner** list.
3. Select **Settings** from the **Scanner** list to open the **Scanner Settings** screen.
4. Click **Access Control**.
5. On the **Access Control** screen, enter the **User Name** and the **Password** for an account that has permission to scan.
6. Click **OK**.

### Related Information

➔ [“Creating the User Account” on page 433](#)



## Transporting and Storing the Printer

When you need to store the printer or transport it when moving or for repairs, follow the steps below to pack the printer.

 **Caution:**

- When carrying the printer, lift it using a stable position. Lifting the printer using an unstable position may result in injury.
- Because this printer is heavy, it should always be carried by two or more people when unpacking and transporting.
- When lifting the printer, two or more people should assume the correct positions as shown below. Uninstall the optional paper cassette unit if it is installed. If you lift the printer holding other positions, the printer may fall or you may trap your fingers when placing the printer.

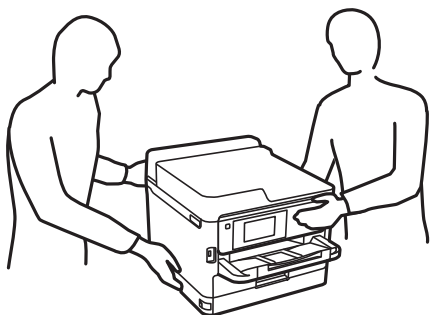

- When carrying the printer, do not tilt it more than 10 degrees; otherwise the printer may fall.
- Be careful not to trap your hand or fingers when opening or closing the scanner unit. Otherwise you may be injured.

 **Important:**

- When storing or transporting the printer, avoid tilting it, placing it vertically, or turning it upside down; otherwise ink may leak.
- Leave the ink supply unit installed. Removing the ink supply unit can dry out the print head and may prevent the printer from printing.

1. Turn off the printer by pressing the  button.
2. Make sure the power light turns off, and then unplug the power cord.

 **Important:**

*Unplug the power cord when the power light is off. Otherwise, the print head does not return to the home position causing the ink to dry, and printing may become impossible.*

3. Disconnect all cables such as the power cord and USB cable.
4. If the printer supports external storage devices, make sure they are not connected.
5. Remove all of the paper from the printer.

6. Make sure there are no originals on the printer.
7. Open the scanner unit with the document cover closed. Secure the print head to the case with tape.

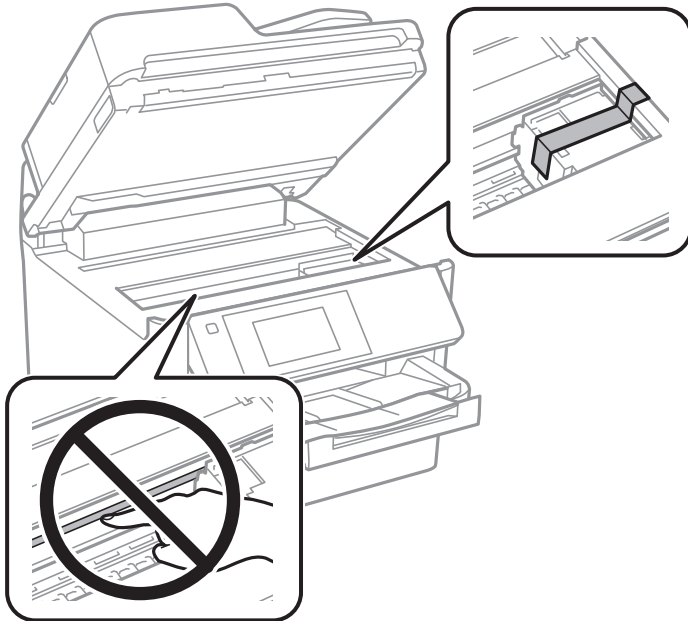

8. Close the scanner unit.
9. Open the ink cover.

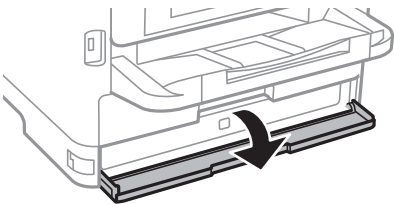

If the ink cover is locked, you cannot open it. Release the cover lock.

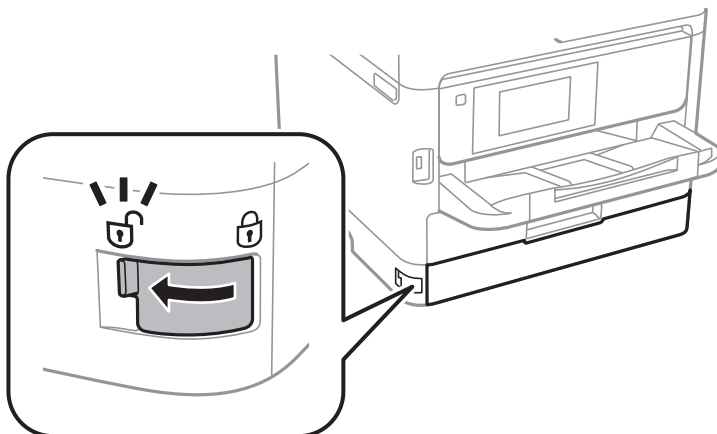

- Secure the ink tray by attaching the supplied protective material with tape so that the tray can not open.

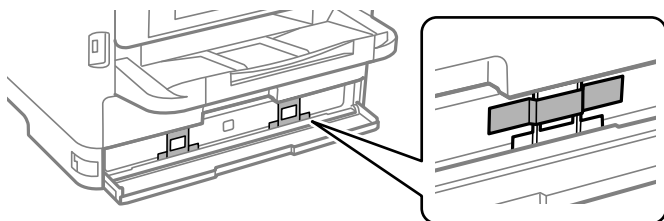

- Close the ink cover.
- Uninstall the optional paper cassette unit if it is installed.

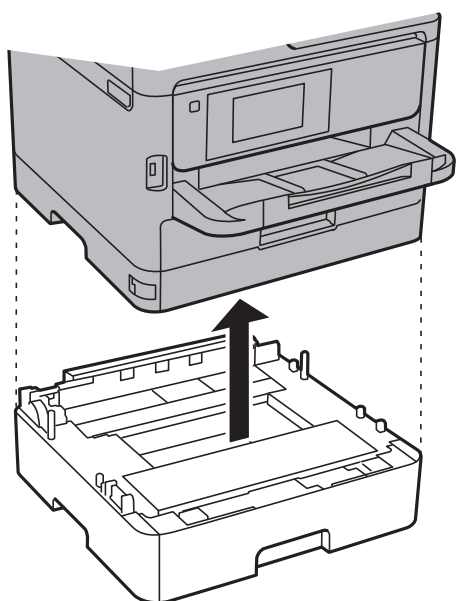

- Prepare to pack the printer as shown below.

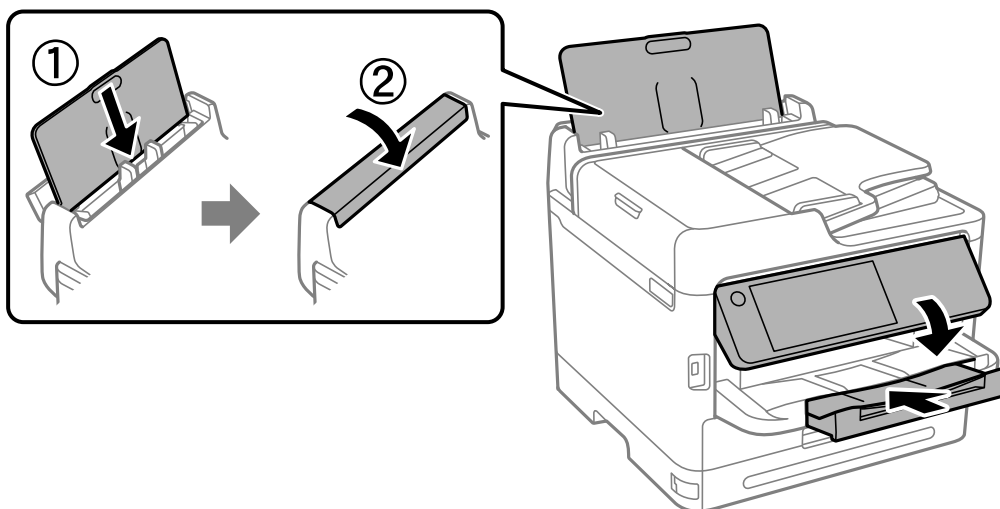

14. Remove the output tray from the printer.

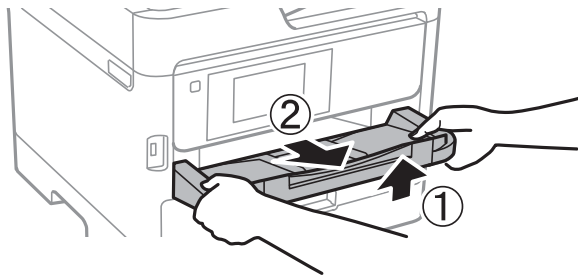

15. Pack the printer in its box, using the protective materials.

When you use the printer again, make sure you remove the tape securing the print head and the protective material attached on the ink tray. If print quality has declined the next time you print, clean and align the print head.

#### **Related Information**

- ➔ [“Checking and Cleaning the Print Head” on page 263](#)
- ➔ [“Aligning the Print Head” on page 264](#)

---

# Solving Problems

Problem Solving. . . . .	290
Cannot Print, Copy, Scan, or Fax. . . . .	292
Printing, Copying, Scanning, and Faxing Quality is Poor. . . . .	305
A Message or Error Code is Displayed on the LCD Screen. . . . .	323
Paper Gets Jammed. . . . .	331
It is Time to Replace Ink Supply Units. . . . .	331
It is Time to Replace the Maintenance Box. . . . .	333
It is Time to Replace the Pickup Rollers. . . . .	334
Cannot Operate the Printer as Expected. . . . .	335
Cannot Solve Problem. . . . .	341

## Problem Solving

If any problems occur, check the following in order to find the cause.

### Check the printer's error status.

Check if there is a problem with the printer itself.



Check Point	Solution
Is there an error on the printer?	If an error message is displayed on the LCD screen, follow the message to solve the problem. If you cannot solve it due to limited access controls, contact the administrator.
	If the paper is jammed, check the LCD screen to see where the paper is jammed, and then follow the instructions to remove it. For precautions, see the applicable descriptions in this manual.
	If a message for replacing consumables is displayed, follow the on-screen instructions to replace them. For handling precautions, see the applicable descriptions in this manual.
Are there any problems with the cables or the printer's appearance?	If the covers are not closed properly, close them. If the cables are about to disconnect, insert them firmly.
Is the power turned off?	If the power is off, press the  button to turn it on.

#### Related Information

- ➔ [“A Message is Displayed on the LCD Screen” on page 323](#)
- ➔ [“Paper Gets Jammed” on page 331](#)
- ➔ [“It is Time to Replace Ink Supply Units” on page 331](#)
- ➔ [“It is Time to Replace the Maintenance Box” on page 333](#)
- ➔ [“It is Time to Replace the Pickup Rollers” on page 334](#)

### Check the printer connection.

Check if there is a problem with the printer connection.

Check point	Solution
Is the printer connected to the network properly?	<p>Run a network connection check to check the network connection.</p> <p>On the LCD screen, select   &gt; <b>How To...</b> &gt; <b>When you cannot connect to the network</b>. Print the network connection report, and then ask the administrator to solve the problem if there is a connection problem.</p>
Is the printer driver installed on your computer?	You can check if the printer driver is installed by checking <b>Settings</b> > <b>Devices</b> > <b>Printers</b> on your computer. See the related information for details.

Check point	Solution
Is the printer's information displayed on your computer?	You can use Epson Status Monitor 3 to check the connection status between the computer and the printer. See the related information for details.
	If you cannot check the printer status, the correct port may not be selected. When you connect to the printer on the network, we recommend that you select <b>EpsonNet Print Port</b> . If <b>EpsonNet Print Port</b> is not available, re-install the printer driver.
Has the wireless LAN (Wi-Fi) connection been interrupted or is it unable to connect when you are using a USB 3.0 device on your computer?	When you connect a device to the USB 3.0 port on a Mac, radio frequency interference may occur. Try the following. <ul style="list-style-type: none"> <li><input type="checkbox"/> Place the device that is connected to the USB 3.0 port further away from the computer.</li> <li><input type="checkbox"/> Turn off any unused USB 3.0 devices or connect them only when necessary.</li> <li><input type="checkbox"/> Connect to the SSID for the 5 GHz range.</li> </ul>
Can your computer or smart device be connected to the network?	Check if you can view the website on your computer or smart device (data communication turned off). If you cannot view it, there is a problem with the network. Ask the administrator to solve the problem.

### Related Information

- ➔ [“Checking the Printer's Network Connection Status \(Network Connection Report\)” on page 278](#)
- ➔ [“There is a problem with the printer's status.” on page 293](#)
- ➔ [“The printer port is not set correctly.” on page 294](#)
- ➔ [“The Printer Cannot Connect by USB” on page 295](#)
- ➔ [“Installing the Applications Separately” on page 272](#)

## Check the printer settings.

Check the printer settings. Printers managed by the administrator may be restricted so that the printer settings cannot be changed. If you cannot perform operations, contact the administrator.

Check point	Solution
Printing does not start.	There may still be data remaining in the printer. Open the printer queue, and then check the status of the print job. If it is pending with an error, clear the error and restart it or delete the job with the error, and then the rest of the data will start printing.
	If the default printer is pending or offline, set it to online in the printer settings on the Windows computer.
	Select the printer and port to output correctly.
The menu that you want to use is not displayed.	Access control has been set by your administrator. Contact the administrator for the information required to use the missing menu.
	Some features require a separate contract to use. Contact your administrator to check if the feature is available for your printer.

Check point	Solution
Cannot fax.	If you have any problems when faxing, see the solutions to fax related problems.
Cannot copy or scan.	If you have any problems when copying or scanning, see the solutions to copy or scan related problems.

### Related Information

- ➔ “There is still a job waiting to be printed.” on page 293
- ➔ “The printer is pending or offline.” on page 292
- ➔ “Using Port for the Printer” on page 395
- ➔ “Cannot Copy” on page 296
- ➔ “Cannot Scan Even Though a Connection has been Correctly Established” on page 295
- ➔ “Cannot Send or Receive Faxes” on page 296

## Cannot Print, Copy, Scan, or Fax

### The Application or Printer Driver do not Work Properly

#### Cannot Print Even Though a Connection has been Established (Windows)

The following causes can be considered.

##### ■ The printer is pending or offline.

###### Solutions

Click **Print Queue** on the printer driver's **Maintenance** tab.

If the printer is offline or pending, clear the offline or pending setting from the **Printer** menu.

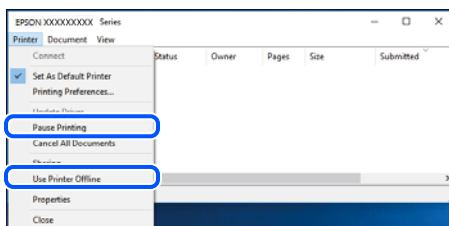

##### ■ There is a problem with the software or data.

###### Solutions

- ❑ Make sure that a genuine Epson printer driver (EPSON XXXXX) is installed. If a genuine Epson printer driver is not installed, the available functions are limited. We recommend using a genuine Epson printer driver.
- ❑ If you are printing a large data size image, the computer may run out of memory. Print the image at a lower resolution or a smaller size.



- ❑ If you have tried all of the solutions and have not solved the problem, try uninstalling and then reinstalling the printer driver.
- ❑ You may be able to clear the problem by updating the software to the latest version. To check the software status, use the software update tool.
- ➔ “Checking if a genuine Epson printer driver is installed - Windows” on page 273
- ➔ “Checking if a genuine Epson printer driver is installed - Mac OS” on page 275
- ➔ “Installing or Uninstalling Applications Separately” on page 272

### There is a problem with the printer's status.

#### Solutions

Click **EPSON Status Monitor 3** on the printer driver's **Maintenance** tab, and then check the printer status. If **EPSON Status Monitor 3** is disabled, click **Extended Settings** on the **Maintenance** tab, and then select **Enable EPSON Status Monitor 3**.

### There is still a job waiting to be printed.

#### Solutions

Click **Print Queue** on the printer driver's **Maintenance** tab. If unnecessary data remains, select **Cancel all documents** from the **Printer** menu.

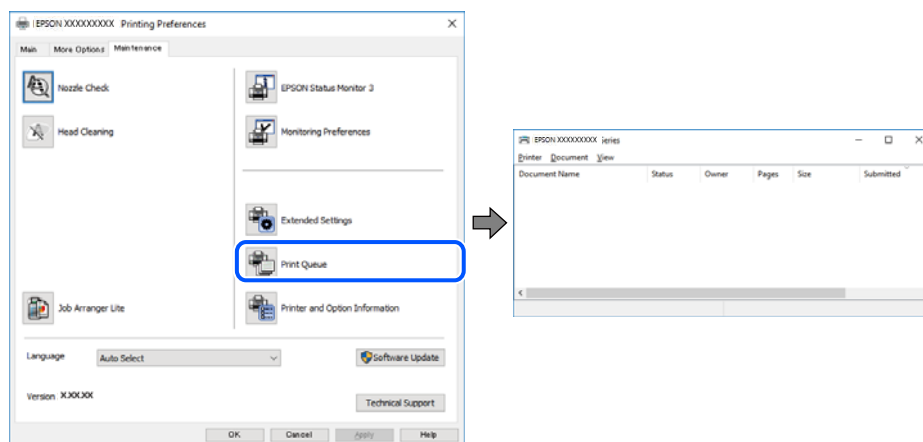

### The printer is not selected as the default printer.

#### Solutions

Right-click the printer icon in **Control Panel** > **View devices and printers** (or **Printers, Printers and Faxes**) and click **Set as default printer**.

#### Note:

*If there are multiple printer icons, see the following to select the correct printer.*

Example)

USB connection: EPSON XXXX Series

Network connection: EPSON XXXX Series (network)

If you install the printer driver multiple times, copies of the printer driver may be created. If copies such as "EPSON XXXX Series (copy 1)" are created, right-click the copied driver icon, and then click **Remove Device**.

### ■ **The printer port is not set correctly.**

#### **Solutions**

Click **Print Queue** on the printer driver's **Maintenance** tab.

Make sure the printer port is set correctly as shown below in **Property > Port** from the **Printer** menu.

USB connection: **USBXXX**, Network connection: **EpsonNet Print Port**

If you cannot change the port, select **Run as administrator** on the **Printer** menu. If **Run as administrator** is not displayed, contact your system administrator.

### **Printer Does Not Print While Using PostScript Printer Driver (Windows)**

The following causes can be considered.

### ■ **The Printing Language setting needs to be changed.**

#### **Solutions**

Set the **Printing Language** setting to **Auto** or **PS** on the control panel.

### ■ **A large number of jobs have been sent.**

#### **Solutions**

In Windows, if a large number of jobs are sent, the printer may not print. Select **Print directly to the printer** on the **Advanced** tab in the printer properties.

### **Cannot Print Even Though a Connection has been Established (Mac OS)**

The following causes can be considered.

### ■ **There is a problem with the software or data.**

#### **Solutions**

- Make sure that a genuine Epson printer driver (EPSON XXXXX) is installed. If a genuine Epson printer driver is not installed, the available functions are limited. We recommend using a genuine Epson printer driver.
- If you are printing a large data size image, the computer may run out of memory. Print the image at a lower resolution or a smaller size.
- If you have tried all of the solutions and have not solved the problem, try uninstalling and then reinstalling the printer driver.
- You may be able to clear the problem by updating the software to the latest version. To check the software status, use the software update tool.

➔ [“Checking if a genuine Epson printer driver is installed - Windows” on page 273](#)

➔ [“Checking if a genuine Epson printer driver is installed - Mac OS” on page 275](#)

➔ [“Installing or Uninstalling Applications Separately” on page 272](#)

### ■ **There is a problem with the status of the printer.**

#### **Solutions**

Make sure the printer status is not **Pause**.

Select **System Preferences** from the **Apple** menu > **Printers & Scanners** (or **Print & Scan, Print & Fax**), and then double-click the printer. If the printer is paused, click **Resume**.

■ **User feature restrictions are enabled for the printer.**

**Solutions**

The printer may not print when the user feature restriction is enabled. Contact your printer administrator.

**Printer Does Not Print While Using PostScript Printer Driver (Mac OS)**

■ **The Printing Language setting needs to be changed.**

**Solutions**

Set the **Printing Language** setting to **Auto** or **PS** on the control panel.

**Cannot Print Even Though a Connection has been Established (iOS)**

The following causes can be considered.

■ **Paper Setup Auto Display is disabled.**

**Solutions**

Enable **Paper Setup Auto Display** in the following menu.

**Settings > General Settings > Printer Settings > Paper Source Settings > Paper Setup Auto Display**

■ **AirPrint is disabled.**

**Solutions**

Enable the **AirPrint** setting on **Web Config**.

➔ [“Application for Configuring Printer Operations \(Web Config\)” on page 355](#)

**Cannot Scan Even Though a Connection has been Correctly Established**

■ **Scanning at a high resolution over a network.**

**Solutions**

Try scanning at a lower resolution.

**The Printer Cannot Connect by USB**

The following causes can be considered.

■ **The USB cable is not plugged into the USB inlet correctly.**

**Solutions**

Connect the USB cable securely to the printer and the computer.

■ **There is a problem with the USB hub.**

**Solutions**

If you are using a USB hub, try to connect the printer directly to the computer.

■ **There is a problem with the USB cable or the USB inlet.**

**Solutions**

If the USB cable cannot be recognized, change the port, or change the USB cable.

■ **The printer is connected to a SuperSpeed USB port.**

**Solutions**

If you connect the printer to a SuperSpeed USB port using a USB 2.0 cable, a communication error may occur on some computers. In this case, re-connect the printer using one of the following methods.

- Use a USB 3.0 cable (Supported models only).
- Connect to a Hi-Speed USB port on the computer.
- Connect to a SuperSpeed USB port other than the port that generated the communication error.

➔ [“Interface Specifications” on page 397](#)

## Cannot Copy

■ **When the user feature restriction is enabled, a user ID and password are required to copy.**

**Solutions**

If you do not know the password, contact your printer administrator.

■ **The printer error has occurred.**

**Solutions**

You cannot copy if an error, such as a paper jam, has occurred in the printer. Check the printer's control panel and follow the on-screen instructions to clear the error.

## Cannot Send or Receive Faxes

### Cannot Send or Receive Faxes

If you cannot send or receive faxes, contact your printer administrator. For printer administrators, see the following section to troubleshoot fax problems.

[“Cannot Send or Receive Faxes” on page 133](#)

### Cannot Send Faxes

The following causes can be considered.

**Sending faxes without entering an access code in an environment in which a PBX is installed.**

**Solutions**

If your phone system requires an external access code to get an outside line, register the access code to the printer, and enter # (hash) at the beginning of a fax number when sending.

**The recipient's fax number is wrong.**

**Solutions**

Check that the recipient's number registered in your contacts list or that you entered directly using the keypad is correct. Or, check with the recipient that the fax number is correct.

**The data being sent is too large.**

**Solutions**

You can send faxes at a smaller data size using one of the following methods.

- When you send the fax in monochrome, enable **Direct Send** in **Fax > Fax Settings > Fax Send Settings**.  
[“Sending Many Pages of a Monochrome Document \(Direct Send\)” on page 230](#)
- Using the connected phone  
[“Sending Faxes Dialing from the External Phone Device” on page 228](#)
- Using On Hook  
[“Sending Faxes Manually After Confirming the Recipient's Status” on page 227](#)
- Separating the originals

**The available memory in the printer is not enough.**

**Solutions**

You cannot send faxes when the printer's memory is insufficient because of a lot of received documents in inbox or confidential boxes or many unprocessed fax documents stored in the printer. Delete the unnecessary documents in inbox or confidential boxes or process the unprocessed documents to increase available memory.

**The recipient's fax machine is not ready to receive faxes.**

**Solutions**

Ask the recipient if the recipient's fax machine is ready to receive a fax.

**Sending a fax accidentally using the subaddress feature.**

**Solutions**

Check if you accidentally sent a fax using the subaddress feature. If you select a recipient with a subaddress from the contact list, the fax may be sent using the subaddress feature.

**The recipient's fax machine is not capable of receiving faxes using the subaddress feature.**

**Solutions**

When sending faxes using the subaddress feature, ask the recipient if their fax machine is capable of receiving faxes using the subaddress feature.

■ **The subaddress and password are wrong.**

**Solutions**

When sending faxes using the subaddress feature, check that the subaddress and password are correct. Check with the recipient that the subaddress and password match.

■ **Cannot Send Faxes After Trying the Solutions Above**

**Solutions**

If you cannot solve the problem, contact your printer administrator. For printer administrators, see the following section to troubleshoot fax problems.

[“Cannot Send Faxes” on page 134](#)

## **Cannot Receive Faxes**

The following causes can be considered.

We also recommend checking the printer status in **Job/Status**, such as whether or not the printer is currently receiving the fax.

■ **The available memory of the inbox and the confidential box is not enough.**

**Solutions**

200 received documents have been saved in the inbox and the confidential box in total. Delete the unnecessary documents.

■ **The sender's fax number has not been registered in the contacts list.**

**Solutions**

Faxes sent from numbers that have not been registered to the contacts list are set to be blocked. Register the sender's fax number to contact list.

■ **The sender has sent the fax without header information.**

**Solutions**

Faxes that do not include header information are set to be blocked. Ask the sender if header information is setup on their fax machine.

■ **The computer that will save the received faxes is not turned on.**

**Solutions**

When you have made settings to save received faxes to a computer, turn on the computer. The received fax is deleted once it has been saved to the computer.

■ **The subaddress and password are wrong.**

**Solutions**

When receiving faxes using the subaddress feature, check that the subaddress and password are correct. Check with the sender that the subaddress and password match.

## ■ Cannot Receive Faxes After Trying the Solutions Above

### Solutions

If you cannot solve the problem, contact your printer administrator. For printer administrators, see the following section to troubleshoot fax problems.



[“Cannot Receive Faxes” on page 134](#)

## Cannot Send Faxes to a Specific Recipient

The following causes can be considered.

### ■ The recipient's machine takes a long time to answer.

#### Solutions

If the recipient machine does not pick up your call within 50 seconds after the printer has finished dialing, the call ends with an error. Dial using the  (**On Hook**) feature or using a connected telephone to check how long it takes before you hear a fax tone. If it takes more than 50 seconds, add pauses after the fax number to send the fax. Tap  to enter the pause. A hyphen is entered as the pause mark. One pause is about three seconds. Add multiple pauses as needed.

### ■ The Fax Speed setting registered in the contact list is wrong.

#### Solutions

Select the recipient from the contact list, and then select **Edit** > **Fax Speed** > **Slow(9,600bps)**.

## Cannot Send Faxes at a Specified Time

The date and time set on the printer may be incorrect. Contact your printer administrator. For printer administrators, see the following section to troubleshoot fax problems.

[“Cannot Send Faxes at a Specified Time” on page 135](#)

## Faxes Are Sent at the Wrong Size

The following causes can be considered.

### ■ The originals are not placed correctly.

#### Solutions

- Make sure the original is placed correctly against the alignment marks.
- If the edge of the scanned image is missing, move the original slightly away from the edge of the scanner glass. You cannot scan the area within approximately 1.5 mm (0.06 in.) from the edge of the scanner glass.

➔ [“Placing Originals” on page 145](#)

■ **There is dust or dirt on the scanner glass.**

**Solutions**

When scanning from the control panel and selecting auto scan area cropping function, remove any trash or dirt from the scanner glass and document cover. If there is any trash or dirt around the original, the scanning range expands to include it.

[“Cleaning the Scanner Glass” on page 265](#)

**Cannot Save Received Faxes to a Memory Device**

The following causes can be considered.

■ **A memory device is not connected to the printer.**

**Solutions**

Connect a memory device, in which you have created a folder to save faxes, to the printer. Once the faxes are saved in the device, they are deleted from the printer's memory.

■ **There is not enough free space in the device.**

**Solutions**

Delete unnecessary data from the device to increase the amount of free space. Or, connect another device that has enough free space.

■ **The memory device is write-protected.**

**Solutions**

Disable write protection on the memory device.

■ **Saving received faxes to external memory is disabled.**

**Solutions**

Contact your printer administrator. For printer administrators, see the following section to troubleshoot fax problems.

[“Cannot Save Received Faxes to a Memory Device” on page 136](#)

**Received Faxes Are Not Printed**

The following causes can be considered.

■ **An error has occurred in the printer such as a paper jam.**

**Solutions**

Clear the printer error, and then ask the sender to resend the fax.

■ **Cannot Print Faxes After Trying the Solutions Above**

**Solutions**

If you cannot solve the problem, contact your printer administrator. For printer administrators, see the following section to troubleshoot fax problems.

[“Received Faxes Are Not Printed” on page 136](#)



## **Cannot Send or Receive Faxes Even Though a Connection has been Correctly Established (Windows)**

The following causes can be considered.

### **■ The software is not installed.**

#### **Solutions**

Make sure that the PC-FAX driver have been installed on the computer. The PC-FAX driver is installed with FAX Utility. Follow the steps below to check if it is installed.

Make sure the printer (fax) is displayed in **Devices and Printers, Printer, or Printers and Other Hardware**. The printer (fax) is displayed as "EPSON XXXXX (FAX)". If the printer (fax) is not displayed, uninstall and then re-install the FAX Utility. See the following to access **Devices and Printers, Printer, or Printers and Other Hardware**.

#### Windows 11

Click on the start button, and then select **All Apps > Windows Tools > Control Panel > View devices and printers in Hardware and Sound**.

#### Windows 10

Click on the start button, and then select **Windows System > Control Panel > View devices and printers in Hardware and Sound**.

#### Windows 8.1/Windows 8

Select **Desktop > Settings > Control Panel > View devices and printers in Hardware and Sound or Hardware**.

#### Windows 7

Click the start button, and select **Control Panel > View devices and printers in Hardware and Sound or Hardware**.

#### Windows Vista

Click the start button, and select **Control Panel > Printers in Hardware and Sound**.

#### Windows XP

Click the start button, and select **Settings > Control Panel > Printers and Other Hardware > Printers and Faxes**.

### **■ User authentication failed when a fax is sent from a computer.**

#### **Solutions**

Set the user name and password in the printer driver. When sending a fax from a computer when the security function that restrict users from using the printer's fax function is set, user authentication is performed with the user name and password set in the printer driver.

### **■ There are some problems with fax connection and fax settings.**

#### **Solutions**

Try the resolutions for fax connection and fax settings.

## **Cannot Send or Receive Even Though a Connection has been Correctly Established (Mac OS)**

The following causes can be considered.

### ■ **The software is not installed.**

#### **Solutions**

Make sure that the PC-FAX driver have been installed on the computer. The PC-FAX driver is installed with FAX Utility. Follow the steps below to check if it is installed.

Select **System Preferences** from the Apple menu > **Printers & Scanners** (or **Print & Scan, Print & Fax**), and then make sure the printer (fax) is displayed. The printer (fax) is displayed as "FAX XXXX (USB)" or "FAX XXXX (IP)". If the printer (fax) is not displayed, click [+] and then register the printer (fax).

### ■ **PC-FAX driver is paused.**

#### **Solutions**

Select **System Preferences** from the Apple menu > **Printers & Scanners** (or **Print & Scan, Print & Fax**), and then double-click the printer (fax). If the printer is paused, click **Resume** (or **Resume Printer**).

### ■ **User authentication failed when a fax is sent from a computer.**

#### **Solutions**

Set the user name and password in the printer driver. When sending a fax from a computer when the security function that restrict users from using the printer's fax function is set, user authentication is performed with the user name and password set in the printer driver.

### ■ **There are some problems with fax connection and fax settings.**

#### **Solutions**

Try the resolutions for fax connection and fax settings.

## **Paper Does Not Feed or Eject Correctly**

### **Points to Check**

Check the following items, and then try the solutions according to the problems.

### ■ **The installation location is inappropriate.**

#### **Solutions**

Place the printer on a flat surface and operate in the recommended environmental conditions.

➔ [“Environmental Specifications” on page 403](#)

### ■ **Unsupported paper is being used.**

#### **Solutions**

Use paper supported by this printer.

➔ [“Available Paper and Capacities” on page 344](#)

➔ [“Unavailable Paper Types” on page 347](#)

■ **Paper handling is inappropriate.**

**Solutions**

Follow paper handling precautions.

➔ [“Paper Handling Precautions” on page 140](#)

■ **Too many sheets are loaded in the printer.**

**Solutions**

Do not load more than the maximum number of sheets specified for the paper. For plain paper, do not load above the line indicated by the triangle symbol on the edge guide.

➔ [“Available Paper and Capacities” on page 344](#)

■ **The paper settings on the printer are incorrect.**

**Solutions**

Make sure the paper size and paper type settings match the actual paper size and paper type loaded in the printer.

➔ [“Paper Size and Type Settings” on page 140](#)

## **Paper Feeds at a Slant**

The following causes can be considered.

■ **The paper is loaded incorrectly.**

**Solutions**

Load paper in the correct direction, and slide the edge guide against the edge of the paper.

➔ [“Loading Paper” on page 142](#)

## **Several Sheets of Paper are Fed at a Time**

The following causes can be considered.

■ **The paper is moist or damp.**

**Solutions**

Load new paper.

■ **Static electricity is causing sheets of paper to stick to each other.**

**Solutions**

Fan the paper before loading. If the paper still does not feed, load one sheet of paper at a time.

## Paper Out Error Occurs

### ■ Paper is not loaded in the center of the paper tray.

#### Solutions

When a paper out error occurs although paper is loaded in the paper tray, reload paper in the center of the paper tray.

## Original Does Not Feed in the ADF

The following causes can be considered.

### ■ Originals that are not supported by the ADF are being used.

#### Solutions

Use originals supported by the ADF.

➔ [“ADF Specifications” on page 394](#)

### ■ The originals are loaded incorrectly.

#### Solutions

Load originals in the correct direction, and slide the ADF edge guides against the edges of the originals.

### ■ Too many originals are loaded in the ADF.

#### Solutions

Do not load originals above the line indicated by the triangle symbol on the ADF.

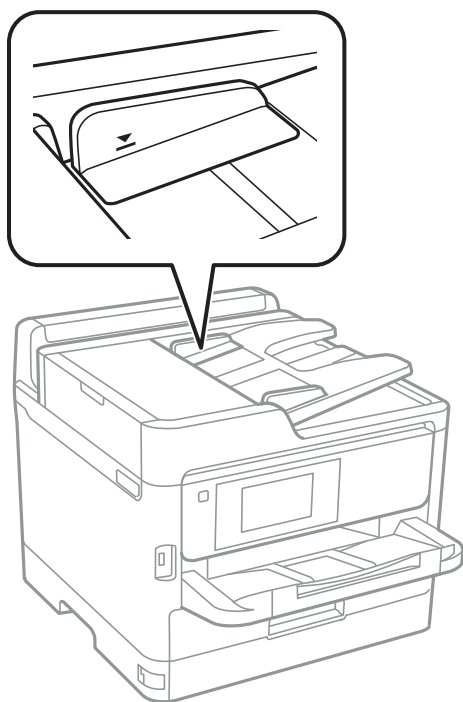

■ **The original slips when paper dust adheres to the roller.**

**Solutions**

Clean the inside of the ADF.

➔ [“Cleaning the ADF” on page 265](#)

■ **Originals are not detected.**

**Solutions**

On the screen for copy or scan, or fax, check that the ADF icon is on. If it is off, place the originals again.

## **Paper Does Not Feed from the Paper Cassette Units**

■ **Settings for optional items have not been made in the printer driver.**

**Solutions**

You need to make settings in the printer driver.

➔ [“Setting Available Optional Items” on page 63](#)

---

# **Printing, Copying, Scanning, and Faxing Quality is Poor**

## **Print Quality is Poor**

### **Banding Appears in Printouts**



■ **The print head nozzles may be clogged.**

**Solutions**

Use the **Print Quality Adjustment** feature. If you have not used the printer for a long time, the print head nozzles may be clogged and ink drops may not be discharged.

➔ [“Adjusting the Print Quality” on page 262](#)

## Black or Gray Banding Appears at Intervals of Approximately 3.3 cm



The following causes can be considered.

### ■ The paper type setting does not match the paper loaded.

#### Solutions

Select the appropriate paper type setting for the type of paper loaded in the printer.

➔ [“List of Paper Type” on page 141](#)

### ■ The print quality is set to low.

#### Solutions

When printing on plain paper, print using a higher quality setting.

#### Control panel

In the print settings, select the **Advanced** tab if there is an **Advanced** tab, and then select **Best** as the **Quality**.

#### Windows

Select **High** from **Quality** on the printer driver's **Main** tab.

#### Mac OS

Select **Fine** as **Print Quality** from the print dialog's **Print Settings** menu.

### ■ The print head position is out of alignment.

#### Solutions

Align the print head using the **Print Quality Adjustment** feature.

➔ [“Adjusting the Print Quality” on page 262](#)

## Vertical Banding or Misalignment

enthalten alle  
Aufdruck. W  
5008 "Regel

The following causes can be considered. Check the causes and follow the solutions in order from the top.

## ■ The print head position is out of alignment.

### Solutions

Align the print head using the **Print Quality Adjustment** feature.

➔ [“Adjusting the Print Quality” on page 262](#)

## ■ The bidirectional printing setting is enabled.

### Solutions

If print quality does not improve even after aligning the print head, disable the bidirectional setting.

During bidirectional (or high speed) printing, the print head prints while moving in both directions, and vertical lines may be misaligned. Disabling this setting may slow down printing speed but improve print quality.

#### Control panel

Select **Settings** > **General Settings** > **Printer Settings**, and then disable **Bidirectional**.

#### Windows

Clear **Bidirectional Printing** on the printer driver's **More Options** tab.

#### Mac OS

Select **System Preferences** from the Apple menu > **Printers & Scanners** (or **Print & Scan**, **Print & Fax**), and then select the printer. Click **Options & Supplies** > **Options** (or **Driver**). Select **Off** as the **Bidirectional Printing** setting.

## Printout Comes Out as a Blank Sheet

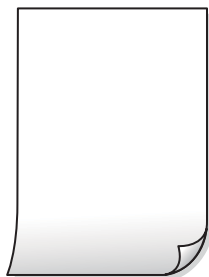

## ■ The print head nozzles may be clogged.

### Solutions

Use the **Print Quality Adjustment** feature. If you have not used the printer for a long time, the print head nozzles may be clogged and ink drops may not be discharged.

➔ [“Adjusting the Print Quality” on page 262](#)

## ■ The print settings and the paper size loaded in the printer are different.

### Solutions

Change the print settings according to the paper size loaded in the printer. Load paper in the printer that matches the print settings.

■ **Multiple sheets of paper are fed into the printer at the same time.**

**Solutions**

See the following to prevent multiple sheets of paper being fed into the printer at the same time.

➔ [“Several Sheets of Paper are Fed at a Time” on page 303](#)

**Paper Is Smearred or Scuffed**



The following causes can be considered.

■ **Paper is loaded incorrectly.**

**Solutions**

When horizontal banding (perpendicular to the printing direction) appears, or the top or bottom of the paper is smeared, load paper in the correct direction and slide the edge guides to the edges of the paper.

■ **The paper path is smeared.**

**Solutions**

When vertical banding (horizontal to the printing direction) appears, or the paper is smeared, clean the paper path.

➔ [“Cleaning the Paper Path for Ink Smears” on page 264](#)

■ **The paper is curled.**

**Solutions**

Place the paper on a flat surface to check if it is curled. If it is, flatten it.

■ **The print head is rubbing the surface of the paper.**

**Solutions**

When printing on thick paper, the print head is close to the printing surface and the paper may be scuffed. In this case, enable the reduce scuff setting. If you enable this setting, print quality may decline or printing may slow down.

Control panel

Select **Settings** > **General Settings** > **Printer Settings**, and then enable **Thick Paper**.

Windows

Click **Extended Settings** on the printer driver's **Maintenance** tab, and then select **Thick Paper and Envelopes**.



❑ Mac OS

Select **System Preferences** from the Apple menu > **Printers & Scanners** (or **Print & Scan**, **Print & Fax**), and then select the printer. Click **Options & Supplies** > **Options** (or **Driver**). Select **On** as the **Thick paper and envelopes** setting.

■ **The back of the paper was printed before the side that had already been printed was dry.**

**Solutions**

When performing manual 2-sided printing, make sure that the ink is completely dry before reloading the paper.

■ **When printing using automatic 2-sided printing, the print density is too high and the drying time is too short.**

**Solutions**

When using the automatic 2-sided printing feature and printing high density data such as images and graphs, set the print density to lower and the drying time to longer.

➔ [“Printing on 2-Sides” on page 158](#)

## The Position, Size, or Margins of the Printout Are Incorrect



The following causes can be considered.

■ **The paper is loaded incorrectly.**

**Solutions**

Load paper in the correct direction, and slide the edge guide against the edge of the paper.

➔ [“Loading Paper” on page 142](#)

■ **The size of the paper is set incorrectly.**

**Solutions**

Select the appropriate paper size setting.

■ **The margin setting in the application software is not within the print area.**

**Solutions**

Adjust the margin setting in the application so that it falls within the printable area.



- Mac OS

Clear **Mirror Image** from the print dialog's **Print Settings** menu.

## Mosaic-Like Patterns in the Prints



### ■ Images or photos with a low resolution were printed.

#### Solutions

When printing images or photos, print using high-resolution data. Images on web sites are often low resolution although they look good enough on the display, and so print quality may decline.

## Printer Does Not Print Correctly While Using PostScript Printer Driver

The following causes can be considered.

### ■ There is a problem with the data.

#### Solutions

- If the file is created in an application that allows you to change the data format, such as Adobe Photoshop, make sure that the settings in the application match the settings in the printer driver.
- EPS files made in binary format may not be printed correctly. Set the format to ASCII when making EPS files in an application.
- For Windows, the printer cannot print binary data when it is connected to the computer using a USB interface. Set the **Output Protocol** setting on the **Device Settings** tab in the printer properties to **ASCII** or **TBCP**.
- For Windows, select the appropriate substitution fonts on the **Device Settings** tab in the printer properties.

## Print Quality Is Poor While Using PostScript Printer Driver

### ■ Color settings have not been made.

#### Solutions

You cannot make color settings on the **Paper/Quality** tab in the printer driver. Click **Advanced**, and then set the **Color Mode** setting.

## Copy Quality is Poor

### Banding Appears in Copies



#### ■ The print head nozzles may be clogged.

##### Solutions

Use the **Print Quality Adjustment** feature. If you have not used the printer for a long time, the print head nozzles may be clogged and ink drops may not be discharged.

➔ [“Adjusting the Print Quality” on page 262](#)

### Black or Gray Banding Appears at Intervals of Approximately 3.3 cm



The following causes can be considered.

#### ■ The paper type setting does not match the paper loaded.

##### Solutions

Select the appropriate paper type setting for the type of paper loaded in the printer.

➔ [“List of Paper Type” on page 141](#)

#### ■ The print head position is out of alignment.

##### Solutions

Align the print head using the **Print Quality Adjustment** feature.

➔ [“Adjusting the Print Quality” on page 262](#)

## Vertical Banding or Misalignment

enthalten alle  
Aufdruck. W  
5008 "Regel

The following causes can be considered.

### ■ The print head position is out of alignment.

#### Solutions

Align the print head using the **Print Quality Adjustment** feature.

➔ [“Adjusting the Print Quality” on page 262](#)

### ■ The bidirectional printing setting is enabled.

#### Solutions

If print quality does not improve even after aligning the print head, disable the bidirectional setting.

During bidirectional (or high speed) printing, the print head prints while moving in both directions, and vertical lines may be misaligned. Disabling this setting may slow down printing speed but improve print quality.

Select **Settings > General Settings > Printer Settings**, and then disable **Bidirectional** on the control panel.

## Printout Comes Out as a Blank Sheet

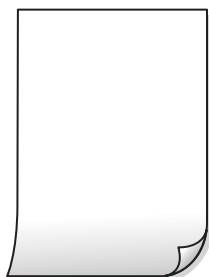

### ■ The print head nozzles may be clogged.

#### Solutions

Use the **Print Quality Adjustment** feature. If you have not used the printer for a long time, the print head nozzles may be clogged and ink drops may not be discharged.

➔ [“Adjusting the Print Quality” on page 262](#)

■ **The print settings and the paper size loaded in the printer are different.**

**Solutions**

Change the print settings according to the paper size loaded in the printer. Load paper in the printer that matches the print settings.

■ **Multiple sheets of paper are fed into the printer at the same time.**

**Solutions**

See the following to prevent multiple sheets of paper being fed into the printer at the same time.

➔ [“Several Sheets of Paper are Fed at a Time” on page 303](#)

## **Paper Is Smearred or Scuffed**



The following causes can be considered.

■ **Paper is loaded incorrectly.**

**Solutions**

When horizontal banding (perpendicular to the printing direction) appears, or the top or bottom of the paper is smeared, load paper in the correct direction and slide the edge guides to the edges of the paper.

■ **The paper path is smeared.**

**Solutions**

When vertical banding (horizontal to the printing direction) appears, or the paper is smeared, clean the paper path.

➔ [“Cleaning the Paper Path for Ink Smears” on page 264](#)

■ **The paper is curled.**

**Solutions**

Place the paper on a flat surface to check if it is curled. If it is, flatten it.

■ **The printhead is rubbing the surface of the paper.**

**Solutions**

When copying on thick paper, the print head is close to the printing surface and the paper may be scuffed. In this case, enable the reduce scuff setting.

Select **Settings > General Settings > Printer Settings**, and then enable **Thick Paper** on the control panel. If you enable this setting, copy quality may decline or may slow down.

## The Position, Size, or Margins of the Copies are Incorrect



The following causes can be considered.

### ■ The paper is loaded incorrectly.

#### Solutions

Load paper in the correct direction, and slide the edge guide against the edge of the paper.

➔ [“Loading Paper” on page 142](#)

### ■ The originals are not placed correctly.

#### Solutions

- Make sure the original is placed correctly against the alignment marks.
- If the edge of the scanned image is missing, move the original slightly away from the edge of the scanner glass. You cannot scan the area within approximately 1.5 mm (0.06 in.) from the edge of the scanner glass.

➔ [“Placing Originals” on page 145](#)

### ■ There is dust or dirt on the scanner glass.

#### Solutions

When placing the originals on the scanner glass, remove any dust or dirt that has stuck to the originals, and clean the scanner glass. If there is dust or stains on the glass, the copy area may extend to include the dust or stains, resulting in the wrong copying position or small images.

➔ [“Cleaning the Scanner Glass” on page 265](#)

### ■ The size of the paper is set incorrectly.

#### Solutions

Select the appropriate paper size setting.

### ■ Original Size is wrong in copy setting.

#### Solutions

Select the appropriate **Original Size** in the copy setting.

## Smears, Dots, or Straight Lines Appear in the Copied Image



The following causes can be considered.

### ■ **The paper path is dirty.**

#### **Solutions**

Load and eject paper without printing to clean the paper path.

➔ [“Cleaning the Paper Path for Ink Smears” on page 264](#)

### ■ **There is dust or dirt on the originals or the scanner glass.**

#### **Solutions**

Remove any dust or dirt that adheres to the originals, and clean the scanner glass.

➔ [“Cleaning the Scanner Glass” on page 265](#)

### ■ **There is dust or dirt on the ADF or originals.**

#### **Solutions**

Clean the ADF, and remove any dust or dirt that adheres to the originals.

➔ [“Cleaning the ADF” on page 265](#)

### ■ **The original was pressed with too much force.**

#### **Solutions**

If you press with too much force, blurring, smudges, and spots may occur.

Do not press with too much force on the original or the document cover.

➔ [“Placing Originals” on page 145](#)

### ■ **The copy density setting is too high.**

#### **Solutions**

Lower the copy density setting.

➔ [“Basic Menu Options for Copying” on page 203](#)



## Moiré (Cross-Hatch) Patterns Appear in the Copied Image

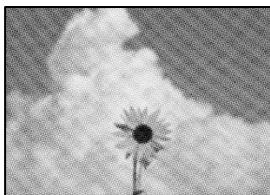

**If the original is a printed document such as a magazine or a catalog, a dotted moiré pattern appears.**

### Solutions

Change the reduce and enlarge setting. If a moiré pattern still appears, place the original at a slightly different angle.

➔ [“Basic Menu Options for Copying” on page 203](#)

## An Image of the Reverse Side of the Original Appears in the Copied Image



The following causes can be considered.

**When scanning thin originals, images on the back may be scanned at the same time.**

### Solutions

Place the original on the scanner glass and then place a piece of black paper over it.

➔ [“Placing Originals” on page 145](#)

**The copy density setting is too high.**

### Solutions

Lower the copy density setting.

➔ [“Basic Menu Options for Copying” on page 203](#)

## Scanned Image Problems

### Uneven Colors, Dirt, Spots, and so on Appear when Scanning from the Scanner Glass



#### There is dust or dirt on the originals or the scanner glass.

##### Solutions

Remove any dust or dirt that adheres to the originals, and clean the scanner glass.

➔ [“Cleaning the Scanner Glass” on page 265](#)

#### The original was pressed with too much force.

##### Solutions

If you press with too much force, blurring, smudges, and spots may occur.

Do not press with too much force on the original or the document cover.

➔ [“Placing Originals” on page 145](#)

### Straight Lines Appear when Scanning from ADF

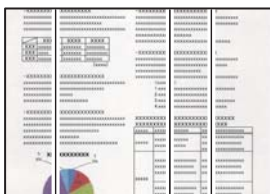

#### There is dust or dirt on the ADF or originals.

##### Solutions

Clean the ADF, and remove any dust or dirt that adheres to the originals.

➔ [“Cleaning the ADF” on page 265](#)

## Offset Appears in the Background of Scanned Images

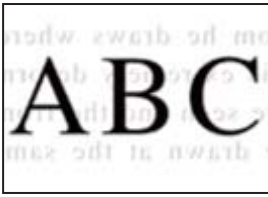

### ■ When scanning thin originals, images on the back may be scanned at the same time.

#### Solutions

When scanning from the scanner glass, place black paper or a desk pad over the original.

➔ [“Placing Originals” on page 145](#)

## Cannot Scan the Correct Area on the Scanner Glass



### ■ The originals are not placed correctly.

#### Solutions

- Make sure the original is placed correctly against the alignment marks.
- If the edge of the scanned image is missing, move the original slightly away from the edge of the scanner glass. You cannot scan the area within approximately 1.5 mm (0.06 in.) from the edge of the scanner glass.

➔ [“Placing Originals” on page 145](#)

### ■ There is dust or dirt on the scanner glass.

#### Solutions

Remove any trash or dirt from the scanner glass and document cover. If there is any trash or dirt around the original, the scanning range expands to include it.

## Cannot Solve Problems in the Scanned Image

Check the following if you have tried all of the solutions and have not solved the problem.

### ■ There are problems with the scanning software settings.

#### Solutions

Use Epson Scan 2 Utility to initialize the settings for the scanner software.

#### *Note:*

*Epson Scan 2 Utility is an application supplied with the scanner software.*

1. Start the Epson Scan 2 Utility.
  - Windows 11  
Click the start button, and then select **All apps > EPSON > Epson Scan 2 Utility**.
  - Windows 10  
Click the start button, and then select **EPSON > Epson Scan 2 Utility**.
  - Windows 8.1/Windows 8  
Enter the application name in the search charm, and then select the displayed icon.
  - Windows 7  
Click the start button, and then select **All Programs or Programs > EPSON > Epson Scan 2 > Epson Scan 2 Utility**.
  - Mac OS  
Select **Go > Applications > Epson Software > Epson Scan 2 Utility**.
2. Select the **Other** tab.
3. Click **Reset**.

If initialization does not solve the problem, uninstall and re-install the scanner software.

➔ [“Installing or Uninstalling Applications Separately” on page 272](#)

## The Quality of the Sent Fax is Poor

### Quality of the Sent Fax is Poor



The following causes can be considered.

#### ■ **There is dust or dirt on the originals or the scanner glass.**

##### **Solutions**

Remove any dust or dirt that adheres to the originals, and clean the scanner glass.

➔ [“Cleaning the Scanner Glass” on page 265](#)

#### ■ **The original was pressed with too much force.**

##### **Solutions**

If you press with too much force, blurring, smudges, and spots may occur.

Do not press with too much force on the original or the document cover.

➔ [“Placing Originals” on page 145](#)

## Straight Lines Appear when Sending Faxes from the ADF

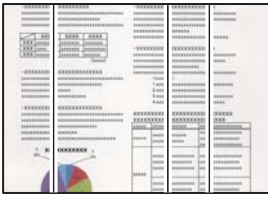

### There is dust or dirt on the ADF or originals.

#### Solutions

Clean the ADF, and remove any dust or dirt that adheres to the originals.

➔ [“Cleaning the ADF” on page 265](#)

## The Image Quality of the Sent Fax is Poor

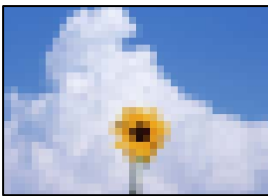

The following causes can be considered.

### The Original Type setting is wrong.

#### Solutions

Select **Fax > Fax Settings > Scan Settings > Original Type**, and then change the setting. When the original you are sending contains text and images, set this to **Photo**.

### The resolution is set to low.

#### Solutions

If you do not know the performance of the sender's fax machine, set the following before sending a fax.

Select **Fax > Fax Settings** and then make the **Resolution** setting to set the highest quality image.

Select **Fax > Fax Settings** and then enable **Direct Send**.

Note that if you set **Resolution** to **Super Fine** or **Ultra Fine** but you send the fax without enabling **Direct Send**, the fax may be sent at a lower resolution.

### Image Quality of Sent Faxes does not Improve After Trying the Solutions Above

#### Solutions

If you cannot solve the problem, contact your printer administrator. For printer administrators, see the following section to troubleshoot fax problems.

➔ [“The Quality of the Sent or Received Fax is Poor” on page 136](#)

## An Image of the Reverse Side of the Original Appears in the Sent Fax



The following causes can be considered.

### ■ When scanning thin originals, images on the back may be scanned at the same time.

#### Solutions

Place the original on the scanner glass and then place a piece of black paper over it.

➔ [“Placing Originals” on page 145](#)

### ■ The density setting is high when sending faxes.

#### Solutions

Select **Fax** > **Fax Settings** > **Scan Settings** > **Density**, and then lower the setting.

## Received Fax Quality is Poor

### The Image Quality of Received Faxes is Poor



The following causes can be considered.

### ■ The image quality setting is low on the sender's fax machine.

#### Solutions

Ask the sender to send faxes at a higher quality.

### ■ Image Quality of Received Faxes does not Improve After Trying the Solutions Above

#### Solutions

If you cannot solve the problem, contact your printer administrator. For printer administrators, see the following section to troubleshoot fax problems.



➔ [“The Quality of the Sent or Received Fax is Poor” on page 136](#)

## A Message or Error Code is Displayed on the LCD Screen

### A Message is Displayed on the LCD Screen

If an error message is displayed on the LCD screen, follow the on-screen instructions or the solutions below to solve the problem. If a message is displayed when you cannot scan to the shared folder from the control panel, see the related information below.

Error Messages	Solutions
Printer error. Turn the power off and on again. If the problem persists, contact Epson Support.	<ul style="list-style-type: none"> <li><input type="checkbox"/> Remove any paper or protective material in the printer and the paper cassette. If the error message is still displayed after turning the power off and on again, contact Epson support.</li> <li><input type="checkbox"/> When the following error codes are displayed, check the paper for the maximum number of sheets that can be loaded in each paper source. 000181, 000184</li> </ul>
Paper out in XX. Load paper. Paper Size: XX/ Paper Type: XX	Load paper, and then insert the paper cassette all the way.
Too many paper cassette units are installed. Turn the power off and uninstall the extra units. See your documentation for details.	You can install up to three optional paper cassette unit. For other optional paper cassette units, uninstall them by following the reverse steps to installation.
Cannot print because XX is out of order. You can print from another cassette.	Turn the power off and on again, and then reinsert the paper cassette. If the error message is still displayed, contact Epson support or an authorised Epson service provider to request repairs.
The pickup roller in XX is nearing the end of its service life.	The pickup rollers need to be replaced periodically. Paper is not fed correctly from the paper cassette when it is time for replacement. Prepare new pickup rollers.
The pickup roller in XX has reached the end of its service life.	Replace the pickup rollers. After replacing the rollers, select <b>Settings &gt; Maintenance &gt; Pickup roller information &gt; Reset Counter</b> , and then select the paper cassette for which you replaced the pickup rollers.
You need to replace Ink Supply Unit.	To ensure you receive premium print quality and to help protect your print head, a variable ink safety reserve remains in the ink supply unit when your printer indicates it is time to replace the ink supply unit. Replace with a new ink supply unit.
Paper Setup Auto Display is set to Off. Some features may not be available. For details, see your documentation.	If <b>Paper Setup Auto Display</b> is disabled, you cannot use AirPrint.
No dial tone is detected.	<p>This problem might be resolved by selecting <b>Settings &gt; General Settings &gt; Fax Settings &gt; Basic Settings &gt; Line Type</b>, and then selecting <b>PBX</b>. If your phone system requires an external access code to get an outside line, set the access code after selecting <b>PBX</b>. Use # (hash) instead of the actual access code when entering an outside fax number. This makes connection more secure.</p> <p>If the error message is still displayed, set the <b>Dial Tone Detection</b> settings to disabled. However, disabling this feature may drop the first digit of a fax number and send the fax to the wrong number.</p>

Error Messages	Solutions
Failed to receive faxes because the fax data capacity is full. Touch the Job/Status at the bottom of the Home Screen for details.	<p>Received faxes may accumulate without being processed due to the following reasons.</p> <ul style="list-style-type: none"> <li><input type="checkbox"/> Cannot print because a printer error has occurred. Clear the printer error. To check the details and solutions to the error, press the  button and then select <b>Printer</b>.</li> <li><input type="checkbox"/> Cannot save in the computer or the memory device. To check whether or not received faxes have been saved, press the  button and then select <b>Job</b>. To save received faxes, turn on the computer or connect a memory device to the printer.</li> </ul>
The combination of the IP address and the subnet mask is invalid. See your documentation for more details.	Contact your printer administrator.
To use cloud services, update the root certificate from the Epson Web Config utility.	Contact your printer administrator.
Check that the printer driver is installed on the computer and that the port settings for the printer are correct.	<p>Make sure the printer port is selected correctly in <b>Property &gt; Port</b> from the <b>Printer</b> menu as follows.</p> <p>Select "<b>USBXXX</b>" for a USB connection, or "<b>EpsonNet Print Port</b>" for a network connection.</p>
Paper feed error. Remove C1, make sure there is no jammed paper remaining in the printer, and reload the paper.	<p>Pull out paper cassette1, remove the jammed paper from inside the printer, and then re-insert the paper cassette.</p> <p>Even if you cannot feed the paper, check the position of the pickup roller lock. If the position is wrong, push the pickup roller lock with your finger to correct the position. See the Web Movie Manuals for the position of the pickup roller lock.</p> <p><a href="https://support.epson.net/publist/vlink.php?code=NPD7274">https://support.epson.net/publist/vlink.php?code=NPD7274</a></p> <p>For users in China, access the following website.</p> <p><a href="https://support.epson.net/publist/vlink.php?code=NPD7275">https://support.epson.net/publist/vlink.php?code=NPD7275</a></p>
Recovery Mode Update Firmware	Contact your printer administrator.

### Related Information

➔ [“Messages are Displayed on the Control Panel when Scanning to a Network Folder” on page 85](#)

## Error Code is Displayed on the Status Menu

If a job does not complete successfully, check the error code displayed on the history of each job. You can check the error code by pressing the  button, and then selecting **Job**. See the following table to find the problem and its solution.

Code	Problem	Solution
001	The product was turned off by a power failure.	-



Code	Problem	Solution
101	The memory is full.	<p>Try the methods below to reduce the size of the print job.</p> <ul style="list-style-type: none"> <li><input type="checkbox"/> Lower the print quality and the resolution.</li> <li><input type="checkbox"/> Change the format setting.</li> <li><input type="checkbox"/> Reduce the number of images, letters or fonts used in the print job.</li> </ul>
102	Collated printing has failed due to a lack of available memory.	<ul style="list-style-type: none"> <li><input type="checkbox"/> Select <b>Settings &gt; General Settings &gt; System Administration &gt; Clear Internal Memory Data &gt; PDL Font, Macro, and Working Area</b>, and then clear the fonts and the macros that you have downloaded.</li> <li><input type="checkbox"/> Try the methods below to reduce the size of the print job. If you do not want to use these methods, try printing one copy at a time. <ul style="list-style-type: none"> <li><input type="checkbox"/> Lower the print quality and the resolution.</li> <li><input type="checkbox"/> Change the format setting.</li> <li><input type="checkbox"/> Reduce the number of images, letters or fonts used in the print job.</li> </ul> </li> </ul>
103	Printing quality has been lowered due to a lack of available memory.	<p>If you do not want to lower the print quality, try the following methods to reduce the size of the print job.</p> <ul style="list-style-type: none"> <li><input type="checkbox"/> Change the format setting.</li> <li><input type="checkbox"/> Reduce the number of images, letters or fonts used in the print job.</li> </ul>
104	Reverse printing has failed due to a lack of available memory.	<ul style="list-style-type: none"> <li><input type="checkbox"/> Select <b>Settings &gt; General Settings &gt; System Administration &gt; Clear Internal Memory Data &gt; PDL Font, Macro, and Working Area</b>, and then clear the fonts and the macros that you have downloaded.</li> <li><input type="checkbox"/> If you want to print in reverse, try the following methods to reduce the size of the print job. <ul style="list-style-type: none"> <li><input type="checkbox"/> Lower the print quality and the resolution.</li> <li><input type="checkbox"/> Change the format setting.</li> <li><input type="checkbox"/> Reduce the number of images, letters or fonts used in the print job.</li> </ul> </li> </ul>
106	Cannot print from the computer due to the access control settings.	Contact your printer administrator.
107	User authentication failed. The job has been canceled.	<ul style="list-style-type: none"> <li><input type="checkbox"/> Make sure that the user name and password are correct.</li> <li><input type="checkbox"/> Select <b>Settings &gt; General Settings &gt; System Administration &gt; Security Settings &gt; Access Control</b>. Enable the user restriction function, and then allow the job without an authentication information.</li> </ul>

Code	Problem	Solution
108	Confidential job data was deleted when the printer was turned off.	-
109	The received fax was already deleted.	-
110	The job was printed on one side only because the paper loaded does not support double sided printing.	If you want to perform 2-sided printing, load paper that supports 2-sided printing.
111	Available memory is running low.	Try the methods below to reduce the size of the print job. <ul style="list-style-type: none"> <li><input type="checkbox"/> Lower the print quality and the resolution.</li> <li><input type="checkbox"/> Change the format setting.</li> <li><input type="checkbox"/> Reduce the number of images, letters or fonts used in the print job.</li> </ul>
120	Cannot communicate with the server that is connected using an open platform.	Make sure there are no errors on the server or the network.
130	Collated printing has failed due to a lack of available memory.	Try the methods below to reduce the size of the print job. If you do not want to use these methods, try printing one copy at a time. <ul style="list-style-type: none"> <li><input type="checkbox"/> Lower the print quality and the resolution.</li> <li><input type="checkbox"/> Change the format setting.</li> <li><input type="checkbox"/> Reduce the number of images, letters or fonts used in the print job.</li> </ul>
131	Reverse printing has failed due to a lack of available memory.	If you want to print in reverse, try the following methods to reduce the size of the print job. <ul style="list-style-type: none"> <li><input type="checkbox"/> Lower the print quality and the resolution.</li> <li><input type="checkbox"/> Change the format setting.</li> <li><input type="checkbox"/> Reduce the number of images, letters or fonts used in the print job.</li> </ul>
132	Cannot print due to a lack of available memory.	Try the methods below to reduce the size of the print data. <ul style="list-style-type: none"> <li><input type="checkbox"/> Change to a smaller paper size.</li> <li><input type="checkbox"/> Simplify the data by reducing the number of images in the print data or reducing the number of font types.</li> </ul>
133	Cannot print on 2-sides due to a lack of available memory. Only one side will be printed.	Try the methods below to reduce the size of the print data. <ul style="list-style-type: none"> <li><input type="checkbox"/> Change to a smaller paper size.</li> <li><input type="checkbox"/> Simplify the data by reducing the number of images in the print data or reducing the number of font types.</li> </ul>
141	Error in the printer's HDD. The job has been canceled.	Contact Epson support or an authorized Epson service provider to replace the HDD.
151	Printing is not performed because the login user name and the user name associated with the confidential job do not match.	Make sure you login with the same user name as the user name associated with the confidential job.

Code	Problem	Solution
201	The memory is full.	<ul style="list-style-type: none"> <li><input type="checkbox"/> Print received faxes from <b>Job</b> in <b>Job/Status</b> .</li> <li><input type="checkbox"/> Delete received faxes saved in the inbox from <b>Job</b> in <b>Job/Status</b>.</li> <li><input type="checkbox"/> If you are sending a monochrome fax to a single destination, you can send it by using Direct Send.</li> <li><input type="checkbox"/> Divide your originals in two or more to send them in several batches.</li> </ul>
202	The line was disconnected by the recipient machine.	Wait for a while and then try again.
203	The product cannot detect the dial tone.	<ul style="list-style-type: none"> <li><input type="checkbox"/> Make sure that the phone cable is connected correctly and the phone line is working.</li> <li><input type="checkbox"/> When the printer is connected to the PBX or the terminal adapter, change the <b>Line Type</b> setting to <b>PBX</b>.</li> <li><input type="checkbox"/> Select <b>Settings &gt; General Settings &gt; Fax Settings &gt; Basic Settings &gt; Dial Tone Detection</b>, and then disable the dial tone setting.</li> </ul>
204	The recipient machine is busy.	<ul style="list-style-type: none"> <li><input type="checkbox"/> Wait for a while and then try again.</li> <li><input type="checkbox"/> Check the recipient's fax number.</li> </ul>
205	The recipient machine does not answer.	Wait for a while and then try again.
206	The phone cable is incorrectly connected to the LINE and EXT. port of the product.	Check the connection of the LINE port and the EXT. port of the printer.
207	The product is not connected to the phone line.	Connect the phone cable to the phone line.
208	The fax could not be sent to some of the specified recipients.	Print a <b>Fax Log</b> or <b>Last Transmission</b> report for previous faxes from <b>Fax Report</b> in the Fax mode to check the failed destination. When the <b>Save Failure Data</b> setting is enabled, you can resend a fax from <b>Job</b> in <b>Job/Status</b> .
301	There is not enough storage space available to save the data in the memory device.	<ul style="list-style-type: none"> <li><input type="checkbox"/> Increase the storage space in the memory device.</li> <li><input type="checkbox"/> Reduce the number of documents.</li> <li><input type="checkbox"/> Lower the scanning resolution or increase the compression ratio to reduce the size of the scanned image.</li> </ul>
302	The memory device is write-protected.	Disable write protection on the memory device.
303	No folder has been created to save the scanned image.	Insert another memory device.
304	The memory device has been removed.	Reinsert the memory device.
305	An error occurred while saving the data to the memory device.	If the external device is accessed from a computer, wait for a while and then try again.
306	The memory is full.	Wait until other ongoing jobs are finished.

Code	Problem	Solution
311	A DNS error has occurred.	<ul style="list-style-type: none"> <li><input type="checkbox"/> Select <b>Settings &gt; General Settings &gt; Network Settings &gt; Advanced &gt; TCP/IP</b>, and then check the DNS settings.</li> <li><input type="checkbox"/> Check the DNS settings for the server, the computer, or the access point.</li> </ul>
312	An authentication error has occurred.	Select <b>Settings &gt; General Settings &gt; Network Settings &gt; Advanced &gt; Email Server &gt; Server Settings</b> , and then check the server settings.
313	A communication error has occurred.	<ul style="list-style-type: none"> <li><input type="checkbox"/> Print a network connection report to check if the printer is connected to the network.</li> <li><input type="checkbox"/> Select <b>Settings &gt; General Settings &gt; Network Settings &gt; Advanced &gt; Email Server &gt; Server Settings</b> to check the email server settings. You can check the cause of the error by running connection check.</li> <li><input type="checkbox"/> The authentication method of the settings and the email server may not match. When you select <b>Off</b> as the authentication method, make sure the authentication method of the email server is set to None.</li> </ul>
314	The data size exceeds the maximum size for attached files.	<ul style="list-style-type: none"> <li><input type="checkbox"/> Increase the <b>Attached File Max Size</b> setting in the scan settings.</li> <li><input type="checkbox"/> Lower the scanning resolution or increase the compression ratio to reduce the size of the scanned image.</li> </ul>
315	The memory is full.	Retry after other ongoing jobs are finished.
316	A mail encryption error has occurred.	<ul style="list-style-type: none"> <li><input type="checkbox"/> Make sure that the encryption certificate setting is correct.</li> <li><input type="checkbox"/> Make sure that the printer's time setting is correct.</li> </ul>
317	A mail signature error has occurred.	<ul style="list-style-type: none"> <li><input type="checkbox"/> Make sure that the signing certificate setting is correct.</li> <li><input type="checkbox"/> Make sure that the printer's time setting is correct.</li> </ul>
318	A domain restriction error has occurred.	Contact your administrator to check if the domain of your email destination is restricted.
321	A DNS error has occurred.	<ul style="list-style-type: none"> <li><input type="checkbox"/> Select <b>Settings &gt; General Settings &gt; Network Settings &gt; Advanced &gt; TCP/IP</b>, and then check the DNS settings.</li> <li><input type="checkbox"/> Check the DNS settings for the server, the computer, or the access point.</li> </ul>
322	An authentication error has occurred.	Check the <b>Location</b> settings.
323	A communication error has occurred.	<ul style="list-style-type: none"> <li><input type="checkbox"/> Check the <b>Location</b> settings.</li> <li><input type="checkbox"/> Print a network connection report to check if the printer is connected to the network.</li> </ul>
324	A file with the same name already exists in the specified folder.	<ul style="list-style-type: none"> <li><input type="checkbox"/> Delete the file with the same name.</li> <li><input type="checkbox"/> Change the file name prefix in <b>File Settings</b>.</li> </ul>

Code	Problem	Solution
325	There is not enough storage space available in the specified folder.	<ul style="list-style-type: none"> <li><input type="checkbox"/> Increase the storage space in the specified folder.</li> <li><input type="checkbox"/> Reduce the number of documents.</li> <li><input type="checkbox"/> Lower the scanning resolution or increase the compression ratio to reduce the size of the scanned image.</li> </ul>
327	The memory is full.	Wait until other ongoing jobs are finished.
328	The destination was wrong or the destination does not exist.	Check the <b>Location</b> settings.
330	An FTPS/FTPS secure connection error has occurred.	<ul style="list-style-type: none"> <li><input type="checkbox"/> Check the location in the destination settings.</li> <li><input type="checkbox"/> Run Web Config, and then update the root certificate.</li> <li><input type="checkbox"/> Run Web Config, and then import or update the CA certificate.</li> </ul> <p>If the error cannot be cleared, set the certificate verification to off in the destination settings.</p>
331	A communication error occurred while acquiring the destination list.	Print a network connection report to check if the printer is connected to the network.
332	There is not enough storage space available to save the scanned image in the destination storage.	Reduce the number of documents.
333	The destination could not be found because the destination information was uploaded to the server before sending the scanned image.	Select the destination again.
334	An error occurred while sending the scanned image.	-
341	A communication error has occurred.	<ul style="list-style-type: none"> <li><input type="checkbox"/> Check the connections for the printer and the computer. If you are connecting over a network, print a network connection report to check if the printer is connected to the network.</li> <li><input type="checkbox"/> Make sure that Document Capture Pro is installed on the computer.</li> </ul>
350	An FTPS/HTTPS certificate error has occurred.	<ul style="list-style-type: none"> <li><input type="checkbox"/> Make sure that the date/time and time difference settings are correct.</li> <li><input type="checkbox"/> Run Web Config, and then update the root certificate.</li> <li><input type="checkbox"/> Run Web Config, and then import or update the CA certificate.</li> </ul> <p>If the error cannot be cleared, set the certificate verification to off in the destination settings.</p>
401	There is not enough storage space available to save the data in the memory device.	Increase the storage space in the memory device.
402	The memory device is write-protected.	Disable write protection on the memory device.
404	The memory device has been removed.	Reinsert the memory device.

Code	Problem	Solution
405	An error occurred while saving the data to the memory device.	<ul style="list-style-type: none"> <li><input type="checkbox"/> Reinsert the memory device.</li> <li><input type="checkbox"/> Use a different memory device on which you have created a folder using the <b>Create a folder to save fax data</b> function.</li> </ul>
411	A DNS error has occurred.	<ul style="list-style-type: none"> <li><input type="checkbox"/> Select <b>Settings &gt; General Settings &gt; Network Settings &gt; Advanced &gt; TCP/IP</b>, and then check the DNS settings.</li> <li><input type="checkbox"/> Check the DNS settings for the server, the computer, or the access point.</li> </ul>
412	An authentication error has occurred.	Select <b>Settings &gt; General Settings &gt; Network Settings &gt; Advanced &gt; Email Server &gt; Server Settings</b> , and then check the server settings.
413	A communication error has occurred.	<ul style="list-style-type: none"> <li><input type="checkbox"/> Select <b>Settings &gt; General Settings &gt; Network Settings &gt; Advanced &gt; Email Server &gt; Server Settings</b> to check the email server settings. You can check the cause of the error by running connection check.</li> <li><input type="checkbox"/> The authentication method of the settings and the email server may not match. When you select <b>Off</b> as the authentication method, make sure the authentication method of the email server is set to None.</li> <li><input type="checkbox"/> Print a network connection report to check if the printer is connected to the network.</li> </ul>
421	A DNS error has occurred.	<ul style="list-style-type: none"> <li><input type="checkbox"/> Select <b>Settings &gt; General Settings &gt; Network Settings &gt; Advanced &gt; TCP/IP</b>, and then check the DNS settings.</li> <li><input type="checkbox"/> Check the DNS settings for the server, the computer, or the access point.</li> </ul>
422	An authentication error has occurred.	Select <b>Settings &gt; General Settings &gt; Fax Settings &gt; Receive Settings &gt; Save/Forward Settings</b> , and then check the settings of the folder selected in <b>Save/Forward Destination</b> .
423	A communication error has occurred.	<ul style="list-style-type: none"> <li><input type="checkbox"/> Print a network connection report to check if the printer is connected to the network.</li> <li><input type="checkbox"/> Select <b>Settings &gt; General Settings &gt; Fax Settings &gt; Receive Settings &gt; Save/Forward Settings</b>, and then check the settings of the folder selected in <b>Save/Forward Destination</b>.</li> </ul>
425	There is not enough storage space available in the forwarding destination folder.	Increase the storage space in the forwarding destination folder.
428	The destination was wrong or the destination does not exist.	Select <b>Settings &gt; General Settings &gt; Fax Settings &gt; Receive Settings &gt; Save/Forward Settings</b> , and then check the settings of the folder selected in <b>Save/Forward Destination</b> .

## Paper Gets Jammed

Check the error displayed on the control panel and follow the instructions to remove the jammed paper including any torn pieces. The LCD screen displays an animation that shows you how to remove jammed paper.



**Caution:**

*Never touch the buttons on the control panel while your hand is inside the printer. If the printer starts operating, it could cause an injury. Be careful not to touch the protruding parts to avoid injury.*



**Important:**

*Remove the jammed paper carefully. Removing the paper vigorously may cause damage to the printer.*

## Preventing Paper Jams

Check the following if paper jams occur frequently.

- Place the printer on a flat surface and operate in the recommended environmental conditions.  
[“Environmental Specifications” on page 403](#)
- Use the paper supported by this printer.  
[“Available Paper and Capacities” on page 344](#)
- Follow paper handling precautions.  
[“Paper Handling Precautions” on page 140](#)
- Load paper in the correct direction, and slide the edge guide against the edge of the paper.  
[“Loading Paper” on page 142](#)
- Do not load more than the maximum number of sheets specified for paper.
- Load one sheet of paper at a time if you have loaded several sheets of paper.
- Make sure the paper size and paper type settings match the actual paper size and paper type loaded in the printer.  
[“List of Paper Type” on page 141](#)

---

## It is Time to Replace Ink Supply Units

### Ink Supply Unit Handling Precautions

#### Storing precautions for ink

- Keep the ink supply units out of direct sunlight.
- Do not store the ink supply units in high or freezing temperatures.
- Epson recommends using the ink supply unit before the date printed on the package.
- For best results, store ink supply unit packages with their bottom down.

- ❑ After bringing an ink supply unit inside from a cold storage site, allow it to warm up at room temperature for at least 12 hours before using it.
- ❑ Do not drop or knock the ink supply unit against hard objects; otherwise, the ink may leak.

### Handling precautions for replacing ink

- ❑ Do not touch the sections shown in the illustration. Doing so may prevent normal operation and printing.

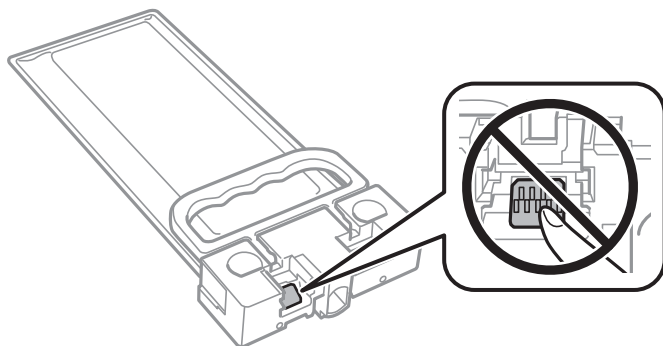

- ❑ Do not turn off the printer during ink charging. If the ink charging is incomplete, you may not be able to print.
- ❑ Do not leave the printer with the ink supply unit removed; otherwise, ink remaining in the print head nozzles may dry out and you may not be able to print.
- ❑ If you need to remove an ink supply unit temporarily, make sure you protect the ink supply area from dirt and dust. Store the ink supply unit in the same environment as the printer. Because the ink supply port is equipped with a valve designed to contain the release of excess ink, there is no need to supply your own covers or plugs.
- ❑ Removed ink supply unit may have ink around the ink supply port, so be careful not to get any ink on the surrounding area when removing the ink supply unit.
- ❑ This printer uses an ink supply unit equipped with a green chip that monitors information such as the amount of remaining ink. This means that even if the ink supply unit is removed from the printer before it is expended, you can still use the ink supply unit after reinserting it back into the printer.
- ❑ To ensure you receive premium print quality and to help protect your print head, a variable ink safety reserve remains in the ink supply unit when your printer indicates to replace the ink supply unit. The yields quoted for you do not include this reserve.
- ❑ Do not disassemble or remodel the ink supply unit, otherwise you may not be able to print normally.
- ❑ You cannot use the ink supply unit that came with the printer for the replacement.
- ❑ If the ink supply unit has changed shape due to being dropped and so on, fix the shape before inserting it in the printer; otherwise, it may not be set correctly.

### Consumption of ink

- ❑ To maintain optimum print head performance, some ink is consumed from the ink supply unit during maintenance operations such as print head cleaning. Ink may also be consumed when you turn the printer on.
- ❑ The ink in the ink supply unit supplied with your printer is partly used during initial setup. In order to produce high quality printouts, the print head in your printer will be fully charged with ink. This one-off process consumes a quantity of ink and therefore the ink supply unit may print fewer pages compared to subsequent ink supply unit.
- ❑ Quoted yields may vary depending on the images that you are printing, the paper type that you are using, the frequency of your prints and environmental conditions such as temperature.
- ❑ For best results, use up ink supply unit within two years of installation.



## Replacing Ink Supply Units

When a message is displayed prompting you to replace the ink supply units, select **How To...** and then view the animations displayed on the control panel to learn how to replace the ink supply units.

### Related Information

- ➔ [“Ink Supply Unit Codes” on page 347](#)
- ➔ [“Ink Supply Unit Handling Precautions” on page 331](#)

---

## It is Time to Replace the Maintenance Box

### Maintenance Box Handling Precautions

Read the following instructions before replacing the maintenance box.

- Do not touch the green chip on the side of the maintenance box. Doing so may prevent normal operation and printing.
- Do not drop the maintenance box or subject it to strong shocks.
- Do not replace the maintenance box during printing; otherwise, ink may leak.
- Do not remove the maintenance box and its cover except when replacing the maintenance box; otherwise ink may leak.
- Do not tilt the used maintenance box until after it is sealed in the plastic bag; otherwise ink may leak.
- Do not touch the openings in the maintenance box as you may get smeared with ink.
- Do not reuse a maintenance box which has been removed and left detached for a long period. Ink inside the box will have solidified and no more ink can be absorbed.
- Keep the maintenance box out of direct sunlight.
- Do not store the maintenance box in high or freezing temperatures.

### Replacing a Maintenance Box

In some print cycles a very small amount of surplus ink may be collected in the maintenance box. To prevent ink leakage from the maintenance box, the printer is designed to stop printing when the absorbing capacity of the maintenance box has reached its limit. Whether and how often this is required will vary according to the number of pages you print, the type of material that you print and the number of cleaning cycles that the printer performs.

When a message is displayed prompting you to replace the maintenance box, refer to the animations displayed on the control panel. The need for replacement of the box does not mean that your printer has ceased to operate in

accordance with its specifications. The Epson warranty does not cover the cost of this replacement. It is a user-serviceable part.

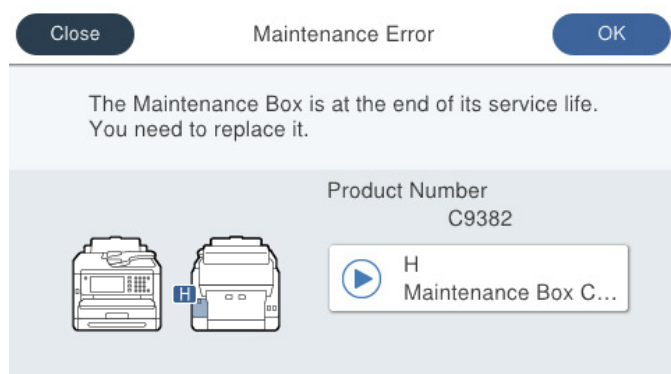

**Note:**

- ❑ When the maintenance box is full, you cannot print and clean the print head until it is replaced to avoid ink leakage. However, you can perform operations that do not use ink such as scanning.

**Related Information**

- ➔ “Maintenance Box Code” on page 348
- ➔ “Maintenance Box Handling Precautions” on page 333

---

## It is Time to Replace the Pickup Rollers

### Replacing Pickup Rollers for the Paper Cassette Unit

See the slip sheet supplied with the pickup roller's carton box to replace the pickup rollers for the paper cassette unit.

▶ You can also watch the procedure in the Web Movie Manuals. Access the following website.

<https://support.epson.net/publist/vlink.php?code=NPD6983>

For users in China, access the following website.

<https://support.epson.net/publist/vlink.php?code=NPD7068>

**Related Information**

- ➔ “Pickup Rollers Code” on page 348

### Replacing Pickup Rollers for the Optional Paper Cassette Units

See the slip sheet supplied with the pickup roller's carton box to replace the pickup rollers for the optional paper cassette units.

▶ You can also watch the procedure in the Web Movie Manuals. Access the following website.

<https://support.epson.net/publist/vlink.php?code=NPD6985>

For users in China, access the following website.

<https://support.epson.net/publist/vlink.php?code=NPD7070>

#### **Related Information**

➔ [“Pickup Rollers Code” on page 348](#)

---

## **Cannot Operate the Printer as Expected**

### **The Printer Does Not Turn On or Off**

#### **Power Does Not Turn On**

The following causes can be considered.

##### **■ The power cord is not plugged in properly to the electrical outlet.**

###### **Solutions**

Make sure the power cord is securely plugged in.

##### **■ The button was not pressed for long enough.**



###### **Solutions**

Hold down the  button for a little longer.

#### **Power Does Not Turn Off**

##### **■ The button was not pressed for long enough.**

###### **Solutions**

Hold down the  button for a little longer. If you still cannot turn off the printer, unplug the power cord. To prevent the print head from drying out, turn the printer back on and turn it off by pressing the  button.

#### **Power Turns Off Automatically**

##### **■ The Power Off Settings or Power Off Timer feature is enabled.**

###### **Solutions**

- Select **Settings > General Settings > Basic Settings > Power Off Settings**, and then disable the **Power Off If Inactive** and **Power Off If Disconnected** settings.
- Select **Settings > General Settings > Basic Settings**, and then disable the **Power Off Timer** Setting.

###### **Note:**

*Your product may have the **Power Off Settings** or **Power Off Timer** feature depending on the location of purchase.*

## Operations are Slow

### Printing Is Too Slow

The following causes can be considered.

#### ■ Unnecessary applications are running.

##### Solutions

Close any unnecessary applications on your computer or smart device.

#### ■ The print quality is set to high.

##### Solutions

Lower the quality setting.

#### ■ Bidirectional printing is disabled.

##### Solutions

Enable the bidirectional (or high speed) setting. When this setting is enabled, the print head prints while moving in both directions, and the printing speed increases.

##### Control panel

Select **Settings > General Settings > Printer Settings**, and then enable **Bidirectional**.

##### Windows

Select **Bidirectional Printing** on the printer driver's **More Options** tab.

##### Mac OS

Select **System Preferences** from the Apple menu > **Printers & Scanners** (or **Print & Scan, Print & Fax**), and then select the printer. Click **Options & Supplies > Options** (or **Driver**). Select **On** as the **Bidirectional Printing** setting.

#### ■ Quiet Mode is enabled.

##### Solutions

Disable **Quiet Mode**. The printing speed slows down when the printer is running in **Quiet Mode**.

##### Control panel

Select  on the home screen, and then select **Off**.

##### Windows

Select **Off** as the **Quiet Mode** setting on the printer driver's **Main** tab.

##### Mac OS

Select **System Preferences** from the Apple menu > **Printers & Scanners** (or **Print & Scan, Print & Fax**), and then select the printer. Click **Options & Supplies > Options** (or **Driver**). Select **Off** as the **Quiet Mode** setting.

### ■ **Drying takes a while for 2-sided printing.**

#### **Solutions**

For 2-sided printing, one side of paper is printed and dried, and then the other side is printed. Because the drying time differs depending on the environment, such as temperature or humidity, or the print data, the printing speed may be slower.

### **Printing Slows Down Dramatically During Continuous Printing**

### ■ **The function that prevents the printer mechanism from overheating and being damaged is operating.**

#### **Solutions**

You can continue printing. To return to normal printing speed, leave the printer idle for at least 30 minutes. Printing speed does not return to normal if the power is off.

### **Printing Is Too Slow While Using PostScript Printer Driver**

### ■ **The Print quality setting is high.**

#### **Solutions**

Set the **Print Quality** setting to **Fast** in the printer driver.

### **Scanning Speed Is Slow**

### ■ **Scanning at a high resolution.**

#### **Solutions**

Try scanning at a lower resolution.

### **LCD Screen Gets Dark**

### ■ **The printer is in sleep mode.**

#### **Solutions**

Tap anywhere on the LCD screen to return it to its former state.

If you have disabled **Touch LCD Screen to Wake**, press the  button.

### **Touch Screen Does Not Respond**

The following causes can be considered.

### ■ **A protective sheet has been stuck on the touch screen.**

#### **Solutions**

If you stick a protective sheet on the touch screen, the optical touch screen may not respond. Remove the sheet.

### ■ **The screen is smeared.**

#### **Solutions**

Turn off the printer, and then wipe the screen using a soft, dry cloth. If the screen is smeared, it may not respond.

## **Cannot Operate from the Control Panel**

### ■ **When the user feature restriction is enabled, a user ID and password are required to print.**

#### **Solutions**

If you do not know the password, contact your printer administrator.

## **"x" is Displayed on the Screen and you Cannot Select Photos**

### ■ **The image file is not supported.**

#### **Solutions**

"x" is displayed on the LCD screen when the image file is not supported by the product. Use files supported by the product.

➔ [“Supported Data Specifications” on page 401](#)

### ■ **The file name is too long to be recognized by the printer.**

#### **Solutions**

You can print photos by saving the image files on the memory device to your computer or smart device. For smart devices, you can print using Epson Smart Panel.

## **Memory Device Is not Recognized**

### ■ **The memory device is set to disabled.**

#### **Solutions**

On the control panel, select **Settings > General Settings > Printer Settings > Memory Device Interface**, and then enable the memory device.

## **Cannot Save Data to a Memory Device**

The following causes can be considered.

### ■ **The setting to save to a memory device has not been set.**

#### **Solutions**

Select **Settings > General Settings > Fax Settings > Receive Settings > Save/Forward Settings** on the home screen. Select the item you want to change, and then select **Save to Memory Device** from **Create a folder to save fax data**. You cannot use the external memory unless you set this setting.

### ■ The memory device is write-protected.

#### Solutions

Disable write protection on the memory device.

### ■ There is not enough free space on the memory device.

#### Solutions

Delete unnecessary data or insert another memory device.

## Operation Sounds Are Loud

### ■ Quiet Mode is disabled on the printer.

#### Solutions

If operations sounds are too loud, enable **Quiet Mode**. Enabling this feature may reduce printing speed.

- Control panel

Select  OFF on the home screen, and then enable **Quiet Mode**.

- Windows

Enable **Quiet Mode** on the printer driver's **Main** tab.

- Mac OS

Select **System Preferences** from the Apple menu > **Printers & Scanners** (or **Print & Scan**, **Print & Fax**), and then select the printer. Click **Options & Supplies** > **Options** (or **Driver**). Enable the **Quiet Mode** setting.

## The Date and Time Are Incorrect

### ■ Error occurred in power supply.

#### Solutions

After a power failure caused by a lightning strike or if the power is left off for a long time, the clock may show the wrong time. Set the date and the time correctly in **Settings** > **General Settings** > **Basic Settings** > **Date/Time Settings** on the control panel.

## The Root Certificate Needs to be Updated

### ■ The root certificate has expired.

#### Solutions

Run Web Config, select **Network Security** tab > **Root Certificate Update**, and then update the root certificate.

➔ [“Application for Configuring Printer Operations \(Web Config\)” on page 355](#)

## Cannot Perform Manual 2-sided Printing (Windows)

### ■ EPSON Status Monitor 3 is disabled.

#### Solutions

On the printer driver's **Maintenance** tab, click **Extended Settings**, and then select **Enable EPSON Status Monitor 3**.

However, manual 2-sided printing may not be available when the printer is accessed over a network or is used as a shared printer.

## The Print Settings Menu is Not Displayed (Mac OS)

### ■ The Epson Printer Driver has Not been Installed Correctly.

#### Solutions

If the **Print Settings** menu is not displayed on macOS Catalina (10.15) or later, macOS High Sierra (10.13), macOS Sierra (10.12), OS X El Capitan (10.11), OS X Yosemite (10.10), OS X Mavericks (10.9), the Epson printer driver has not been installed correctly. Enable it from the following menu.

Select **System Preferences** from the Apple menu > **Printers & Scanners** (or **Print & Scan**, **Print & Fax**), remove the printer, and then add the printer again.

macOS Mojave (10.14) cannot access **Print Settings** in applications made by Apple such as TextEdit.

## Forgot Your Password

### ■ You need help from service personnel.

#### Solutions

If you forget the administrator's password, contact Epson support.

## Copies are Made or Faxes are Sent Unintentionally

### ■ Foreign objects are touching the optical touch panel.

#### Solutions

Select **Settings** > **General Settings** > **Basic Settings** > **Wake from Sleep**, and then turn off **Touch LCD Screen to Wake**. The printer will not return from sleep mode (power saving) until you press the  button.

## Sender's Fax Number Not Displayed

### ■ The sender's fax number is not set to the sender's machine.

#### Solutions

The sender may not have set the fax number. Contact the sender.



## Sender's Fax Number Displayed on Received Faxes is Wrong

### ■ The sender's fax number set to the sender's machine is wrong.

#### Solutions

The sender may have set the fax number incorrectly. Contact the sender.

## Cannot Make Calls on the Connected Phone

Contact your printer administrator to check the external phone connection and printer settings. For printer administrators, see the following section to troubleshoot fax problems.

[“Cannot Make Calls on the Connected Telephone” on page 136](#)

## Answering Machine Cannot Answer Voice Calls

The following causes can be considered.

### ■ The number of rings for your answering machine is set to same or more than the printer's Rings to Answer setting.

#### Solutions

Set a number of rings for your answering machine lower than the printer's **Rings to Answer**.

To check the status of the fax settings, print a **Fax Settings List**. You can access the menu from the printer's control panel as described below.

**Fax** >  (More) > **Fax Report** > **Fax Settings List**

### ■ Answering Machine Cannot Answer Voice Calls After Trying the Solutions Above

#### Solutions

If you cannot solve the problem, contact your printer administrator. For printer administrators, see the following section to troubleshoot fax problems.

[“Answering Machine Cannot Answer Voice Calls” on page 136](#)

## A Lot of Junk Faxes Have Been Received

Contact your printer administrator to review the printer settings. For printer administrators, see the following section to troubleshoot fax problems.

[“A Lot of Junk Faxes Have Been Received” on page 136](#)

---

# Cannot Solve Problem

If you cannot solve the problem after trying all of the solutions, contact Epson support.

If you cannot solve printing or copying problems, see the following related information.

#### Related Information

➔ [“Cannot Solve Printing Problems” on page 342](#)

## Cannot Solve Printing Problems

If you cannot solve printing or copying problems, try the following solutions in order starting at the top until you solve the problem.

- Make sure you match the paper type loaded in the printer and the paper type set on the printer to the paper type settings in the printer driver.  
[“Paper Size and Type Settings” on page 140](#)
- Use a higher quality setting on the control panel or the printer driver.
- Reinstall the ink supply units already installed in the printer.  
Reinstalling the ink supply units may clear clogging in the print head nozzles and allow the ink to flow smoothly.  
However, because ink is consumed when the ink supply unit is reinstalled, a message asking you to replace the ink supply unit may be displayed depending on the amount of ink remaining.
- Use the **Print Quality Adjustment** feature.  
[“Adjusting the Print Quality” on page 262](#)
- Check that you are using genuine Epson ink supply units.  
Try to use genuine Epson ink supply units. The use of non-genuine ink supply units may cause print quality to decline.
- Check if the translucent film is smeared.  
If there are smears on the translucent film, carefully wipe off the smear.  
[“Cleaning the Translucent Film” on page 268](#)
- Make sure that there are no paper fragments left inside the printer.
- Check the paper.  
Check if the paper is curled or loaded with the printable side facing up.  
[“Paper Handling Precautions” on page 140](#)  
[“Available Paper and Capacities” on page 344](#)  
[“Unavailable Paper Types” on page 347](#)

If you cannot solve the problem by checking the solutions above, you may need to request repairs. Contact Epson support.

### Related Information

- ➔ [“Before Contacting Epson” on page 479](#)
- ➔ [“Contacting Epson Support” on page 479](#)

---

# Product Information

Paper Information. . . . .	344
Consumable Products Information. . . . .	347
Information on Optional Items. . . . .	349
Software Information. . . . .	349
Settings Menu List. . . . .	357
Product Specifications. . . . .	393
Font Specifications. . . . .	405
Regulatory Information. . . . .	411

# Paper Information

## Available Paper and Capacities

### Genuine Epson Paper

Epson recommends using genuine Epson paper to ensure high-quality printouts.

**Note:**

- Genuine Epson paper is not available when printing with the Epson universal printer driver.*
- The availability of paper varies by location. For the latest information on paper available in your area, contact Epson support.*
- See the following for information on available paper types for 2-sided printing.*  
[“Paper for 2-Sided Printing” on page 346](#)
- When printing on genuine Epson paper at a user defined size, only **Standard** or **Normal** print quality settings are available. Although some printer drivers allow you to select a better print quality, the printouts are printed using **Standard** or **Normal**.*

### Paper suitable for printing documents

Media Name	Size	Loading Capacity (Sheets)		
		Paper Cassette 1	Paper Cassette 2 to 4	Paper Tray
Epson Business Paper	A4	Up to the line indicated by the  symbol on the edge guide.		80
Epson Bright White Ink Jet Paper	A4	200	400	50

### Paper suitable for printing documents and photos

Media Name	Size	Loading Capacity (Sheets)		
		Paper Cassette 1	Paper Cassette 2 to 4	Paper Tray
Epson Photo Quality Ink Jet Paper	A4	80	80	70
Epson Matte Paper-Heavyweight	A4, 20x25 cm (8x10 in.)	50	50	20
Epson Double-Sided Matte Paper	A4	50	50	20

## Commercially Available Paper

**Note:**

- ❑ Half Letter, SP1 (210×270 mm), SP2 (210×149 mm), SP3 (100×170 mm), SP4 (130×182 mm), SP5 (192×132 mm), 16K (195×270 mm), and Indian-Legal sizes are not available when printing with the PostScript printer driver.
- ❑ See the following for information on available paper types for 2-sided printing.  
[“Paper for 2-Sided Printing” on page 346](#)

### Plain papers

Plain paper includes copy paper, preprinted paper (paper on which various forms are pre-printed such as slips or securities), letterhead, color paper, and recycled paper.

Size	Loading Capacity (Sheets)		
	Paper Cassette 1	Paper Cassette 2 to 4	Paper Tray
A4, A5, A6, B5, B6, Executive, Half Letter, 16K (195×270 mm), Indian-Legal, Letter, 8.5×13 in., Legal, SP1 (210 x 270 mm), SP2 (210×149 mm), SP3 (100×170mm), SP4 (130×182 mm)	Up to the line indicated by the ▼ symbol on the edge guide.		80
SP5 (192×132 mm)	Up to the line indicated by the ▼ symbol on the edge guide.	-	80
User Defined*(mm) 85 to 215.9×125 to 355.6	Up to the line indicated by the ▼ symbol on the edge guide.	-	-
User Defined*(mm) 100 to 215.9×148 to 355.6	-	Up to the line indicated by the ▼ symbol on the edge guide.	-
User Defined*(mm) 64 to 215.9×125 to 6000	-	-	80

\* Copying or printing from the control panel is not available.

### Thick paper (91 to 160 g/m<sup>2</sup>)

Size	Loading Capacity (Sheets)		
	Paper Cassette 1	Paper Cassette 2 to 4	Paper Tray
A4, A5, A6, B5, B6, Executive, Half Letter, 16K (195×270 mm), Indian-Legal, Letter, 8.5×13 in., Legal, SP1 (210 x 270 mm), SP2 (210×149 mm), SP3 (100×170mm), SP4 (130×182 mm)	90	250	30
SP5 (192×132 mm)	90	-	30

Size	Loading Capacity (Sheets)		
	Paper Cassette 1	Paper Cassette 2 to 4	Paper Tray
User Defined*(mm) 85 to 215.9×125 to 355.6	90	-	-
User Defined*(mm) 100 to 215.9×148 to 355.6	-	250	-
User Defined*(mm) 64 to 215.9×125 to 6000	-	-	30

\* Copying or printing from the control panel is not available.

### Thick paper (161 to 256 g/m<sup>2</sup>)

Size	Loading Capacity (Sheets)		
	Paper Cassette 1	Paper Cassette 2 to 4	Paper Tray
A4, A5, A6, B5, B6, Executive, Half Letter, 16K (195×270 mm), Indian-Legal, Letter, 8.5×13 in., Legal	-	-	30
User Defined*(mm) 64 to 215.9×125 to 6000	-	-	30

\* Copying or printing from the control panel is not available.

### Envelope

Media Name	Size	Loading Capacity (Envelopes)		
		Paper Cassette 1	Paper Cassette 2 to 4	Paper Tray
Envelope	Envelope #10, Envelope DL, Envelope C6	10	-	10
	Envelope C4	-	-	1

## Paper for 2-Sided Printing

### Genuine Epson Paper

- Epson Business Paper
- Epson Bright White Ink Jet Paper

### Related Information

➔ [“Available Paper and Capacities” on page 344](#)

### Commercially Available Paper

Only use the paper tray to print 2-sided print jobs manually.

- Plain paper, Copy paper, Preprinted paper, Letterhead, Color paper, Recycled paper<sup>\*1</sup>
- Thick paper (91 to 160 g/m<sup>2</sup>)<sup>\*1</sup>
- Thick paper (161 to 256 g/m<sup>2</sup>)<sup>\*2</sup>

\*1 A4, A5, B5, Executive, 16K, SP1, and user-defined size (148 to 215.9 x 210 to 297 mm) paper is supported for automatic 2-sided printing.

\*2 Manual 2-sided printing only.

### Related Information

➔ [“Available Paper and Capacities” on page 344](#)

### Unavailable Paper Types

Do not use the following papers. Using these types of paper causes paper jams and smears on the printout.

- Papers that are wavy
- Papers that are torn or cut
- Papers that are folded
- Papers that are damp
- Papers that are too thick or too thin
- Papers that have stickers

Do not use the following envelopes. Using these types of envelope causes paper jams and smears on the printout.

- Envelopes that are curled or folded
- Envelopes with adhesive surfaces on the flaps or window envelopes
- Envelopes that are too thin  
They may curl during printing.

---

## Consumable Products Information

### Ink Supply Unit Codes

Epson recommends the use of genuine Epson ink supply units. Epson cannot guarantee the quality or reliability of non-genuine ink. The use of non-genuine ink may cause damage that is not covered by Epson's warranties, and under certain circumstances, may cause erratic printer behavior. Information about non-genuine ink levels may not be displayed.

The following are the codes for genuine Epson ink supply units.

**Note:**

- Ink supply unit codes may vary by location. For the correct codes in your area, contact Epson support.
- Not all ink supply units are available in all regions.

**For Europe**

Size	Black
XL	T12F1
L	T12E1
S	T12D1

Visit the following website for information on Epson's ink supply unit yields.

<http://www.epson.eu/pageyield>

**For Australia and New Zealand**

Black
T12J1, T12H1

**For Asia**

Black
T11Y1, T11W1, T11V1

## Maintenance Box Code

Epson recommends the use of a genuine Epson maintenance box.

Maintenance box code: C9382



**Important:**

*Once a maintenance box has been installed in a printer it cannot be used with other printers.*

## Pickup Rollers Code

Epson recommends the use of genuine Epson pickup rollers.

The following are the codes.

**For all countries except for India, Bangladesh, Bhutan, Maldives, Sri Lanka and Nepal**

Paper cassette 1 (Paper Feed Roller for Cassette A): C12C938261

Paper cassette 2 to 4 (Paper Feed Roller for Cassette B): C12C938281



### For India, Bangladesh, Bhutan, Maldives, Sri Lanka and Nepal

Paper cassette 1 (Paper Feed Roller for Cassette A): C12C938271

Paper cassette 2 to 4 (Paper Feed Roller for Cassette B): C12C938291

---

## Information on Optional Items

### Optional Paper Cassette Unit Code

The following is the code for the optional paper cassette unit.

#### For all countries except for India, Bangladesh, Bhutan, Maldives, Sri Lanka and Nepal

Optional Single Cassette-P2 (C12C937901)

#### For India, Bangladesh, Bhutan, Maldives, Sri Lanka and Nepal

Optional Single Cassette-P2 (C12C937911)

---

## Software Information

This section introduces some of the applications available for your printer. For a list of supported software, see the following Epson website or launch Epson Software Updater for confirmation. You can download the latest applications.

<http://www.epson.com>

### Related Information

➔ [“Application for Updating Software and Firmware \(Epson Software Updater\)”](#) on page 356

## Application for Printing from a Computer (Windows Printer Driver)

The printer driver controls the printer according to the commands from an application. Making settings on the printer driver provides the best printing results. You can also check the status of the printer or keep it in top operating condition using the printer driver utility.

### Note:

*You can change the language of the printer driver. Select the language you want to use from the **Language** setting on the **Maintenance** tab.*

### Accessing the printer driver from applications

To make settings that apply only to the application you are using, access from that application.

Select **Print** or **Print Setup** from the **File** menu. Select your printer, and then click **Preferences** or **Properties**.

### Note:

*Operations differ depending on the application. See the application's help for details.*

### Accessing the printer driver from the control panel

To make settings that apply to all of the applications, access from the control panel.

#### Windows 11

Click on the start button, and then select **All apps > Windows Tools > Control Panel > View devices and printers in Hardware and Sound**. Right-click on your printer, or press and hold it and then select **Printing preferences**.

#### Windows 10/Windows Server 2022/Windows Server 2019/Windows Server 2016

Click on the start button, and then select **Windows System > Control Panel > View devices and printers in Hardware and Sound**. Right-click on your printer, or press and hold it and then select **Printing preferences**.

#### Windows 8.1/Windows 8/Windows Server 2012 R2/Windows Server 2012

Select **Desktop > Settings > Control Panel > View devices and printers in Hardware and Sound**. Right-click on your printer, or press and hold it and then select **Printing preferences**.

#### Windows 7/Windows Server 2008 R2

Click the start button, and select **Control Panel > View devices and printers in Hardware and Sound**. Right-click on your printer and select **Printing preferences**.

#### Windows Vista/Windows Server 2008

Click the start button, and select **Control Panel > Printers in Hardware and Sound**. Right-click on your printer and select **Printing preferences**.

#### Windows XP/Windows Server 2003 R2/Windows Server 2003

Click the start button, and select **Control Panel > Printers and Other Hardware > Printers and Faxes**. Right-click on your printer and select **Printing preferences**.

### Accessing the printer driver from the printer icon on the task bar

The printer icon on the desktop task bar is a shortcut icon allowing you to quickly access the printer driver.

If you click the printer icon and select **Printer Settings**, you can access the same printer settings window as the one displayed from the control panel. If you double-click this icon, you can check the status of the printer.

#### **Note:**

*If the printer icon is not displayed on the task bar, access the printer driver window, click **Monitoring Preferences** on the **Maintenance** tab, and then select **Register the shortcut icon to the taskbar**.*

### Starting the utility

Access the printer driver window. Click the **Maintenance** tab.

### Related Information

➔ [“Menu Options for the Printer Driver” on page 154](#)

## Application for Printing from a Computer (Mac OS Printer Driver)

The printer driver controls the printer according to the commands from an application. Making settings on the printer driver provides the best printing results. You can also check the status of the printer or keep it in top operating condition using the printer driver utility.

## Accessing the printer driver from applications

Click **Page Setup** or **Print** on the **File** menu of your application. If necessary, click **Show Details** (or ▼) to expand the print window.

### Note:

Depending on the application being used, **Page Setup** may not be displayed in the **File** menu, and the operations for displaying the print screen may differ. See the application's help for details.

## Starting the utility

Select **System Preferences** from the Apple menu > **Printers & Scanners** (or **Print & Scan**, **Print & Fax**), and then select the printer. Click **Options & Supplies** > **Utility** > **Open Printer Utility**.

## Related Information

➔ [“Menu Options for the Printer Driver” on page 180](#)

## Guide to Mac OS Printer Driver

### Epson Printer Utility

You can run a maintenance feature such as nozzle check and print head cleaning, and by starting **EPSON Status Monitor**, you can check printer status and error information.

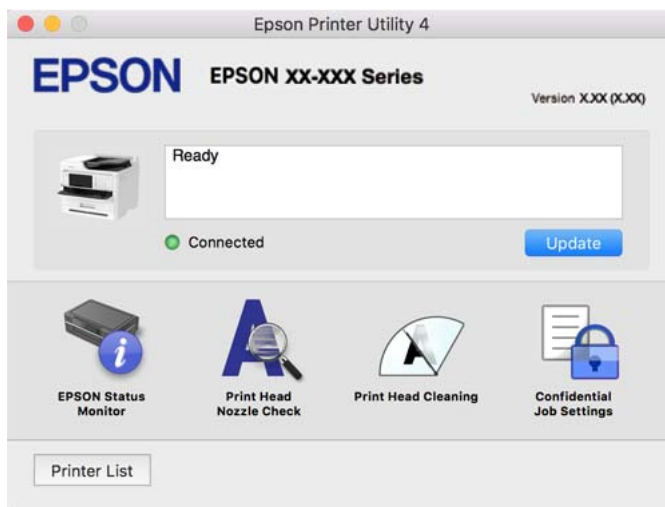

## Application that can print PostScript Fonts (Windows PostScript Printer Driver)

The PostScript printer driver allows the printer to receive and interpret print instructions in the page description language sent from the computer and print properly. This is suitable for printing from PostScript compliant applications used for DTP.

### Accessing the printer driver from applications

To make settings that apply only to the application you are using, access from that application.

Select **Print** or **Print Setup** from the **File** menu. Select your printer, and then click **Preferences** or **Properties**.

**Note:**

Operations differ depending on the application. See the application's help for details.

### Accessing the printer driver from the control panel

To make settings that apply to all of the applications, access from the control panel.

Windows 11

Click on the start button, and then select **All apps > Windows Tools > Control Panel > View devices and printers** in **Hardware and Sound**. Right-click on your printer, or press and hold it and then select **Printing preferences**.

Windows 10/Windows Server 2022/Windows Server 2019/Windows Server 2016

Click on the start button, and then select **Windows System > Control Panel > View devices and printers** in **Hardware and Sound**. Right-click on your printer, or press and hold it and then select **Printing preferences**

Windows 8.1/Windows 8/Windows Server 2012 R2/Windows Server 2012

Select **Desktop > Settings > Control Panel > View devices and printers** in **Hardware and Sound**. Right-click on your printer, or press and hold it and then select **Printing preferences**

Windows 7/Windows Server 2008 R2

Click the start button, and select **Control Panel > View devices and printers** in **Hardware and Sound**. Right-click on your printer and select **Printing preferences**.

Windows Vista/Windows Server 2008

Click the start button, and select **Control Panel > Printers** in **Hardware and Sound**. Right-click on your printer and select **Printing preferences**.

Windows XP/Windows Server 2003 R2/Windows Server 2003

Click the start button, and select **Control Panel > Printers and Other Hardware > Printers and Faxes**. Right-click on your printer and select **Printing preferences**.

### Accessing the printer driver from the printer icon on the task bar

The printer icon on the desktop task bar is a shortcut icon allowing you to quickly access the printer driver.

If you click the printer icon and select **Printer Settings**, you can access the same printer settings window as the one displayed from the control panel. If you double-click this icon, you can check the status of the printer.

### Related Information

➔ [“Menu Options for the PostScript Printer Driver” on page 175](#)

## Application that can print PostScript Fonts (Mac OS PostScript Printer Driver)

The PostScript printer driver allows the printer to receive and interpret print instructions in the page description language sent from the computer and print properly. This is suitable for printing from PostScript compliant applications used for DTP.

### Accessing the printer driver from applications

Click **Page Setup** or **Print** on the **File** menu of your application. If necessary, click **Show Details** (or ▼) to expand the print window.

**Note:**

Depending on the application being used, **Page Setup** may not be displayed in the **File** menu, and the operations for displaying the print screen may differ. See the application's help for details.

### Starting the utility

Select **System Preferences** from the Apple menu > **Printers & Scanners** (or **Print & Scan, Print & Fax**), and then select the printer. Click **Options & Supplies** > **Utility** > **Open Printer Utility**.

### Related Information

➔ [“Menu Options for the PostScript Printer Driver” on page 186](#)

## Application that can print PCL Language (PCL Printer Driver)

The PCL Printer Driver allows the printer to receive and interpret print instructions in the page description language sent from the computer and print properly. This is suitable for printing from general applications such as Microsoft Office.

**Note:**

Mac OS is not supported.

Connect the printer to the same network as the computer, and then follow the procedure below to install the printer driver.

1. Download the executable file of the driver from the Epson support website.  
<http://www.epson.eu/Support> (Europe only)  
<http://support.epson.net/>
2. Double-click the executable file.
3. Follow the on-screen instructions for the rest of the installation.

**Note:**

If your product comes with a software disc, you can also install using the disc. Access "Driver\PCL Universal".

## Application for Controlling the Scanner (Epson Scan 2)

Epson Scan 2 is a scanner driver that allows you to control the scanner. You can adjust the size, resolution, brightness, contrast, and quality of the scanned image. You can also start this application from a TWAIN-compliant scanning application. See the software help for details on using the features.

### Starting on Windows

**Note:**

For Windows Server operating systems, make sure the **Desktop Experience** feature is installed.

- Windows 11

Click the start button, and then select **All apps** > **EPSON** > **Epson Scan 2**.

- Windows 10/Windows Server 2022/Windows Server 2019/Windows Server 2016

Click the start button, and then select **EPSON** > **Epson Scan 2**.

- ❑ Windows 8.1/Windows 8/Windows Server 2012 R2/Windows Server 2012

Enter the application name in the search charm, and then select the displayed icon.

- ❑ Windows 7/Windows Server 2008 R2/Windows Server 2008

Click the start button, and then select **All Programs** or **Programs** > **EPSON** > **Epson Scan 2**.

### Starting on Mac OS

Select **Go** > **Applications** > **Epson Software** > **Epson Scan 2**.

## Application for Configuring Fax Operations and Sending Faxes (FAX Utility)

FAX Utility is an application that allows you to configure various settings for sending faxes from a computer. You can create or edit the contacts list to be used when sending a fax, configure to save received faxes in PDF format on the computer, and so on. See the application's help for details.

### Note:

- ❑ *Windows Server operating systems are not supported.*
- ❑ *Before installing the FAX Utility, make sure you have installed the printer driver for this printer; this does not include the PostScript printer driver and Epson universal printer driver.*
- ❑ *Make sure the FAX Utility has been installed. See "Starting on Windows" or "Starting on Mac OS" below to check if the application has been installed.*

### Starting on Windows

- ❑ Windows 11

Click the start button, and select **All Apps** > **Epson Software** > **FAX Utility**.

- ❑ Windows 10

Click the start button, and select **Epson Software** > **FAX Utility**.

- ❑ Windows 8.1/Windows 8

Enter the application name in the search charm, and then select the displayed icon.

- ❑ Windows 7/Windows Vista/Windows XP

Click the start button, and select **All Programs** (or **Programs**) > **Epson Software** > **FAX Utility**.

### Starting on Mac OS

Select **System Preferences** from the Apple menu > **Printers & Scanners** (or **Print & Scan, Print & Fax**), and then select the printer (FAX). Click **Options & Supplies** > **Utility** > **Open Printer Utility**.

### Related Information

- ➔ ["Sending a Fax from a Computer" on page 252](#)
- ➔ ["Receiving Faxes on a Computer" on page 257](#)

## Application for Sending Faxes (PC-FAX Driver)

PC-FAX driver is an application that allows you to send a document created on a separate application as a fax directly from the computer. PC-FAX driver is installed when you install FAX Utility. See the application's help for details.

**Note:**

- ❑ *Windows Server operating systems are not supported.*
- ❑ *Check if PC-FAX driver has been installed. See "Accessing from Windows" or "Accessing from Mac OS" below.*
- ❑ *The operation differs depending on the application you used to create the document. See the application's help for details.*

### Accessing from Windows

In the application, select **Print** or **Print Setup** from the **File** menu. Select your printer (FAX), and then click **Preferences** or **Properties**.

### Accessing from Mac OS

In the application, select **Print** from the **File** menu. Select your printer (FAX) as the **Printer** setting, and then select **Fax Settings** or **Recipient Settings** from the pop-up menu.

### Related Information

- ➔ ["Sending a Fax from a Computer" on page 252](#)

## Application for Configuring Printer Operations (Web Config)

Web Config is an application that runs in a web browser, such as Microsoft Edge and Safari, on a computer or smart device. You can confirm the printer status or change the network service and printer settings. To use the Web Config, connect the printer and the computer or device to the same network.

The following browsers are supported. Use the latest version.

Microsoft Edge, Internet Explorer, Firefox, Chrome, Safari

**Note:**

*You may be asked to enter the administrator password while operating Web Config. See the related information below for more details.*

### Related Information

- ➔ ["Default Value of the Administrator Password" on page 19](#)

## Running Web Config on a Web Browser

1. Check the printer's IP address.

Select the network icon on the printer's home screen, and then select the active connection method to confirm the printer's IP address.

**Note:**

*You can also check the IP address by printing the network connection report.*

2. Launch a Web browser from a computer or smart device, and then enter the printer's IP address.

Format:

IPv4: http://the printer's IP address/

IPv6: http://[the printer's IP address]/

Examples:

IPv4: http://192.168.100.201/

IPv6: http://[2001:db8::1000:1]/

**Note:**

*Using the smart device, you can also run Web Config from the product information screen of the Epson Smart Panel.*

Since the printer uses a self-signed certificate when accessing HTTPS, a warning is displayed on the browser when you start Web Config; this does not indicate a problem and can be safely ignored.

### Related Information

- ➔ [“Printing a Network Connection Report” on page 54](#)
- ➔ [“Printing Using Epson Smart Panel” on page 190](#)

## Application for Updating Software and Firmware (Epson Software Updater)

Epson Software Updater is an application that installs new software, and updates firmware over the Internet. If you want to check for update information regularly, you can set the interval for checking for updates in Epson Software Updater's Auto Update Settings.

**Note:**

*Windows Server operating systems are not supported.*

### Starting on Windows

- Windows 11

Click the start button, and then select **All apps > EPSON Software > Epson Software Updater**.

- Windows 10

Click the start button, and then select **EPSON Software > Epson Software Updater**.

- Windows 8.1/Windows 8

Enter the application name in the search charm, and then select the displayed icon.

- Windows 7/Windows Vista/Windows XP

Click the start button, and then select **All Programs (or Programs) > EPSON Software > Epson Software Updater**.

**Note:**

*You can also start Epson Software Updater by clicking the printer icon on the task bar on the desktop, and then selecting Software Update.*

### Starting on Mac OS

Select **Go > Applications > Epson Software > Epson Software Updater**.



### Related Information

➔ [“Installing the Applications Separately” on page 272](#)

## Software for Managing Devices on the Network (Epson Device Admin)

Epson Device Admin is a multifunctional application software that manages the device on the network.

The following functions are available.

- Monitor or manage up to 2,000 printers or scanners over the segment
- Make a detailed report, such as for the consumable or product status
- Update the firmware of the product
- Introduce the device to the network
- Apply the unified settings to multiple devices.

You can download Epson Device Admin from Epson support website. For more information, see the documentation or help of Epson Device Admin.

## Epson Authentication System (Epson Print Admin)

Epson Print Admin is an authentication system that allows you to manage Epson devices, as well as support cost reduction and operational efficiency thereby ensuring security. There are features listed below.

Contact your dealer for more information.

- Printing after authenticating the device.
- Limiting devices, functions, and time periods in which users can access the device.
- Storing records on all users and devices.
- Performing a scan in fewer steps by registering the scan settings in advance.
- Registering users by using the user information in Active Directory or LDAP server.

---

## Settings Menu List

Select **Settings** on the home screen of the printer to make various settings.

### General Settings

Select the menus on the control panel as described below.

**Settings > General Settings**

### Basic Settings

Select the menus on the control panel as described below.

## Settings > General Settings > Basic Settings

### LCD Brightness:

Adjust the brightness of the LCD screen.

### Sounds:

#### Mute:

Select **On** to mute sounds such as those emitted by **Button Press**.

#### Normal Mode:

Select the volume such as **Button Press**.

#### Fax:

Select the volume for the following fax functions.

#### Ring Tone:

Set the volume for when the printer receives a fax.

#### Receive Completion Notice:

Set the volume for when fax reception is complete.

#### Print Completion Notice:

Set the volume for when printing the received fax is complete.

#### Receiver:

Set the volume for the dial sound when the printer sends the fax.

#### Send Completion Notice:

Set the volume for when sending the fax is complete.

#### Button Press:

Set the volume when tapping the items on the screen on the control panel.

#### ADF Document Set:

Set the volume when originals are placed in the ADF.

#### Completion Notice:

Set the volume when operations are completed correctly.

#### Error Tone:

Set the volume when an error occurs.

#### Sound Type:

Set the type of sound.

#### Quiet Mode:

Select the volume such as **Button Press** in **Quiet Mode**.

Fax:

Select the volume for the following fax functions.

Ring Tone:

Set the volume for when the printer receives a fax.

Receive Completion Notice:

Set the volume for when fax reception is complete.

Print Completion Notice:

Set the volume for when printing the received fax is complete.

Receiver:

Set the volume for the dial sound when the printer sends the fax.

Send Completion Notice:

Set the volume for when sending the fax is complete.

Button Press:

Set the volume when tapping the items on the screen on the control panel.

ADF Document Set:

Set the volume when originals are placed in the ADF.

Completion Notice:

Set the volume when operations are completed correctly.

Error Tone:

Set the volume when an error occurs.

Sound Type:

Set the type of sound.

Sleep Timer: 

Adjust the time period to enter a sleep mode (energy saving mode) when the printer has not performed any operations. The LCD screen turns black when the setting time passes.

Wake from Sleep:

Touch LCD Screen to Wake:

Select **On** to return from sleep mode (energy saving mode) by tapping the touch panel. When this is off, you need to press a button on the control panel to wake the printer. Turning this feature off prevents any unintentional operations caused due to foreign objects touching the screen. You can also set a time period during which this feature is on.

Power Off Timer: 

Your product may have this feature or the **Power Off Settings** feature depending on the location of purchase.

Select this setting to turn the printer off automatically when it is not used for a specified period of time. You can adjust the time before power management is applied. Any increase will affect the product's energy efficiency. Please consider the environment before making any change.

Power Off Settings: 

Your product may have this feature or the **Power Off Timer** feature depending on the location of purchase.

Power Off If Inactive:

Select this setting to turn the printer off automatically if it is not used for a specified period of time. You can adjust the time before power management is applied. Any increase will affect the product's energy efficiency. Please consider the environment before making any change.

Power Off If Disconnected:

Select this setting to turn the printer off after a specified period of time when all ports including the LINE port are disconnected. This feature may not be available depending on your region.

See the following website for the specified period of time.

<https://www.epson.eu/energy-consumption>

Date/Time Settings: 

Date/Time:

Enter the current date and time.

Daylight Saving Time:

Select the summer time setting that applies to your area.

Time Difference:

Enter the time difference between your local time and UTC (Coordinated Universal Time).

Country/Region: 

Select the country or region in which you are using your printer. If you change the country or region, your fax settings return to their defaults and you must select them again.

Language: 

Select the language used on the LCD screen.

Start-up Screen: 

Specify the initial menu displayed on the LCD screen when the printer turns on and **Operation Time Out** is enable.

Edit Home: 

Change the layout of the icons on the LCD screen. You can also add, remove, and move icons.

Layout:

Select the layout of the home screen.

**Add Icon:**

Add an icon on the home screen.

**Remove Icon:**

Remove an icon from the home screen.

**Move Icon:**

Move an icon on the home screen.

**Restore Default Icon Display:**

Reset the home screen icons display to their defaults.

**Operation Time Out:** 

Select **On** to return to the initial screen when no operations have been performed for the specified time. When user restrictions have been applied and no operations are performed for the specified time, you are logged out and returned to the initial screen.

**Keyboard:**

Change the layout of the keyboard on the LCD screen.

**Default Screen(Job/Status):** 

Select the default information you want to display when you press the  button.

**Related Information**

➔ [“Entering Characters” on page 34](#)

## Printer Settings

Select the menus on the control panel as described below.

### Settings > General Settings > Printer Settings

**Paper Source Settings:**

**Paper Setting:**

Select the paper size and paper type you loaded in the paper source.

**Paper Tray Priority:**

Select **On** to give printing priority to paper loaded in the paper tray.

**A4/Letter Auto Switching:**

Select **On** to feed paper from the paper source set as A4 size when there is no paper source set as Letter, or feed from the paper source set as Letter size when there is no paper source set as A4.

#### Auto Select Settings:

If you enable **Paper Setting > Auto**, paper is automatically fed from a paper source that has the same settings as the paper settings for the current print job when paper runs out. In this menu, you can set automatic selection for every paper source for each function in copy, fax, or other. You cannot set everything to off.

This setting is disabled when you select a specific paper source in the paper settings for the print jobs. Depending on the paper type setting on the **Main** tab of the printer driver, paper may not be fed automatically.

#### Automatic Selection at Paper Out : For Copy:

Enable this to feed paper automatically from another paper source that has paper when paper runs out. This applies when copying. Paper is not feed automatically from a paper source that has not been selected in **Auto Select Settings** or that has different paper settings from the specified paper source.

This function is not applied in the following cases.

When copying using a paper source that has not been selected in **Auto Select Settings**.

#### Error Notice:

##### Paper Size Notice:

Select **On** to display an error message when the selected paper size does not match the loaded paper.

##### Paper Type Notice:

Select **On** to display an error message when the selected paper type does not match the loaded paper.

#### Paper Setup Auto Display:

Select **On** to display the **Paper Setting** screen when loading paper in the paper source. If you disable this feature, you cannot print from an iPhone, iPad, or iPod touch using AirPrint.

#### Printing Language:

##### USB:

Select the printing language for the USB interface.

##### Network:

Select the printing language for the network interface.

#### Universal Print Settings:

These print settings are applied when you print by an external device without using the printer driver. The offset settings are applied when you print using the printer driver.

##### Top Offset:

Adjust the top margin of the paper.

##### Left Offset:

Adjust the left margin of the paper.

**Top Offset in Back:**

Adjust the top margin for the back of the page when performing 2-sided printing.

**Left Offset in Back:**

Adjust the left margin for the back of the page when performing 2-sided printing.

**Check Paper Width:**

Select **On** to check the paper width before printing. This prevents printing beyond the edges of the paper when the paper size setting is incorrect, but this may lower the print speed.

**Skip Blank Page:**

Skips blank pages in the print data automatically to save paper.

**PDL Print Configuration:** 

Select the PDL Print Configuration options you want to use for PCL or PostScript printing.

**Common Settings:**

Select the common settings for PCL or PostScript printing.

**Paper Size:**

Select the default paper size for printing.

**Paper Type:**

Select the default paper type for printing.

**Orientation:**

Select the default orientation for printing.

**Quality:**

Select the print quality.

**Ink Save Mode:**

Select **On** to save ink by reducing the print density.

**Print Order:**

Select the print order, from the first page or the last page.

**Last Page on Top:**

Starts printing from the first page of a file.

**First Page on Top:**

Starts printing from the last page of a file.

**Number of Copies:**

Set the number of copies to print.

**Binding Margin:**

Select the binding position.

**Auto Paper Ejection:**

Select **On** to eject paper automatically when printing is stopped during a print job.

**2-Sided Printing:**

Select **On** to perform 2-sided printing.

**PCL Menu:**

Make settings for PCL printing.

**Font Source:**

**Resident:**

Select to use a font preinstalled on the printer.

**Download:**

Select to use a font you have downloaded.

**Font Number:**

Select the default font number for the default Font Source. The available number varies depending on the settings you made.

**Pitch:**

Set the default font pitch if the font is scalable and of fixed-pitch. You can select from 0.44 to 99.99 cpi (characters per inch), in 0.01 increments.

This item may not appear depending on the Font Source or Font Number settings.

**Height:**

Set the default font height if the font is scalable and proportional. You can select from 4.00 to 999.75 points, in 0.25 increments.

This item may not appear depending on the Font Source or Font Number settings.

**Symbol Set:**

Select the default symbol set. If the font that you selected in the Font Source and the Font Source setting is not available in the new symbol set setting, the Font Source and the Font Number settings are automatically replaced with the default value, IBM-US.

**Form:**

Set the number of lines for the selected paper size and orientation. This also causes a line spacing (VMI) change, and the new VMI value is stored in the printer. This means that later changes in the page size or orientation settings cause changes in the Form value based on the stored VMI.

**CR Function:**

Select the line feed command when printing with a driver from a specific operating system.

**LF Function:**

Select the line feed command when printing with a driver from a specific operating system.



#### Paper Source Assign:

Set the assignment for the paper source select command. When **4** is selected, the commands are set as compatible with the HP LaserJet 4. When **4K** is selected, the commands are set as compatible with the HP LaserJet 4000, 5000, and 8000. When **5S** is selected, the commands are set as compatible with the HP LaserJet 5S.

#### PS Menu:

Make settings for PS printing.

#### Error Sheet:

Select **On** to print a sheet showing the status when an error occurs during PostScript or PDF printing.

#### Binary:

Select **On** when printing data that contains binary images. The application may send the binary data even if the printer driver setting is set to ASCII, but you can print the data when this feature is enabled.

#### PDF Page Size:

Select the paper size when printing a PDF file.

#### Auto Error Solver:

Select an action to perform when a 2-sided printing error or a memory full error occurs.

On

Displays a warning and prints in single-sided mode when a 2-sided printing error occurs, or prints only what the printer could process when a memory full error occurs.

Off

Displays an error message and cancels printing.

#### Memory Device Interface:

Make settings to allow access to your memory device.

#### Memory Device:

Select **Enable** to allow the printer to access an inserted memory device. If **Disable** is selected, you cannot read, print data in the memory device, or save data to the memory device with the printer. This prevents confidential documents from being removed illegally.

#### File Sharing:

Select whether to give write access to the memory device from a USB-connected computer or a network-connected computer.

#### Thick Paper:

Select **On** to prevent ink from smearing on your printouts, however, this may lower the print speed.

#### Quiet Mode:

Select **On** to reduce noise during printing, however, this may lower the print speed. Depending on the paper type and print quality settings you selected, there may be no difference in the printer's noise

level. Select **On** to prioritize reducing operation noise. To prioritize printing speed, select **On (Low Level)**.

#### Ink Drying Time:

Select the ink drying time you want to use when performing 2-sided printing. The printer prints the other side after printing one side. If your printout is smeared, increase the time setting.

#### Bidirectional:

Select **On** to change the print direction; Prints while the print head moves to the left and to the right. If vertical or horizontal ruled lines on your printout look blurred or misaligned, disabling this feature may solve the problem; however, doing so may reduce print speed.

#### PC Connection via USB:

Select **Enable** to allow a computer to access the printer when connected by USB. When **Disable** is selected, printing and scanning that is not sent over a network connection is restricted.

#### USB I/F Timeout Setting:

Specify the length of time in seconds that must elapse before ending USB communication with a computer after the printer receives a print job from a PostScript printer driver or PCL printer driver. If the job ending is not clearly defined from a PostScript printer driver or PCL printer driver, it can cause endless USB communication. When this occurs, the printer ends communication after the specified time has elapsed. Enter 0 (zero) if you do not want to end communication.

### Related Information

- ➔ [“Loading Paper” on page 142](#)
- ➔ [“Printing Using Easy Settings” on page 152](#)
- ➔ [“Printing JPEG Files from a Memory Device” on page 192](#)
- ➔ [“Printing TIFF Files from a Memory Device” on page 193](#)

### Network Settings

Select the menus on the control panel as described below.

#### **Settings > General Settings > Network Settings**

##### Wi-Fi Setup:

Set up or change wireless network settings. Choose the connection method from following and then follow the instructions on the control panel.

##### Router:

###### Wi-Fi Setup Wizard:

Makes Wi-Fi settings by entering the SSID and password.

###### Push Button Setup(WPS):

Makes Wi-Fi settings by Push Button Setup(WPS).

#### Others:

- PIN Code Setup(WPS)  
Makes Wi-Fi settings by PIN Code Setup(WPS).
- Wi-Fi Auto Connect  
Makes Wi-Fi settings by using the Wi-Fi information on the computer or smart device.
- Disable Wi-Fi  
Disables Wi-Fi. Infrastructure connections will be disconnected.

#### Wi-Fi Direct:

##### (Menu) :

- Change Network Name  
Changes the Wi-Fi Direct SSID (network name).
- Change Password  
Changes the password for the Wi-Fi Direct connection.
- Change Frequency Range  
Select the frequency band for Wi-Fi Direct connection. Changing the frequency disconnects the connected device.  
The availability of these channels and use of the product outdoors over these channels varies by location.  
<http://support.epson.net/wifi5ghz/>
- Disable Wi-Fi Direct  
Disables the Wi-Fi Direct function.
- Restore Default Settings  
Restores the Wi-Fi Direct settings.

#### Other Methods:

- iOS  
Reads the QR code from your iPhone, iPad, or iPod touch to connect using Wi-Fi Direct.
- Other OS Devices  
Makes Wi-Fi Direct settings by entering the SSID and password.

#### Wired LAN Setup:

Set up or change a network connection that uses a LAN cable and router. When this is being used, Wi-Fi connections are disabled.

#### Network Status:

##### Wired LAN/Wi-Fi Status:

Displays the printer's network information.

##### Wi-Fi Direct Status:

Displays the Wi-Fi Direct setting information.

**Email Server Status:**

Displays the mail server setting information.

**Print Status Sheet:**

Prints a network status sheet.

The information for Ethernet, Wi-Fi, Wi-Fi Direct, and so on is printed on two or more pages.

**Connection Check:**

Checks the current network connection and prints a report. If there are any problems with the connection, see the report to solve the problem.

**Advanced:**

**Device Name:**

Changes the device name to any name within 2 to 53 characters.

**TCP/IP:**

Configures the IP settings, if the IP address is static.

For automatic configuration, use the IP address assigned by DHCP.

To set manually, switch to "Manual" and then enter the IP address you want to assign.

**Proxy Server:**

Set this if you are using a proxy server in your network environment and want to set it for the printer as well.

**Email Server:**

Set up the email server information and test connections when using the email forwarding feature.

**IPv6 Address:**

Sets whether or not to enable IPv6 addressing.

**MS Network Sharing:**

Set this when you want to use the file sharing feature.

**Link Speed & Duplex:**

Select an appropriate Ethernet speed and duplex setting. If you select a setting other than Auto, make sure the setting corresponds to the settings on the hub you are using.

**Redirect HTTP to HTTPS:**

Enables or disables redirecting from HTTP to HTTPS.

**Disable IPsec/IP Filtering:**

Disables the IPsec/IP filtering setting.

#### Disable IEEE802.1X:

Disables the IEEE802.1X setting.

#### iBeacon Transmission:

Select whether to enable or disable the iBeacon transmission function. When enabled, you can search for the printer from iBeacon-enabled devices.

### Related Information

- ➔ “Making Wi-Fi Settings by Entering the SSID and Password” on page 52
- ➔ “Making Wi-Fi Settings by Push Button Setup (WPS)” on page 53
- ➔ “Making Wi-Fi Settings by PIN Code Setup (WPS)” on page 54
- ➔ “Checking the Printer’s Network Connection Status (Network Connection Report)” on page 278

## Web Service Settings

Select the menus on the control panel as described below.

### Settings > General Settings > Web Service Settings

#### Epson Connect Services:

Displays whether the printer is registered and connected to Epson Connect.

You can register to the service by selecting **Register** and follow the instructions.

For usage guides, see the following portal website.

<https://www.epsonconnect.com/>

<http://www.epsonconnect.eu> (Europe only)

When you have registered, you can change the following settings.

#### Suspend/Resume:

Select whether to suspend or resume Epson Connect services.

#### Unregister:

Unregisters the printer from Epson Connect services.

## Fax Settings

Select the menus on the control panel as described below.

### Settings > General Settings > Fax Settings

#### Note:

- You can also access Fax Settings from Web Config. Click the **Fax** tab on the Web Config screen.
- When you use Web Config to display the **Fax Settings** menu, there may be slight differences in the user interface and in location compared to the printer’s control panel.

### Quick Operation Button

You can find the menu on the printer's control panel below.

#### Settings > General Settings > Fax Settings > Quick Operation Button

**Note:**

*You cannot display this menu on the Web Config screen.*

Quick Operation Button 1, Quick Operation Button 2, Quick Operation Button 3:

Registers up to three shortcuts allowing you to quickly access the menu you use often when sending faxes. The shortcuts are displayed on the following menu.

**Fax > Fax Settings** tab.

### Basic Settings

You can find the menu on the printer's control panel below.

#### Settings > General Settings > Fax Settings > Basic Settings

**Note:**

*On the Web Config screen, you can find the menu below.*

**Fax tab > Basic Settings**

#### Fax Speed:

Select the fax transmission speed. We recommend selecting **Slow(9,600bps)** when a communication error occurs frequently, when sending/receiving a fax to/from abroad, or when you are using an IP (VoIP) phone service.

#### ECM:

Automatically corrects errors in the fax transmission (Error Correction Mode), mostly caused by telephone line noise. If this is disabled, you cannot send documents in color.

#### Dial Tone Detection:

Detects a dial tone before starting to dial. If the printer is connected to a PBX (Private Branch Exchange) or digital phone line, the printer may fail to start dialing. In this situation, change the **Line Type** setting to **PBX**. If this does not work, disable this feature. However, disabling this feature may drop the first digit of a fax number and send the fax to the wrong number.

#### Dial Mode:

Select the type of phone system to which you have connected the printer. When set to **Pulse**, you can temporarily switch the dialing mode from pulse to tone by pressing \* ("T" is entered) while entering numbers on the fax top screen. This setting may not be displayed depending on your region or country.

#### Line Type:

Select the line type to which you have connected the printer.

#### PSTN:

Select **PSTN** when the printer is connected to a public switched telephone network.

**PBX:**

Select **PBX** when using the printer in an environment that uses extensions and requires an external access code, such as 0 and 9, to get an outside line. For an environment that uses a DSL modem or terminal adapter, setting to **PBX** is also recommended.

**Access Code:**

Select **Use**, and then register an external access code such as 0 or 9. Then, when sending a fax to an outside fax number, enter # (hash) instead of the real code. # (hash) must also be used in **Contacts** as an external access code. If an external access code such as 0 or 9 is set in a contact, you cannot send faxes to the contact. In this case, set **Access Code** to **Do Not Use**, otherwise you must change the code in **Contacts** to #.

**Header:**

Enter your sender name and fax number. These appear as a header on outgoing faxes.

**Your Phone Number:**

You can enter up to 20 characters using 0-9 + or space. For Web Config, you can enter up to 30 characters.

**Fax Header:**

You can register up to 21 sender names as necessary. You can enter up to 40 characters for each sender name. For Web Config, enter the header in Unicode (UTF-8).

**Receive Mode:**

Select the receive mode.

[“Receiving Incoming Faxes” on page 233](#)

**DRD:**

If you have subscribed to a distinctive ring service from your telephone company, select the ring pattern to be used for incoming faxes. The distinctive ring service, offered by many telephone companies (the service name differs by company), allows you to have several phone numbers on one phone line. Each number is assigned different ring pattern. You can use one number for voice calls and another for fax calls. Depending on the region, this option may be **On** or **Off**.

**Rings to Answer:**

Select the number of rings that must occur before the printer automatically receives a fax.

**Remote Receive:**

**Remote Receive:**

When you answer an incoming fax call on a phone connected to the printer, you can start receiving the fax by entering the code using the phone.

**Start Code:**

Set the start code of **Remote Receive**. Enter two characters using 0-9, \*, #.

**Rejection Fax:**

**Rejection Fax:**

Select options to reject receiving junk faxes.

Rejection Number List:

If the other party's phone number is in the rejection number list, set whether to reject the incoming faxes.

Fax Header Blank:

If the other party's phone number is blocked, set whether to reject receiving the faxes.

Unregistered Contacts:

If the other party's phone number is not in the contacts, set whether to reject receiving the faxes.

Edit Blocked Number list:

You can register up to 30 fax numbers to reject the faxes and calls. Enter up to 20 characters using 0-9, \*, #, or space.

Save/Forward File Format:

Save/Forward File Format:

Select the format that you want to use for saving or forwarding faxes from **PDF** or **TIFF**.

PDF Settings:

Selecting **PDF** in **Save/Forward File Format** enables the settings.

Document Open Password:

Password Setting:

Enables to set a document open password.

Password:

Set a document open password.

Permissions Password:

Password Setting

Enables to set a password for printing or editing in a PDF file.

Password

Set a permission password in **Password**.

Printing

Allows printing the PDF file.

Editing

Allows editing the PDF file.

Cloud Destination List:

When using Epson Connect, you can register up to five addresses to the cloud service that is being administered by Epson Connect. You can upload document data as a file when forwarding faxes by specifying the registered address as a destination.

You may not be able to use online services depending on the country and region.



## Related Information

- ➔ [“Making the Printer Ready to Send and Receive Faxes” on page 119](#)
- ➔ [“Settings for a PBX Phone System” on page 121](#)
- ➔ [“Making Settings for Blocking Junk Faxes” on page 131](#)

## Send Settings

You can find the menu on the printer's control panel below.

**Settings > General Settings > Fax Settings > Send Settings**

### Note:

*On the Web Config screen, you can find the menu below.*

*Fax tab > Send Settings*

### Quick memory send:

The quick memory send feature starts sending the fax when the printer finishes scanning the first page. If you do not enable this feature, the printer starts sending after saving all of the scanned images to memory. By using this feature, you can reduce the overall operation time as scanning and sending are performed in parallel.

### Batch Send:

When there are multiple faxes waiting to be sent to the same recipient, this groups them together to send them at once. Up to five documents (up to 200 pages in total) can be sent at one time. This helps you save on transmission costs by reducing the number of connection times.

### Save Failure Data:

#### Save Failure Data:

When documents fail to send, enable this to save them to the printer's memory. You can resend the documents from the **Job/Status**.

#### Set Storage Period:

Select **On** to delete documents that failed to be sent after the storage period has expired.

#### Storage Period:

Set a period of days within which the printer will store the document that failed to send.

### Wait Time for Next Original:

#### Wait Time for Next Original:

Enable this to start sending the fax after you scan a document by tapping , and then wait for the next original until the time specified has passed.

#### Time:

Set the time to wait for the next original.

#### Fax Preview Display Time:

##### Fax Preview Display Time:

Enable this to start sending the fax after the specified time has passed without performing any operations after displaying the preview screen.

##### Time:

Specify the time to preview the scanned document before sending it.

#### Allow Backup:

Selecting **Allowed** allows you to backup faxes sent with **Fax > Fax Settings > Backup**.

## Receive Settings

### Related Information

➔ [“Save/Forward Settings” on page 374](#)

## Save/Forward Settings

### Unconditional Save/Forward:

You can find the menu on the printer's control panel below.

**Settings > General Settings > Fax Settings > Receive Settings > Save/Forward Settings > Unconditional Save/Forward**

#### Note:

*On the Web Config screen, you can find the menu below.*

**Fax tab > Save/Forward Settings > Unconditional Save/Forward**

You can set saving and forwarding destinations to the Inbox, a computer, an external memory device, email addresses, shared folders, and other fax machines. You can use these features at the same time. If you disable all items in Unconditional Save/Forward, the printer is set to print received faxes.

#### Save to Inbox:

Saves received faxes to the printer's Inbox. Up to 200 documents can be saved. Note that saving 200 documents may not be possible depending on the usage conditions such as the file size of saved documents, and using of multiple fax saving features at a time.

Though the received faxes are not automatically printed, you can view them on the printer's screen and print only the ones you need. However, if you select **Yes and Print** in another item, such as **Save to Computer** in **Unconditional Save/Forward**, the received faxes are printed automatically.

#### Save to Computer:

Saves received faxes as PDF or TIFF files on a computer connected to the printer. You can only set this to **Yes** by using the FAX Utility (application). You cannot enable this from printer's control panel. Install the FAX Utility on the computer in advance. After setting this to **Yes**, you can change this to **Yes and Print** from the printer's control panel.

### Save to Memory Device:

Saves received faxes as PDF or TIFF files to an external memory device connected to the printer. Selecting **Yes and Print** prints received faxes while saving them to the memory device.

Received documents are saved in the printer's memory temporarily before the documents are saved in the memory device connected to the printer. Because a memory full error disables sending and receiving faxes, keep the memory device connected to the printer.

### Create a folder to save fax data:

Follow the on-screen message displayed, and create a folder in the memory device to save fax data.

### Forward:

Forwards received faxes to the following destinations.

- To another fax machine
- To shared folders on a network or to email addresses in PDF or TIFF format
- To your cloud accounts in PDF or JPEG format

Forwarded faxes are deleted from the printer. Selecting **Yes and Print** prints received faxes while forwarding them.

To forward to an email address or a shared folder on a network, first add the forwarding destination to the contacts list. To forward to an email address, configure the email server settings.

To forward to a cloud account, register the user, the printer, and cloud destination to **Fax to Cloud > Destination List** in **Epson Connect**, and add a forwarding destination to **Cloud Destination List** from the printer's control panel beforehand.

### Destination:

You can select forwarding destinations from the contacts list or the cloud destination list you added in advance.

If you have selected a shared folder on a network, an email address, or a cloud account as the forwarding destination, we recommend that you test if you can send an image to the destination.

Select **Scan > Email, Scan > Network Folder/FTP** from the printer's control panel, select the destination, and then start scanning.

If you have selected a cloud account, you can perform a test by forwarding an image that has been saved in a fax box to the destination. Select **Fax Box** from the printer's control panel.

Select  (Preview menu) > **Forward(Cloud)** for a fax box in which any scanned image has been saved, select the destination, and then start forwarding.

### Options When Forwarding Failed:

You can select whether to print the failed fax or save it to the Inbox.

When the Inbox is full, receiving faxes is disabled. You should delete the documents from the inbox once they have been checked. The number of documents that have failed to be forwarded is displayed on the  on the home screen, in addition to other unprocessed jobs.

### Email Notifications:

Sends an email notification when the process you select below is complete. You can use the features below at the same time.

**Recipient:**

Set the destination of the process completion notification.

**Notify on Receive:**

Sends a notification when receiving a fax is complete.

**Notify on Print:**

Sends a notification when printing a fax is complete.

**Notify on Save:**

Sends a notification when saving a fax to a memory device is complete.

**Notify on Forward:**

Sends a notification when forwarding a fax is complete.

**Conditional Save/Forward:**

You can find the menu on the printer's control panel below.

**Settings > General Settings > Fax Settings > Receive Settings > Save/Forward Settings > Conditional Save/Forward**

**Note:**

*On the Web Config screen, you can find the menu below.*

*Fax tab > Save/Forward Settings > Conditional Save/Forward*

You can set saving and/or forwarding destinations to the Inbox, confidential boxes, an external memory device, email addresses, shared folders, and another fax machine.

When multiple conditions (**Conditional Save/Forward**) are set, they are referenced in the order of the items, and the **Conditional Save/Forward** that matches first is executed.

To switch between enabling or disabling the conditions, tap anywhere on the set item except for  .

[“Making Saving Settings to Receive Faxes with Specific Conditions” on page 127](#)

[“Forwarding Settings to Receive Faxes with Specific Conditions” on page 129](#)

**Name (Required):**

Enter name of the condition.

**Condition(s):**

Select the conditions and make the settings.

**Sender Fax ID match:**

**Sender Fax ID match:**

When the ID of the sender, such as the fax number, matches, the received fax is saved and forwarded.

**ID:**

Enter the ID of the sender such as the fax number.

**Subaddress(SUB) perfect match:**

**Subaddress(SUB) perfect match:**

When the subaddress (SUB) matches perfectly, the received fax is saved and forwarded.

**Subaddress(SUB):**

Enter the subaddress (SUB) for the sender.

**Password(SID) perfect match:**

**Password(SID) perfect match:**

When the password (SID) matches perfectly, the received fax is saved and forwarded.

**Password(SID):**

Enter the password (SID) for the sender.

**Receiving Time:**

**Receiving Time:**

Saves and forwards a fax received during the specified period of time.

**Start Time:**

Specify the start time to allow saving and forwarding received faxes.

**End Time:**

Specify the end time to allow saving and forwarding received faxes.

**Save/Forward Destination:**

Select the destination to save and forward received documents that match the conditions. You can use the features below at the same time.

**Save to Fax Box:**

**Save to Fax Box:**

Saves received faxes in the printer's Inbox or confidential box.

You can save up to 200 documents in total. Note that saving 200 documents may not be possible depending on the usage conditions such as the file size of saved documents, and using of multiple fax saving features at a time.

**Inbox:**

Saves received faxes in the printer's Inbox.

**Confidential XX:**

Saves received faxes in the printer's confidential box.

### Save to Memory Device:

#### Save to Memory Device:

Saves received faxes as PDF or TIFF files to an external memory device connected to the printer.

Received documents are saved in the printer's memory temporarily before the documents are saved in the memory device connected to the printer. Because a memory full error disables sending and receiving faxes, keep the memory device connected to the printer.

#### Create a folder to save fax data:

Follow the on-screen message displayed, and create a folder in the memory device to save fax data.

### Forward:

#### Forward:

Forwards received faxes to one of the following destinations.

- To another fax machine
- To a shared folder on a network or to an email address in PDF or TIFF format
- To your cloud account in PDF or JPEG format

Forwarded faxes are deleted from the printer. Selecting **Yes and Print** prints received faxes while forwarding them.

To forward to an email address or a shared folder on a network, first add the forwarding destination to the contacts list. To forward to an email address, configure the email server settings.

To forward to a cloud account, register the user, the printer, and cloud destination to **Fax to Cloud > Destination List** in **Epson Connect**, and add a forwarding destination to **Cloud Destination List** from the printer's control panel beforehand.

#### Destination:

You can select a forwarding destination from the contacts list or the cloud destination list you added in advance.

If you have selected a shared folder on a network, an email address, or a cloud account as the forwarding destination, we recommend that you test if you can send an image to the destination.

Select **Scan > Email, Scan > Network Folder/FTP** from the printer's control panel, select the destination, and then start scanning.

If you have selected a cloud account, you can perform a test by forwarding an image that has been saved in a fax box to the destination. Select **Fax Box** from the printer's control panel. Select  (Preview menu) > **Forward(Cloud)** for a fax box in which any scanned image has been saved, select the destination, and then start forwarding.

#### Options When Forwarding Failed:

You can select whether to print the failed fax or save it to the Inbox.

**Print:**

Prints received faxes.

**Save/Forward File Format:**

You can set the file format when saving or forwarding received faxes.

**PDF Settings:**

Selecting **PDF** in **Save/Forward File Format** enables the settings.

**Document Open Password:**

Password Setting:

Enables to set a document open password.

Password:

Set a document open password.

**Permissions Password:**

Password Setting

Enables to set a password for printing or editing in a PDF file.

Password

Set a permission password in **Password**.

Printing

Allows printing the PDF file.

Editing

Allows editing the PDF file.

**Email Notifications:**

Sends an email notification when the process you select below is complete. You can use the features below at the same time.

**Recipient:**

Set the destination of the process completion notification.

**Notify on Receive:**

Sends a notification when receiving a fax is complete.

**Notify on Print:**

Sends a notification when printing a fax is complete.

**Notify on Save:**

Sends a notification when saving a fax to a memory device is complete.

**Notify on Forward:**

Sends a notification when forwarding a fax is complete.

**Transmission Report:**

Prints a transmission report automatically after you save or forward a received fax.

Selecting **Print on Error** prints a report only when you save or forward a received fax and an error occurs.

### Common Settings:

You can find the menu on the printer's control panel below.

**Settings > General Settings > Fax Settings > Receive Settings > Save/Forward Settings > Common Settings**

#### Note:

*On the Web Config screen, you can find the menu below.*

**Fax tab > Fax Box > Inbox**

**Fax tab > Save/Forward Settings > Common Settings**

#### Inbox settings:

##### Options when memory is full:

You can select the operation to print the received fax or refuse to receive it when the Inbox memory is full.

##### Inbox Password Settings:

Password protects the Inbox to restrict users from viewing received faxes. Select **Change** to change the password, and select **Reset** to cancel password protection. When changing or resetting the password, you need the current password.

You cannot set a password when **Options when memory is full** has been set to **Receive and print faxes**.

#### Email Subject to Forward:

You can specify a subject for the email when forwarding to an email address.

#### Box Document Delete Settings:

##### Auto Delete Received Faxes:

Selecting **On** automatically deletes received fax documents in the inbox after a certain period of time.

##### Period Until Deletion:

Set a period of days after which the printer will delete the document saved in the inbox.

##### Faxes To Be Deleted:

Select the documents that you want to delete from **Read**, **Unread** and **All**.

### Menu:

You can find  on the printer's control panel by accessing the following menus in order.

**Settings > General Settings > Fax Settings > Receive Settings > Save/Forward Settings > **

#### Note:

*You cannot print the list from the Web Config screen.*



Print Conditional Save/Forward list:

Prints the Conditional Save/Forward list.

## Print Settings

You can find the menu on the printer's control panel below.

**Settings > General Settings > Fax Settings > Receive Settings > Print Settings**

### Note:

*On the Web Config screen, you can find the menu below.*

**Fax tab > Print Settings**

Auto Reduction:

Prints received faxes with large-size documents reduced to fit on the paper in the paper source. Reducing may not always be possible depending on the received data. If this is turned off, large documents are printed at their original size on multiple sheets, or a blank second page may be ejected.

Split Page Settings:

Prints received faxes with the page split when the size of the received documents is larger than the size of the paper loaded in the printer. If the amount that exceeds the paper length is less than the value set in **Delete Print Data After Split > Threshold**, the excess is discarded. If the amount that exceeds the paper length is over the set value, the excess is printed on another paper.

Delete Print Data After Split:

Delete Print Data After Split:

Select the area of the document to delete when the amount that exceeds the paper length is less than the value set in **Threshold**.

Threshold:

If the amount that exceeds the paper length is less than or equal to this value, the excess is discarded and is not printed.

Overlap When Split:

Overlap When Split:

When this is set to **On** and the data is divided and printed because the amount exceeds the **Delete Print Data After Split > Threshold**, the divided data is printed using the overlapping length specified in **Overlapping Width**.

Overlapping Width:

Data that exceeds this value is printed over.

Acting Print:

Make print settings when the document size of the received fax is larger than the size of the paper loaded in the printer.

Selecting **On(Split to pages)** splits the document longitudinally to print the received document. Selecting **On (Reduce to Fit)** reduces to a 50 % minimum to print.

#### Auto Rotation:

Rotates faxes received as landscape-oriented A5 size documents so that they are printed on A5 size paper. This setting is applied when the paper size setting for at least one paper source used for printing faxes is set to A5.

By selecting **Off**, faxes received as landscape-oriented A5 size, which are the same width as A4 portrait documents, are assumed to be A4 size faxes and printed as such.

Check the paper source settings for printing faxes and paper size for the paper sources in the following menus in **Settings > General Settings > Printer Settings > Paper Source Settings**.

**Auto Select Settings**

**Paper Setting > Paper Size**

#### Add Reception Information:

Prints reception information on the received fax, even if the sender does not set the header information. The reception information includes the received date and time, sender's ID, reception ID (such as "#001"), and page number (such as "P1"). By collating the reception ID printed on the received fax, you can check the transmission log in the fax report and the fax job history. When **Split Page Settings** is enabled, the split page number is also included.

#### 2-Sided:

##### 2-Sided:

Prints multiple pages of received faxes on both sides of the paper.

##### Binding Margin:

Select the binding position.

#### Print Start Timing:

Select options to start printing the faxes to receive.

**All Pages Received:** Printing starts after receiving all of the pages. To start printing from the first page or last page depends on the setting of **Collation Stack** feature. See the explanation for **Collation Stack**.

**First Page Received:** Starts printing when the first page is received, and then prints in order as the pages are received. If the printer cannot start printing, such as when it is printing other jobs, the printer starts printing received pages as a batch when it is available.

#### Collation Stack:

Since the first page is printed last (output to the top), the printed documents are stacked in the correct page order. When the printer is running low on memory, this feature may not be available.

#### Print Suspend Time:

##### Print Suspend Time:

During the specified time period, the printer saves documents received in the printer's memory without printing them. This feature can be used for noise prevention at night or to prevent confidential documents from being disclosed while you are away. Before using this feature, make sure there is enough free memory. Even before the restarting time, you can check and print the received documents individually from **Job/Status** on the home screen.

Time to Stop:

Stops printing documents.

Time to Restart:

Restarts printing documents automatically.

Quiet Mode:

Reduces the noise the printer makes when printing faxes, however, print speed may be reduced.

## Report Settings

You can find the menu on the printer's control panel below.

### Settings > General Settings > Fax Settings > Report Settings

**Note:**

*On the Web Config screen, you can find the menu below.*

**Fax tab > Report Settings**

Forwarding Report:

Prints a report after forwarding a received fax document. Select **Print** to print every time a document is forwarded.

Backup Error Report:

Prints a report when a backup error occurs on forwarding the sent fax to **Backup Destination**. You can set the destination in **Fax > Fax Settings > Backup**. Note that the backup feature is available when:

- Sending a fax in monochrome
- Sending a fax using the **Send Fax Later** feature
- Sending a fax using the **Batch Send** feature
- Sending a fax using the **Store Fax Data** feature

Fax Log Auto Print:

Prints the fax log automatically. Select **On(Every 100)** to print a log every time 100 fax jobs are completed. Select **On(Time)** to print the log at a specified time. However, if the number of fax jobs exceeds 100, the log is printed before the specified time.

Reception Report:

Prints a reception report after you received a fax.

**Print on Error** prints a report only when an error occurs.

Attach Fax image to report:

Prints a **Transmission Report** with an image of the first page of the sent document. Select **On(Large Image)** to print the upper part of the page without reducing. Select **On(Small Image)** to print the entire page reducing it to fit onto the report.

Fax Log Layout:

Selecting **Combine Send and Receive** prints a mixture of sent and received results in the **Fax Log**.

Selecting **Separate Send and Receive** prints send and receive results separately in the **Fax Log**.

#### Report Format:

Selects a format for fax reports in **Fax** >  **(More)** > **Fax Report** other than **Protocol Trace**. Select **Detail** to print with error codes.

#### Fax Log Output Method:

##### Fax Log Output Method:

Select an output method for fax reports such as **Save to Memory Device**. When you select **Forward**, select **Destination** from the contacts.

##### Destination:

Specify a destination to forward fax reports.

##### Create a folder to save fax data:

Follow the on-screen message displayed, and create a folder in the memory device to save fax data.

## Security Settings

You can find the menu on the printer's control panel below.

### Settings > General Settings > Fax Settings > Security Settings

#### Note:

*On the Web Config screen, you can find the menu below.*

#### Fax tab > Security Settings

##### Direct Dialing Restrictions:

Selecting **On** disables manual entry of the recipient's fax numbers allowing the operator to select recipients only from the contacts list or sent history.

Selecting **Enter Twice** requires the operator to enter the fax number again when the number was manually entered.

Selecting **Off** enables manual entry of the recipient's fax numbers.

##### Broadcasting Restrictions:

Selecting **On** allows only one fax number to be entered as the Recipient.

##### Confirm Address List:

Selecting **On** displays a recipient confirmation screen before starting the transmission.

You can select the recipients from **All** or **Only for Broadcasting**.

##### Backup Data Auto Clear:

Backup copies of sent and received documents are usually temporarily stored in the printer's memory to prepare for an unexpected power failure due to an electricity failure or incorrect operations.

Selecting **On** automatically erases the backups when sending or receiving a document completes successfully and the backups become unnecessary.

#### Clear Backup Data:

Erases all backup copies temporarily stored in the printer's memory. Run this before you give the printer to someone else or dispose of it.

This menu is not displayed on the Web Config screen.

#### **Check Fax Connection**

You can find the menu on the printer's control panel below.

**Settings > General Settings > Fax Settings > Check Fax Connection**

**Note:**

*You cannot display this menu on the Web Config screen.*

Selecting **Check Fax Connection** checks that the printer is connected to the phone line and ready for fax transmission. You can print the check result on A4 size plain paper.

#### **Fax Setting Wizard**

You can find the menu on the printer's control panel below:

**Settings > General Settings > Fax Settings > Fax Setting Wizard**

**Note:**

*You cannot display this menu on the Web Config screen.*

Selecting **Fax Setting Wizard** makes basic fax settings. Follow the on-screen instructions.

#### **Related Information**

➔ [“Basic Settings” on page 370](#)

➔ [“Making the Printer Ready to Send and Receive Faxes” on page 119](#)

#### **Scan Settings**

Select the menus on the control panel as described below.

**Settings > General Settings > Scan Settings**

#### Confirm Recipient:

Check destination before scanning.

#### Document Capture Pro:

When scanning using the **Computer** menu on the control panel, set the operation mode and other settings to match the computer on which Document Capture Pro is installed.

#### Operation Mode:

Set the operation mode.

Select **Client Mode** if Document Capture Pro is installed on Windows or Mac OS.

Select **Server Mode** if Document Capture Pro is installed on a Windows Server.

Server Address:

Enter the server address if you select **Server Mode**.

Group Settings:

Enable group settings on the printer. Use this item when you have enabled group settings on Document Capture Pro.

When this is enabled, enter the group number in **Group**.

Email Server:

Set the email server settings for scanning **Email**.

Select **Server Settings** to specify the authentication method for the printer to access the mail server.

[“Mail Server Setting Items” on page 66](#)

You can check the connection to the mail server by selecting **Connection Check**.

## System Administration

By using this menu, you can maintain the product as a system administrator. It also allows you to restrict product features for individual users to suite your work or office style.

Select the menus on the control panel as described below.

### Settings > General Settings > System Administration

Contacts Manager:

Add/Edit/Delete:

Register and/or delete contacts for the Fax, Scan to Email, and Scan to Network Folder/FTP menus.

Frequent:

Register frequently used contacts to access them quickly. You can also change the order of the list.

Print Contacts:

Print your contact list.

View Options:

Change the way the contact list is displayed.

Search Options:

Change the method for searching contacts.

Periodic Cleaning:

Enable this setting to perform periodic head cleaning when a certain number of pages have been printed or the printer detects that head cleaning is necessary. Select anything other than **Off** to maintain premium print quality. Under the following conditions, perform **Print Head Nozzle Check** and **Print Head Cleaning** yourself.

Printout problems

- When **Off** is selected for **Periodic Cleaning**
- When printing at high quality, such as photos

**Off:**

Disables periodic head cleaning.

**After Printing:**

Performs periodic head cleaning when printing is complete.

**Schedule:**

Performs periodic head cleaning at the time you specified.

If the printer is turned off at the specified time, periodic head cleaning is performed when the printer is turned on.

**Power Consumption Display:**

Select **On** to display the estimated power consumption on the screen.

**Clear Internal Memory Data:**

This item is displayed on PCL or PostScript compatible printer.

**PDL Font, Macro, and Working Area:**

This item is displayed on PCL or PostScript compatible printer.

Delete the printer's internal memory data, such as a downloaded font and macro for PCL printing or a job of password printing.

**Delete All Internal Memory Jobs:**

Delete the printer's internal memory data, such as jobs with passwords.

**Security Settings:**

**Restrictions:**

Set whether or not functions in this menu can be used individually even when panel lock is enabled.

[“Items That Can Be Set Individually” on page 417](#)

**Access Control:**

**Access Control:**

Select **On** to restrict product features. This requires users to log into the product control panel with their user name and password before they can use control panel features.

**Accept Unknown User Jobs:**

You can select whether or not to allow jobs that do not have the necessary authentication information.

#### Admin Settings:

##### Admin Password:

Set, change, and clear an administrator password.

##### Lock Setting:

Select whether or not to lock the control panel using the password registered in **Admin Password**.

#### Password Encryption:

Select **On** to encrypt your password. If you turn off the power while the restart is in progress, data may be corrupted and the printer settings will be restored to their defaults. If this occurs, set the password information again.

#### Audit Log:

Select **On** to record an audit log.

#### Program Verification on Start Up:

Select **On** to verify the printer's program when starting up.

#### Customer Research:

If you agree to provide customer usage information, product usage information such as the number of prints will be provided to Seiko Epson Corporation.

The information collected is used to improve our products and services.

##### Provide usage data:

Displays whether or not you have agreed to provide your customer usage information.

##### Country/Region:

Displays the country or region where you are using the product if you have agreed to provide your customer usage information.

#### Restore Default Settings:

##### Network Settings:

Resets the network setting to the default.

##### Copy Settings:

Resets the copy settings to the default.

##### Scan Settings:

Resets the scan setting to the default.

##### Fax Settings:

Resets the fax setting to the default.

#### Clear All Data and Settings:

Clears all the personal information stored in the printer's memory and resets all settings to their defaults.



#### Firmware Update:

You can get firmware information such as your current version and information on available updates.

#### Update:

Updates the firmware manually.

#### Automatic Firmware Update:

##### Automatic Firmware Update:

Select **On** to update firmware automatically and set the day of the week/start time to update.

##### Day:

Select the day of the week when you want to update the firmware.

##### Time:

Set the time when you want to start to update the firmware.

#### Notification:

Select **On** to display the firmware update icon on the home screen.

#### Firmware Version:

Displays the firmware version.

## Print Counter

Select the menus on the control panel as described below.

### Settings > Print Counter

Displays the total number of prints including items such as the status sheet from the time you purchased the printer. If you select **Print Sheet**, the Usage History Sheet is printed.



You can also check the number of pages printed from a memory device or other functions on the Usage History Sheet

## Supply Status

Select the menu on the control panel as described below.

### Settings > Supply Status

Displays the approximate level of the ink and service life of the maintenance box.

When  is displayed, the ink is running low or the maintenance box is nearly full. When  is displayed, you need to replace the item as ink is expended or the maintenance box is full.

### Related Information

➔ [“It is Time to Replace Ink Supply Units” on page 331](#)

## Maintenance

Select the menus on the control panel as described below.

### Settings > Maintenance

#### Print Quality Adjustment:

Select this feature if there are any problems with your print outs. You can check for clogged nozzles and clean the print head if necessary, and then adjust some parameters to improve print quality.

#### Print Head Nozzle Check:

Select this feature to check if the print head nozzles are clogged. The printer prints a nozzle check pattern.

#### Print Head Cleaning:

Select this feature to clean clogged nozzles in the print head.

#### Print Head Alignment:

##### Ruled Line Alignment:

Select this feature to align vertical lines.

##### Horizontal Alignment:

Select this feature if horizontal banding appears at regular intervals in your printouts.

#### Paper Guide Cleaning:

Select this feature if there are ink stains on the internal rollers. The printer feeds paper to clean the internal rollers.

#### Pickup roller information:

Select this feature to check the pickup roller service life of the paper cassette. You can also reset the pickup roller counter.

### Related Information

➔ [“Checking and Cleaning the Print Head” on page 263](#)

## Language

Select the menus on the control panel as described below.

### Settings > Language

Select the language used on the LCD screen.

## Printer Status/Print

Select the menus on the control panel as described below.

### Settings > Printer Status/Print

Print Status Sheet:

Configuration Status Sheet:

Print information sheets showing the current printer status and settings.

Supply Status Sheet:

Print information sheets showing the status of consumables.

Usage History Sheet:

Print information sheets showing the usage history of the printer.

PS Font List:

Print a list of fonts that are available for a PostScript printer.

PCL Font List:

Print a list of fonts that are available for a PCL print.

Network:

Displays the current network settings. You can also print the status sheet.

## Contacts Manager

Select the menus on the control panel as described below.

### Settings > Contacts Manager

Add/Edit/Delete: 

Register and/or delete contacts for the Fax, Scan to Email, and Scan to Network Folder/FTP menus.

Frequent:

Register frequently used contacts to access them quickly. You can also change the order of the list.

Print Contacts: 

Print your contact list.

View Options:

Change the way the contact list is displayed.

Search Options:

Change the method for searching contacts.

## User Settings

Select the menus on the control panel as described below.

### Settings > User Settings

#### Scan to Network Folder/FTP:

You can change the default settings in the Scan to Network Folder/FTP menu.

[“Menu Options for Scanning” on page 213](#)

#### Scan to Email:

You can change the default settings in the Scan to Email menu.

[“Menu Options for Scanning” on page 213](#)

#### Scan to Memory Device:

You can change the default settings in the Scan to Memory Device menu.

[“Menu Options for Scanning” on page 213](#)

#### Scan to Cloud:

You can change the default settings in the Scan to Cloud menu.

[“Menu Options for Scanning” on page 213](#)

#### Copy Settings:

You can change the default settings in the copy menu.

[“Basic Menu Options for Copying” on page 203](#)

[“Advanced Menu Options for Copying” on page 205](#)

#### Fax:

You can change the default settings in the Fax menu.

[“Fax Settings” on page 239](#)

## Authentication Device Status

Select the menus on the control panel as described below.

### Settings > Authentication Device Status

Displays the status of the authentication device.

## Epson Open Platform Information

Select the menus on the control panel as described below.

### Settings > Epson Open Platform Information

Displays the status of the Epson Open Platform.

# Product Specifications

## Printer Specifications

Print Head Nozzle Placement		Black ink nozzles: 1600
Weight of Paper*	Plain Paper	64 to 90 g/m <sup>2</sup>
	Thick Paper	91 to 256 g/m <sup>2</sup>
	Envelopes	75 to 100 g/m <sup>2</sup>

\* Even when the paper thickness is within this range, the paper may not feed in the printer or the print quality may decline depending on the paper properties or quality.

## Printable Area

### Printable Area for Single Sheets

Print quality may decline in the shaded areas due to the printer's mechanism.

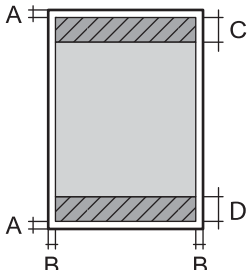
	A	3.0 mm (0.12 in.)
	B	3.0 mm (0.12 in.)
	C	47.0 mm (1.85 in.)
	D	45.0 mm (1.77 in.)

### Printable Area for Envelopes

Print quality may decline in the shaded areas due to the printer's mechanism.

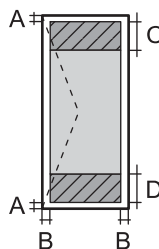
	A	3.0 mm (0.12 in.)
	B	3.0 mm (0.12 in.)
	C	18.0 mm (0.71 in.)
	D	47.0 mm (1.85 in.)

## Scanner Specifications

Scanner Type	Flatbed
Photoelectric Device	CIS

Effective Pixels	10200×14040 pixels (1200 dpi)
Maximum Document Size	216×297 mm (8.5×11.7 in.) A4, Letter
Scanning Resolution	1200 dpi (main scan) 2400 dpi (sub scan)
Output Resolution	50 to 9600 dpi in 1 dpi increments
Color Depth	Color <input type="checkbox"/> 48 bits per pixel internal (16 bits per pixel per color internal) <input type="checkbox"/> 24 bits per pixel external (8 bits per pixel per color external) Grayscale <input type="checkbox"/> 16 bits per pixel internal <input type="checkbox"/> 8 bits per pixel external
Light Source	LED

## ADF Specifications

ADF Type	Auto duplex scanning
Available Paper Sizes	A6, A5, A4, B5, Half-Letter, Executive, 16K, Indian-Legal, Letter, 8.5×13 in, Legal
Paper Type	Plain Paper, High quality plain paper, Recycled paper
Weight of Paper	64 to 95 g/m <sup>2</sup>
Loading Capacity	50 sheets or 5.5 mm

Even when the original meets the specifications for media that can be placed in the ADF, it may not feed from the ADF or the scan quality may decline depending on the paper properties or quality.

## Fax Specifications

Fax Type	Walk-up black and white and color fax capability (ITU-T Super Group 3)*1	
Supported Lines	Standard analogue telephone lines, PBX (Private Branch Exchange) telephone systems	
Resolution	Monochrome	<input type="checkbox"/> Standard: 8 pel/mm×3.85 line/mm (203 pel/in.×98 line/in.) <input type="checkbox"/> Fine: 8 pel/mm×7.7 line/mm (203 pel/in.×196 line/in.) <input type="checkbox"/> Super Fine: 8 pel/mm×15.4 line/mm (203 pel/in.×392 line/in.) <input type="checkbox"/> Ultra Fine: 16 pel/mm×15.4 line/mm (406 pel/in.×392 line/in.)
	Color	200×200 dpi
Speed	Up to 33.6 kbps	

Compression Method	Monochrome	MH/MR/MMR
	Color	JPEG
Communication Standards		G3, SuperG3
Sending Paper Size	Scanner Glass	Half Letter, A5, Letter, A4
	ADF	Half Letter, A5, Letter, A4
Recording Paper Size		A5, A4, B5, Letter, Legal
Transmission Speed* <sup>2</sup>		Approx. 3 sec. (A4 ITU-T chart No.1 Standard MMR 33.6 kbps)
Page Memory* <sup>3</sup>		Up to 550 pages (when an ITU-T No.1 chart is received in monochrome standard mode)
Contacts	Number of Contacts	Up to 200
	Number of Grouped Contacts	Up to 199
Redial* <sup>4</sup>		2 times (with 1 minute intervals)
Interface		RJ-11 Phone Line, RJ-11 Telephone set connection

\*1 Black-and-White only for receiving faxes.

\*2 The actual speed depends on the document, recipient's device, and the status of the phone line.

\*3 Retained even during a power outage.

\*4 The specifications may differ by country or region.

## Using Port for the Printer

The printer uses the following port. These ports should be allowed to become available by the network administrator as necessary.

### When the Sender (Client) is the Printer

Use	Destination (Server)	Protocol	Port Number	
File sending (When scan to network folder is used from the printer)	FTP/FTPS server	FTP/FTPS (TCP)	20	
			21	
	File server	SMB (TCP)	NetBIOS (UDP)	445
				137
				138
				139
	WebDAV server	Protocol HTTP (TCP)	Protocol HTTPS (TCP)	80
443				

Use	Destination (Server)	Protocol	Port Number
Email sending (When scan to mail is used from the printer)	SMTP server	SMTP (TCP)	25
		SMTP SSL/TLS (TCP)	465
		SMTP STARTTLS (TCP)	587
POP before SMTP connection (When scan to mail is used from the printer)	POP server	POP3 (TCP)	110
When Epson Connect is used	Epson Connect Server	HTTPS	443
		XMPP	5222
When Epson Remote Services is used	Epson Remote Services server	Protocol HTTPS (TCP)	443
		Protocol MQTT (TCP)	443
Collecting user information (Use the contacts from the printer)	LDAP server	LDAP (TCP)	389
		LDAP SSL/TLS (TCP)	636
		LDAP STARTTLS (TCP)	389
User authentication when sending email (When activating Epson Open Platform) User authentication when collecting user information (When using the contacts from the printer) User authentication when using the scan to network folder (SMB) from the printer	KDC server	Kerberos	88
Control WSD	Client computer	WSD (TCP)	5357
Search the computer when push scanning from Document Capture Pro	Client computer	Network Push Scan Discovery	2968

### When the Sender (Client) is the Client Computer

Use	Destination (Server)	Protocol	Port Number
File sending (When FTP printing is used from the printer)	Printer	FTP (TCP)	20
			21
Discover the printer from an application such as EpsonNet Config, printer driver, and scanner driver.	Printer	ENPC (UDP)	3289
Collect and set up the MIB information from an application such as EpsonNet Config, printer driver, and scanner driver.	Printer	SNMP (UDP)	161
Forwarding LPR data	Printer	LPR (TCP)	515
Forwarding RAW data	Printer	RAW (Port9100) (TCP)	9100
Forwarding AirPrint (IPP/IPPS printing) data	Printer	IPP/IPPS (TCP)	631



Use	Destination (Server)	Protocol	Port Number
Searching WSD printer	Printer	WS-Discovery (UDP)	3702
Forwarding the scan data from Document Capture Pro	Printer	Network Scan (TCP)	1865
Collecting the job information when push scanning from Document Capture Pro	Printer	Network Push Scan	2968
Web Config	Printer	HTTP (TCP)	80
		HTTPS (TCP)	443
Forwarding FaxOut Data	Printer	IPP FaxOut (TCP)	631
PC-FAX	Printer	HTTP (TCP)	80

## Interface Specifications

For Computer	Hi-Speed USB*
For External USB Device	Hi-Speed USB

\* USB 3.0 cables are not supported.

## Network Specifications

### Wi-Fi Specifications

See the following table for Wi-Fi specifications.

Countries or regions except for those listed below	<a href="#">"Table A" on page 397</a>
Ireland, United Kingdom, Austria, Germany, Liechtenstein, Switzerland, France, Belgium, Luxembourg, Netherlands, Italy, Portugal, Spain, Denmark, Finland, Norway, Sweden, Iceland, Croatia, Cyprus, Greece, North Macedonia, Serbia, Slovenia, Malta, Bosnia and Herzegovina, Kosovo, Montenegro, Albania, Bulgaria, Czech Republic, Estonia, Hungary, Latvia, Lithuania, Poland, Romania, Slovakia, Israel, Australia, New Zealand, China, Taiwan	<a href="#">"Table B" on page 398</a>
Turkey	Serial numbers starting with XC77: <a href="#">"Table A" on page 397</a> Serial numbers starting with XC76: <a href="#">"Table B" on page 398</a>

#### Table A

Standards	IEEE802.11b/g/n*1
-----------	-------------------

Frequency Range	2.4 GHz
Channels	1/2/3/4/5/6/7/8/9/10/11/12/13
Coordination Modes	Infrastructure, Wi-Fi Direct (Simple AP) <sup>*2*3</sup>
Security Protocols <sup>*4</sup>	WEP (64/128bit), WPA2-PSK (AES) <sup>*5</sup> , WPA3-SAE (AES), WPA2/WPA3-Enterprise

\*1 Only available for the HT20

\*2 Not supported for IEEE 802.11b

\*3 Infrastructure and Wi-Fi Direct modes or an Ethernet connection can be used simultaneously.

\*4 Wi-Fi Direct supports WPA2-PSK (AES) only.

\*5 Complies with WPA2 standards with support for WPA/WPA2 Personal.

**Table B**

Standards	IEEE802.11a/b/g/n <sup>*1</sup> /ac		
Frequency Ranges	IEEE802.11b/g/n: 2.4 GHz, IEEE802.11a/n/ac: 5 GHz		
Channels	Wi-Fi	2.4 GHz	1/2/3/4/5/6/7/8/9/10/11/12 <sup>*2</sup> /13 <sup>*2</sup>
		5 GHz <sup>*3</sup>	W52 (36/40/44/48), W53 (52/56/60/64), W56 (100/104/108/112/116/120/124/128/132/136/140/144), W58 (149/153/157/161/165)
	Wi-Fi Direct	2.4 GHz	1/2/3/4/5/6/7/8/9/10/11/12 <sup>*2</sup> /13 <sup>*2</sup>
		5 GHz <sup>*3</sup>	W52 (36/40/44/48) W58 (149/153/157/161/165)
Connection Modes	Infrastructure, Wi-Fi Direct (Simple AP) <sup>*4*5</sup>		
Security Protocols <sup>*6</sup>	WEP (64/128bit), WPA2-PSK (AES) <sup>*7</sup> , WPA3-SAE (AES), WPA2/WPA3-Enterprise		

\*1 Only available for the HT20

\*2 Not available in Taiwan

\*3 The availability of these channels and use of the product outdoors over these channels varies by location. For more information, see the following website.

<http://support.epson.net/wifi5ghz/>

\*4 Not supported for IEEE 802.11b

\*5 Infrastructure and Wi-Fi Direct modes or an Ethernet connection can be used simultaneously.

\*6 Wi-Fi Direct only supports WPA2-PSK (AES) .

\*7 Complies with WPA2 standards with support for WPA/WPA2 Personal.

## Ethernet Specifications

Standards	IEEE802.3i (10BASE-T)* <sup>1</sup> IEEE802.3u (100BASE-TX)* <sup>1</sup> IEEE802.3ab (1000BASE-T)* <sup>1</sup> IEEE802.3az (Energy Efficient Ethernet)* <sup>2</sup>
Communication Mode	Auto, 10 Mbps Full duplex, 10 Mbps Half duplex, 100 Mbps Full duplex, 100 Mbps Half duplex
Connector	RJ-45

\*1 Use a category 5e or higher STP (Shielded twisted pair) cable to prevent risk of radio interference.

\*2 The connected device should comply with IEEE802.3az standards.

## Network Functions and IPv4/IPv6

Functions		Supported	Remarks	
Network Printing	EpsonNet Print (Windows)	IPv4	✓	-
	Standard TCP/IP (Windows)	IPv4, IPv6	✓	-
	WSD Printing (Windows)	IPv4, IPv6	✓	Windows Vista or later
	Bonjour Printing (Mac OS)	IPv4, IPv6	✓	-
	IPP Printing (Windows, Mac OS)	IPv4, IPv6	✓	-
	FTP Printing	IPv4, IPv6	✓	-
	Epson Connect (Email Print, Remote Print)	IPv4	✓	-
	AirPrint (iOS, Mac OS)	IPv4, IPv6	✓	iOS 5 or later, OS X Mavericks (10.9.5) or later*
Network Scanning	Epson Scan 2	IPv4, IPv6	✓	-
	Document Capture Pro (Windows)	IPv4	✓	-
	Document Capture (Mac OS)			
	Document Capture Pro Server (Windows)	IPv4, IPv6	✓	-
	Epson Connect (Scan to Cloud)	IPv4	✓	-
	AirPrint (Scan)	IPv4, IPv6	✓	OS X Mavericks (10.9.5) or later*

Functions			Supported	Remarks
Fax	Send a fax	IPv4	✓	-
	Receive a fax	IPv4	✓	-
	AirPrint (Faxout)	IPv4, IPv6	✓	OS X Mavericks (10.9.5) or later*

\* We recommend using the latest version of iOS or Mac OS.

## Security Protocol

IEEE802.1X*	
IPsec/IP Filtering	
SSL/TLS	HTTPS Server/Client
	IPPS
SMTPS (STARTTLS, SSL/TLS)	
SNMPv3	

\* You need to use a device for connection that complies with IEEE802.1X.

## PostScript Level 3 Compatibility

The PostScript used on this printer is compatible with PostScript Level 3.

## Supported Third Party Services

Services		Supported	Remarks
AirPrint	Print	✓	iOS 5 or later/OS X Mavericks (10.9.5) or later*
	Scan	✓	OS X Mavericks (10.9.5) or later*
	Fax	✓	OS X Mavericks (10.9.5) or later*
Universal Print (Microsoft)		✓	Windows 10 2004 (20H1) or later

\* We recommend using the latest version of iOS or Mac OS.

## Memory Device Specifications

Devices	Maximum Capacities
USB Flash Drive	2 TB (formatted in FAT, FAT32, or exFAT.)

You cannot use the following devices:

- A device that requires a dedicated driver
- A device with security settings (password, encryption, and so on)

Epson cannot guarantee all operations of externally connected devices.

## Supported Data Specifications

File Format	JPEGs (*.JPG) with the Exif Version 2.31 standard taken by digital cameras DCF* <sup>1</sup> version 1.0 or 2.0* <sup>2</sup> compliant TIFF 6.0 compliant images as below <input type="checkbox"/> RGB full color images (not compressed) <input type="checkbox"/> Binary images (not compressed or CCITT encoded) PDF Version 1.7 compliant data file
Image Size	Horizontal: 80 to 10200 pixels Vertical: 80 to 10200 pixels
File Size	Less than 2 GB
Maximum Number of Files	JPEG: 9990* <sup>3</sup> TIFF: 999 PDF: 999

\*1 Design rule for Camera File system.

\*2 Photo data stored on digital cameras with a built-in memory is not supported.

\*3 Up to 999 files can be displayed at a time. (If the number of files exceeds 999, the files are displayed in groups.)

**Note:**

"x" is displayed on the LCD screen when the printer cannot recognize the image file. In this situation, if you select a multiple image layout, blank sections will be printed.

## Dimensions

### Dimensions\*<sup>1</sup>

Condition	Paper Cassette 1 Installed	Paper Cassette 1 and 2 Installed	Paper Cassette 1, 2, and 3 Installed	Paper Cassette 1, 2, 3 and 4 Installed

Storage	<input type="checkbox"/> Width: 425 mm (16.7 in.) <input type="checkbox"/> Depth: 535 mm (21.1 in.) <input type="checkbox"/> Height: 357 mm (14.1in.)	<input type="checkbox"/> Width: 425 mm (16.7 in.) <input type="checkbox"/> Depth: 535 mm (21.1 in.) <input type="checkbox"/> Height: 457 mm (18.0in.)	<input type="checkbox"/> Width: 425 mm (16.7 in.) <input type="checkbox"/> Depth: 535 mm (21.1 in.) <input type="checkbox"/> Height: 557 mm (21.9in.)	<input type="checkbox"/> Width: 425 mm (16.7 in.) <input type="checkbox"/> Depth: 535 mm (21.1 in.) <input type="checkbox"/> Height: 657 mm (25.9in.)
Printing	<input type="checkbox"/> Width: 425 mm (16.7 in.) <input type="checkbox"/> Depth: 578 mm (22.8 in.) <input type="checkbox"/> Height: 449 mm (17.7in.)	<input type="checkbox"/> Width: 425 mm (16.7 in.) <input type="checkbox"/> Depth: 578 mm (22.8 in.) <input type="checkbox"/> Height: 549 mm (21.6in.)	<input type="checkbox"/> Width: 425 mm (16.7 in.) <input type="checkbox"/> Depth: 578 mm (22.8 in.) <input type="checkbox"/> Height: 649 mm (25.6in.)	<input type="checkbox"/> Width: 425 mm (16.7 in.) <input type="checkbox"/> Depth: 578 mm (22.8 in.) <input type="checkbox"/> Height: 749 mm (29.5in.)

### Weight\*1\*2

Condition	Paper Cassette 1 Installed	Paper Cassette 1 and 2 Installed	Paper Cassette 1, 2, and 3 Installed	Paper Cassette 1, 2, 3 and 4 Installed
Weight	Approx. 19.0 kg (41.9 lb)	Approx. 23.5 kg (51.8 lb)	Approx. 28.0 kg (61.7 lb)	Approx. 32.5 kg (71.7 lb)

\*1 With the output tray.

\*2 Without the ink supply units and the power cord.

## Electrical Specifications

Power Supply Rating	AC 100-240 V	AC 220-240 V
Rated Frequency Range	50-60 Hz	50-60 Hz
Rated Current	1.0-0.6 A	0.5 A
Power Consumption (with USB Connection)	Standalone copying: Approx. 30.0 W (ISO/IEC24712) Ready mode: Approx. 15.4 W Sleep mode: Approx. 1.2 W Power off: Approx. 0.2 W	Standalone copying: Approx. 30.0 W (ISO/IEC24712) Ready mode: Approx. 15.4 W Sleep mode: Approx. 1.2 W Power off: Approx. 0.2 W

**Note:**

Check the label on the printer for its voltage.

For European users, see the following Website for details on power consumption.

<http://www.epson.eu/energy-consumption>

## Environmental Specifications

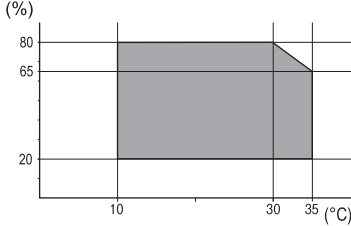
Operation	<p>Use the printer within the temperature (°C) and humidity (%) ranges shown in the graph, and in an environment without condensation.</p> 
Storage	<p>Temperature after initial ink charging: -15 to 40°C (5 to 104°F)*</p> <p>Temperature before initial ink charging: -20 to 40°C (-4 to 104°F)*</p> <p>Humidity: 5 to 85% RH (without condensation)</p>

\* You can store for one month at 40°C (104°F).

## Environmental Specifications for Ink Supply Units

Storage Temperature	-30 to 40 °C (-22 to 104 °F)*
Freezing Temperature	<p>Ink may freeze if it is stored below 0 °C (32 °F).</p> <p>Ink thaws and is usable after approximately 5 hours at 25 °C (77 °F).</p>

\* You can store for one month at 40 °C (104 °F).

## Installation Location and Space

To ensure safe use, place the printer in a location that meets the following conditions.

- A flat, stable surface that can support the weight of the printer
- Locations that do not block or cover the vents and openings in the printer
- Locations where you can load paper and remove paper easily
- Locations that meet the conditions in the "Environmental Specifications" in this manual

**!** *Important:*

*Do not place the printer in the following locations; otherwise a malfunction may occur.*

- Subject to direct sunlight*
- Subject to rapid changes in temperature and humidity*
- Subject to fire*
- Subject to volatile substances*
- Subject to shocks or vibrations*
- Near a television or a radio*
- Near excessive dirt or dust*
- Near water*
- Near air-conditioning or heating equipment*
- Near a humidifier*

Use a commercially available anti-static mat to prevent static generation in locations prone to generating static electricity.

Secure enough place to install and operate the printer correctly.

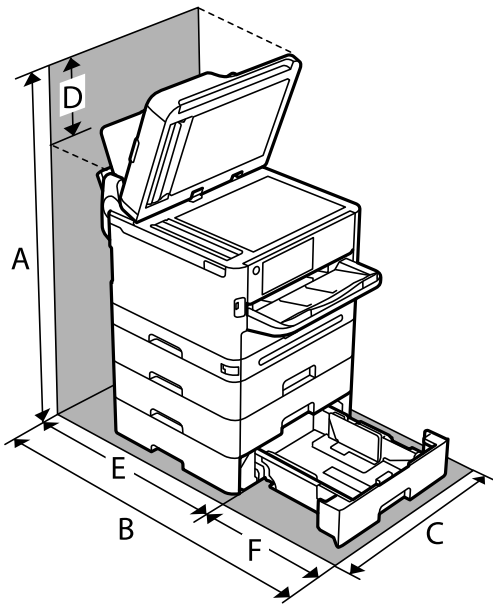

A	915.6mm
B	907.0mm
C	425.0mm
D	258.9mm
E	475.5mm
F	431.5mm



## System Requirements

Windows

Windows Vista, Windows 7, Windows 8/8.1, Windows 10, Windows 11 or later

Windows XP SP3 (32-bit)

Windows XP Professional x64 Edition SP2

Windows Server 2003 (SP2) or later

Mac OS

Mac OS X 10.9.5 or later, macOS 11 or later

**Note:**

*Mac OS may not support some applications and features.*

*The UNIX File System (UFS) for Mac OS is not supported.*

Chrome OS

Chrome OS 89 or later

**Note:**

*Only supports the standard OS features.*

---

## Font Specifications

### Available Fonts for PostScript

Font Name	Family	HP Equivalent
Nimbus Mono	Medium, Bold, Italic, Bold Italic	Courier
Letter Gothic	Medium, Bold, Italic	Letter Gothic
Nimbus Mono PS	Regular, Bold, Oblique, Bold Oblique	CourierPS
Nimbus Roman No4	Medium, Bold, Italic, Bold Italic	CG Times
URW Classico	Medium, Bold, Italic, Bold Italic	CG Omega
URW Coronet	-	Coronet
URW Clarendon Condensed	-	Clarendon Condensed
URW Classic Sans	Medium, Bold, Italic, Bold Italic	Univers
URW Classic Sans Condensed	Medium, Bold, Italic, Bold Italic	Univers Condensed
Antique Olive	Medium, Bold, Italic	Antique Olive
Garamond	Antiqua, Halbfett, Kursiv, Kursiv Halbfett	Garamond
Mauritius	-	Marigold
Algiers	Medium, Extra Bold	Albertus
NimbusSansNo2	Medium, Bold, Italic, Bold Italic	Arial

Font Name	Family	HP Equivalent
Nimbus Roman No9	Medium, Bold, Italic, Bold Italic	Times New Roman
Nimbus Sans	Medium, Bold, Oblique, Bold Oblique	Helvetica
Nimbus Sans Narrow	Medium, Bold, Oblique, Bold Oblique	Helvetica Narrow
Palladio	Roman, Bold, Italic, Bold Italic	Palatino
URW Gothic	Book, Demi, Book Oblique, Demi Oblique	ITC Avant Garde
URW Bookman	Light, Demi, Light Italic, Demi Italic	ITC Bookman
URW Century Schoolbook	Roman, Bold, Italic, Bold Italic	New Century Schoolbook
Nimbus Roman	Medium, Bold, Italic, Bold Italic	Times
URW Chancery Medium Italic	-	ITC Zapf Chancery Italic
Symbol	-	Symbol
URW Dingbats	-	Wingdings
Dingbats	-	ITC Zapf Dingbats
Standard Symbol	-	SymbolIPS

## Available Fonts for PCL (URW)

### Scalable Font

Font Name	Family	HP Equivalent	Symbol Set for PCL5
Nimbus Mono	Medium, Bold, Italic, Bold Italic	Courier	1
Letter Gothic	Medium, Bold, Italic	Letter Gothic	1
Nimbus Mono PS	Regular, Bold, Oblique, Bold Oblique	CourierPS	3
Nimbus Roman No4	Medium, Bold, Italic, Bold Italic	CG Times	2
URW Classico	Medium, Bold, Italic, Bold Italic	CG Omega	3
URW Coronet	-	Coronet	3
URW Clarendon Condensed	-	Clarendon Condensed	3
URW Classic Sans	Medium, Bold, Italic, Bold Italic	Univers	2
URW Classic Sans Condensed	Medium, Bold, Italic, Bold Italic	Univers Condensed	3
Antique Olive	Medium, Bold, Italic	Antique Olive	3
Garamond	Antiqua, Halbfett, Kursiv, Kursiv Halbfett	Garamond	3
Mauritius	-	Marigold	3

Font Name	Family	HP Equivalent	Symbol Set for PCL5
Algiers	Medium, Extra Bold	Albertus	3
NimbusSansNo2	Medium, Bold, Italic, Bold Italic	Arial	3
Nimbus Roman No9	Medium, Bold, Italic, Bold Italic	Times New	3
Nimbus Sans	Medium, Bold, Oblique, Bold Oblique	Helvetica	3
Nimbus Sans Narrow	Medium, Bold, Oblique, Bold Oblique	Helvetica Narrow	3
Palladio	Roman, Bold, Italic, Bold Italic	Palatino	3
URW Gothic	Book, Demi, Book Oblique, Demi Oblique	ITC Avant Garde Gothic	3
URW Bookman	Light, Demi, Light Italic, Demi Italic	ITC Bookman	3
URW Century Schoolbook	Roman, Bold, Italic, Bold Italic	New Century Schoolbook	3
Nimbus Roman	Medium, Bold, Italic, Bold Italic	Times	3
URW Chancery Medium Italic	-	ITC Zapf Chancery Medium Italic	3
Symbol	-	Symbol	4
URW Dingbats	-	Wingdings	5
Dingbats	-	ITC Zapf Dingbats	6
Standard Symbol	-	SymbolPS	4
URW David	Medium, Bold	HP David	7
URW Narkis	Medium, Bold	HP Narkis	7
URW Miryam	Medium, Bold, Italic	HP Miryam	7
URW Koufi	Medium, Bold	Koufi	8
URW Naskh	Medium, Bold	Naskh	8
URW Ryadh	Medium, Bold	Ryadh	8

### Bitmap Font

Font Name	Symbol Set
Line Printer	9

### OCR/Barcode Bitmap Font (for PCL5 only)

Font Name	Family	Symbol Set
OCR A	-	10

Font Name	Family	Symbol Set
OCR B	-	11
Code39	9.37cpi, 4.68cpi	12
EAN/UPC	Medium, Bold	13

**Note:**

Depending on the print density, or on the quality or color of the paper, OCR A, OCR B, Code39, and EAN/UPC fonts may not be readable. Print a sample and make sure the fonts can be read before printing large quantities.

## List of Symbol Sets

Your printer can access a variety of symbol sets. Many of these symbol sets differ only in the international characters specific to each language.

When you are considering which font to use, you should also consider which symbol set to combine with the font.

**Note:**

Since most software handles fonts and symbols automatically, you will probably never need to adjust the printer's settings. However, if you are writing your own printer control programs, or if you are using older software that cannot control fonts, refer to the following sections for symbol set details.

## List of Symbol Sets for PCL 5

Symbol Set Name	Attribute	Font Classification												
		1	2	3	4	5	6	7	8	9	10	11	12	13
Norweg1	0D	✓	✓	✓	-	-	-	-	-	-	-	-	-	-
Roman Extension	0E	-	-	-	-	-	-	-	-	✓	-	-	-	-
Italian	0I	✓	✓	✓	-	-	-	-	-	-	-	-	-	-
ECM94-1	0N	✓	✓	✓	-	-	-	-	-	✓	-	-	-	-
Swedis2	0S	✓	✓	✓	-	-	-	-	-	-	-	-	-	-
ANSI ASCII	0U	✓	✓	✓	-	-	-	✓	✓	-	-	-	-	-
UK	1E	✓	✓	✓	-	-	-	-	-	-	-	-	-	-
French2	1F	✓	✓	✓	-	-	-	-	-	-	-	-	-	-
German	1G	✓	✓	✓	-	-	-	-	-	-	-	-	-	-
Legal	1U	✓	✓	✓	-	-	-	-	-	✓	-	-	-	-
8859-2 ISO	2N	✓	✓	✓	-	-	-	-	-	✓	-	-	-	-
Spanish	2S	✓	✓	✓	-	-	-	-	-	-	-	-	-	-
ISO 8859/4 Latin 4	4N	✓	✓	✓	-	-	-	-	-	-	-	-	-	-

Symbol Set Name	Attribute	Font Classification												
		1	2	3	4	5	6	7	8	9	10	11	12	13
Roman-9	4U	✓	✓	✓	-	-	-	-	-	-	-	-	-	-
PsMath	5M	✓	✓	✓	-	-	-	✓	✓	-	-	-	-	-
8859-9 ISO	5N	✓	✓	✓	-	-	-	-	-	✓	-	-	-	-
WiTurkish	5T	✓	✓	✓	-	-	-	-	-	-	-	-	-	-
MsPublishin	6J	✓	✓	✓	-	-	-	-	-	-	-	-	-	-
VeMath	6M	✓	✓	✓	-	-	-	-	-	-	-	-	-	-
8859-10ISO	6N	✓	✓	✓	-	-	-	-	-	✓	-	-	-	-
DeskTop	7J	✓	✓	✓	-	-	-	-	-	-	-	-	-	-
Math-8	8M	✓	✓	✓	-	-	-	✓	✓	-	-	-	-	-
Roman-8	8U	✓	✓	✓	-	-	-	-	-	✓	-	-	-	-
WiE.Europe	9E	✓	✓	✓	-	-	-	-	-	-	-	-	-	-
Pc1004	9J	✓	✓	✓	-	-	-	-	-	-	-	-	-	-
8859-15ISO	9N	✓	✓	✓	-	-	-	-	-	✓	-	-	-	-
PcTk437	9T	✓	✓	✓	-	-	-	-	-	-	-	-	-	-
Windows	9U	✓	✓	✓	-	-	-	-	-	-	-	-	-	-
PsText	10J	✓	✓	✓	-	-	-	-	-	-	-	-	-	-
IBM-US	10U	✓	✓	✓	-	-	-	-	-	✓	-	-	-	-
IBM-DN	11U	✓	✓	✓	-	-	-	-	-	✓	-	-	-	-
McText	12J	✓	✓	✓	-	-	-	-	-	-	-	-	-	-
PcMultiling	12U	✓	✓	✓	-	-	-	-	-	✓	-	-	-	-
VeInternati	13J	✓	✓	✓	-	-	-	-	-	-	-	-	-	-
PcEur858	13U	✓	✓	✓	-	-	-	-	-	-	-	-	-	-
VeUS	14J	✓	✓	✓	-	-	-	-	-	-	-	-	-	-
PiFont	15U	✓	✓	✓	-	-	-	-	-	-	-	-	-	-
PcE.Europe	17U	✓	✓	✓	-	-	-	-	-	-	-	-	-	-
Unicode 3.0	18N	✓	✓	✓	-	-	-	✓	✓	-	-	-	-	-
WiBALT	19L	✓	✓	✓	-	-	-	-	-	-	-	-	-	-
WiAnsi	19U	✓	✓	✓	-	-	-	-	-	-	-	-	-	-
PcBlit775	26U	✓	✓	✓	-	-	-	-	-	-	-	-	-	-
Pc866Cyr	3R	✓	✓	-	-	-	-	-	-	-	-	-	-	-

Symbol Set Name	Attribute	Font Classification												
		1	2	3	4	5	6	7	8	9	10	11	12	13
Greek8	8G	✓	✓	-	-	-	-	-	-	-	-	-	-	-
WinGrk	9G	✓	✓	-	-	-	-	-	-	-	-	-	-	-
WinCyr	9R	✓	✓	-	-	-	-	-	-	-	-	-	-	-
Pc851Grk	10G	✓	✓	-	-	-	-	-	-	-	-	-	-	-
ISOCyr	10N	✓	✓	-	-	-	-	-	-	✓	-	-	-	-
Pc8Grk	12G	✓	✓	-	-	-	-	-	-	-	-	-	-	-
ISOGrk	12N	✓	✓	-	-	-	-	-	-	-	-	-	-	-
Pc866Ukr	14R	✓	✓	-	-	-	-	-	-	-	-	-	-	-
Hebrew7	0H	✓	-	-	-	-	-	✓	-	-	-	-	-	-
8859-8 ISO	7H	✓	-	-	-	-	-	✓	-	-	-	-	-	-
Hebrew8	8H	✓	-	-	-	-	-	✓	-	-	-	-	-	-
Pc862Heb	15H	✓	-	-	-	-	-	✓	-	-	-	-	-	-
PC-862, Hebrew	15Q	✓	-	-	-	-	-	✓	-	-	-	-	-	-
Arabic8	8V	-	-	-	-	-	-	-	✓	-	-	-	-	-
HPWARA	9V	-	-	-	-	-	-	-	✓	-	-	-	-	-
Pc864Ara	10V	-	-	-	-	-	-	-	✓	-	-	-	-	-
Symbol	19M	-	-	-	✓	-	-	-	-	-	-	-	-	-
Wingdings	579L	-	-	-	-	✓	-	-	-	-	-	-	-	-
ZapfDigrbats	14L	-	-	-	-	-	✓	-	-	-	-	-	-	-
OCR A	00	-	-	-	-	-	-	-	-	-	✓	-	-	-
OCR B	10	-	-	-	-	-	-	-	-	-	-	✓	-	-
OCR B Extension	3Q	-	-	-	-	-	-	-	-	-	-	✓	-	-
Code3-9	0Y	-	-	-	-	-	-	-	-	-	-	-	✓	-
EAN/UPC	8Y	-	-	-	-	-	-	-	-	-	-	-	-	✓

## Regulatory Information

### Standards and Approvals

#### Standards and Approvals for U.S. Model

Safety	UL60950-1 CAN/CSA-C22 No.60950-1-07
EMC	FCC Part 15 Subpart B Class B CAN ICES-3 (B)/NMB-3 (B)

This equipment contains the following wireless module.

Manufacturer: Seiko Epson Corporation

Type: J26H005

This product conforms to Part 15 of the FCC Rules and RSS-210 of the IC Rules. Epson cannot accept responsibility for any failure to satisfy the protection requirements resulting from a non-recommended modification of the product. Operation is subject to the following two conditions: (1) this device may not cause harmful interference, and (2) this device must accept any interference received, including interference that may cause undesired operation of the device.

To prevent radio interference to the licensed service, this device is intended to be operated indoors and away from windows to provide maximum shielding. Equipment (or its transmit antenna) that is installed outdoors is subject to licensing.

This equipment complies with FCC/IC radiation exposure limits set forth for an uncontrolled environment and meets the FCC radio frequency (RF) Exposure Guidelines in Supplement C to OET65 and RSS-102 of the IC radio frequency (RF) Exposure rules. This equipment should be installed and operated so that the radiator is kept at least 7.9 inches (20 cm) or more away from a person's body (excluding extremities: hands, wrists, feet and ankles).

#### Standards and Approvals for European Model

The following model is CE/UKCA marked and in compliance with the relevant statutory requirements.

The full text of the declaration of conformity is available at the following website:

<https://www.epson.eu/conformity>

C642E

Frequency Range	Maximum Radio-Frequency Power Transmitted
2400-2483.5 MHz	20 dBm (EIRP)
5150-5250 MHz	20 dBm (EIRP)
5250-5350 MHz	20 dBm (EIRP)
5470-5725 MHz	20 dBm (EIRP)



## Standards and Approvals for Australian Model

EMC	AS/NZS CISPR32 Class B
-----	------------------------

Epson hereby declares that the following equipment Models are in compliance with the essential requirements and other relevant provisions of AS/NZS4268:

C642E

Epson cannot accept responsibility for any failure to satisfy the protection requirements resulting from a non-recommended modification of the products.

## Standards and Approvals for New Zealand Model

### General Warning

The grant of a Telepermit for any item of terminal equipment indicates only that Telecom has accepted that the item complies with minimum conditions for connection to its network. It indicates no endorsement of the product by Telecom, nor does it provide any sort of warranty. Above all, it provides no assurance that any item will work correctly in all respects with another item of Telepermitted equipment of a different make or model, nor does it imply that any product is compatible with all of Telecom's network services.

Telepermitted equipment only may be connected to the EXT telephone port. This port is not specifically designed for 3-wire-connected equipment. 3-wire-connected equipment might not respond to incoming ringing when attached to this port.

### Important Notice

Under power failure conditions, this telephone may not operate. Please ensure that a separate telephone, not dependent on local power, is available for emergency use.

This equipment is not capable, under all operating conditions, of correct operation at the higher speeds for which it is designed. Telecom will accept no responsibility should difficulties arise in such circumstances.

This equipment shall not be set up to make automatic calls to the Telecom '111' Emergency Service.

## ZICTA Type Approval for Users in Zambia

See the following website to check the information for ZICTA Type Approval.

<https://support.epson.net/zicta/>

## German Blue Angel

See the following website to check whether or not this printer meets the standards for the German Blue Angel.

<http://www.epson.de/blauerengel>



## Restrictions on Copying

Observe the following restrictions to ensure the responsible and legal use of the printer.

Copying of the following items is prohibited by law:

- Bank bills, coins, government-issued marketable securities, government bond securities, and municipal securities
- Unused postage stamps, pre-stamped postcards, and other official postal items bearing valid postage
- Government-issued revenue stamps, and securities issued according to legal procedure

Exercise caution when copying the following items:

- Private marketable securities (stock certificates, negotiable notes, checks, etc.), monthly passes, concession tickets, etc.
- Passports, driver's licenses, warrants of fitness, road passes, food stamps, tickets, etc.

**Note:**

*Copying these items may also be prohibited by law.*

Responsible use of copyrighted materials:

Printers can be misused by improperly copying copyrighted materials. Unless acting on the advice of a knowledgeable attorney, be responsible and respectful by obtaining the permission of the copyright holder before copying published material.

---

# Administrator Information

Managing the Printer. . . . .	415
Product Security Settings. . . . .	433
Network Security Settings. . . . .	440
Using Epson Open Platform. . . . .	475
Epson Remote Services Information. . . . .	477

## Managing the Printer

### Checking Information for a Remote Printer

You can check the following information of the operating printer from **Status** by using Web Config.

Product Status

Check the status, cloud service, product number, MAC address, etc.

If you have registered information in **Administrator Name/Contact Information** on the **Device Management** tab, administrator information is displayed on the Status tab.

Network Status

Check the information of the network connection status, IP address, DNS server, etc.

Usage Status

Check the first day of printings, printed pages, printing count for each language, scanning count, etc.

Hardware Status

Check the status of each function of the printer.

Job History

Check the job log for print jobs, transmission jobs, and so on.

Panel Snapshot

Display a screen image snapshot that is displayed on the control panel of the device.

### Setting the Control Panel

Setup for the printer's control panel. You can set up as follows.

1. Enter the printer's IP address into a browser to access Web Config.

Enter the printer's IP address from a computer that is connected to the same network as the printer.

You can check the IP address of the printer from the following menu.

**Settings > General Settings > Network Settings > Network Status > Wired LAN/Wi-Fi Status**

2. Enter the administrator password to log in as an administrator.

3. Select in the following order.

**Device Management** tab > **Control Panel**

4. Set up the following items as necessary.

Language

Select the displayed language on the control panel.

Panel Lock

If you select **ON**, you cannot select items that require the administrator's authority. To select them, log in to the printer as the administrator. If the administrator password is not set, the panel lock is disabled.

Operation Timeout

If you select **ON**, when you log in as the access control user or administrator, you are automatically logged out and go to the initial screen if there is no activity for a certain period of time.

You can set between 10 seconds and 240 minutes by the second.

**Note:**

You can also set up from the printer's control panel.

Language : **Settings > General Settings > Basic Settings > Language**

Panel Lock : **Settings > General Settings > System Administration > Security Settings > Admin Settings > Lock Setting**

Operation Timeout : **Settings > General Settings > Basic Settings > Operation Time Out** (You can specify On or Off.)

5. Click **OK**.

**Related Information**

➔ [“Default Value of the Administrator Password” on page 19](#)

## Controlling the Panel Operation

If you enable the Lock Setting, you can lock the items related to the printer's system settings so that users cannot change them.

### Target Items for Lock Setting

#### Lock Setting items in the Settings menu

Locked menus are marked with . Lower level menus will also be locked.

#### Lock Setting items other than those in the Settings menu

Besides the **Settings** menu, Lock Setting is applied to the following items in the **Presets** menu.

Add New

Sort

 (Delete)

Add /Remove

**Related Information**

➔ [“Settings Menu List” on page 357](#)

➔ [“Items That Can Be Set Individually” on page 417](#)

## Operating Display and Function Setting Individually

For the some target items of the Lock Setting, you can individually set whether they are enabled or disabled.

You can set each user's availability as necessary, such as registering or changing the contacts, displaying job history, etc.

1. Select **Settings** on the printer's control panel.
2. Select **General Settings > System Administration > Security Settings > Restrictions**.
3. Select the item for the function that you want to change the setting of, and then set to **On** or **Off**.

### **Items That Can Be Set Individually**

The administrator can permit the items below to display and change settings individually.

Job Log Access:**Job/Status > Log**

Control the display of the status monitor's job history. Select **On** to permit the job history to display.

Access to Register/Delete Contacts:**Settings > Contacts Manager > Add/Edit/Delete**

Control the registering and changing of contacts. Select **On** to register or change the contacts.

Fax Recent Access:**Fax > Recipient > Recent**

Control the display of destination when sending and receiving a fax. Select **On** to display the destination.

Fax Transmission Log Access:**Fax >  > Transmission Log**

Control the display of the communication history of a fax. Select **On** to display the communication history.

Access to Fax Report:**Fax >  > Fax Report**

Control the printing of the fax report. Select **On** to permit printing.

Access to Print Save History of Scan to Network Folder/FTP:**Scan > Network Folder/FTP > Destination > Location**

Control the printing of save history for scan to network folder function. Select **On** to permit the printing.

Access to Recent of Scan to Email:**Scan > Email > Recipient**

Control the display of the history for the scan to mail function. Select **On** to display the history.

Access to Show Sent History of Scan to Email: **Scan > Email > Menu > Show Sent History**

Control the display of the history of email sending for the scan to mail function. Select **On** to display the history of email sending.

Access to Print Sent History of Scan to Email: **Scan > Email > Menu > Print Sent History**

Control the printing of the history of email sending for the scan to mail function. Select **On** to permit the printing.

Access to Language: **Settings > General Settings > Basic Settings > Language**

Control the changing of the language displayed on the control panel. Select **On** to change the languages.

Access to Thick Paper: **Settings > General Settings > Printer Settings > Thick Paper**

Control the changing of the settings of the Thick Paper function. Select **On** to change the settings.

Access to Quiet Mode: **Settings > General Settings > Printer Settings > Quiet Mode**

Control the changing of settings of the Quiet Mode function. Select **On** to change the settings.

Protection of Personal Data:

Control the display of the destination information on speed dial registration. Select **On** to display the destination as (\*\*\*)

### Related Information

- ➔ [“Operating Display and Function Setting Individually” on page 416](#)
- ➔ [“Settings Menu List” on page 357](#)

## Managing the Network Connection

You can check or configure the network connection.

### Checking or Configuring Basic Network Settings

1. Enter the printer's IP address into a browser to access Web Config.  
Enter the printer's IP address from a computer that is connected to the same network as the printer.  
You can check the IP address of the printer from the following menu.  
**Settings > General Settings > Network Settings > Network Status > Wired LAN/Wi-Fi Status**
2. Enter the administrator password to log in as an administrator.
3. Select in the following order.  
**Network tab > Basic**
4. Set each item.
5. Click **Next**.  
A confirmation message is displayed.
6. Click **OK**.  
The printer is updated.

### Related Information

- ➔ [“Default Value of the Administrator Password” on page 19](#)
- ➔ [“Network Setting Items” on page 418](#)

### Network Setting Items

Items	Setting value and Description
Device Name	Display the Device Name. To change the Device Name, enter the new Device Name in the text box.
Location	Enter the Location of the device.
Obtain IP Address	Select the IP Address setting method from Auto or Manual. If you select Manual, you will need to enter the IP address, subnet mask, and so on.
Set using BOOTP	You can specify whether or not to enable Set using BOOTP.
Set using Automatic Private IP Addressing (APIPA)	You can specify whether or not to enable Set using Automatic Private IP Addressing (APIPA).

Items	Setting value and Description
IP Address	Enter the IP Address. Enter in the format xxx.xxx.xxx.xxx. Enter a number from 0 to 255 for xxx. Make sure that the IP Address is unique and does not conflict with any other device on the network.
Subnet Mask	Enter the Subnet Mask. Enter in the format xxx.xxx.xxx.xxx. Enter a number from 0 to 255 for xxx.
Default Gateway	Enter the Default Gateway. Enter in the format xxx.xxx.xxx.xxx. Enter a number from 0 to 255 for xxx.
DNS Server Setting	Select the DNS Server Setting method from Auto or Manual. Manual is selected when Obtain IP Address is set to Manual.
Primary DNS Server	Enter the Primary DNS Server. Enter in the format xxx.xxx.xxx.xxx. Enter a number from 0 to 255 for xxx.
Secondary DNS Server	Enter the Secondary DNS Server. Enter in the format xxx.xxx.xxx.xxx. Enter a number from 0 to 255 for xxx.
DNS Host Name Setting	Select the DNS Host Name Setting method from Auto or Manual.
DNS Host Name	Display the current DNS Host Name.
DNS Domain Name Setting	Select the DNS Domain Name setting method from Auto or Manual.
DNS Domain Name	Enter the <b>DNS Domain Name</b> according to the following rules. <ul style="list-style-type: none"> <li><input type="checkbox"/> Enter between 2 and 249 characters using "A-Z", "a-z", "0-9", hyphen "-", and a period ".".</li> <li><input type="checkbox"/> "0-9", hyphen "-", and a period "." cannot be the first character.</li> <li><input type="checkbox"/> A hyphen "-", and a period "." cannot be the last character.</li> <li><input type="checkbox"/> Each label in the domain name must be between 1 and 63 characters and separated by a period.</li> </ul> The total number of characters of the host name and the domain name must not exceed 251.
Register the network interface address to DNS	You can specify whether or not to enable Register the network interface address to DNS. Enable if you want to register the host name and domain name with the DNS server through a DHCP server that supports dynamic DNS. If you select Enable, you will need to set the host name and domain name.
Proxy Server Setting	You can specify whether or not to use Proxy Server Setting. When this is selected, you need to configure the subsequent proxy server settings.
Proxy Server	Enter the address for the Proxy Server in IPv4 or FQDN format.
Proxy Server Port Number	Enter a number between 1 and 65535.
Proxy Server User Name	Enter the proxy server user name between 0 and 255 characters in ASCII (0x20-0x7E).
Proxy Server Password	Enter the proxy server password between 0 and 255 characters in ASCII (0x20-0x7E).

Items	Setting value and Description
IPv6 Setting	You can specify whether or not to enable IPv6 Setting.
IPv6 Privacy Extension	You can specify whether or not to enable IPv6 Privacy Extension.
IPv6 DHCP Server Setting	You can specify whether or not to enable IPv6 DHCP Server Setting.
IPv6 Address	<p>When using <b>IPv6 Address</b>, enter in the following format.</p> <ul style="list-style-type: none"> <li><input type="checkbox"/> xxxx: xxxx: xxxx: xxxx: xxxx: xxxx: xxxx: xxxx / prefix</li> <li><input type="checkbox"/> xxxx is a hexadecimal number from 1 to 4 digits, and the prefix is a decimal number from 1 to 128.</li> <li><input type="checkbox"/> If there are consecutive blocks where xxxx is all 0s, it can be omitted as :: (Only one place).</li> </ul>
IPv6 Address Default Gateway	<p>When assigning <b>IPv6 Address Default Gateway</b>, enter in the following format.</p> <p>Enter in the following format.</p> <ul style="list-style-type: none"> <li><input type="checkbox"/> xxxx: xxxx: xxxx: xxxx: xxxx: xxxx: xxxx: xxxx</li> <li><input type="checkbox"/> xxxx is a hexadecimal number from 1 to 4 digits.</li> <li><input type="checkbox"/> If there are consecutive blocks where xxxx is all 0s, it can be omitted as :: (Only one place).</li> </ul>
IPv6 Link-Local Address	Displays the valid IPv6 Link-Local Address.
IPv6 Stateful Address	Displays the valid IPv6 Stateful Address.
IPv6 Stateless Address 1	Displays the valid IPv6 Stateless Address 1.
IPv6 Stateless Address 2	Displays the valid IPv6 Stateless Address 2.
IPv6 Stateless Address 3	Displays the valid IPv6 Stateless Address 3.
IPv6 Primary DNS Server	<p>Enter the IPv6 primary DNS server in the following format.</p> <ul style="list-style-type: none"> <li><input type="checkbox"/> xxxx: xxxx: xxxx: xxxx: xxxx: xxxx: xxxx: xxxx</li> <li><input type="checkbox"/> xxxx is a hexadecimal number from 1 to 4 digits.</li> <li><input type="checkbox"/> If there are consecutive blocks where xxxx is all 0s, it can be omitted as :: (Only one place).</li> </ul>
IPv6 Secondary DNS Server	<p>When assigning IPv6 Secondary DNS Server, enter in the following format.</p> <ul style="list-style-type: none"> <li><input type="checkbox"/> xxxx: xxxx: xxxx: xxxx: xxxx: xxxx: xxxx: xxxx</li> <li><input type="checkbox"/> xxxx is a hexadecimal number from 1 to 4 digits.</li> <li><input type="checkbox"/> If there are consecutive blocks where xxxx is all 0s, it can be omitted as :: (Only one place).</li> </ul>
IEEE802.11k/v	<p>You can specify whether or not to enable IEEE802.11k/v.</p> <p>For models that support Wi-Fi, this item is displayed when the Wireless LAN Interface is installed.</p>
IEEE802.11r	<p>You can specify whether or not to enable IEEE802.11r.</p> <p>For models that support Wi-Fi, this item is displayed when the Wireless LAN Interface is installed.</p>



## Wi-Fi

You can check the Wi-Fi or Wi-Fi Direct connection status.

To display the Wi-Fi Direct status, click Wi-Fi Direct tab.

**Note:**

*For models that support Wi-Fi, this item is displayed when the Wireless LAN Interface is installed.*

Setup button

When the Setup button is clicked, the Wi-Fi setup (infrastructure mode) screen is displayed.

Disable Wi-Fi button

When the Disable Wi-Fi button is clicked, the Wi-Fi (infrastructure mode) function is disabled.

If you used to use Wi-Fi (wireless LAN) but no longer need to do so due to a change in connection mode and so on, by removing unnecessary Wi-Fi signals, you can also reduce the load on the printer's standby power usage.

**Note:**

*You can also set up from the printer's control panel.*

**Settings > General Settings > Network Settings**

## Configuring Wired LAN Settings

1. Enter the printer's IP address into a browser to access Web Config.

Enter the printer's IP address from a computer that is connected to the same network as the printer.

You can check the IP address of the printer from the following menu.

**Settings > General Settings > Network Settings > Network Status > Wired LAN/Wi-Fi Status**

2. Enter the administrator password to log in as an administrator.

3. Select in the following order.

**Network** tab > **Wired LAN**

4. Set each item.

Link Speed & Duplex

Select the communication mode from the list.

IEEE 802.3az

You can specify whether or not to enable IEEE 802.3az.

5. Click **Next**.

A confirmation message is displayed.

6. Click **OK**.

The printer is updated.

### Related Information

➔ [“Default Value of the Administrator Password” on page 19](#)

## Configuring Wi-Fi Direct Settings

You can check or configure the Wi-Fi Direct Settings.

**Note:**

*For models that support Wi-Fi, this item is displayed when the Wireless LAN Interface is installed.*

1. Enter the printer's IP address into a browser to access Web Config.  
Enter the printer's IP address from a computer that is connected to the same network as the printer.  
You can check the IP address of the printer from the following menu.

**Settings > General Settings > Network Settings > Network Status > Wired LAN/Wi-Fi Status**

2. Enter the administrator password to log in as an administrator.

3. Select in the following order.

**Network** tab > **Wi-Fi Direct**

4. Sets each item.

Wi-Fi Direct

You can specify whether or not to enable the Wi-Fi Direct.

SSID

You can change the SSID (Network Name), whether or not to enable

Password

When changing the Wi-Fi Direct password, enter a new password.

Frequency Range

Select the frequency range to be used in Wi-Fi Direct.

IP Address

Select the IP Address setting method from Auto or Manual.

5. Click **Next**.

A confirmation message is displayed.

**Note:**

*To reset the Wi-Fi Direct settings, click the Restore Default Settings button.*

6. Click **OK**.

The printer is updated.

### Related Information

➔ [“Default Value of the Administrator Password” on page 19](#)

## Configuring Email Notifications When Events Occur

You can configure email notifications so that an email is sent to the specified addresses when events such as printing stopping or printer errors occur. You can register up to five destinations and set the notification settings for each destination.

To use this function, you need to set up the mail server before setting up notifications. Set up the email server on the network to which you want to send the email.

1. Enter the printer's IP address into a browser to access Web Config.  
 Enter the printer's IP address from a computer that is connected to the same network as the printer.  
 You can check the IP address of the printer from the following menu.

**Settings > General Settings > Network Settings > Network Status > Wired LAN/Wi-Fi Status**

2. Enter the administrator password to log in as an administrator.
3. Select in the following order.

**Device Management** tab > **Email Notification**

4. Set the subject of email notification.  
 Select the contents displayed on the subject from the two pull-down menus.
  - The selected contents are displayed next to **Subject**.
  - The same contents cannot be set on left and right.
  - When the number of characters in **Location** exceeds 32 bytes, characters exceeding 32 bytes are omitted.
5. Enter the email address for sending the notification email.  
 Use A-Z a-z 0-9 ! # \$ % & ' \* + - . / = ? ^ \_ { | } ~ @, and enter between 1 and 255 characters.
6. Select the language for the email notifications.
7. Select the checkbox on the event for which you want to receive a notification.

The number of **Notification Settings** is linked to the destination number of **Email Address Settings**.

The screenshot shows three sections of the configuration page:

- Subject Setting:** Includes a text field for the subject, a note that the location may be abbreviated if too long, and two dropdown menus for selecting content.
- Email Address Settings:** A table with five rows (Address 1 to 5) and two columns. The first column is for the email address, and the second is for the language (all set to English).
- Notification Settings:** A table with eight rows of events and five columns for addresses. The 'Paper out' row has a blue checkmark in column 1.

If you want a notification sent to the email address set for number 1 in **Email Address Settings** when the printer is out of paper, select the checkbox column **1** in line **Paper out**.

8. Click **OK**.  
 Confirm that an email notification will be sent by causing an event.  
 Example : Print by specifying the Paper Source where paper is not set.

### Related Information

- ➔ [“Default Value of the Administrator Password” on page 19](#)
- ➔ [“Configuring a Mail Server” on page 65](#)

## Items for Email Notification

Items	Settings and Explanation
Ink supply unit(s) to be replaced	Notice when the ink is expended.
Ink low	Notice when the ink is nearing expended.
Maintenance box: end of service life	Notice when the maintenance box is full.
Maintenance box: nearing end	Notice when the maintenance box is nearing full.
Administrator password changed	Notice when administrator password has been changed.
Paper out	Notice when the paper-out error has occurred in the specified paper source..
Printing stopped	Notice when the printing is stopped due to paper jam or paper cassette not set.
Printer error	Notice when the printer error has occurred.
Scanner error	Notice when the scanner error has occurred.
Fax error	Notice when the fax error has occurred.
Wi-Fi failure	Notice when the error of the wireless LAN interface has occurred.
Built-in SD card failure	Notice when the error of the built-in SD card has occurred.
PDL board failure	Notice when the error of the PDL substrate has occurred.

### Related Information

- ➔ [“Configuring Email Notifications When Events Occur” on page 422](#)

## Power Saving Settings During Inactivity

You can set up the time to shift to the power saving mode or to turn the power off when the printer’s control panel is not operated for a certain period of time. Set the time depending on your usage environment.

1. Enter the printer's IP address into a browser to access Web Config.  
 Enter the printer's IP address from a computer that is connected to the same network as the printer.  
 You can check the IP address of the printer from the following menu.  
**Settings > General Settings > Network Settings > Network Status > Wired LAN/Wi-Fi Status**
2. Enter the administrator password to log in as an administrator.
3. Select in the following order.  
**Device Management tab > Power Saving**

4. Enter the administrator password to log in as an administrator.

5. Set up the following items as necessary.

Sleep Timer

Enter the time to switch power saving mode when inactivity occurs.

**Note:**

*You can also set up from the printer's control panel.*

**Settings > General Settings > Basic Settings > Sleep Timer**

Power Off Timer or Power Off If Inactive

Select a time to automatically turn off the printer after it has been inactive for a specific time. When you are using the fax features, select **None** or **Off**.

**Note:**

*You can also set up from the printer's control panel.*

**Settings > General Settings > Basic Settings > Power Off Timer or Power Off Settings**

Power Off If Disconnected

Select this setting to turn the printer off after a specified period of time when all ports including the LINE port are disconnected. This feature may not be available depending on your region.

See the following website for the specified period of time.

<https://www.epson.eu/energy-consumption>

**Note:**

*You can also set up from the printer's control panel.*

**Settings > General Settings > Basic Settings > Power Off Settings > Power Off If Disconnected**

6. Click **OK**.

## Related Information

➔ [“Default Value of the Administrator Password” on page 19](#)

## Setting the Sound

Make the sound settings when operating the control panel, printing, faxing and so on.

**Note:**

*You can also set up from the printer's control panel.*

**Settings > General Settings > Basic Settings > Sounds**

1. Enter the printer's IP address into a browser to access Web Config.

Enter the printer's IP address from a computer that is connected to the same network as the printer.

You can check the IP address of the printer from the following menu.

**Settings > General Settings > Network Settings > Network Status > Wired LAN/Wi-Fi Status**

2. Enter the administrator password to log in as an administrator.

3. Select in the following order.

**Device Management** tab > **Sound**

4. Set up the following items as necessary.

- Normal Mode

Set the sound when the printer is set to **Normal Mode**.

- Quiet Mode

Set the sound when the printer is set to **Quiet Mode**.

This is enabled when the one of the following items is enabled.

- Printer's control panel:

**Settings** > **General Settings** > **Printer Settings** > **Quiet Mode**

**Settings** > **General Settings** > **Fax Settings** > **Receive Settings** > **Print Settings** > **Quiet Mode**

- Web Config :

**Fax** tab > **Print Settings** > **Quiet Mode**

5. Click **OK**.

### Related Information

➔ [“Default Value of the Administrator Password” on page 19](#)

## Backing Up and Importing Printer Settings

You can export the setting value set from Web Config to the file. You can import the exported file to the printer by using Web Config. You can use it for backing up the contacts, setting values, replacing the printer, etc.

The exported file cannot be edited because it is exported as a binary file.

### Export the settings

Export the setting for the printer.

1. Enter the printer's IP address into a browser to access Web Config.

Enter the printer's IP address from a computer that is connected to the same network as the printer.

You can check the IP address of the printer from the following menu.

**Settings** > **General Settings** > **Network Settings** > **Network Status** > **Wired LAN/Wi-Fi Status**

2. Enter the administrator password to log in as an administrator.

3. Select in the following order.

**Device Management** tab > **Export and Import Setting Value** > **Export**

4. Select the settings that you want to export.

Select the settings you want to export. If you select the parent category, subcategories are also selected.

However, subcategories that cause errors by duplicating within the same network (such as IP addresses and so on) cannot be selected.

5. Enter a password to encrypt the exported file.

You need the password to import the file. Leave this blank if you do not want to encrypt the file.

6. Click **Export**.



**Important:**

*If you want to export the printer's network settings such as the device name and IPv6 address, select **Enable to select the individual settings of device** and select more items. Only use the selected values for the replacement printer.*

### Related Information

- ➔ [“Default Value of the Administrator Password” on page 19](#)

## Import the settings

Import the exported Web Config file to the printer.



**Important:**

*When importing values that include individual information such as a printer name or IP address, make sure the same IP address does not exist on the same network.*

1. Enter the printer's IP address into a browser to access Web Config.  
Enter the printer's IP address from a computer that is connected to the same network as the printer.  
You can check the IP address of the printer from the following menu.  
**Settings > General Settings > Network Settings > Network Status > Wired LAN/Wi-Fi Status**
2. Enter the administrator password to log in as an administrator.
3. Select in the following order.  
**Device Management tab > Export and Import Setting Value > Import**
4. Select the exported file, and then enter the encrypted password.
5. Click **Next**.
6. Select the settings that you want to import, and then click **Next**.
7. Click **OK**.

The settings are applied to the printer.

### Related Information

- ➔ [“Default Value of the Administrator Password” on page 19](#)

## Updating the Firmware

### Updating the Printer's Firmware using the Control Panel

If the printer can be connected to the Internet, you can update the printer's firmware using the control panel. You can also set the printer to regularly check for firmware updates and notify you if any are available.

1. Select **Settings** on the home screen.
2. Select **General Settings > System Administration > Firmware Update > Update**.

**Note:**

Select **Notification > On** to set the printer to regularly check for available firmware updates.

3. Check the message displayed on the screen and start searching for available updates.
4. If a message is displayed on the LCD screen informing you that a firmware update is available, follow the on-screen instructions to start the update.



**Important:**

- ❑ Do not turn off or unplug the printer until the update is complete; otherwise, the printer may malfunction.
- ❑ If the firmware update is not completed or is unsuccessful, the printer does not start up normally and "Recovery Mode" is displayed on the LCD screen the next time the printer is turned on. In this situation, you need to update the firmware again using a computer. Connect the printer to the computer with a USB cable. While "Recovery Mode" is displayed on the printer, you cannot update the firmware over a network connection. On the computer, access your local Epson website, and then download the latest printer firmware. See the instructions on the website for the next steps.

### Updating the Printer's Firmware Automatically

You can set the firmware to update automatically when the printer is connected to the Internet.

When the administrator lock is enabled, only the administrator can execute this function. Contact your printer administrator for assistance.

1. Select **Settings** on the printer's control panel.
2. Select **General Settings > System Administration > Firmware Update**.
3. Select **Automatic Firmware Update** to display the settings screen.
4. Select **Automatic Firmware Update** to enable this feature.

Select **Agree** on the confirmation screen to return to the settings screen.

5. Set the day and time for the update, and then select **OK**.

**Note:**

You can select multiple days of the week, but you cannot specify the time for each day of the week.

Setup is complete when the connection to the server is confirmed.



 **Important:**

- ❑ Do not turn off or unplug the printer until the update is complete. The next time you turn on the printer, "Recovery Mode" may be displayed on the LCD screen and you may not be able to operate the printer.
- ❑ If "Recovery Mode" is displayed, follow the steps below to update the firmware again.
  1. Connect the computer and the printer using a USB cable. (You cannot perform updates in recovery mode over a network.)
  2. Download the latest firmware from the Epson website and start updating. For details, see "Update method" on the download page.

**Note:**

You can set to update the firmware automatically from Web Config. Select the **Device Management** tab > **Automatic Firmware Update**, enable the settings, and then set the day of the week and time.

## Updating Firmware Using Web Config

When the printer can connect to the Internet, you can update the firmware from Web Config.

1. Enter the printer's IP address into a browser to access Web Config.

Enter the printer's IP address from a computer that is connected to the same network as the printer.

You can check the IP address of the printer from the following menu.

**Settings > General Settings > Network Settings > Network Status > Wired LAN/Wi-Fi Status**
2. Enter the administrator password to log in as an administrator.
3. Select in the following order.

**Device Management** tab > **Firmware Update**
4. Click **Start**, and then follow the on-screen instructions.

The firmware confirmation starts, and the firmware information is displayed if the updated firmware exists.

**Note:**

You can also update the firmware using Epson Device Admin. You can visually confirm the firmware information on the device list. It is useful when you want to update multiple devices' firmware. See the Epson Device Admin guide or help for more details.

## Updating Firmware without Connecting to the Internet

You can download the device's firmware from Epson website on the computer, and then connect the device and the computer by USB cable to update the firmware. If you cannot update over the network, try this method.

1. Access Epson website and download the firmware.
2. Connect the computer that contains the downloaded firmware to the printer by USB cable.
3. Double-click the downloaded .exe file.

Epson Firmware Updater starts.
4. Follow the on-screen instructions.

## Synchronizing the Date and Time with Time Server

When synchronizing with the time server (NTP server), you can synchronize the time of the printer and the computer on the network. The time server may be operated within the organization or published on the Internet.

When using the CA certificate or Kerberos authentication, time-related trouble can be prevented by synchronizing with the time server.

1. Enter the printer's IP address into a browser to access Web Config.

Enter the printer's IP address from a computer that is connected to the same network as the printer.

You can check the IP address of the printer from the following menu.

**Settings > General Settings > Network Settings > Network Status > Wired LAN/Wi-Fi Status**

2. Enter the administrator password to log in as an administrator.

3. Select in the following order.

**Device Management** tab > **Date and Time** > **Time Server**.

4. Select **Use** for **Use Time Server**.

5. Enter the time server address for **Time Server Address**.

You can use IPv4, IPv6 or FQDN format. Enter 252 characters or less. If you do not specify this, leave it blank.

6. Enter **Update Interval (min)**.

You can set up to 10,080 minutes by the minute.

7. Click **OK**.

**Note:**

You can confirm the connection status with the time server on **Time Server Status**.

### Related Information

➔ [“Default Value of the Administrator Password” on page 19](#)

## Clearing Internal Memory Data

You can delete the printer's internal memory data, such as downloaded fonts and macros for PCL printing, or jobs for password printing.

**Note:**

You can also set up from the printer's control panel.

**Settings > General Settings > System Administration > Clear Internal Memory Data**

1. Enter the printer's IP address into a browser to access Web Config.

Enter the printer's IP address from a computer that is connected to the same network as the printer.

You can check the IP address of the printer from the following menu.

**Settings > General Settings > Network Settings > Network Status > Wired LAN/Wi-Fi Status**

2. Enter the administrator password to log in as an administrator.

3. Select in the following order.  
**Device Management** tab > **Clear Internal Memory Data**
4. Click **Delete** for **PDL Font, Macro, and Working Area**.

## Managing your Contacts

You can make settings for viewing and searching the contact list.

1. Enter the printer's IP address into a browser to access Web Config.  
Enter the printer's IP address from a computer that is connected to the same network as the printer.  
You can check the IP address of the printer from the following menu.  
**Settings > General Settings > Network Settings > Network Status > Wired LAN/Wi-Fi Status**
2. Enter the administrator password to log in as an administrator.
3. Select in the following order.  
**Device Management** tab > **Contacts Manager**
4. Select **View Options**.
5. Select **Search Options**.
6. Click **OK**.
7. Follow the on-screen instructions.

## Configuring Periodic Cleaning

You can make settings to perform periodic cleaning of the print head.

1. Enter the printer's IP address into a browser to access Web Config.  
Enter the printer's IP address from a computer that is connected to the same network as the printer.  
You can check the IP address of the printer from the following menu.  
**Settings > General Settings > Network Settings > Network Status > Wired LAN/Wi-Fi Status**
2. Enter the administrator password to log in as an administrator.
3. Select in the following order.  
**Device Management** tab > **Periodic Cleaning**
4. Select an option from the list.
5. When selecting **Schedule**, specify the time to perform cleaning from the list.
6. Click **OK**.

### Related Information

- ➔ [“Default Value of the Administrator Password” on page 19](#)
- ➔ [“Periodic Cleaning:” on page 386](#)

## Controlling the Power Supply to the Printer Using Web Config

You can turn off or restart the printer from a computer using Web Config even when the computer is located remotely away from the printer.

1. Enter the printer's IP address into a browser to access Web Config.  
Enter the printer's IP address from a computer that is connected to the same network as the printer.  
You can check the IP address of the printer from the following menu.  
**Settings > General Settings > Network Settings > Network Status > Wired LAN/Wi-Fi Status**
2. Enter the administrator password to log in as an administrator.
3. Select in the following order.  
**Device Management** tab > **Power**
4. Select **Power Off** or **Reboot**
5. Click **Execute**.

### Related Information

- ➔ [“Default Value of the Administrator Password” on page 19](#)

## Restore Default Settings

You can select the network settings or other settings stored in the printer and restore these settings to their defaults.

1. Enter the printer's IP address into a browser to access Web Config.  
Enter the printer's IP address from a computer that is connected to the same network as the printer.  
You can check the IP address of the printer from the following menu.  
**Settings > General Settings > Network Settings > Network Status > Wired LAN/Wi-Fi Status**
2. Enter the administrator password to log in as an administrator.
3. Select in the following order.  
**Device Management** tab > **Restore Default Settings**
4. Select an option from the list.
5. Click **Execute**.  
Follow the on-screen instructions.

## Related Information

➔ [“Default Value of the Administrator Password” on page 19](#)

---

# Product Security Settings

## Restricting Available Features

You can register user accounts on the printer, link them with functions, and control functions that users can use.

When enabling access control, the user can use functions such as copy, fax, etc. by entering the password on the printer's control panel and logging in to the printer.

The unavailable functions will be grayed out and cannot be selected.

From the computer, when you register the authentication information to the printer driver or scanner driver, you will be able to print or scan. For details of the driver settings, see the driver's help or manual.

## Creating the User Account

Create the user account for access control.

1. Enter the printer's IP address into a browser to access Web Config.

Enter the printer's IP address from a computer that is connected to the same network as the printer.

You can check the IP address of the printer from the following menu.

**Settings > General Settings > Network Settings > Network Status > Wired LAN/Wi-Fi Status**

2. Enter the administrator password to log in as an administrator.

3. Select in the following order.

**Product Security** tab > **Access Control Settings** > **User Settings**

4. Click **Add** for the number you want to register.

 **Important:**

*When using the printer with the authentication system of Epson or other companies, register the user name of the restriction setting in number 2 to number 10.*

*Application software such as the authentication system uses number one, so that the user name is not displayed on the printer's control panel.*

5. Set each item.

- User Name :

Enter the name displayed on the user name list between 1 and 14 characters long using alphanumeric characters.

- Password :

Enter a password between 0 and 20 characters long in ASCII (0x20-0x7E). When initializing the password, leave it blank.

- Select the check box to enable or disable each function.

Select the function that you permit to use.

6. Click **Apply**.

Return to the user setting list after a specific length of time.

Check that the user name you registered on **User Name** is displayed and changed **Add** to **Edit**.

### **Related Information**

- ➔ [“Default Value of the Administrator Password” on page 19](#)

### ***Editing the User Account***

Edit the account registered to access control.

1. Enter the printer's IP address into a browser to access Web Config.  
Enter the printer's IP address from a computer that is connected to the same network as the printer.  
You can check the IP address of the printer from the following menu.  
**Settings > General Settings > Network Settings > Network Status > Wired LAN/Wi-Fi Status**
2. Enter the administrator password to log in as an administrator.
3. Select in the following order.  
**Product Security** tab > **Access Control Settings** > **User Settings**
4. Click **Edit** for the number you want to edit.
5. Change each item.
6. Click **Apply**.  
Return to the user setting list after a specific length of time.

### **Related Information**

- ➔ [“Default Value of the Administrator Password” on page 19](#)

### ***Deleting the User Account***

Delete the account registered to access control.

1. Enter the printer's IP address into a browser to access Web Config.  
Enter the printer's IP address from a computer that is connected to the same network as the printer.  
You can check the IP address of the printer from the following menu.  
**Settings > General Settings > Network Settings > Network Status > Wired LAN/Wi-Fi Status**
2. Enter the administrator password to log in as an administrator.

3. Select in the following order.  
**Product Security** tab > **Access Control Settings** > **User Settings**
4. Click **Edit** for the number you want to delete.
5. Click **Delete**.



**Important:**

*When clicking **Delete**, the user account will be deleted without a confirmation message. Take care when deleting the account.*

Return to the user setting list after a specific length of time.

### Related Information

- ➔ [“Default Value of the Administrator Password” on page 19](#)

## Enabling Access Control

When enabling access control, only the registered user will be able to use the printer.

**Note:**

*When Access Control Settings is enabled, you need to notify the user of their account information.*

1. Enter the printer's IP address into a browser to access Web Config.  
Enter the printer's IP address from a computer that is connected to the same network as the printer.  
You can check the IP address of the printer from the following menu.  
**Settings > General Settings > Network Settings > Network Status > Wired LAN/Wi-Fi Status**
2. Enter the administrator password to log in as an administrator.
3. Select in the following order.  
**Product Security** tab > **Access Control Settings** > **Basic**
4. Select **Enables Access Control**.  
If you enable Access Control and want to print or scan from smart devices that do not have authentication information, select **Allow printing and scanning without authentication information from a computer**.
5. Click **OK**.  
The completion message is displayed after a certain period of time.  
Confirm that the icons such as copy and scan are grayed out on the printer's control panel.

### Related Information

- ➔ [“Default Value of the Administrator Password” on page 19](#)
- ➔ [“Using a Printer with the Access Control Feature Enabled” on page 283](#)

## Restricting USB Connections and Use of External Memory

You can disable the interface that is used to connect the device to the printer. Make the restriction settings to restrict printing and scanning other than via network.

**Note:**

You can also make the restriction settings on the printer's control panel.

*Memory Device* : **Settings > General Settings > Printer Settings > Memory Device Interface > Memory Device**

*PC Connection via USB* : **Settings > General Settings > Printer Settings > PC Connection via USB**

1. Enter the printer's IP address into a browser to access Web Config.

Enter the printer's IP address from a computer that is connected to the same network as the printer.

You can check the IP address of the printer from the following menu.

**Settings > General Settings > Network Settings > Network Status > Wired LAN/Wi-Fi Status**

2. Enter the administrator password to log in as an administrator.

3. Select in the following order.

**Product Security** tab > **External Interface**

4. Select **Disable** on the functions you want to set.

Select **Enable** when you want to cancel controlling.

Memory Device

Prohibit saving the data to external memory via USB port for external device connection.

PC connection via USB

You can restrict the usage of the USB connection from the computer. If you want to restrict it, select **Disable**.

5. Click **OK**.

6. Check that the disabled port cannot be used.

Memory Device

Confirm that there is no response when connecting a storage device such as USB memory to the external interface USB port.

PC connection via USB

If the driver was installed on the computer

Connect the printer to the computer using a USB cable, and then confirm that the printer does not print and scan.

If the driver was not installed on the computer

Windows:

Open the device manager and keep it, connect the printer to the computer using a USB cable, and then confirm that the device manager's display contents stays unchanged.

Mac OS:

Connect the printer to the computer using a USB cable, and then confirm that the printer is not listed if you want to add the printer from **Printers & Scanners**.



### Related Information

➔ [“Default Value of the Administrator Password” on page 19](#)

## Encrypting the Password

Password encryption allows you to encrypt confidential information (all passwords, certificate private keys) stored in the printer.

1. Enter the printer's IP address into a browser to access Web Config.  
Enter the printer's IP address from a computer that is connected to the same network as the printer.  
You can check the IP address of the printer from the following menu.  
**Settings > General Settings > Network Settings > Network Status > Wired LAN/Wi-Fi Status**

2. Enter the administrator password to log in as an administrator.

3. Select in the following order.

**Product Security tab > Password Encryption**

**Note:**

*You can also set up from the printer's control panel.*

**Settings > General Settings > System Administration > Security Settings > Password Encryption**

4. Select **ON** to enable encryption.

5. Click **OK**.

### Related Information

➔ [“Default Value of the Administrator Password” on page 19](#)

## Using the Audit Log Feature

You can enable the Audit Log feature or export log data.

Checking the audit logs periodically can help to identify improper usage early on and trace possible security issues.

1. Enter the printer's IP address into a browser to access Web Config.  
Enter the printer's IP address from a computer that is connected to the same network as the printer.  
You can check the IP address of the printer from the following menu.  
**Settings > General Settings > Network Settings > Network Status > Wired LAN/Wi-Fi Status**

2. Enter the administrator password to log in as an administrator.

3. Select in the following order.

**Product Security tab > Audit Log**

4. Change the settings as necessary.

**Audit log setting**

Select **ON**, and then click **OK** to enable this feature.

**Note:**

*You can also set up from the printer's control panel.*

**Settings > General Settings > System Administration > Security Settings > Audit Log**

**Exports the audit logs to the CSV file.**

Click **Export** to export the log as a CSV file.

**Deletes all audit logs.**

Click **Delete** to delete all log data.

### Related Information

➔ [“Default Value of the Administrator Password” on page 19](#)

## Restricting File Operations from PDL

This feature protects files from unauthorized PDL operations.

1. Enter the printer's IP address into a browser to access Web Config.

Enter the printer's IP address from a computer that is connected to the same network as the printer.

You can check the IP address of the printer from the following menu.

**Settings > General Settings > Network Settings > Network Status > Wired LAN/Wi-Fi Status**

2. Enter the administrator password to log in as an administrator.

3. Select in the following order.

**Product Security tab > File Operations from PDL**

4. Sets whether or not allow **File Operations from PDL**.

5. Click **OK**.

### Related Information

➔ [“Default Value of the Administrator Password” on page 19](#)

## Changing the Administrator Password Using Web Config

You can set the administrator password using Web Config.

Changing the password prevents unauthorized reading or modification of the information stored on the device, such as ID, password, network settings, contacts, etc. It also reduces a wide range of security risks, such as information leaks in network environments and security policies.

1. Enter the printer's IP address into a browser to access Web Config.

Enter the printer's IP address from a computer that is connected to the same network as the printer.

You can check the IP address of the printer from the following menu.

**Settings > General Settings > Network Settings > Network Status > Wired LAN/Wi-Fi Status**

2. Enter the administrator password to log in as an administrator.
3. Select in the following order.  
**Product Security** tab > **Change Administrator Password**
4. Enter the current password in **Current password**.
5. Enter the new password in **New Password** and in **Confirm New Password**. Enter the user name, if necessary.
6. Click **OK**.

**Note:**

To restore the administrator password to the initial password, click **Restore Default Settings** on the **Change Administrator Password** screen.

**Related Information**

➔ [“Default Value of the Administrator Password” on page 19](#)

## Enabling Program Verification on Start Up

If you enable the Program Verification feature, the printer performs verification at start up to check if unauthorized third parties have tampered with the program. If any issues are detected, the printer does not start.

1. Enter the printer's IP address into a browser to access Web Config.  
Enter the printer's IP address from a computer that is connected to the same network as the printer.  
You can check the IP address of the printer from the following menu.  
**Settings > General Settings > Network Settings > Network Status > Wired LAN/Wi-Fi Status**

2. Enter the administrator password to log in as an administrator.
3. Select in the following order.

**Product Security** tab > **Program Verification on Start Up**

**Note:**

You can also set up from the printer's control panel.

**Settings > General Settings > System Administration > Security Settings > Program Verification on Start Up**

4. Select **ON** to enable **Program Verification on Start Up**.
5. Click **OK**.

**Related Information**

➔ [“Default Value of the Administrator Password” on page 19](#)

## Configuring Domain Restrictions

By applying restriction rules to domain names, you can reduce the risk of information leaks due to accidental transmissions.

1. Enter the printer's IP address into a browser to access Web Config.  
Enter the printer's IP address from a computer that is connected to the same network as the printer.  
You can check the IP address of the printer from the following menu.  
**Settings > General Settings > Network Settings > Network Status > Wired LAN/Wi-Fi Status**
2. Enter the administrator password to log in as an administrator.
3. Select in the following order.  
**Product Security tab > Domain Restrictions**
4. Change the settings as necessary.
  - Restriction Rule**  
Select how to restrict email transmissions.
  - Domain Name**  
Add or delete the domain name to be restricted.
5. Click OK.

### Related Information

➔ [“Default Value of the Administrator Password” on page 19](#)

---

## Network Security Settings

### Controlling Using Protocols

You can print using a variety of pathways and protocols.

If you are using a multi-function printer, you can use network scanning and PC-FAX from an unspecified number of network computers.

You can lower unintended security risks by restricting printing from specific pathways or by controlling the available functions.

Follow the steps below to configure the protocol settings.

1. Enter the printer's IP address into a browser to access Web Config.  
Enter the printer's IP address from a computer that is connected to the same network as the printer.  
You can check the IP address of the printer from the following menu.  
**Settings > General Settings > Network Settings > Network Status > Wired LAN/Wi-Fi Status**
2. Enter the administrator password to log in as an administrator.

3. Select in the following order.

**Network Security** tab > **Protocol**

4. Configure each item.

5. Click **Next**.

6. Click **OK**.

The settings are applied to the printer.

**Related Information**

- ➔ [“Default Value of the Administrator Password” on page 19](#)
- ➔ [“Protocols you can Enable or Disable” on page 441](#)
- ➔ [“Protocol Setting Items” on page 442](#)

**Protocols you can Enable or Disable**

Protocol	Description
Bonjour Settings	You can specify whether to use Bonjour. Bonjour is used to search for devices, print, and so on.
iBeacon Settings	You can enable or disable the iBeacon transmission function. When enabled, you can search for the printer from iBeacon-enabled devices.
SLP Settings	You can enable or disable the SLP function. SLP is used for push scanning and network searching in EpsonNet Config.
WSD Settings	You can enable or disable the WSD function. When this is enabled, you can add WSD devices, and print from the WSD port.
LLTD Settings	You can enable or disable the LLTD function. When this is enabled, it is displayed on the Windows network map.
LLMNR Settings	You can enable or disable the LLMNR function. When this is enabled, you can use name resolution without NetBIOS even if you cannot use DNS.
LPR Settings	You can specify whether or not to allow LPR printing. When this is enabled, you can print from the LPR port.
RAW(Port9100) Settings	You can specify whether or not to allow printing from the RAW port (Port 9100). When this is enabled, you can print from the RAW port (Port 9100).
RAW(Custom Port) Settings	You can specify whether or not to allow printing from the RAW port (custom port). When this is enabled, you can print from the RAW port (custom port).
IPP Settings	You can enable or disable the IPP function. When enabled, you will be able to print over the Internet. It is also displayed when searching for devices on the network.
FTP Settings	You can specify whether or not to allow FTP printing. When this is enabled, you can print over an FTP server.
SNMPv1/v2c Settings	You can specify whether or not to enable SNMPv1/v2c. This is used to set up devices, monitoring, and so on.

Protocol	Description
SNMPv3 Settings	You can specify whether or not to enable SNMPv3. This is used to set up encrypted devices, monitoring, etc.

### Related Information

- ➔ [“Controlling Using Protocols” on page 440](#)
- ➔ [“Protocol Setting Items” on page 442](#)

## Protocol Setting Items

### Bonjour Settings

Items	Setting value and Description
Use Bonjour	Select this to search for or use devices through Bonjour.
Bonjour Name	Displays the Bonjour name.
Bonjour Service Name	Displays the Bonjour service name.
Location	Displays the Bonjour location name.
Top Priority Protocol	Select the top priority protocol for Bonjour print.
Wide-Area Bonjour	Set whether to use Wide-Area Bonjour.

### iBeacon Settings

Items	Setting value and Description
Enable iBeacon Transmission	Select this to enable the iBeacon transmission function.

### SLP Settings

Items	Setting value and Description
Enable SLP	Select this to enable the SLP function. This is used such as network searching in EpsonNet Config.

### WSD Settings

Items	Setting value and Description
Enable WSD	Select this to enable adding devices using WSD, and print from the WSD port. If you do not want this product to search for devices, disable this item and disable the <b>Enable IPP</b> item.
Printing Timeout (sec)	Enter the communication timeout value for WSD printing between 3 to 3,600 seconds.
Scanning Timeout (sec)	Enter the communication timeout value for WSD scanning between 3 to 3,600 seconds.

Items	Setting value and Description
Device Name	Displays the WSD device name.
Location	Displays the WSD location name.

#### LLTD Settings

Items	Setting value and Description
Enable LLTD	Select this to enable LLTD. The printer is displayed in the Windows network map.
Device Name	Displays the LLTD device name.

#### LLMNR Settings

Items	Setting value and Description
Enable LLMNR	Select this to enable LLMNR. You can use name resolution without NetBIOS even if you cannot use DNS.

#### LPR Settings

Items	Setting value and Description
Allow LPR Port Printing	Select to allow printing from the LPR port.
Printing Timeout (sec)	Enter the timeout value for LPR printing between 0 to 3,600 seconds. If you do not want to timeout, enter 0.

#### RAW(Port9100) Settings

Items	Setting value and Description
Allow RAW(Port9100) Printing	Select to allow printing from the RAW port (Port 9100).
Printing Timeout (sec)	Enter the timeout value for RAW (Port 9100) printing between 0 to 3,600 seconds. If you do not want to timeout, enter 0.

#### RAW(Custom Port) Settings

Items	Setting value and Description
Allow RAW(Custom Port) Printing	Select to allow printing from the RAW port (custom port).
Port Number	Enter the port number for RAW printing between 1024 and 65535 (except for 9100, 1865, 2968).
Printing Timeout (sec)	Enter the timeout value for RAW (custom port) printing between 0 to 3,600 seconds. If you do not want to timeout, enter 0.

#### IPP Settings

Items	Setting value and Description
Enable IPP	Select to enable IPP communication. When enabled, you will be able to print over the Internet. It is also displayed when searching for devices on the network. Only printers that support IPP are displayed.
Allow Non-secure Communication	Select <b>Allowed</b> to allow the printer to communicate without any security measures (IPP).
Communication Timeout (sec)	Enter the timeout value for IPP printing between 0 to 3,600 seconds.
Require PIN Code when using IPP printing	Select whether or not to require a PIN code when using IPP printing. If you select <b>Yes</b> , IPP print jobs without PIN codes are not saved in the printer.
URL(Network)	Displays IPP URLs (http and https) when the printer is connected to the network. The URL is a combined value of the printer's IP address, Port number, and IPP printer name.
URL(Wi-Fi Direct)	Displays IPP URLs (http and https) when the printer is connected by Wi-Fi Direct. The URL is a combined value of the printer's IP address, Port number, and IPP printer name.
Printer Name	Displays the IPP printer name.
Location	Displays the IPP location.

#### FTP Settings

Items	Setting value and Description
Enable FTP Server	Select to enable FTP printing. Only printers that support FTP printing are displayed.
Communication Timeout (sec)	Enter the timeout value for FTP communication between 0 to 3,600 seconds. If you do not want to timeout, enter 0.

#### SNMPv1/v2c Settings

Items	Setting value and Description
Enable SNMPv1	SNMPv1 is enabled when the box is checked.
Enable SNMPv2c	SNMPv2c is enabled when the box is checked.
Access Authority	Set the access authority when SNMPv1 or SNMPv2c is enabled. Select <b>Read Only</b> or <b>Read/Write</b> .
Community Name (Read Only)	Enter 0 to 32 ASCII (0x20 to 0x7E) characters.
Community Name (Read/Write)	Enter 0 to 32 ASCII (0x20 to 0x7E) characters.
Allow access from Epson tools	Set whether or not to allow information to be written by Epson tools such as Epson Device Admin.

#### SNMPv3 Settings



Items		Setting value and Description
Enable SNMPv3		SNMPv3 is enabled when the box is checked.
User Name		Enter between 1 and 32 characters using 1 byte characters.
Authentication Settings		
	Algorithm	Select an algorithm for an authentication for SNMPv3.
	Password	Enter the password for an authentication for SNMPv3. Enter between 8 and 32 characters in ASCII (0x20-0x7E). If you do not specify this, leave it blank.
	Confirm Password	Enter the password you configured for confirmation.
Encryption Settings		
	Algorithm	Select an algorithm for an encryption for SNMPv3.
	Password	Enter the password for an encryption for SNMPv3. Enter between 8 and 32 characters in ASCII (0x20-0x7E). If you do not specify this, leave it blank.
	Confirm Password	Enter the password you configured for confirmation.
Context Name		Enter within 32 characters or less in Unicode (UTF-8). If you do not specify this, leave it blank. The number of characters that can be entered varies depending on the language.

### Related Information

- ➔ [“Controlling Using Protocols” on page 440](#)
- ➔ [“Protocols you can Enable or Disable” on page 441](#)

## Using a Digital Certificate

### About Digital Certification

#### CA-signed Certificate

This is a certificate signed by the CA (Certificate Authority.) You can obtain it to apply to the Certificate Authority. This certificate certifies the existence of the printer is and used for SSL/TLS communication so that you can ensure the safety of data communication.

When it is used for SSL/TLS communication, it is used as a server certificate.

When it is set to IPsec/IP Filtering or IEEE802.1x communication, it is used as a client certificate.

#### ❑ CA Certificate

This is a certificate that is in chain of the CA-signed Certificate, also called the intermediate CA certificate. It is used by the web browser to validate the path of the printer's certificate when accessing the server of the other party or Web Config.

For the CA Certificate, set when to validate the path of server certificate accessing from the printer. For the printer, set to certify the path of the CA-signed Certificate for SSL/TLS connection.

You can obtain the CA certificate of the printer from the Certification Authority where the CA certificate is issued.

Also, you can obtain the CA certificate used to validate the server of the other party from the Certification Authority that issued the CA-signed Certificate of the other server.

#### ❑ Self-signed Certificate

This is a certificate that the printer signs and issues itself. It is also called the root certificate. Because the issuer certifies itself, it is not reliable and cannot prevent impersonation.

Use it when making the security setting and performing simple SSL/TLS communication without the CA-signed Certificate.

If you use this certificate for an SSL/TLS communication, a security alert may be displayed on a web browser because the certificate is not registered on a web browser. You can use the Self-signed Certificate only for an SSL/TLS communication.

### Related Information

- ➔ [“Updating a Self-signed Certificate” on page 450](#)
- ➔ [“Configuring a CA Certificate” on page 451](#)

## Configuring a CA-signed Certificate

### Obtaining a CA-signed Certificate

To obtain a CA-signed certificate, create a CSR (Certificate Signing Request) and apply it to certificate authority. You can create a CSR using Web Config and a computer.

Follow the steps to create a CSR and obtain a CA-signed certificate using Web Config. When creating a CSR using Web Config, a certificate is the PEM/DER format.

1. Enter the printer's IP address into a browser to access Web Config.  
Enter the printer's IP address from a computer that is connected to the same network as the printer.  
You can check the IP address of the printer from the following menu.  
**Settings > General Settings > Network Settings > Network Status > Wired LAN/Wi-Fi Status**
2. Enter the administrator password to log in as an administrator.
3. Select in the following order.  
**Network Security** tab. > **SSL/TLS > Certificate** or **IPsec/IP Filtering > Client Certificate** or **IEEE802.1X > Client Certificate**  
Whatever you choose, you can obtain the same certificate and use it in common.
4. Click **Generate** of CSR.  
A CSR creating page is opened.

- Enter a value for each item.

**Note:**

Available key length and abbreviations vary by a certificate authority. Create a request according to rules of each certificate authority.

- Click **OK**.

A completion message is displayed.

- Select the **Network Security** tab. Next, select **SSL/TLS > Certificate**, or **IPsec/IP Filtering > Client Certificate** or **IEEE802.1X > Client Certificate**.

- Click one of the download buttons of **CSR** according to a specified format by each certificate authority to download a CSR to a computer.



**Important:**

Do not generate a CSR again. If you do so, you may not be able to import an issued CA-signed Certificate.

- Send the CSR to a certificate authority and obtain a CA-signed Certificate.

Follow the rules of each certificate authority on sending method and form.

- Save the issued CA-signed Certificate to a computer connected to the printer.

Obtaining a CA-signed Certificate is complete when you save a certificate to a destination.

**Related Information**

➔ [“Default Value of the Administrator Password” on page 19](#)

**CSR Setting Items**

Items	Settings and Explanation
Key Length	Select a key length for a CSR.
Common Name	<p>You can enter between 1 and 128 characters. If this is an IP address, it should be a static IP address. You can enter 1 to 5 IPv4 addresses, IPv6 addresses, host names, FQDNs by separating them with commas.</p> <p>The first element is stored to the common name, and other elements are stored to the alias field of the certificate subject.</p> <p>Example:                      Printer's IP address : 192.0.2.123, Printer name : EPSONA1B2C3                      Common Name : EPSONA1B2C3,EPSONA1B2C3.local,192.0.2.123</p>
Organization/ Organizational Unit/ Locality/ State/Province	You can enter between 0 and 64 characters in ASCII (0x20-0x7E). You can divide distinguished names with commas.
Country	Enter a country code in two-digit number specified by ISO-3166.
Sender's Email Address	You can enter the sender's email address for the mail server setting. Enter the same email address as the <b>Sender's Email Address</b> for the <b>Network</b> tab > <b>Email Server</b> > <b>Basic</b> .

## Related Information

➔ [“Obtaining a CA-signed Certificate” on page 446](#)

## Importing a CA-signed Certificate

Import the obtained CA-signed Certificate to the printer.



### Important:

- Make sure that the printer's date and time is set correctly. Certificate may be invalid.
- If you obtain a certificate using a CSR created from Web Config, you can import a certificate one time.

1. Enter the printer's IP address into a browser to access Web Config.  
Enter the printer's IP address from a computer that is connected to the same network as the printer.  
You can check the IP address of the printer from the following menu.  
**Settings > General Settings > Network Settings > Network Status > Wired LAN/Wi-Fi Status**
2. Enter the administrator password to log in as an administrator.
3. Select in the following order.  
**Network Security tab. > SSL/TLS > Certificate, or IPsec/IP Filtering > Client Certificate or IEEE802.1X**
4. Click **Import**  
A certificate importing page is opened.
5. Enter a value for each item. Set **CA Certificate 1** and **CA Certificate 2** when verifying the path of the certificate on the web browser that accesses the printer.  
Depending on where you create a CSR and the file format of the certificate, required settings may vary. Enter values to required items according to the following.
  - A certificate of the PEM/DER format obtained from Web Config
    - Private Key:** Do not configure because the printer contains a private key.
    - Password:** Do not configure.
    - CA Certificate 1/CA Certificate 2:** Optional
  - A certificate of the PEM/DER format obtained from a computer
    - Private Key:** You need to set.
    - Password:** Do not configure.
    - CA Certificate 1/CA Certificate 2:** Optional
  - A certificate of the PKCS#12 format obtained from a computer
    - Private Key:** Do not configure.
    - Password:** Optional
    - CA Certificate 1/CA Certificate 2:** Do not configure.
6. Click **OK**.  
A completion message is displayed.

**Note:**

Click **Confirm** to verify the certificate information.

**Related Information**

- ➔ [“Default Value of the Administrator Password” on page 19](#)
- ➔ [“Deleting a CA-signed Certificate” on page 449](#)

**CA-signed Certificate Importing Setting Items**

Items	Settings and Explanation
Server Certificate or Client Certificate	Select a certificate’s format. For SSL/TLS connection, the Server Certificate is displayed. For IPsec/IP Filtering or IEEE802.1x, the Client Certificate is displayed.
Private Key	If you obtain a certificate of the PEM/DER format by using a CSR created from a computer, specify a private key file that is match a certificate.
Password	If the file format is <b>Certificate with Private Key (PKCS#12)</b> , enter the password for encrypting the private key that is set when you obtain the certificate.
CA Certificate 1	If your certificate’s format is <b>Certificate (PEM/DER)</b> , import a certificate of a certificate authority that issues a CA-signed Certificate used as server certificate. Specify a file if you need.
CA Certificate 2	If your certificate’s format is <b>Certificate (PEM/DER)</b> , import a certificate of a certificate authority that issues CA Certificate 1. Specify a file if you need.

**Related Information**

- ➔ [“Importing a CA-signed Certificate” on page 448](#)

**Deleting a CA-signed Certificate**

You can delete an imported certificate when the certificate has expired or when an encrypted connection is no longer necessary.



**Important:**

*If you obtain a certificate using a CSR created from Web Config, you cannot import a deleted certificate again. In this case, create a CSR and obtain a certificate again.*

1. Enter the printer's IP address into a browser to access Web Config.  
Enter the printer's IP address from a computer that is connected to the same network as the printer.  
You can check the IP address of the printer from the following menu.  
**Settings > General Settings > Network Settings > Network Status > Wired LAN/Wi-Fi Status**
2. Enter the administrator password to log in as an administrator.
3. Select in the following order.  
**Network Security** tab.

4. Select one of the following.
  - SSL/TLS > Certificate**
  - IPsec/IP Filtering > Client Certificate**
  - IEEE802.1X > Client Certificate**
5. Click **Delete**.
6. Confirm that you want to delete the certificate in the message displayed.

#### Related Information

➔ [“Default Value of the Administrator Password” on page 19](#)

## Updating a Self-signed Certificate

Because the Self-signed Certificate is issued by the printer, you can update it when it has expired or when the content described changes.

1. Enter the printer's IP address into a browser to access Web Config.  
Enter the printer's IP address from a computer that is connected to the same network as the printer.  
You can check the IP address of the printer from the following menu.  
**Settings > General Settings > Network Settings > Network Status > Wired LAN/Wi-Fi Status**
2. Enter the administrator password to log in as an administrator.
3. Select in the following order.  
**Network Security tab > SSL/TLS > Certificate**
4. Click **Update**.
5. Enter **Common Name**.  
You can enter up to 5 IPv4 addresses, IPv6 addresses, host names, FQDNs between 1 to 128 characters and separating them with commas. The first parameter is stored to the common name, and the others are stored to the alias field for the subject of the certificate.  
Example:  
Printer's IP address : 192.0.2.123, Printer name : EPSONA1B2C3  
Common name : EPSONA1B2C3,EPSONA1B2C3.local,192.0.2.123
6. Specify a validity period for the certificate.
7. Click **Next**.  
A confirmation message is displayed.
8. Click **OK**.  
The printer is updated.

#### Note:

You can check the certificate information from **Network Security tab > SSL/TLS > Certificate > Self-signed Certificate** and click **Confirm**.

### **Related Information**

➔ [“Default Value of the Administrator Password” on page 19](#)

## **Configuring a CA Certificate**

When you set the CA Certificate, you can validate the path to the CA certificate of the server that the printer accesses. This can prevent impersonation.

You can obtain the CA Certificate from the Certification Authority where the CA-signed Certificate is issued.

### **Importing a CA Certificate**

Import the CA Certificate to the printer.

1. Enter the printer's IP address into a browser to access Web Config.  
Enter the printer's IP address from a computer that is connected to the same network as the printer.  
You can check the IP address of the printer from the following menu.  
**Settings > General Settings > Network Settings > Network Status > Wired LAN/Wi-Fi Status**
2. Enter the administrator password to log in as an administrator.
3. Select in the following order.  
**Network Security tab > CA Certificate**
4. Click **Import**.
5. Specify the CA Certificate you want to import.
6. Click **OK**.

When importing is complete, you are returned to the **CA Certificate** screen, and the imported CA Certificate is displayed.

### **Related Information**

➔ [“Default Value of the Administrator Password” on page 19](#)

### **Deleting a CA Certificate**

You can delete the imported CA Certificate.

1. Enter the printer's IP address into a browser to access Web Config.  
Enter the printer's IP address from a computer that is connected to the same network as the printer.  
You can check the IP address of the printer from the following menu.  
**Settings > General Settings > Network Settings > Network Status > Wired LAN/Wi-Fi Status**
2. Enter the administrator password to log in as an administrator.

3. Select in the following order.  
**Network Security** tab > **CA Certificate**
4. Click **Delete** next to the CA Certificate that you want to delete.
5. Confirm that you want to delete the certificate in the message displayed.
6. Click **Reboot Network**, and then check that the deleted CA Certificate is not listed on the updated screen.

### Related Information

➔ [“Default Value of the Administrator Password” on page 19](#)

## SSL/TLS Communication with the Printer

When the server certificate is set using SSL/TLS (Secure Sockets Layer/Transport Layer Security) communication to the printer, you can encrypt the communication path between computers. Do this if you want to prevent remote and unauthorized access.

### Configuring Basic SSL/TLS Settings

If the printer supports the HTTPS server feature, you can use an SSL/TLS communication to encrypt communications. You can configure and manage the printer using Web Config while ensuring security.

Configure encryption strength and redirect feature.

1. Enter the printer's IP address into a browser to access Web Config.  
Enter the printer's IP address from a computer that is connected to the same network as the printer.  
You can check the IP address of the printer from the following menu.  
**Settings > General Settings > Network Settings > Network Status > Wired LAN/Wi-Fi Status**
2. Enter the administrator password to log in as an administrator.
3. Select in the following order.  
**Network Security** tab > **SSL/TLS** > **Basic**
4. Select a value for each item.
  - Encryption Strength  
Select the level of encryption strength.
  - Redirect HTTP to HTTPS  
Select enable or disable. The default value is "Enable".
  - TLS 1.0  
Select enable or disable. The default value is "Disable".
  - TLS.1.1  
Select enable or disable. The default value is "Disable".
  - TLS.1.2  
Select enable or disable. The default value is "Enable".



5. Click **Next**.  
A confirmation message is displayed.
6. Click **OK**.  
The printer is updated.

#### **Related Information**

➔ [“Default Value of the Administrator Password” on page 19](#)

## **Configuring a Server Certificate for the Printer**

1. Enter the printer's IP address into a browser to access Web Config.  
Enter the printer's IP address from a computer that is connected to the same network as the printer.  
You can check the IP address of the printer from the following menu.  
**Settings > General Settings > Network Settings > Network Status > Wired LAN/Wi-Fi Status**
2. Enter the administrator password to log in as an administrator.
3. Select in the following order.  
**Network Security** tab > **SSL/TLS** > **Certificate**
4. Specify a certificate to use on **Server Certificate**.
  - Self-signed Certificate  
A self-signed certificate has been generated by the printer. If you do not obtain a CA-signed certificate, select this.
  - CA-signed Certificate  
If you obtain and import a CA-signed certificate in advance, you can specify this.
5. Click **Next**.  
A confirmation message is displayed.
6. Click **OK**.  
The printer is updated.

#### **Related Information**

- ➔ [“Default Value of the Administrator Password” on page 19](#)
- ➔ [“Configuring a CA-signed Certificate” on page 446](#)
- ➔ [“Updating a Self-signed Certificate” on page 450](#)

## Encrypted Communication Using IPsec/IP Filtering

### About IPsec/IP Filtering

You can filter traffic based on IP addresses, services, and port by using IPsec/IP Filtering function. By combining of the filtering, you can configure the printer to accept or block specified clients and specified data. Additionally, you can improve security level by using an IPsec.

**Note:**

*Computers that run Windows Vista or later or Windows Server 2008 or later support IPsec.*

### Configuring Default Policy

To filter traffic, configure the default policy. The default policy applies to every user or group connecting to the printer. For more fine-grained control over users and groups of users, configure group policies.

1. Enter the printer's IP address into a browser to access Web Config.  
 Enter the printer's IP address from a computer that is connected to the same network as the printer.  
 You can check the IP address of the printer from the following menu.  
**Settings > General Settings > Network Settings > Network Status > Wired LAN/Wi-Fi Status**
2. Enter the administrator password to log in as an administrator.
3. Select in the following order.  
**Network Security tab > IPsec/IP Filtering > Basic**
4. Enter a value for each item.
5. Click **Next**.  
 A confirmation message is displayed.
6. Click **OK**.  
 The printer is updated.

### Default Policy Setting Items

#### Default Policy

Items	Settings and Explanation
IPsec/IP Filtering	You can enable or disable an IPsec/IP Filtering feature.

**Access Control**

Configure a control method for traffic of IP packets.

Items	Settings and Explanation
Permit Access	Select this to permit configured IP packets to pass through.
Refuse Access	Select this to refuse configured IP packets to pass through.
IPsec	Select this to permit configured IPsec packets to pass through.

**IKE Version**

Select **IKEv1** or **IKEv2** for **IKE Version**. Select one of them according to the device that the printer is connected to.

**IKEv1**

The following items are displayed when you select **IKEv1** for **IKE Version**.

Items	Settings and Explanation
Authentication Method	To select <b>Certificate</b> , you need to obtain and import a CA-signed certificate in advance.
Pre-Shared Key	If you select <b>Pre-Shared Key</b> for <b>Authentication Method</b> , enter a pre-shared key between 1 and 127 characters.
Confirm Pre-Shared Key	Enter the key you configured for confirmation.

**IKEv2**

The following items are displayed when you select **IKEv2** for **IKE Version**.

Items	Settings and Explanation	
Local	Authentication Method	To select <b>Certificate</b> , you need to obtain and import a CA-signed certificate in advance.
	ID Type	If you select <b>Pre-Shared Key</b> for <b>Authentication Method</b> , select the type of ID for the printer.
	ID	Enter the printer's ID that matches the type of ID. You cannot use "@", "#", and "=" for the first character. <b>Distinguished Name</b> : Enter 1 to 255 1-byte ASCII (0x20 to 0x7E) characters. You need to include "=". <b>IP Address</b> : Enter IPv4 or IPv6 format. <b>FQDN</b> : Enter a combination of between 1 and 255 characters using A-Z, a-z, 0-9, "-", and period (.). <b>Email Address</b> : Enter 1 to 255 1-byte ASCII (0x20 to 0x7E) characters. You need to include "@". <b>Key ID</b> : Enter 1 to 255 1-byte ASCII (0x20 to 0x7E) characters.
	Pre-Shared Key	If you select <b>Pre-Shared Key</b> for <b>Authentication Method</b> , enter a pre-shared key between 1 and 127 characters.
	Confirm Pre-Shared Key	Enter the key you configured for confirmation.

Items		Settings and Explanation
Remote	Authentication Method	To select <b>Certificate</b> , you need to obtain and import a CA-signed certificate in advance.
	ID Type	If you select <b>Pre-Shared Key</b> for <b>Authentication Method</b> , select the type of ID for the device that you want to authenticate.
	ID	Enter the printer's ID that matches to the type of ID. You cannot use "@", "#", and "=" for the first character. <b>Distinguished Name</b> : Enter 1 to 255 1-byte ASCII (0x20 to 0x7E) characters. You need to include "=". <b>IP Address</b> : Enter IPv4 or IPv6 format. <b>FQDN</b> : Enter a combination of between 1 and 255 characters using A-Z, a-z, 0-9, "-", and period (.). <b>Email Address</b> : Enter 1 to 255 1-byte ASCII (0x20 to 0x7E) characters. You need to include "@". <b>Key ID</b> : Enter 1 to 255 1-byte ASCII (0x20 to 0x7E) characters.
	Pre-Shared Key	If you select <b>Pre-Shared Key</b> for <b>Authentication Method</b> , enter a pre-shared key between 1 and 127 characters.
	Confirm Pre-Shared Key	Enter the key you configured for confirmation.

**Encapsulation**

If you select **IPsec** for **Access Control**, you need to configure an encapsulation mode.

Items	Settings and Explanation
Transport Mode	If you only use the printer on the same LAN, select this. IP packets of layer 4 or later are encrypted.
Tunnel Mode	If you use the printer on the Internet-capable network such as IPsec-VPN, select this option. The header and data of the IP packets are encrypted. <b>Remote Gateway(Tunnel Mode)</b> : If you select <b>Tunnel Mode</b> for <b>Encapsulation</b> , enter a gateway address between 1 and 39 characters.

**Security Protocol**

If you select **IPsec** for **Access Control**, select an option.

Items	Settings and Explanation
ESP	Select this to ensure the integrity of an authentication and data, and encrypt data.
AH	Select this to ensure the integrity of an authentication and data. Even if encrypting data is prohibited, you can use IPsec.

**Algorithm Settings**

It is recommended that you select **Any** for all settings or select an item other than **Any** for each setting. If you select **Any** for some of the settings and select an item other than **Any** for the other settings, the device may not communicate depending on the other device that you want to authenticate.

Items		Settings and Explanation
IKE	Encryption	Select the encryption algorithm for IKE. The items vary depending on the version of IKE.
	Authentication	Select the authentication algorithm for IKE.
	Key Exchange	Select the key exchange algorithm for IKE. The items vary depending on the version of IKE.
ESP	Encryption	Select the encryption algorithm for ESP. This is available when <b>ESP</b> is selected for <b>Security Protocol</b> .
	Authentication	Select the authentication algorithm for ESP. This is available when <b>ESP</b> is selected for <b>Security Protocol</b> .
AH	Authentication	Select the encryption algorithm for AH. This is available when <b>AH</b> is selected for <b>Security Protocol</b> .

**Related Information**

➔ [“Default Value of the Administrator Password” on page 19](#)

**Configuring Group Policy**

A group policy is one or more rules applied to a user or user group. The printer controls IP packets that match with configured policies. IP packets are authenticated in the order of a group policy 1 to 10 then a default policy.

1. Enter the printer's IP address into a browser to access Web Config.  
Enter the printer's IP address from a computer that is connected to the same network as the printer.  
You can check the IP address of the printer from the following menu.  
**Settings > General Settings > Network Settings > Network Status > Wired LAN/Wi-Fi Status**
2. Enter the administrator password to log in as an administrator.
3. Select in the following order.  
**Network Security tab > IPsec/IP Filtering > Basic**
4. Click a numbered tab you want to configure.
5. Enter a value for each item.
6. Click **Next**.  
A confirmation message is displayed.

7. Click **OK**.

The printer is updated.

**Related Information**

➔ [“Default Value of the Administrator Password” on page 19](#)

**Group Policy Setting Items**

Items	Settings and Explanation
Enable this Group Policy	You can enable or disable a group policy.

**Access Control**

Configure a control method for traffic of IP packets.

Items	Settings and Explanation
Permit Access	Select this to permit configured IP packets to pass through.
Refuse Access	Select this to refuse configured IP packets to pass through.
IPsec	Select this to permit configured IPsec packets to pass through.

**Local Address(Printer)**

Select an IPv4 address or IPv6 address that matches your network environment. If an IP address is assigned automatically, you can select **Use auto-obtained IPv4 address**.

**Note:**

*If an IPv6 address is assigned automatically, the connection may be unavailable. Configure a static IPv6 address.*

**Remote Address(Host)**

Enter a device's IP address to control access. The IP address must be 43 characters or less. If you do not enter an IP address, all addresses are controlled.

**Note:**

*If an IP address is assigned automatically (e.g. assigned by DHCP), the connection may be unavailable. Configure a static IP address.*

**Method of Choosing Port**

Select a method to specify ports.

Service Name

If you select **Service Name** for **Method of Choosing Port**, select an option.

Transport Protocol

If you select **Port Number** for **Method of Choosing Port**, you need to configure an encapsulation mode.

Items	Settings and Explanation
Any Protocol	Select this to control all protocol types.
TCP	Select this to control data for unicast.
UDP	Select this to control data for broadcast and multicast.
ICMPv4	Select this to control ping command.

Local Port

If you select **Port Number** for **Method of Choosing Port** and if you select **TCP** or **UDP** for **Transport Protocol**, enter port numbers to control receiving packets, separating them with commas. You can enter 10 port numbers at the maximum.

Example: 20,80,119,5220

If you do not enter a port number, all ports are controlled.

Remote Port

If you select **Port Number** for **Method of Choosing Port** and if you select **TCP** or **UDP** for **Transport Protocol**, enter port numbers to control sending packets, separating them with commas. You can enter 10 port numbers at the maximum.

Example: 25,80,143,5220

If you do not enter a port number, all ports are controlled.

**IKE Version**

Select **IKEv1** or **IKEv2** for **IKE Version**. Select one of them according to the device that the printer is connected to.

IKEv1

The following items are displayed when you select **IKEv1** for **IKE Version**.

Items	Settings and Explanation
Authentication Method	If you select <b>IPsec</b> for <b>Access Control</b> , select an option. Used certificate is common with a default policy.
Pre-Shared Key	If you select <b>Pre-Shared Key</b> for <b>Authentication Method</b> , enter a pre-shared key between 1 and 127 characters.
Confirm Pre-Shared Key	Enter the key you configured for confirmation.



❑ IKEv2

The following items are displayed when you select **IKEv2** for **IKE Version**.

Items		Settings and Explanation
Local	Authentication Method	If you select <b>IPsec</b> for <b>Access Control</b> , select an option. Used certificate is common with a default policy.
	ID Type	If you select <b>Pre-Shared Key</b> for <b>Authentication Method</b> , select the type of ID for the printer.
	ID	Enter the printer's ID that matches the type of ID. You cannot use "@", "#", and "=" for the first character. <b>Distinguished Name</b> : Enter 1 to 255 1-byte ASCII (0x20 to 0x7E) characters. You need to include "=". <b>IP Address</b> : Enter IPv4 or IPv6 format. <b>FQDN</b> : Enter a combination of between 1 and 255 characters using A-Z, a-z, 0-9, "-", and period (.). <b>Email Address</b> : Enter 1 to 255 1-byte ASCII (0x20 to 0x7E) characters. You need to include "@". <b>Key ID</b> : Enter 1 to 255 1-byte ASCII (0x20 to 0x7E) characters.
	Pre-Shared Key	If you select <b>Pre-Shared Key</b> for <b>Authentication Method</b> , enter a pre-shared key between 1 and 127 characters.
	Confirm Pre-Shared Key	Enter the key you configured for confirmation.
Remote	Authentication Method	If you select <b>IPsec</b> for <b>Access Control</b> , select an option. Used certificate is common with a default policy.
	ID Type	If you select <b>Pre-Shared Key</b> for <b>Authentication Method</b> , select the type of ID for the device that you want to authenticate.
	ID	Enter the printer's ID that matches to the type of ID. You cannot use "@", "#", and "=" for the first character. <b>Distinguished Name</b> : Enter 1 to 255 1-byte ASCII (0x20 to 0x7E) characters. You need to include "=". <b>IP Address</b> : Enter IPv4 or IPv6 format. <b>FQDN</b> : Enter a combination of between 1 and 255 characters using A-Z, a-z, 0-9, "-", and period (.). <b>Email Address</b> : Enter 1 to 255 1-byte ASCII (0x20 to 0x7E) characters. You need to include "@". <b>Key ID</b> : Enter 1 to 255 1-byte ASCII (0x20 to 0x7E) characters.
	Pre-Shared Key	If you select <b>Pre-Shared Key</b> for <b>Authentication Method</b> , enter a pre-shared key between 1 and 127 characters.
	Confirm Pre-Shared Key	Enter the key you configured for confirmation.

**Encapsulation**

If you select **IPsec** for **Access Control**, you need to configure an encapsulation mode.

Items	Settings and Explanation
Transport Mode	If you only use the printer on the same LAN, select this. IP packets of layer 4 or later are encrypted.
Tunnel Mode	If you use the printer on the Internet-capable network such as IPsec-VPN, select this option. The header and data of the IP packets are encrypted.  <b>Remote Gateway(Tunnel Mode):</b> If you select <b>Tunnel Mode</b> for <b>Encapsulation</b> , enter a gateway address between 1 and 39 characters.

### Security Protocol

If you select **IPsec** for **Access Control**, select an option.

Items	Settings and Explanation
ESP	Select this to ensure the integrity of an authentication and data, and encrypt data.
AH	Select this to ensure the integrity of an authentication and data. Even if encrypting data is prohibited, you can use IPsec.

### Algorithm Settings

It is recommended that you select **Any** for all settings or select an item other than **Any** for each setting. If you select **Any** for some of the settings and select an item other than **Any** for the other settings, the device may not communicate depending on the other device that you want to authenticate.

Items	Settings and Explanation
IKE	Encryption Select the encryption algorithm for IKE. The items vary depending on the version of IKE.
	Authentication Select the authentication algorithm for IKE.
	Key Exchange Select the key exchange algorithm for IKE. The items vary depending on the version of IKE.
ESP	Encryption Select the encryption algorithm for ESP. This is available when <b>ESP</b> is selected for <b>Security Protocol</b> .
	Authentication Select the authentication algorithm for ESP. This is available when <b>ESP</b> is selected for <b>Security Protocol</b> .
AH	Authentication Select the encryption algorithm for AH. This is available when <b>AH</b> is selected for <b>Security Protocol</b> .

### Combination of Local Address(Printer) and Remote Address(Host) on Group Policy

	Setting of Local Address(Printer)		
		IPv4	IPv6* <sup>2</sup>

<b>Setting of Remote Address(Host)</b>	IPv4*1	✓	–	✓
	IPv6*1*2	–	✓	✓
	Blank	✓	✓	✓

\*1 : If **IPsec** is selected for **Access Control**, you cannot specify in a prefix length.

\*2 : If **IPsec** is selected for **Access Control**, you can select a link-local address (fe80::) but group policy will be disabled.

\*3 : Except IPv6 link local addresses.

### References of Service Name on Group Policy

**Note:**

Unavailable services are displayed but cannot be selected.

Service Name	Protocol type	Local port number	Remote port number	Features controlled
Any	–	–	–	All services
ENPC	UDP	3289	Any port	Searching for a printer from applications such as Epson Device Admin, a printer driver and the a scanner driver
SNMP	UDP	161	Any port	Acquiring and configuring of MIB from applications such as Epson Device Admin, the Epson printer driver and the Epson scanner driver
LPR	TCP	515	Any port	Forwarding LPR data
RAW (Port9100)	TCP	9100	Any port	Forwarding RAW data
IPP/IPPS	TCP	631	Any port	Forwarding data of IPP/IPPS printing
WSD	TCP	Any port	5357	Controlling WSD
WS-Discovery	UDP	3702	Any port	Searching for a printer from WSD
Network Scan	TCP	1865	Any port	Forwarding scan data from the scanning software
Network Push Scan	TCP	Any port	2968	Acquiring job information of push scanning from the scanning software
Network Push Scan Discovery	UDP	2968	Any port	Searching for a computer when push scanning from the scanning software is executed
FTP Data (Local)	TCP	20	Any port	FTP server (forwarding data of FTP printing)
FTP Control (Local)	TCP	21	Any port	FTP server (controlling FTP printing)

Service Name	Protocol type	Local port number	Remote port number	Features controlled
FTP Data (Remote)	TCP	Any port	20	FTP client (forwarding scan data and received fax data) However this can control only an FTP server that uses remote port number 20.
FTP Control (Remote)	TCP	Any port	21	FTP client (controlling to forward scan data and received fax data)
CIFS (Local)	TCP	445	Any port	CIFS server (Sharing a network folder)
CIFS (Remote)	TCP	Any port	445	CIFS client (forwarding scan data and received fax data to a folder)
NetBIOS Name Service (Local)	UDP	137	Any port	CIFS server (Sharing a network folder)
NetBIOS Datagram Service (Local)	UDP	138	Any port	
NetBIOS Session Service (Local)	TCP	139	Any port	
NetBIOS Name Service (Remote)	UDP	Any port	137	CIFS client (forwarding scan data and received fax data to a folder)
NetBIOS Datagram Service (Remote)	UDP	Any port	138	
NetBIOS Session Service (Remote)	TCP	Any port	139	
HTTP (Local)	TCP	80	Any port	HTTP(S) server (forwarding data of Web Config and WSD)
HTTPS (Local)	TCP	443	Any port	
HTTP (Remote)	TCP	Any port	80	HTTP(S) client (communicating between Epson Connect, firmware updating and root certificate updating)
HTTPS (Remote)	TCP	Any port	443	

## Configuration Examples of IPsec/IP Filtering

### Receiving IPsec packets only

This example is to configure a default policy only.

#### Default Policy:

- IPsec/IP Filtering: Enable**
- Access Control: IPsec**
- Authentication Method: Pre-Shared Key**
- Pre-Shared Key:** Enter up to 127 characters.

**Group Policy:** Do not configure.

### Receiving printing data and printer settings

This example allows communications of printing data and printer configuration from specified services.

**Default Policy:**

- IPsec/IP Filtering: Enable**
- Access Control: Refuse Access**

**Group Policy:**

- Enable this Group Policy:** Check the box.
- Access Control: Permit Access**
- Remote Address(Host):** IP address of a client
- Method of Choosing Port: Service Name**
- Service Name:** Check the box of ENPC, SNMP, HTTP (Local), HTTPS (Local) and RAW (Port9100).

**Note:**

To avoid receiving HTTP (Local) and HTTPS (Local), clear their checkboxes in **Group Policy**. When doing so, disable IPsec/IP filtering from the printer's control panel temporarily to change the printer settings.

### Receiving access from a specified IP address only

This example allows a specified IP address to access the printer.

**Default Policy:**

- IPsec/IP Filtering: Enable**
- Access Control: Refuse Access**

**Group Policy:**

- Enable this Group Policy:** Check the box.
- Access Control: Permit Access**
- Remote Address(Host):** IP address of an administrator's client

**Note:**

Regardless of policy configuration, the client will be able to access and configure the printer.

## Configuring a Certificate for IPsec/IP Filtering

Configure the Client Certificate for IPsec/IP Filtering. When you set it, you can use the certificate as an authentication method for IPsec/IP Filtering. If you want to configure the certification authority, go to **CA Certificate**.

1. Enter the printer's IP address into a browser to access Web Config.  
Enter the printer's IP address from a computer that is connected to the same network as the printer.  
You can check the IP address of the printer from the following menu.  
**Settings > General Settings > Network Settings > Network Status > Wired LAN/Wi-Fi Status**
2. Enter the administrator password to log in as an administrator.

3. Select in the following order.

**Network Security** tab > **IPsec/IP Filtering** > **Client Certificate**

4. Import the certificate in **Client Certificate**.

If you have already imported a certificate published by a Certification Authority, you can copy the certificate and use it in IPsec/IP Filtering. To copy, select the certificate from **Copy From**, and then click **Copy**.

#### **Related Information**

- ➔ [“Default Value of the Administrator Password” on page 19](#)
- ➔ [“Configuring a CA-signed Certificate” on page 446](#)
- ➔ [“Configuring a CA Certificate” on page 451](#)

## **Connecting the Printer to an IEEE802.1X Network**

### **Configuring an IEEE802.1X Network**

When you set IEEE802.1X to the printer, you can use it on the network connected to a RADIUS server, a LAN switch with authentication function, or an access point.

TLS version 1.3 does not support this function.

1. Enter the printer's IP address into a browser to access Web Config.

Enter the printer's IP address from a computer that is connected to the same network as the printer.

You can check the IP address of the printer from the following menu.

**Settings** > **General Settings** > **Network Settings** > **Network Status** > **Wired LAN/Wi-Fi Status**

2. Enter the administrator password to log in as an administrator.

3. Select in the following order.

**Network Security** tab > **IEEE802.1X** > **Basic**

4. Enter a value for each item.

If you want to use the printer on a Wi-Fi network, click **Wi-Fi Setup** and select or enter an SSID.

**Note:**

*You can share settings between Ethernet and Wi-Fi.*

5. Click **Next**.

A confirmation message is displayed.

6. Click **OK**.

The printer is updated.

#### **Related Information**

- ➔ [“Default Value of the Administrator Password” on page 19](#)

### IEEE802.1X Network Setting Items

Items	Settings and Explanation	
IEEE802.1X (Wired LAN)	You can enable or disable settings of the page ( <b>IEEE802.1X &gt; Basic</b> ) for IEEE802.1X (Wired LAN).	
IEEE802.1X (Wi-Fi)	The connection status of IEEE802.1X (Wi-Fi) is displayed.	
Connection Method	The connection method of a current network is displayed.	
EAP Type	Select an option for an authentication method between the printer and a RADIUS server.	
	EAP-TLS	You need to obtain and import a CA-signed certificate.
	PEAP-TLS	
	EAP-TTLS	You need to configure a password.
PEAP/MSCHAPv2		
User ID	Configure an ID to use for an authentication of a RADIUS server. Enter 1 to 128 1-byte ASCII (0x20 to 0x7E) characters.	
Password	Configure a password to authenticate the printer. Enter 1 to 128 1-byte ASCII (0x20 to 0x7E) characters. If you are using a Windows server as a RADIUS server, you can enter up to 127 characters.	
Confirm Password	Enter the password you configured for confirmation.	
Server ID	You can configure a server ID to authenticate with a specified RADIUS server. Authenticator verifies whether a server ID is contained in the subject/subjectAltName field of a server certificate that is sent from a RADIUS server or not. Enter 0 to 128 1-byte ASCII (0x20 to 0x7E) characters.	
Certificate Validation (Wired LAN Only)	You can set certificate validation regardless of the authentication method. Import the certificate in <b>CA Certificate</b> . This item only supports wired LAN connections. A CA Certificate is required to connect to a Wi-Fi network with IEEE8802.1X.	
Anonymous Name	If you select <b>PEAP-TLS</b> , <b>EAP-TTLS</b> or <b>PEAP/MSCHAPv2</b> for <b>EAP Type</b> , you can configure an anonymous name instead of a user ID for a phase 1 of a PEAP authentication. Enter 0 to 128 1-byte ASCII (0x20 to 0x7E) characters.	
Encryption Strength	You can select one of the followings.	
	High	AES256/3DES
	Middle	AES256/3DES/AES128/RC4

#### Related Information

➔ [“Configuring an IEEE802.1X Network” on page 466](#)

## Configuring a Certificate for IEEE802.1X

Configure the Client Certificate for IEEE802.1X. When you set it, you can use **EAP-TLS** and **PEAP-TLS** as an authentication method of IEEE802.1x. If you want to configure the certification authority certificate, go to **CA Certificate**.

1. Enter the printer's IP address into a browser to access Web Config.  
 Enter the printer's IP address from a computer that is connected to the same network as the printer.  
 You can check the IP address of the printer from the following menu.  
**Settings > General Settings > Network Settings > Network Status > Wired LAN/Wi-Fi Status**
2. Enter the administrator password to log in as an administrator.
3. Select in the following order.  
**Network Security tab > IEEE802.1X > Client Certificate**
4. Enter a certificate in the **Client Certificate**.  
 If you have already imported a certificate published by a Certification Authority, you can copy the certificate and use it in IEEE802.1X. To copy, select the certificate from **Copy From**, and then click **Copy**.

### Related Information

- ➔ [“Default Value of the Administrator Password” on page 19](#)
- ➔ [“Configuring a CA-signed Certificate” on page 446](#)
- ➔ [“Configuring a CA Certificate” on page 451](#)

## Checking IEEE802.1X Network Status

You can check the IEEE802.1X status by printing a network status sheet.

Status ID	IEEE802.1X Status
Disable	IEEE802.1X feature is disable.
EAP Success	IEEE802.1X authentication has succeeded and network connection is available.
Authenticating	IEEE802.1X authentication has not been completed.
Config Error	Authentication has failed since the user ID has not been set.
Client Certificate Error	Authentication has failed since the client certificate is out of date.
Timeout Error	Authentication has failed since there is no answer from the RADIUS server and/or authenticator.
User ID Error	Authentication has failed since the printer's user ID and/or certificate protocol is incorrect.
Server ID Error	Authentication has failed since the server ID of the server certificate and the server's ID do not match.



Status ID	IEEE802.1X Status
Server Certificate Error	Authentication has failed since there are the following errors in the server certificate. <ul style="list-style-type: none"> <li><input type="checkbox"/> The server certificate is out of date.</li> <li><input type="checkbox"/> The chain of the server certificate is incorrect.</li> </ul>
CA Certificate Error	Authentication has failed since there are the following errors in a CA certificate. <ul style="list-style-type: none"> <li><input type="checkbox"/> Specified CA certificate is incorrect.</li> <li><input type="checkbox"/> The correct CA certificate is not imported.</li> <li><input type="checkbox"/> CA certificate is out of date.</li> </ul>
EAP Failure	Authentication has failed since there are the following errors in the printer settings. <ul style="list-style-type: none"> <li><input type="checkbox"/> If <b>EAP Type</b> is <b>EAP-TLS</b> or <b>PEAP-TLS</b>, client certificate is incorrect or has certain problems.</li> <li><input type="checkbox"/> If <b>EAP Type</b> is <b>EAP-TTLS</b> or <b>PEAP/MSCHAPv2</b>, user ID or password is not correct.</li> </ul>

**Related Information**

➔ [“Wired LAN/Wi-Fi Status:” on page 367](#)

## Network Security Issues

### Restoring the Security Settings

When you establish a highly secure environment such as IPsec/IP Filtering or IEEE802.1X, you may not be able to communicate with devices because of incorrect settings or trouble with the device or server. In this case, restore the security settings in order to make settings for the device again or to allow you temporary use.

#### ***Disabling the Security Function Using the Control Panel***

You can disable IPsec/IP Filtering or IEEE802.1X using the printer's control panel.

1. Select **Settings > General Settings > Network Settings**.
2. Select **Advanced**.
3. Select from the following items that you want to disable.
  - Disable IPsec/IP Filtering**
  - Disable IEEE802.1X**
4. Select **Start Setup** on the confirmation screen.

## Problems Using Network Security Features

### **Forgot a Pre-shared Key**

#### **Re-configure a pre-shared key.**

To change the key, access Web Config and select the **Network Security** tab > **IPsec/IP Filtering** > **Basic** > **Default Policy** or **Group Policy**.

When you change the pre-shared key, configure the pre-shared key for computers.

#### **Related Information**

- ➔ [“Default Value of the Administrator Password” on page 19](#)
- ➔ [“Encrypted Communication Using IPsec/IP Filtering” on page 454](#)

### **Cannot Communicate with IPsec Communication**

#### **Specify the algorithm that the printer or the computer does not support.**

The printer supports the following algorithms. Check the settings of the computer.

Security Methods	Algorithms
IKE encryption algorithm	AES-CBC-128, AES-CBC-192, AES-CBC-256, AES-GCM-128*, AES-GCM-192*, AES-GCM-256*, 3DES
IKE authentication algorithm	SHA-1, SHA-256, SHA-384, SHA-512, MD5
IKE key exchange algorithm	DH Group1, DH Group2, DH Group5, DH Group14, DH Group15, DH Group16, DH Group17, DH Group18, DH Group19, DH Group20, DH Group21, DH Group22, DH Group23, DH Group24, DH Group25, DH Group26, DH Group27*, DH Group28*, DH Group29*, DH Group30*
ESP encryption algorithm	AES-CBC-128, AES-CBC-192, AES-CBC-256, AES-GCM-128, AES-GCM-192, AES-GCM-256, 3DES
ESP authentication algorithm	SHA-1, SHA-256, SHA-384, SHA-512, MD5
AH authentication algorithm	SHA-1, SHA-256, SHA-384, SHA-512, MD5

\*available for IKEv2 only

#### **Related Information**

- ➔ [“Encrypted Communication Using IPsec/IP Filtering” on page 454](#)

### **Cannot Communicate Suddenly**

#### **The IP address of the printer has been changed or cannot be used.**

When the IP address registered to the local address on Group Policy has been changed or cannot be used, IPsec communication cannot be performed. Disable IPsec using the printer's control panel.

If the DHCP is out of date, rebooting or the IPv6 address is out of date or has not been obtained, then the IP address registered for the printer's Web Config (**Network Security** tab > **IPsec/IP Filtering** > **Basic** > **Group Policy** > **Local Address(Printer)**) may not be found.

Use a static IP address.

**The IP address of the computer has been changed or cannot be used.**

When the IP address registered to the remote address on Group Policy has been changed or cannot be used, IPsec communication cannot be performed.

Disable IPsec using the printer's control panel.

If the DHCP is out of date, rebooting or the IPv6 address is out of date or has not been obtained, then the IP address registered for the printer's Web Config (**Network Security** tab > **IPsec/IP Filtering** > **Basic** > **Group Policy** > **Remote Address(Host)**) may not be found.

Use a static IP address.

**Related Information**

- ➔ [“Default Value of the Administrator Password” on page 19](#)
- ➔ [“Encrypted Communication Using IPsec/IP Filtering” on page 454](#)

***Cannot Create the Secure IPP Printing Port***

**The correct certificate is not specified as the server certificate for SSL/TLS communication.**

If the specified certificate is not correct, creating a port may fail. Make sure you are using the correct certificate.

**The CA certificate is not imported to the computer accessing the printer.**

If a CA certificate is not imported to the computer, creating a port may fail. Make sure a CA certificate is imported.

**Related Information**

- ➔ [“Configuring a Server Certificate for the Printer” on page 453](#)

***Cannot Connect After Configuring IPsec/IP Filtering***

**The settings of IPsec/IP Filtering are incorrect.**

Disable IPsec/IP filtering from the printer's control panel. Connect the printer and computer and make the IPsec/IP Filtering settings again.

**Related Information**

- ➔ [“Encrypted Communication Using IPsec/IP Filtering” on page 454](#)

### ***Cannot Access the Printer after Configuring IEEE802.1X***

#### **The settings of IEEE802.1X are incorrect.**

Disable IEEE802.1X and Wi-Fi from the printer's control panel. Connect the printer and a computer, and then configure IEEE802.1X again.

#### **Related Information**

➔ [“Configuring an IEEE802.1X Network” on page 466](#)

## **Problems on Using a Digital Certificate**

### ***Cannot Import a CA-signed Certificate***

#### **CA-signed Certificate and the information on the CSR do not match.**

If the CA-signed Certificate and CSR do not have the same information, the CSR cannot be imported. Check the following:

- Are you trying to import the certificate to a device that does not have the same information?  
Check the information of the CSR and then import the certificate to a device that has the same information.
- Did you overwrite the CSR saved into the printer after sending the CSR to a certificate authority?  
Obtain the CA-signed certificate again with the CSR.

#### **CA-signed Certificate is more than 5KB.**

You cannot import a CA-signed Certificate that is more than 5KB.

#### **The password for importing the certificate is incorrect.**

Enter the correct password. If you forget the password, you cannot import the certificate. Re-obtain the CA-signed Certificate.

#### **Related Information**

➔ [“Importing a CA-signed Certificate” on page 448](#)

### ***Cannot Update a Self-Signed Certificate***

#### **The Common Name has not been entered.**

**Common Name** must be entered.

#### **Unsupported characters have been entered to Common Name.**

Enter between 1 and 128 characters of either IPv4, IPv6, host name, or FQDN format in ASCII (0x20-0x7E).

#### **A comma or space is included in the common name.**

If a comma is entered, the **Common Name** is divided at that point. If only a space is entered before or after a comma, an error occurs.

**Related Information**

➔ [“Updating a Self-signed Certificate” on page 450](#)

**Cannot Create a CSR**

**The Common Name has not been entered.**

The **Common Name** must be entered.

**Unsupported characters have been entered to Common Name, Organization, Organizational Unit, Locality, and State/Province.**

Enter characters of either IPv4, IPv6, host name, or FQDN format in ASCII (0x20-0x7E).

**A comma or space is included in the Common Name.**

If a comma is entered, the **Common Name** is divided at that point. If only a space is entered before or after a comma, an error occurs.

**Related Information**

➔ [“Obtaining a CA-signed Certificate” on page 446](#)

**Warning Relating to a Digital Certificate Appears**

Messages	Cause/What to do
Enter a Server Certificate.	<p><b>Cause:</b> You have not selected a file to import.</p> <p><b>What to do:</b> Select a file and click <b>Import</b>.</p>
CA Certificate 1 is not entered.	<p><b>Cause:</b> CA certificate 1 is not entered and only CA certificate 2 is entered.</p> <p><b>What to do:</b> Import CA certificate 1 first.</p>
Invalid value below.	<p><b>Cause:</b> Unsupported characters are contained in the file path and/or password.</p> <p><b>What to do:</b> Make sure that the characters are entered correctly for the item.</p>
Invalid date and time.	<p><b>Cause:</b> Date and time for the printer have not been set.</p> <p><b>What to do:</b> Set date and time using Web Config, EpsonNet Config or the printer's control panel.</p>

Messages	Cause/What to do
Invalid password.	<p><b>Cause:</b> The password set for CA certificate and entered password do not match.</p> <p><b>What to do:</b> Enter the correct password.</p>
Invalid file.	<p><b>Cause:</b> You are not importing a certificate file in X509 format.</p> <p><b>What to do:</b> Make sure that you are selecting the correct certificate sent by a trusted certificate authority.</p>
	<p><b>Cause:</b> The file you have imported is too large. The maximum file size is 5KB.</p> <p><b>What to do:</b> If you select the correct file, the certificate might be corrupted or fabricated.</p>
	<p><b>Cause:</b> The chain contained in the certificate is invalid.</p> <p><b>What to do:</b> For more information on the certificate, see the website of the certificate authority.</p>
Cannot use the Server Certificates that include more than three CA certificates.	<p><b>Cause:</b> The certificate file in PKCS#12 format contains more than 3 CA certificates.</p> <p><b>What to do:</b> Import each certificate as converting from PKCS#12 format to PEM format, or import the certificate file in PKCS#12 format that contains up to 2 CA certificates.</p>
The certificate has expired. Check if the certificate is valid, or check the date and time on your printer.	<p><b>Cause:</b> The certificate is out of date.</p> <p><b>What to do:</b></p> <ul style="list-style-type: none"> <li><input type="checkbox"/> If the certificate is out of date, obtain and import the new certificate.</li> <li><input type="checkbox"/> If the certificate is not out of date, make sure the printer's date and time are set correctly.</li> </ul>

Messages	Cause/What to do
Private key is required.	<p><b>Cause:</b> There is no paired private key with the certificate.</p> <p><b>What to do:</b></p> <ul style="list-style-type: none"> <li><input type="checkbox"/> If the certificate is the PEM/DER format and it is obtained from a CSR using a computer, specify the private key file.</li> <li><input type="checkbox"/> If the certificate is the PKCS#12 format and it is obtained from a CSR using a computer, create a file that contains the private key.</li> </ul> <hr/> <p><b>Cause:</b> You have re-imported the PEM/DER certificate obtained from a CSR using Web Config.</p> <p><b>What to do:</b> If the certificate is the PEM/DER format and it is obtained from a CSR using Web Config, you can only import it once.</p>
Setup failed.	<p><b>Cause:</b> Cannot finish the configuration because the communication between the printer and computer failed or the file cannot be read by some errors.</p> <p><b>What to do:</b> After checking the specified file and communication, import the file again.</p>

**Related Information**

➔ [“About Digital Certification” on page 445](#)

**Delete a CA-signed Certificate by Mistake**

**There is no backup file for the CA-signed certificate.**

If you have the backup file, import the certificate again.

If you obtain a certificate using a CSR created from Web Config, you cannot import a deleted certificate again. Create a CSR and obtain a new certificate.

**Related Information**

➔ [“Importing a CA-signed Certificate” on page 448](#)

➔ [“Deleting a CA-signed Certificate” on page 449](#)

---

# Using Epson Open Platform

## Epson Open Platform Overview

Epson Open Platform is a platform to use Epson printers with the function provided by the server of the authentication system.

You can acquire the logs of each device and user in cooperation with the server, and configure restrictions on the device and functions that can be used for each user and group. It can be used with Epson Print Admin (Epson Authentication System) or a third-party authentication system.

If you connect an authentication device, you can also perform user authentication using the ID card.

### Related Information

➔ [“Epson Authentication System \(Epson Print Admin\)” on page 357](#)

## Configuring Epson Open Platform

Enable Epson Open Platform so that you can use the device from the authentication system.

1. Enter the printer's IP address into a browser to access Web Config.  
Enter the printer's IP address from a computer that is connected to the same network as the printer.  
You can check the IP address of the printer from the following menu.  
**Settings > General Settings > Network Settings > Network Status > Wired LAN/Wi-Fi Status**
2. Enter the administrator password to log in as an administrator.
3. Select in the following order.  
**Epson Open Platform tab > Product Key or License Key**
4. Enter a value for each item.
  - Serial Number  
The serial number of the device is displayed.
  - Epson Open Platform Version  
Select the version of Epson Open Platform. The corresponding version varies depending on the authentication system.
  - Product Key or License Key  
Enter the product key obtained from the dedicated Web site. See the Epson Open Platform manual for details such as how to obtain the product key.
5. Click **Next**.  
A confirmation message is displayed.
6. Click **OK**.  
The printer is updated.

### Related Information

➔ [“Default Value of the Administrator Password” on page 19](#)

## Validating of Epson Open Platform

You can check the validity of Epson Open Platform using any of the following methods.



Web Config

A product key has been entered in the **Epson Open Platform** tab > **Product Key or License Key** > **Product Key or License Key**, and the **Epson Open Platform** tab > **Authentication System** is displayed on the left of the menu tree.

Printer's control panel

A product key is displayed in Home screen > **Settings** > **Epson Open Platform Information**.

---

## **Epson Remote Services Information**

Epson Remote Services is a service that periodically collects printer information over the Internet. This can be used to predict when consumables and replacement parts need to be replaced or replenished, and to quickly resolve any errors or problems.

Contact your sales representative for more information about Epson Remote Services.

---

# Where to Get Help

Technical Support Web Site. . . . .	479
Contacting Epson Support. . . . .	479

---

## Technical Support Web Site

If you need further help, visit the Epson support website shown below. Select your country or region and go to the support section of your local Epson website. The latest drivers, FAQs, manuals, or other downloadables are also available from the site.

<http://support.epson.net/>

<http://www.epson.eu/support> (Europe)

If your Epson product is not operating properly and you cannot solve the problem, contact Epson support services for assistance.

---

## Contacting Epson Support

### Before Contacting Epson

If your Epson product is not operating properly and you cannot solve the problem using the troubleshooting information in your product manuals, contact Epson support services for assistance.

The following Epson support list is based on the country of sale. Some products may not be sold in your current location, so be sure to contact Epson support for the area in which you purchased your product.

If Epson support for your area is not listed below, contact the dealer where you purchased your product.

Epson support will be able to help you much more quickly if you give them the following information:

- Product serial number

(The label attachment position depends on the product; it may be on the back, the open side of the cover, or the bottom.)

- Product model

- Product software version

(Click **About**, **Version Info**, or a similar button in the product software.)

- Brand and model of your computer

- Your computer operating system name and version

- Names and versions of the software applications you normally use with your product

**Note:**

*Depending on the product, the dial list data for fax and/or network settings may be stored in the product's memory. Due to breakdown or repair of a product, data and/or settings may be lost. Epson shall not be responsible for the loss of any data, for backing up or recovering data and/or settings even during a warranty period. We recommend that you make your own backup data or take notes.*

### Help for Users in Europe

Check your Pan-European Warranty Document for information on how to contact Epson support.

## Help for Users in Taiwan

Contacts for information, support, and services are:

### World Wide Web

<http://www.epson.com.tw>

Information on product specifications, drivers for download, and products enquiry are available.

### Epson HelpDesk

Phone: +886-2-2165-3138

Our HelpDesk team can help you with the following over the phone:

- Sales enquiries and product information
- Product usage questions or problems
- Enquiries on repair service and warranty

### Repair service center:

<http://www.tekcare.com.tw/branchMap.page>

TekCare corporation is an authorized service center for Epson Taiwan Technology & Trading Ltd.

## Help for Users in Australia

Epson Australia wishes to provide you with a high level of customer service. In addition to your product manuals, we provide the following sources for obtaining information:

### Internet URL

<http://www.epson.com.au>

Access the Epson Australia World Wide Web pages. Worth taking your modem here for the occasional surf! The site provides a download area for drivers, Epson contact points, new product information and technical support (e-mail).

### Epson Helpdesk

Phone: 1300-361-054

Epson Helpdesk is provided as a final backup to make sure our clients have access to advice. Operators on the Helpdesk can aid you in installing, configuring and operating your Epson product. Our Pre-sales Helpdesk staff can provide literature on new Epson products and advise where the nearest dealer or service agent is located. Many types of queries are answered here.

We encourage you to have all the relevant information on hand when you ring. The more information you prepare, the faster we can help solve the problem. This information includes your Epson product manuals, type of computer, operating system, application programs, and any information you feel is required.

### Transportation of Product

Epson recommends retaining product packaging for future transportation.

## Help for Users in New Zealand

Epson New Zealand wishes to provide you with a high level of customer service. In addition to your product documentation, we provide the following sources for obtaining information:

### Internet URL

<http://www.epson.co.nz>

Access the Epson New Zealand World Wide Web pages. Worth taking your modem here for the occasional surf! The site provides a download area for drivers, Epson contact points, new product information and technical support (e-mail).

### Epson Helpdesk

Phone: 0800 237 766

Epson Helpdesk is provided as a final backup to make sure our clients have access to advice. Operators on the Helpdesk can aid you in installing, configuring and operating your Epson product. Our Pre-sales Helpdesk staff can provide literature on new Epson products and advise where the nearest dealer or service agent is located. Many types of queries are answered here.

We encourage you to have all the relevant information on hand when you ring. The more information you prepare, the faster we can help solve the problem. This information includes your Epson product documentation, type of computer, operating system, application programs, and any information you feel is required.

### Transportation of Product

Epson recommends retaining product packaging for future transportation.

## Help for Users in Singapore

Sources of information, support, and services available from Epson Singapore are:

### World Wide Web

<http://www.epson.com.sg>

Information on product specifications, drivers for download, Frequently Asked Questions (FAQ), Sales Enquiries, and Technical Support via e-mail are available.

### Epson HelpDesk

Toll Free: 800-120-5564

Our HelpDesk team can help you with the following over the phone:

- Sales enquiries and product information
- Product usage questions or problem troubleshooting
- Enquiries on repair service and warranty

## Help for Users in Thailand

Contacts for information, support, and services are:

### **World Wide Web**

<http://www.epson.co.th>

Information on product specifications, drivers for download, Frequently Asked Questions (FAQ), and e-mail are available.

### **Epson Call Centre**

Phone: 66-2460-9699

Email: support@eth.epson.co.th

Our Call Centre team can help you with the following over the phone:

- Sales enquiries and product information
- Product usage questions or problems
- Enquiries on repair service and warranty

## **Help for Users in Vietnam**

Contacts for information, support, and services are:

### **Epson Service Center**

27 Yen Lang, Trung Liet Ward, Dong Da District, Ha Noi City. Tel: +84 24 7300 0911

38 Le Dinh Ly, Thac Gian Ward, Thanh Khe District, Da Nang. Tel: +84 23 6356 2666

194/3 Nguyen Trong Tuyen, Ward 8, Phu Nhuan Dist., HCMC. Tel: +84 28 7300 0911

31 Phan Boi Chau, Ward 14, Binh Thanh District, HCMC. Tel: +84 28 35100818

## **Help for Users in Indonesia**

Contacts for information, support, and services are:

### **World Wide Web**

<http://www.epson.co.id>

- Information on product specifications, drivers for download
- Frequently Asked Questions (FAQ), Sales Enquiries, questions through e-mail

### **Epson Hotline**

Phone: 1500-766 (Indonesia Only)

Email: customer.care@ein.epson.co.id

Our Hotline team can help you with the following over the phone or email:

- Sales enquiries and product information
- Technical support

## Help for Users in Hong Kong

To obtain technical support as well as other after-sales services, users are welcome to contact Epson Hong Kong Limited.

### Internet Home Page

<http://www.epson.com.hk>

Epson Hong Kong has established a local home page in both Chinese and English on the Internet to provide users with the following information:

- Product information
- Answers to Frequently Asked Questions (FAQs)
- Latest versions of Epson product drivers

### Technical Support Hotline

You can also contact our technical staff at the following telephone and fax numbers:

Phone: 852-2827-8911

Fax: 852-2827-4383

## Help for Users in Malaysia

Contacts for information, support, and services are:

### World Wide Web

<http://www.epson.com.my>

- Information on product specifications, drivers for download
- Frequently Asked Questions (FAQ), Sales Enquiries, questions through e-mail

### Epson Call Centre

Phone: 1800-81-7349 (Toll Free)

Email: [websupport@emsb.epson.com.my](mailto:websupport@emsb.epson.com.my)

- Sales enquiries and product information
- Product usage questions or problems
- Enquiries on repair services and warranty

### Epson Malaysia Sdn Bhd (Head Office)

Phone: 603-56288288

Fax: 603-5628 8388/603-5621 2088

## Help for Users in India

Contacts for information, support, and services are:

### **World Wide Web**

<http://www.epson.co.in>

Information on product specifications, drivers for download, and products enquiry are available.

### **Toll Free Helpline**

For Service, Product information or to order consumables -

18004250011 / 186030001600 / 1800123001600 (9AM – 6PM)

### **Email**

[calllog@epson-india.in](mailto:calllog@epson-india.in)

### **WhatsApp**

+91 96400 00333

## **Help for Users in the Philippines**

To obtain technical support as well as other after sales services, users are welcome to contact the Epson Philippines Corporation at the telephone, fax numbers and e-mail address below:

### **World Wide Web**

<http://www.epson.com.ph>

Information on product specifications, drivers for download, Frequently Asked Questions (FAQ), and E-mail Enquiries are available.

### **Epson Philippines Customer Care**

Toll Free: (PLDT) 1-800-1069-37766

Toll Free: (Digitel) 1-800-3-0037766

Metro Manila: +632-8441-9030

Web Site: <https://www.epson.com.ph/contact>

E-mail: [customercare@epc.epson.com.ph](mailto:customercare@epc.epson.com.ph)

Accessible 9am to 6pm, Monday through Saturday (Except public holidays)

Our Customer Care team can help you with the following over the phone:

- Sales enquiries and product information
- Product usage questions or problems
- Enquiries on repair service and warranty

### **Epson Philippines Corporation**

Trunk Line: +632-8706-2609

Fax: +632-8706-2663 / +632-8706-2665