



GA241

Cooler Master 23.8" Gaming Monitor

User Manual

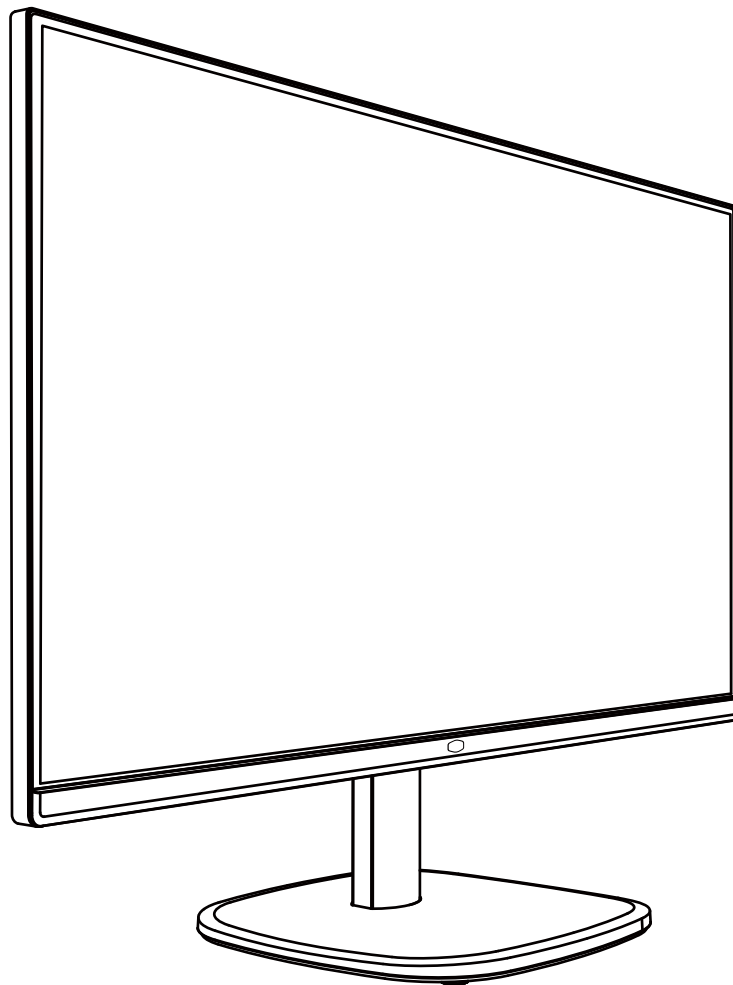

Table of Contents

Requirements and Safety Notice	1
Important Safety Instructions	3
Package Contents	4
Installing the Monitor Arm/Base	5
Adjusting the Monitor	7
Wall Mount Installation Instructions	8
External Control Buttons	9
Main Menu	10
Picture.....	10
Color.....	11
Audio.....	11
Gaming.....	13
OSD.....	12
System.....	13
Information.....	14
Specifications	15
Supported Timing	16
PC Timing.....	16
Video Timing	17
Product Outline Dimensions	18

Requirements and Safety Notice

FCC Safety Notice

This product has been tested and determined to be meeting the limits for a Class B digital device and in compliance with Part 15 of the FCC Regulations. These requirements are set to reasonably protect the home installation environment from hazardous interference. This product will generate, use and emit radio frequency energy. Failure to install and use it as instructed may cause hazardous interference to radio communication. However, we cannot guarantee zero interference for certain installation methods. If this product has caused hazardous interference to radio or TV reception (turn on or turn off this product to for confirmation), the user may try to make adjustment with the following methods:

- Re-adjust the angle and position of the reception antenna.
- Increase the distance between the device and receiver.
- Do not use the power sockets of the device and receiver together.
- If assistance is needed, contact the distributor or a professional radio/TV technician.

CE Compliance Statement

Cooler Master Technology Inc. hereby declares that the monitor conforms to the following key standards and other related provisions:

EMC Directive 2014/30/EU, Low Voltage Directive 2014/35/EU, RoHS Directive 2011/65/EU and Directive 2009/125/EC establishing a framework for the setting of eco-design requirements for energy-related products.

Note:

To prevent damage of the monitor, do not lift the monitor from the support base.

Note: Shielded cable

To comply with the EMC requirements, a shielded cable must be used for connection between this product and any other computer device.

Note:

The monitor is exclusively used in the video and image display of information acquired from electronic devices.

Note: Peripherals

Only a peripheral device (I/O device, terminal, printer, etc.) that has been certified and met the Class B limits can be sold together with this product. If this product is used together with any other uncertified peripheral device, it may cause interference to radio and TV reception.

Warning

Any change or modification not approved by the original manufacturer may lead to the user losing the right to operate this product. Such authorization is given by the Federal Communications Commission.

Requirements for Use

This product meets the limits under Part 15 of the FCC Regulations. When operating this product, please meet the following two requirements: (1) This product may not generate hazardous interference; and (2) This product must accept any interference signal received, including interference that is likely to lead to unexpected operation.

The following local Manufacturer/Importer is responsible for this declaration.

<p>Product Name:LCD Monitor Model No:GA241 Company Name:North America - CMI USA, Inc. Address:1 N Indian Hill Blvd Suite 200, Claremont, CA 91711, USA Contact Person: Cooler Master Representative Phone No: +1-888-624-5099</p>

Note: Canadian users

This Class B digital device complies with Canadian ICES-003 specifications.

Remarque à l'intention des utilisateurs canadiens

Cet appareil numérique de la classe B est conforme à la norme NMB-003 du Canada

Disposal of Waste Equipment by Home Users in EU



If this symbol appears on a product and its package, it indicates that the product cannot be disposed of together with other household waste. You have to deliver the waste equipment to a designated recycling center for recycling of waste electrical and electronic equipment. Proper sorting and recycling of resources during the disposal of waste equipment is helpful for protecting natural resources and ensuring that resource recycling can protect human health and environment. For detailed information about recycling centers where waste equipment is disposed of, contact the local municipal office, cleaning service or the store where the purchased product is found.

电子电气产品有害物质限制使用标识要求

本产品有害物质的名称及含量标识如下表：

部件名称	有害物质					
	铅 (Pb)	汞 (Hg)	镉 (Cd)	六价铬 (Cr (VI))	多溴联苯 (PBB)	多溴联苯醚 (PBDE)
外壳	○	○	○	○	○	○
电路板组件*	×	○	○	○	○	○
电源线/适配器	×	○	○	○	○	○
外部信号连接线	×	○	○	○	○	○
液晶面板	×	○	○	○	○	○

本表格依据 SJ/T 11364 的规定编制。

*：电路板组件包括印刷电路板及其构成的零部件，如电阻、电容、集成电路、连接器等

○：表示该有害物质在该部件所有均质材料中的含量均在 GB/T26572 规定的限量要求以下。

×：表示该有害物质至少在该部件的某一均质材料中的含量超出 GB/T26572 规定的限量要求。

限用物質含有情況標示聲明書

單元 Unit	限用物質及其化學符號 Restricted substances and its chemical symbols					
	鉛Lead (Pb)	汞Mercury (Hg)	鎘Cadmium (Cd)	六價鉻Hexavalent chromium (Cr ⁺⁶)	多溴聯苯Polybrominated biphenyls (PBB)	多溴二苯醚Polybrominated diphenyl ethers (PBDE)
支架/外殼	○	○	○	○	○	○
印刷電路板	—	○	○	○	○	○
玻璃面板	—	○	○	○	○	○
電纜/電線/連接線	—	○	○	○	○	○
電源設備/外接電源供應器	—	○	○	○	○	○

備考1. “超出0.1 wt %” 及 “超出0.01 wt %” 係指限用物質之百分比含量超出百分比含量基準值。

備考2. “○” 係指該項限用物質之百分比含量未超出百分比含量基準值。

備考3. “—” 係指該項限用物質為排除項目。

Important Safety Instructions

Please read the following instructions carefully.

1. To clean the LCD monitor screen:

Turn off the LCD monitor and unplug the power cord.

Spray a non-solvent cleaning solution onto a rag and clean the screen gently.

2. Do not place the LCD monitor near a window. Exposing the monitor to rain, moisture or sunlight can severely damage it.

3. Do not apply pressure to the LCD screen. Excessive pressure may cause permanent damage to the display.

4. Do not remove the cover or attempt to service this unit yourself.

An authorized technician should perform servicing of any nature

5. Store the LCD monitor in a room with a temperature of -20° to 60° C (-4° to 140° F). Storing the LCD monitor outside this range may result in permanent damage.

6. Immediately unplug your monitor and call an authorized technician if any of the following circumstances occur:

- Monitor to PC signal cable is frayed or damaged.
- Liquid spills onto the LCD monitor or the monitor is exposed to rain.
- The LCD monitor or case is damaged.

Package Contents

A

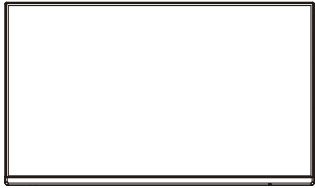

Monitor

B

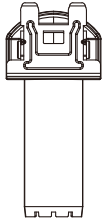

Support stand

C

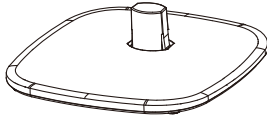

Support base

D

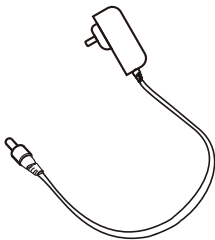

Power adapter

E

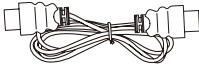

HDMI cable (Optional)

Installing the Monitor Arm/Base

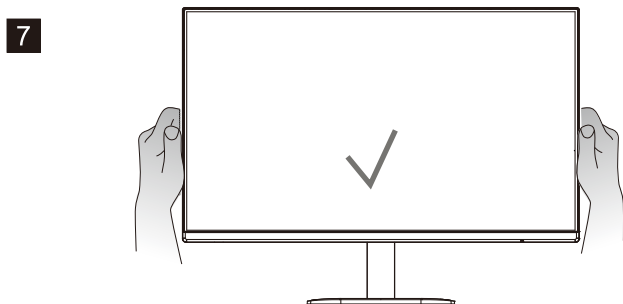
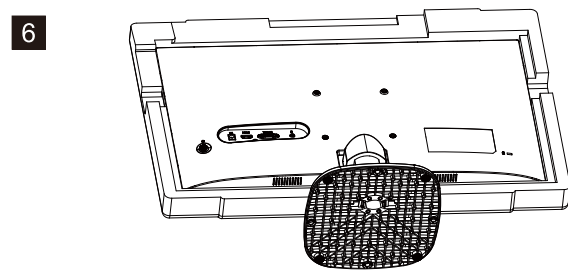
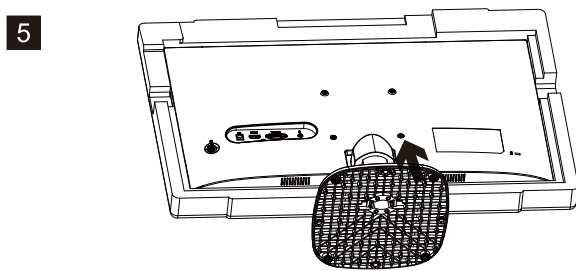
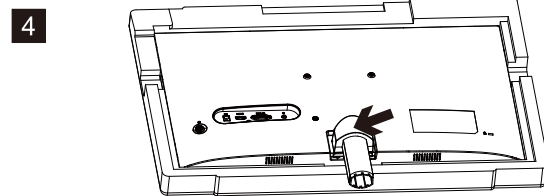
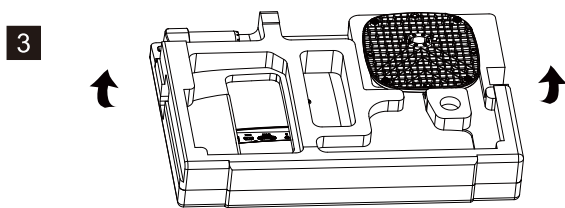
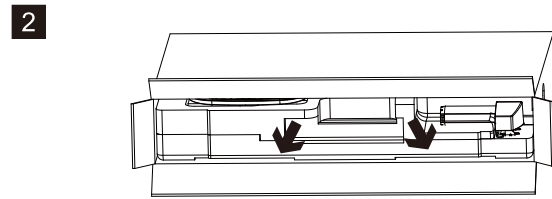
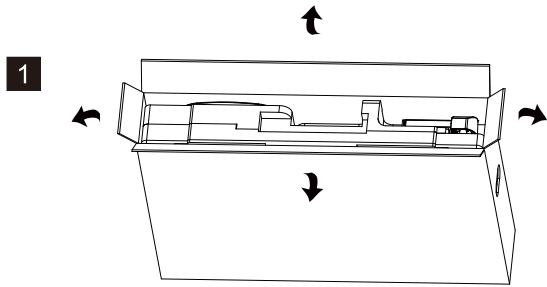

8

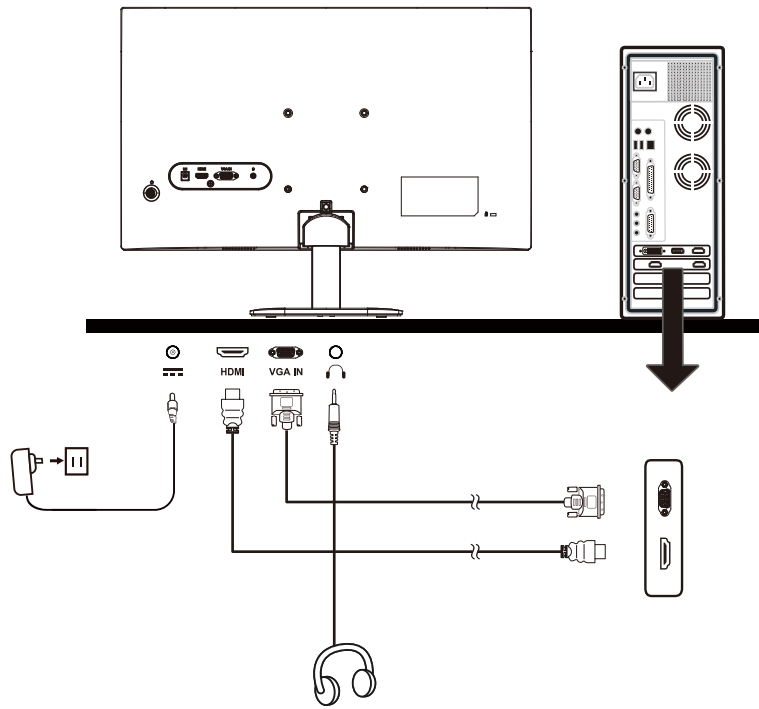

9

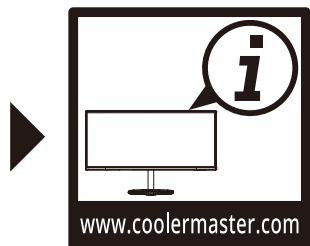
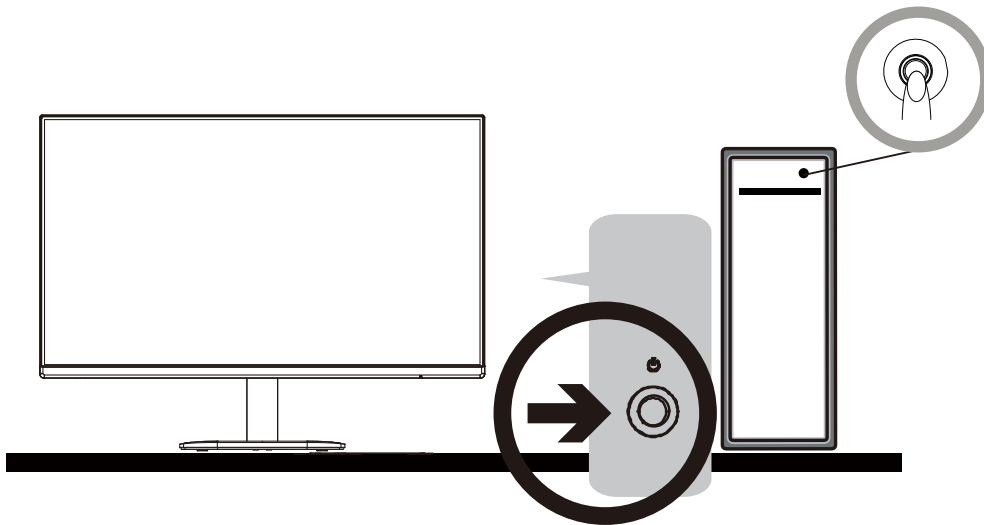

Adjusting the Monitor

- For the best results, it is recommended to look directly at the front of the monitor and make any adjusts as necessary.
- Ensure that the monitor is mounted upright on the stand base.
- When adjusting the monitor viewing angles, avoid touching the screen and hold the stand in order to prevent it from falling over.

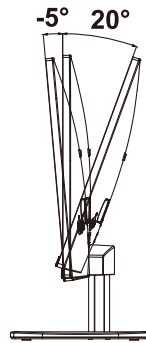

Wall Mount Installation Instructions

1

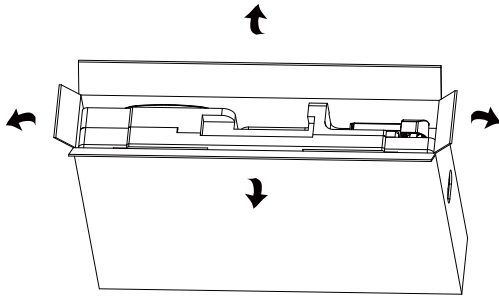

2

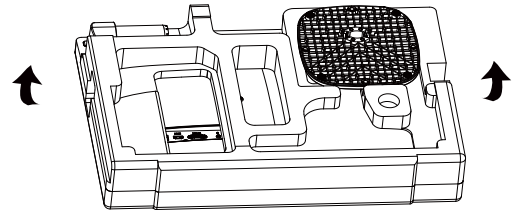

3

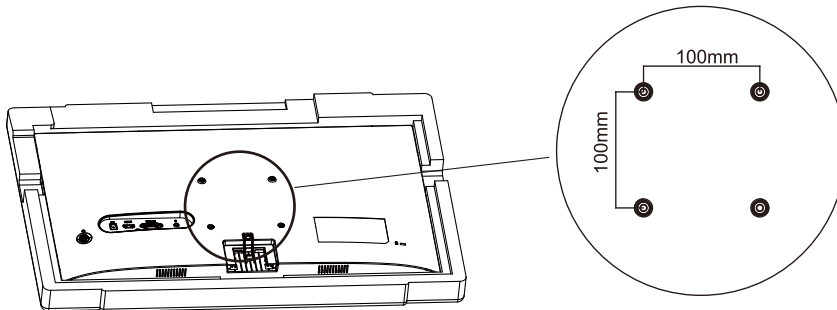

VESA : 100 x 100 mm

Screws : M4 x 10 mm

4

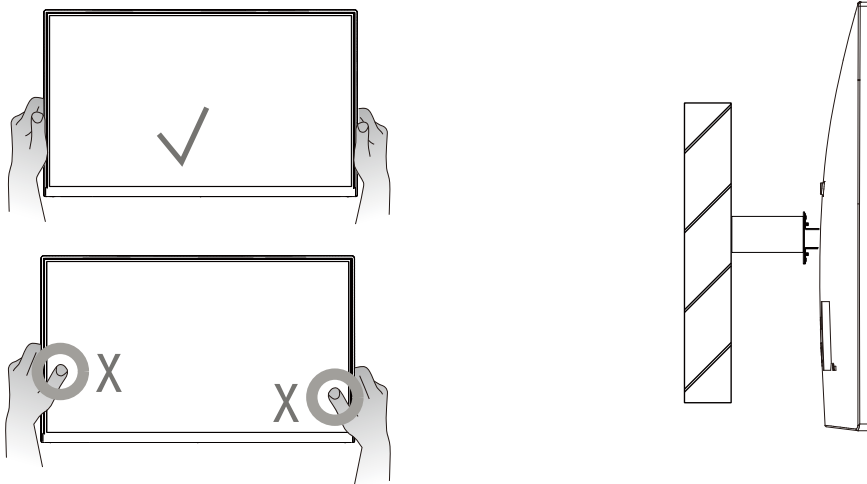

External Control Buttons

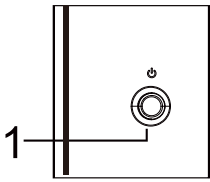

① Menu/Navi/OK button

Short press to turn on the monitor and Long press to turn off.

When the OSD menu is activated, pull up/down/left/right the button to adjust the settings you need. When finished, you can pull the Button Back to return to the previous level or use the Button Exit to close the OSD menu.

NOTE: Power light;

Blue = ON;

Orange = Power Saving.

Main Menu

【Picture】

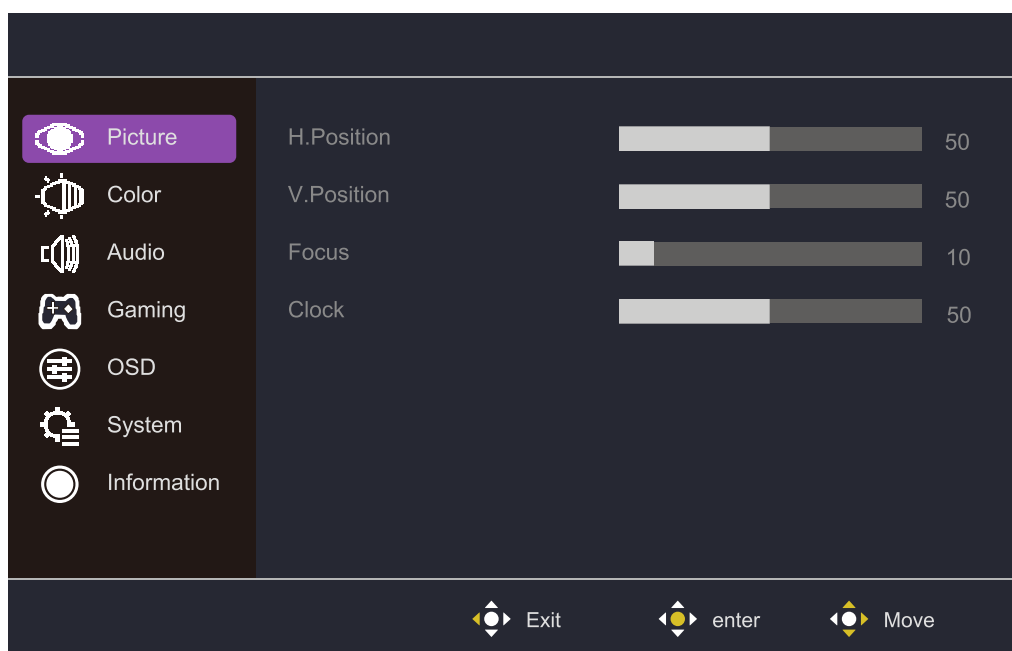
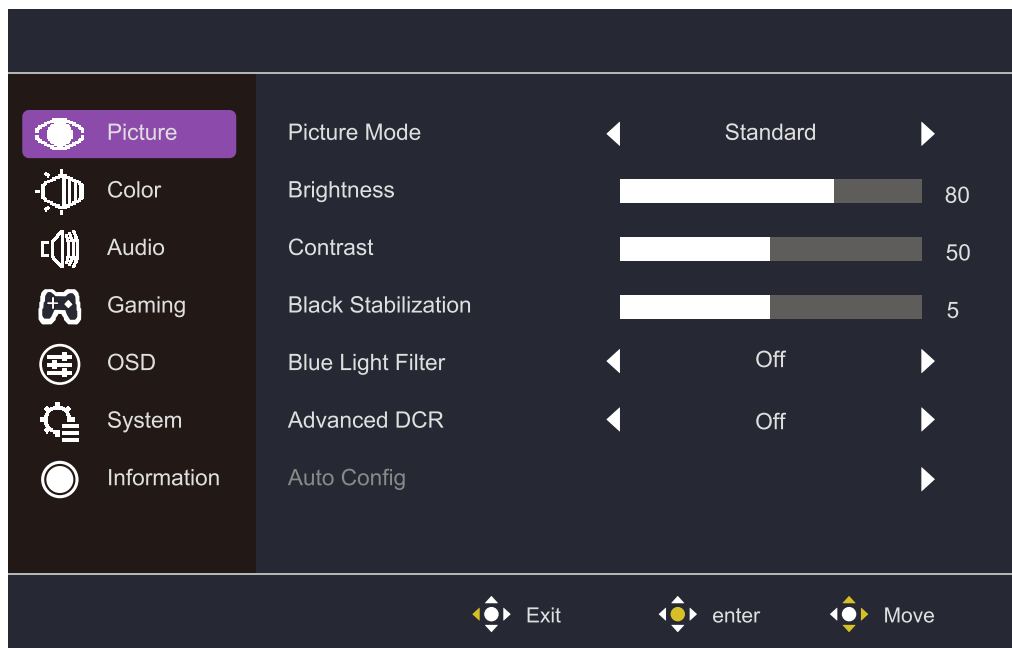

- Enter the Picture menu to configure image setting.
 - **Picture Mode:** Enter the Picture Setting menu to adjust different picture modes.
 - a. **Act:** Provide the optimized setting for Act(Action) games.
 - b. **FPS:** Provide the optimized setting for FPS(First Person Shooting) games to increase the visibility in dark scenes.
 - c. **RTS:** Provide the optimized setting for RTS(Real-Time Strategy) games.
 - d. **User:** Provide customized option for user experience.
 - e. **Standard:** Enable standard picture mode.
 - f. **Web:** Provide the optimized setting for website browsing experience.
 - g. **Text:** Provide the optimized setting for reading(Native color space: sRGB).
 - h. **Movie:** Provide the optimized setting for movie watching experience.
 - **Brightness:** Adjust the backlight brightness level between 0 and 100.
 - **Contrast :** Adjust the Contrast level between 0 and 100.

- **Black Stabilization:** Adjust the backlight brightness level between 0 and 100.
- **Blue Light Filter :** Adjust the Contrast level between 0 and 100.
- **Advanced DCR:** Turn the Advanced DCR function On or Off.
- **Auto Config :** Automatic adjustment screen.
- **H.Position:** Adjust the horizontal position between 0 to 100.
- **V.Position:** Adjust the vertical position between 0 to 100.
- **Focus:** Adjust the Focus between 0 and 100.
- **Clock :** Adjust the Clock between 0 and 100.

【Color】



- Enter the Color menu to adjust the ideal color mode.
 - **Gamma:** Adjust gamma curve between 1.8, 2.2 and 2.4.
 - **Color Temperature:** Adjust between Bluish, Cool, Native, Warm and User Color settings which can adjust Red, Green and Blue value from 0 to 100.

【Audio】

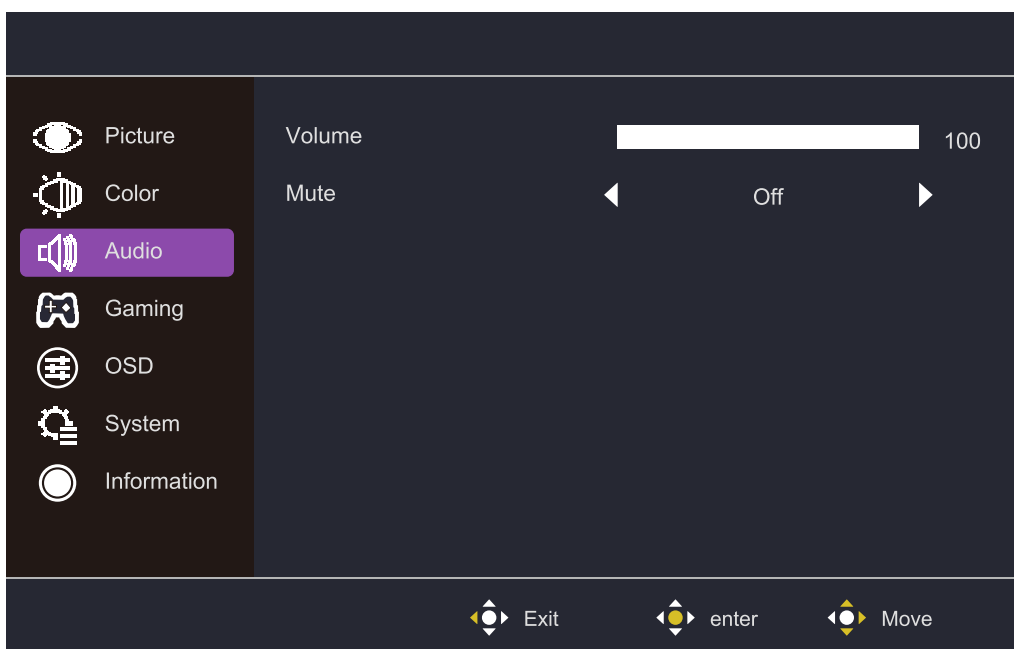

- Enter the Audio menu to adjust functions including Mute and Volume functions etc.
 - **Volume:** Adjust the volume value between 0 and 100.
 - **Mute:** Enable or disable the mute function.
 - *Adjust volume value level properly to avoid damaging hearing.

【Gaming】

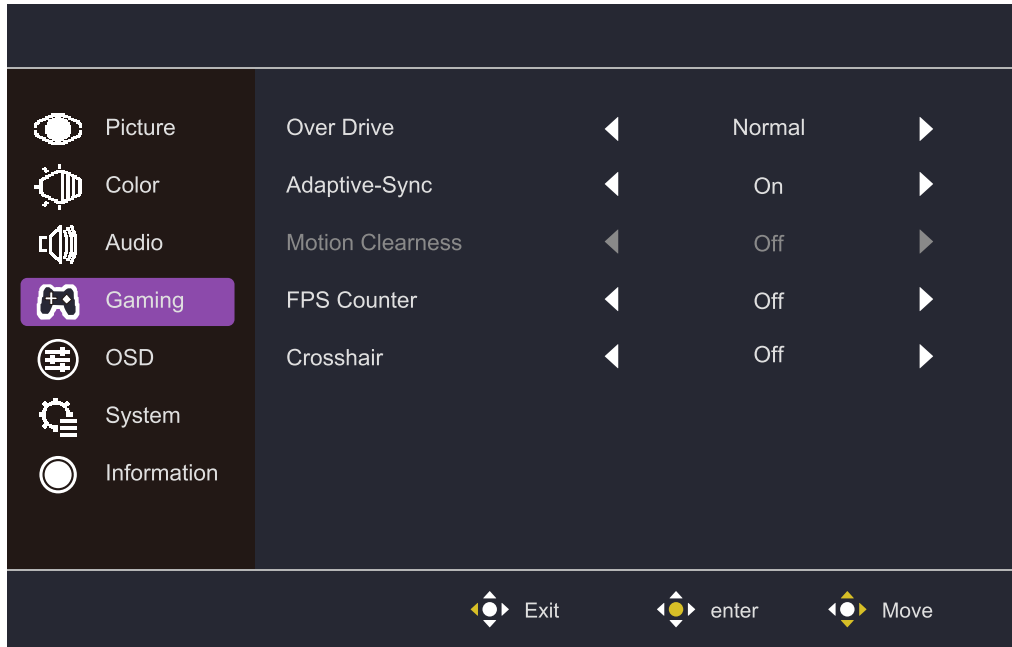

- Go to the Gaming menu to adjust the desired Gaming mode.
 - **Over Drive:** Off, Normal, Advanced modes are available options for speeding up the response time.
 - **Adaptive-Sync:** Turn the Adaptive-Sync function On or Off.
 - *Enabling Adaptive-Sync may cause side effects like flicker due to the fluctuation of the output frequency from graphics cards.
 - **Motion Clearness:** MPRT setting with: Off or On as available options.
 - **FPS Counter:** Turn the FPS Counter function On or Off.
 - **Crosshair:** Off, Icon1, Icon2, Icon3 are available options turn the Crosshair position off or adjust it.

【OSD】

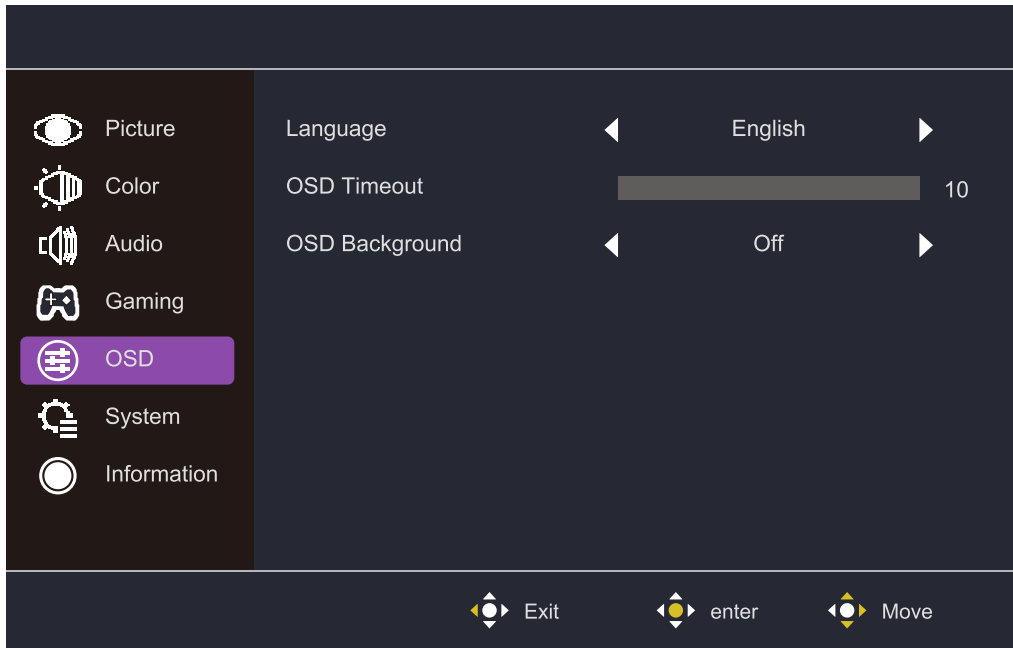

- **Language:** English, Russian, German, French, Spanish, Italian, Finnish, Traditional Chinese, Simplified Chinese, Japanese, Korean are available options.
- **OSD Timeout:** Adjust the OSD Timeout setting value between 10 and 120.
- **OSD Background:** Turn the OSD Background setting value between Off, 20%, 40%, 60% and 80%.

【System】

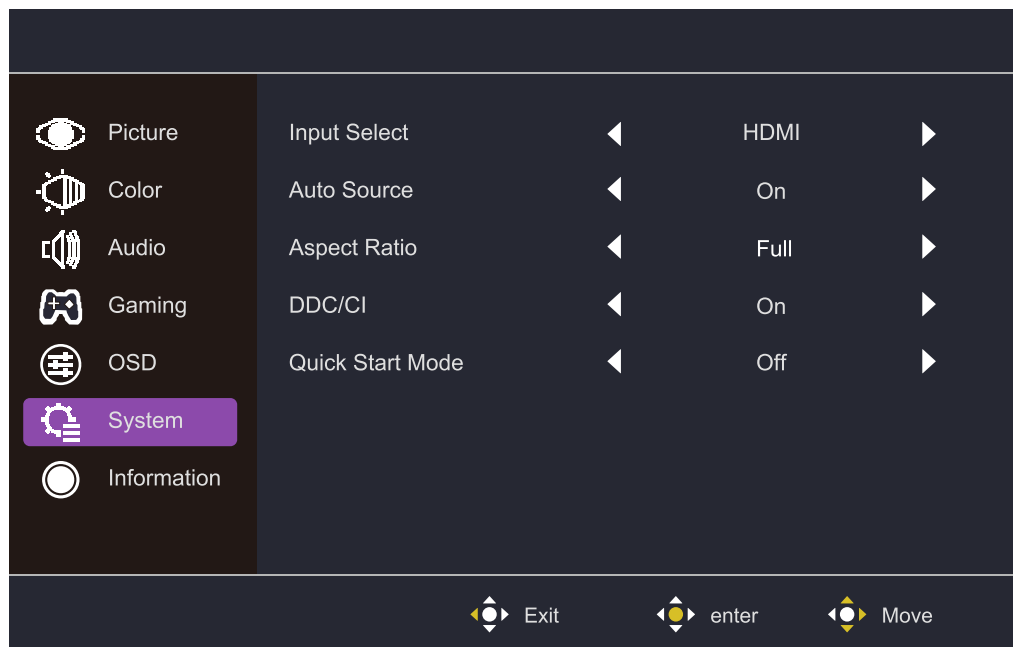

- **Input Select:** Select the source from an available input source, including VGA and HDMI.
- **Auto Source:** Automatically searches for available input sources.
- **Aspect Ratio:** Full Screen and Aspect Screen mode can be selected.
- **DDC/CI:** Turn the DDC/CI function On or Off.
- **Quick Start Mode:** Turn the Quick Start Mode function On or Off.

【Information】

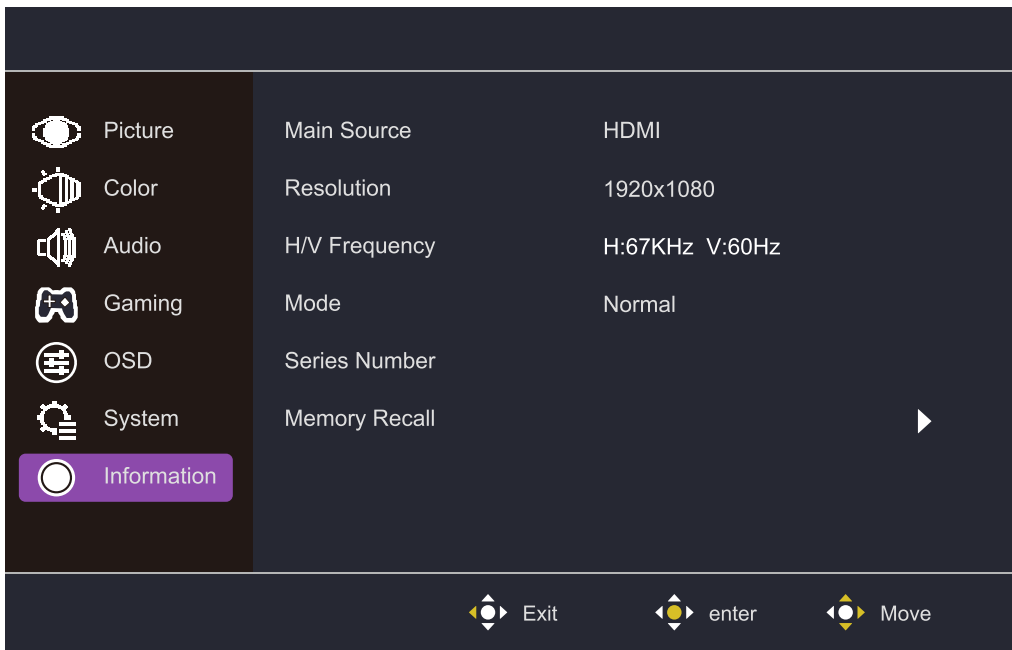

- **Information:** View the basic information of the model including Main Source, Resolution, H/V Frequency, Mode and Series Number setting.
- **Memory Recall:** Restore the Settings back to default values.

Specifications

LCD panel	Size	23.8"
	Pixel pitch	0.2745(H) x 0.2745(V)mm
	Brightness	250nits(Typ.)
	Contrast	4000:1(Typ.)
	Viewing angle	178°(Horizontal)178°(Vertical)
	Response time	1ms MPRT (motion clearness on)
Display colors		16.7 million colors
Max. display frequency (Resolution H*V/Fv)		1920*1080 @ 75 Hz(D-Sub) 1920*1080 @ 100 Hz(HDMI)
Power consumption	Power On	13W (Typ.)**
	Standby	≤0.5W
	Power off	≤0.3W
Input/output connector		D-Sub x1 HDMI x1 Earphone jack x1
Input video signal		D-Sub signal (D-Sub models only); HDMI signal (HDMI models only);
Speakers		NA
Audio effect		Audio output (only for audio output model)
Adapter		DC12V --- 2.0A
Environmental conditions		Operating temperature:0°C~40°C; Storage temperature:-20°C~60°C; Operating humidity:10~85%RH
Machine size(L x Wx H)		538.8X199.9X406.4mm(with arm/base) 538.8X39.3X318.7mm(without arm/base)
Box dimension(L x Wx H)		613X422X113mm
Weight (Net)		2.66 kg/Unit (with arm/base) 2.28 kg/Unit (without arm/base)
Machine specifications		Tilt: -5° to 20°

Compliance



The terms HDMI and HDMI High-Definition Multimedia Interface, and the HDMI Logo are trademarks or registered trademarks of HDMI Licensing Administrator, Inc. in the United States and other countries.

*Specifications are subject to change without notice.

**Measure a screen brightness of 200 nits without audio/USB/Card reader connection.

If you have any question regarding use of the monitor, please visit:

<https://www.coolermaster.com/warranty>

Supported Timing

PC Timing

Mode	Resolution	Horizontal Frequency (KHz)	Vertical Frequency (Hz)	Pixel Clock (MHz)	Port	
					HDMI IN	VGA IN
VGA	640x480@60Hz	31.469	59.940	25.175	o	o
	640x480@72Hz	37.861	72.809	31.500	o	o
	640x480@75Hz	37.500	75.000	31.500	o	o
MAC	640x480@66.66Hz	35.000	66.667	30.240	o	o
VESA	720x400@70Hz	31.469	70.087	28.322	o	o
SVGA	800x600@56Hz	35.156	56.250	36.000	o	o
	800x600@60Hz	37.879	60.317	40.000	o	o
	800x600@72Hz	48.077	72.188	50.000	o	o
	800x600@75Hz	46.875	75.000	49.500	o	o
MAC	832x624@74.55Hz	49.722	74.550	57.280	o	o
XGA	1024x768@60Hz	48.363	60.004	65.000	o	o
	1024x768@70Hz	56.476	70.069	75.000	o	o
	1024x768@75Hz	60.023	75.029	78.750	o	o
MAC	1152x870@75Hz	68.681	75.062	100.000	o	o
VESA	1152x864@75Hz	67.500	75.000	108.000	o	o
	1280x960@60Hz	60.000	60.000	108.000	o	o
SXGA	1280x1024@60Hz	63.981	60.020	108.000	o	o
	1280x1024@75Hz	79.976	75.025	135.000	o	o
VESA	1280x720@60Hz	45.000	60.000	74.250	o	o
WXGA	1280x800@60Hz	49.702	59.810	83.500	o	o
WXGA+	1440x900@60Hz	55.935	59.887	106.500	o	o
WSXGA+	1680x1050@60Hz	65.290	59.954	146.250	o	o
UXGA	1920x1080@60Hz	67.500	60.000	148.500	o	o
	1920x1080@75Hz	83.894	74.973	174.500	o	o
	1920x1080@100Hz	110.000	100.000	228.800	o	×

【Video Timing】

Video ID code	Formats	Aspect Ratio	Field Rate	Horizontal	Vertical (Hz)	Pixel Clock	H-Total	V-Total
1	640x480p	4:3	59.94	31.469	59.94	25.175	800	525
			60	31.500	60.00	25.200	800	525
3	720x480p	16:9	59.94	31.469	59.94	27.000	858	525
			60	31.500	60.00	27.027	858	525
4	1280x720p	16:9	59.94	44.955	59.94	74.176	1650	750
			60	45.000	60.00	74.250	1650	750
16	1920x1080p	16:9	59.94	67.433	59.94	148.352	2200	1125
			60	67.500	60.00	148.500	2200	1125
18	720x576p	16:9	50	31.250	50.00	27.000	864	625
19	1280x720p	16:9	50	37.500	50.00	74.250	1980	750
31	1920x1080p	16:9	50	56.250	50.00	148.500	2640	1125

Product Outline Dimensions

