

1. Disassembly Procedures

S1 Turn off power

S2 To remove the stand:

Place U3423WE monitor on U3417W curve sponge jig

Press and hold the stand release button

Lift the stand up and away from the monitor

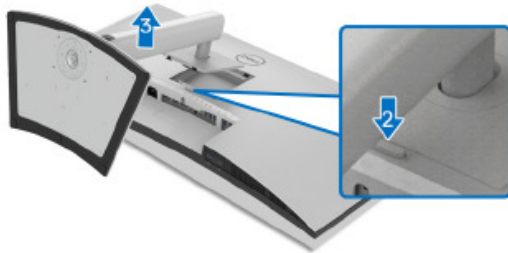

S3 Unlock 4 screws on Rear Cover



(Screw Torque:8-10Kgf)

S4 Use hands or Bar Scraper to disassemble Rear Cover from Middle Frame

Notice the disassembly order:
Left Side=>Top Side =>Right Side
=>Bottom Side



S5 Pull out “CTRL BD FFC” from I/F BD to take off Rear Cover



S6 Tear off a tape from Rear Cover

Tear off “CTRL FFC” from Rear Cover

Unlock 3 screws to disassemble “CTRL BD” from Rear Cover

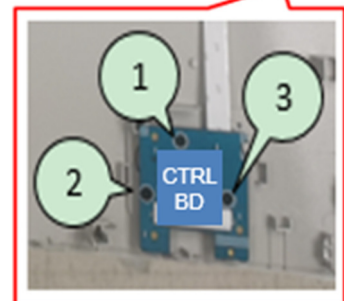
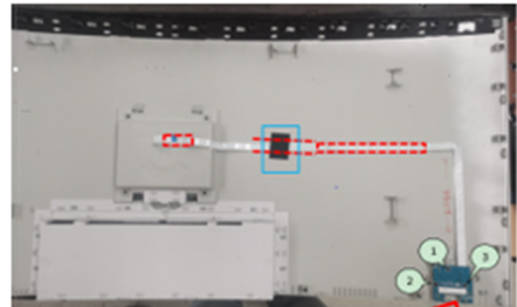

(Screw Torque: 2.0+0.5 Kgf)

- S7** Tear off a rubber from CTRL BD



- S8** Unplug "Backlight Wire" from LED Driver BD (See pink mark)

Unplug "Speaker Wire" from I/F BD (See blue mark)

Tear off 5 tapes from "Speaker Wire" and Panel (See red Mark)

Unlock 6 screws to disassemble Speaker from Middle Frame (See yellow mark)

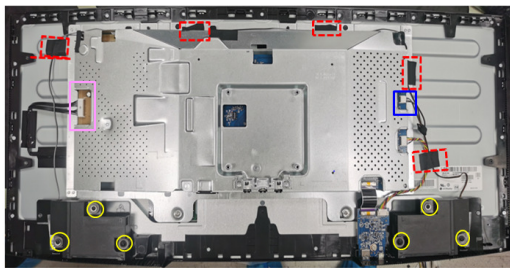

(Screw Torque: 5~6 Kgf)

- S9** Tear off an acetate tape from "USB BD Wire" and Panel

Unplug "USB BD FFC" and "USB BD Wire" from I/F BD

Unlock 1 screw to disassemble USB BD from Middle Frame



(Screw Torque: 4.5±0.5 Kgf)

- S10** Unplug "USB BD FFC" and "USB BD Wire" from USB BD

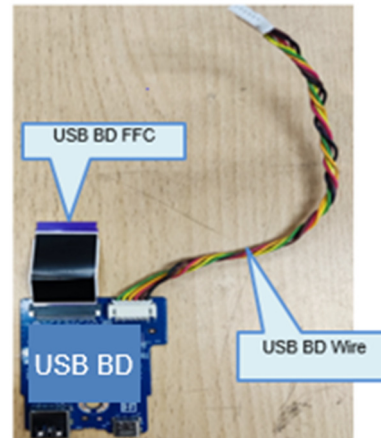

- S11** Disassemble a gasket from Panel

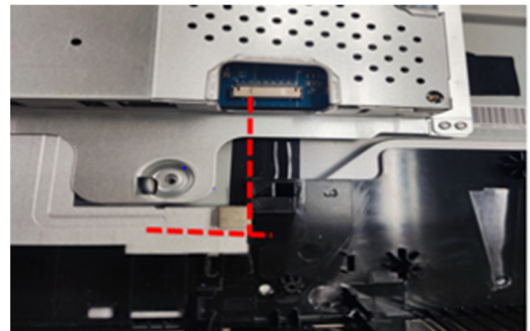

- S12** Unlock 4 screws to disassemble Main SHD from Panel

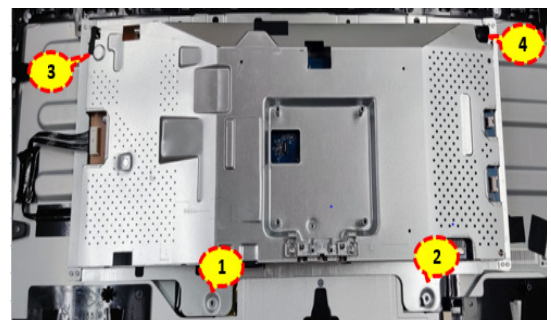

(Screw Torque: 4.5-5.5 Kgf)

- S13** Tear off an acetate tape from “FFC EDP” and panel

Tear off a yellow tape from “FFC EDP” connector

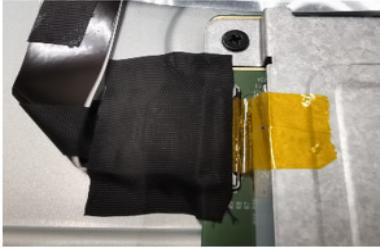

- S14** Unplug “FFC EDP” from panel

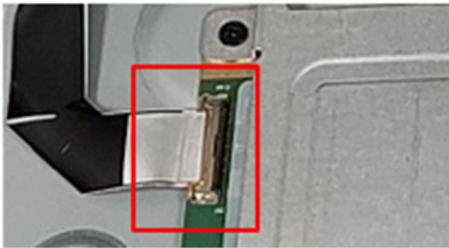

- S15** Take off Main SHD from Panel

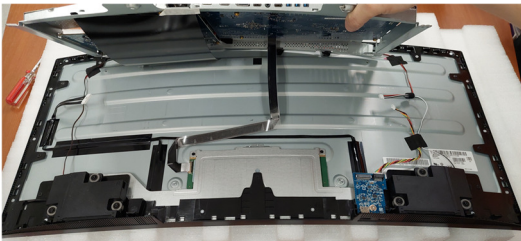

- S16** Unlock 19 screws to disassemble Middle Frame from Panel



(Screw Torque: 3.5-4.0 Kgf)

- S17** Disassemble 6 pieces of “BOSS PANEL” from panel



- S18** Disassemble Mylar from Main SHD

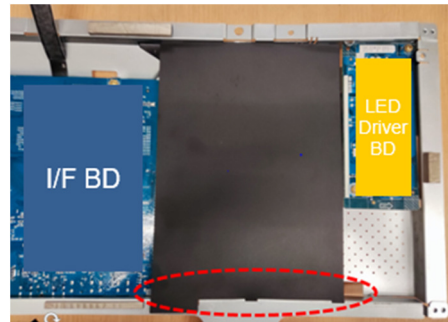

- S19** Unlock 10 PCBA screws to disassemble “I/F BD”, “SPS BD” and “LED Driver BD” from Main SHD

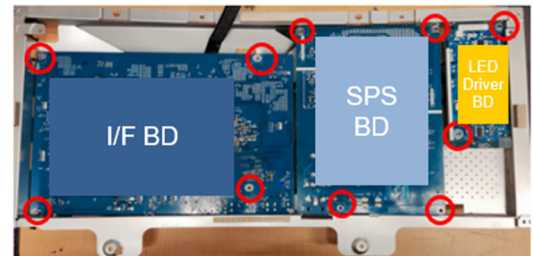

(Screw Torque: 8.5±1 Kgf)

- S20** Unplug wires from I/F BD, SPS BD and LED Driver BD

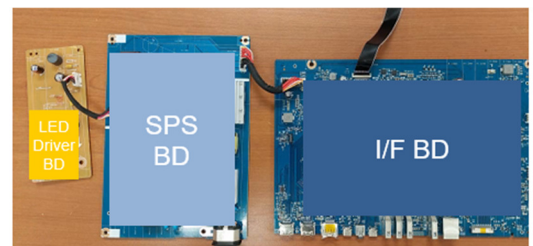

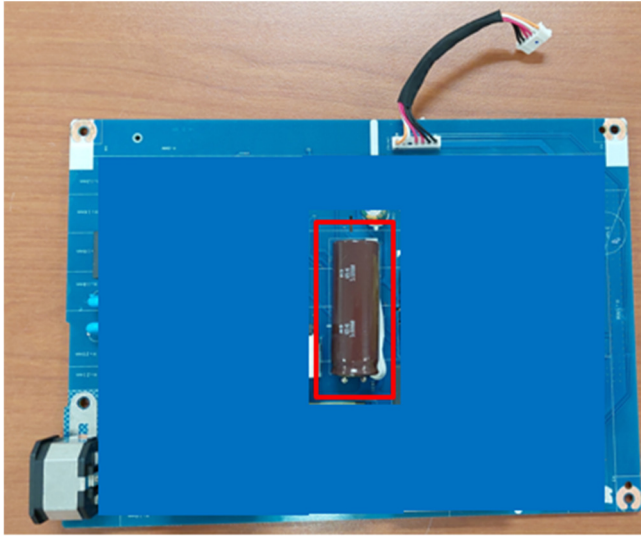
S21 Remove electrolyte capacitors (red mark) from printed circuit boards

S21-1 Cut the glue between bulk cap. and PCB with a knife

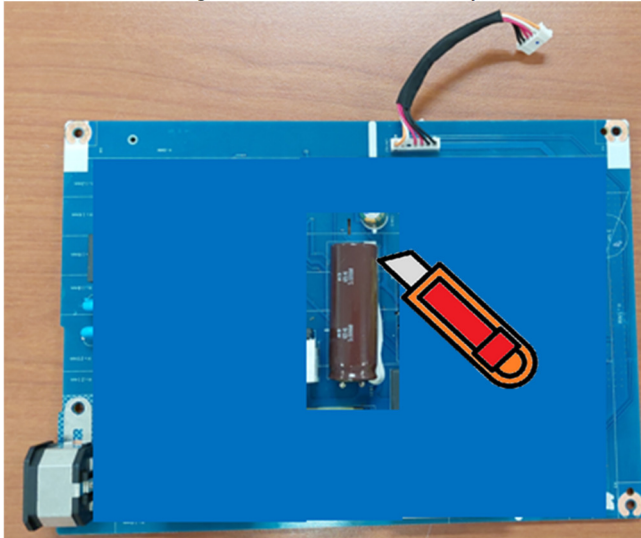

S21-2 Ensure cutting path within the glue, don't touch bulk cap. or PCB

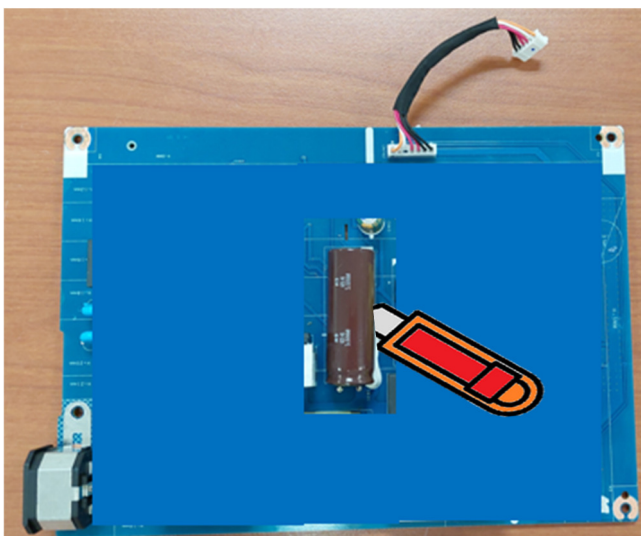

S21-3 Take out bulk cap. pin solder with soldering iron and absorber

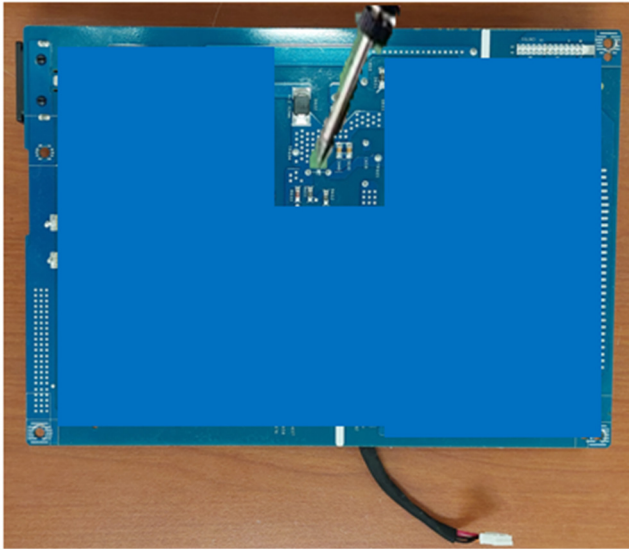

S21-4 Lift the bulk cap. up and away from the PCB

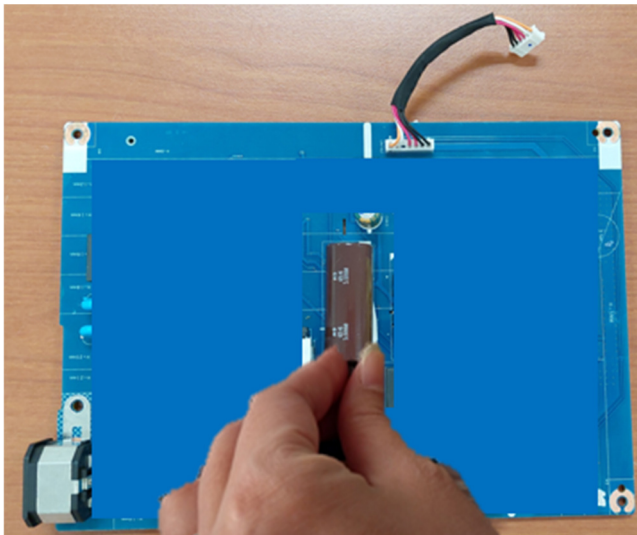

2. Product material information

The following substances, preparations, or components should be disposed of or recovered separately from other WEEE in compliance with Article 4 of EU Council Directive 75/442/EEC.

Capacitors / condensers (containing PCB/PCT)	No used
Mercury containing components	No used
Batteries	No used
Printed circuit boards (with a surface greater than 10 square cm)	Product has printed circuit boards (with a surface greater than 10 square cm)
Component contain toner, ink and liquids	No used
Plastic containing BFR	No used
Component and waste contain asbestos	No used
CRT	No used
Component contain CFC, HCFC, HFC and HC	No used
Gas discharge lamps	No used
LCD display > 100 cm ²	Product has an LCD greater than 100 cm ²
External electric cable	Product has external cables
Component contain refractory ceramic fibers	No used
Component contain radio-active substances	No used
Electrolyte capacitors (height > 25mm, diameter > 25mm)	Product has electrolyte capacitors (height >25mm, diameter > 25mm)

3. Tools Required

List the type and size of the tools that would typically can be used to disassemble the product to a point where components and materials requiring selective treatment can be removed.

Tool Description:

- Philips-head Screwdriver
- Penknife
- Bar scraper
- U3417W Curve Sponge Jig