

# TM-P80II Auto Cutter Model

## Technical Reference Guide

---

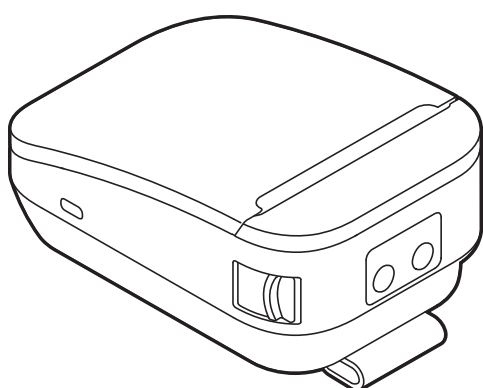

### Product Overview

Describes features of the product.

### Setup

Describes setup and installation of the product and peripherals.

### Handling

Describes how to handle the product.

### Advanced Usage

Describes advanced usage methods for the product.

### Application Development Information

Describes how to control the printer and necessary information when you develop applications.

### Appendix

Describes general specifications and character code tables.

## Cautions

- No part of this document may be reproduced, stored in a retrieval system, or transmitted in any form or by any means, electronic, mechanical, photocopying, recording, or otherwise, without the prior written permission of Seiko Epson Corporation.
- The contents of this document are subject to change without notice. Please contact us for the latest information.
- While every precaution has been taken in the preparation of this document, Seiko Epson Corporation assumes no responsibility for errors or omissions.
- Neither is any liability assumed for damages resulting from the use of the information contained herein.
- Neither Seiko Epson Corporation nor its affiliates shall be liable to the purchaser of this product or third parties for damages, losses, costs, or expenses incurred by the purchaser or third parties as a result of: accident, misuse, or abuse of this product or unauthorized modifications, repairs, or alterations to this product, or (excluding the U.S.) failure to strictly comply with Seiko Epson Corporation's operating and maintenance instructions.
- Seiko Epson Corporation shall not be liable against any damages or problems arising from the use of any options or any consumable products other than those designated as Original Epson Products or Epson Approved Products by Seiko Epson Corporation.

## Trademarks

EPSON is a registered trademark of Seiko Epson Corporation.

Exceed Your Vision and ESC/POS are registered trademarks or trademarks of Seiko Epson Corporation.

Microsoft and Windows are registered trademarks of Microsoft Corporation in the United States and/or other countries.

Wi-Fi<sup>®</sup>, WPA<sup>™</sup>, WPA2<sup>™</sup>, and WPA3<sup>™</sup> are either registered trademarks or trademarks of Wi-Fi Alliance<sup>®</sup>.

The Bluetooth<sup>®</sup> word mark and logos are registered trademarks owned by Bluetooth SIG, Inc. and any use of such marks by Seiko Epson Corporation is under license.

IOS is a trademark or registered trademark of Cisco in the U.S. and other countries and is used under license.

Apple, Apple TV, Apple Watch, iPad, iPad Air, iPad Pro, iPhone, and Lightning are trademarks of Apple Inc., registered in the U.S. and other countries. tvOS is a trademark of Apple Inc.

Android<sup>™</sup> is a trademark of Google LLC.

Google Play and the Google Play logo are trademarks of Google LLC.

QR Code is a registered trademark of DENSO WAVE INCORPORATED in Japan and other countries.

All other trademarks are the property of their respective owners and used for identification purpose only.

## ESC/POS<sup>®</sup> Command System



Epson ESC/POS is a proprietary POS printer command system that includes patented or patent-pending commands. ESC/POS is compatible with most Epson POS printers and displays.

ESC/POS is designed to reduce the processing load on the host computer in POS environments. It comprises a set of highly functional and efficient commands and also offers the flexibility to easily make future upgrades.

# For Safety

## Key to Symbols

The symbols in this manual are identified by their level of importance, as defined below. Read the following carefully before handling the product.

 <b>DANGER</b>	You must follow warnings carefully to avoid serious injury or death.
 <b>WARNING</b>	You must follow warnings carefully to avoid serious bodily injury.
 <b>CAUTION</b>	Provides information that must be observed to prevent damage to the equipment or loss of data. <ul style="list-style-type: none"><li>• Possibility of sustaining physical injuries.</li><li>• Possibility of causing physical damage.</li><li>• Possibility of causing information loss.</li></ul>
<b>CAUTION</b>	Provides information that must be observed to avoid damage to your equipment or a malfunction.
<b>NOTE</b>	Provides important information and useful tips.

## Cautions on Handling the Printer



### DANGER

Do not use, charge, leave, or store the product at temperatures in excess of 60°C (140°F). Doing so may cause the product to leak, generate heat or smoke, rupture, or burst into flame.



### WARNING

- ❑ Immediately remove the batteries from the printer or disconnect cables when a fault or other problem occurs, and contact qualified service personnel. Continued use may lead to fire or electric shock.
  - If the product emits smoke, a strange odor, or unusual noise.
  - If water or other liquid spills into the product.
  - If the product is too hot to touch or the case is deformed.
  
- ❑ Note the following points to avoid accidents such as fire, electric shock, or burn.
  - Do not use this product where flammable fumes from gasoline, benzene, thinner, or other flammable liquids may be in the air.
  - Do not use aerosol sprayers containing flammable gas inside or around the product.
  - Do not cover the product with cloth, or place the product in locations subject to high levels of humidity or dust.
  - Do not allow foreign objects or flammable objects to fall into the equipment.
  - Do not touch the inside of the product except where mentioned in the manual.
  - Be sure to use the specified batteries.
  - Use a power supply that complies with the USB standard.
  - Do not connect cables in ways other than those mentioned in the manual.
  - Never disassemble or modify the product.
  - In airplanes, follow the instructions from the airline. Turn off wireless devices during takeoff and landing according to the in-flight announcement.
  - Do not use the product near medical equipment or in medical institutions. Radio waves may affect artificial cardiac pacemakers or other medical electrical equipment.
  - Do not use the product near automatic control equipment such as automatic doors and fire alarms. Doing so may cause malfunction due to radio waves, resulting in an accident.



### CAUTION

- ❑ Note the following points to avoid injury or malfunction.
  - Do not place heavy objects on top of the product. Never stand or lean on the product.
  - Do not press your hands or fingers against the cutter when removing printed paper or loading/replacing roll paper.
  - Never attempt to repair the product yourself.
  
- ❑ To ensure safety, remove the batteries from the printer before leaving it unused for an extended period.

## Battery Safety Precautions



### DANGER

- ❑ **Risk of fire and burns.** Do not expose the battery to fire or heat it. This may cause fire, explosion, leakage, overheating or damage.
- ❑ Do not use or charge this product in high temperature places (60°C {140°F} or higher). Furthermore, do not leave or store this product in places that are 60°C {140°F} or higher. Doing so could lead to heat, smoke, ruptures, fire, or leaks.
- ❑ Do not directly solder the battery, and do not disassemble or modify it. This may cause fire, explosion, leakage, overheating or damage.
- ❑ Do not connect the terminals together. This may cause fire, explosion, leakage, overheating or damage.



- Do not connect the battery directly to a power outlet or the cigarette lighter of an automobile. This may cause fire, explosion, leakage, overheating or damage.
- If you cannot insert the battery smoothly, do not force it. This may cause fire, explosion, leakage, overheating or damage.
- If any liquid from the battery gets into your eyes, promptly wash it out with clean water for more than 10 minutes and consult your doctor at once. If you do not, the liquid may cause loss of eyesight.
- Do not crush.** Do not crush the battery or puncture it with a pointed object such as a nail. These may cause fire, explosion, leakage, overheating or damage due to internal short-circuit and heat generation of the battery.
- Unplug the charger if charging is still incomplete after the specified time it should take. Continuing to charge the battery may cause fire, explosion, leakage, overheating or damage.
- Do not expose the battery to water. Do not allow water to contact the terminals. This may cause fire, explosion, leakage, overheating or damage.
- Do not hit or throw the battery. This may cause fire, explosion, leakage, overheating or damage.
- Keep the battery away from fire or flame especially when it produces a strange odor or leakage. Otherwise fire, explosion, leakage, overheating or damage may occur.
- Should any battery liquid get on skin or clothing, promptly wash it off with clean water. If you do not, the liquid may damage your skin or clothing.
- Do not short the terminals with any metal objects such as a necklace. This may cause fire, explosion, leakage, overheating or damage, which lead to burn or injury.
- Do not put the battery in a microwave oven or high-pressure container. Doing so may result in electric shock or fire.



- Keep the battery out of the reach of children to avoid harm to the children.
- Do not use or charge this battery with any device other than the specified one. Doing so may cause fire, explosion, leakage, overheating or other damage.
- Do not use the battery if you find something wrong with it such as leakage, color change or deformity. Using the charger may cause fire, explosion, leakage, overheating or damage.



- Before using the battery, make sure that its terminals are clean without any foreign substance on them. Dirt and foreign substance on the terminals may cause fire, explosion, leakage, overheating or damage.
- Do not touch the battery right after using it for a long time. It will be hot and may burn you.
- If the battery is used improperly, it may explode.
- Dispose of used batteries according to the instructions.
- Do not place the battery in a humid or dusty place. Doing so may result in malfunction or fire.

## Cautions for Use and Storage of the Battery



- ❑ Charge the battery before using it. Immediately after purchase, the battery is not fully charged.
- ❑ Do not pull or push the battery hook forcefully.
- ❑ Keep the battery terminals clean, so that no dirt or foreign material becomes attached.
- ❑ When cleaning the battery, do not use any solvents, such as alcohol, benzine, or thinner. Doing so may deform or damage the plastic sections.
- ❑ Wipe off any dirt using a dry cloth.
- ❑ The battery slowly loses power while it is not being used.
- ❑ When charging the battery, charge it in an environment that is between 10°C and 30°C. To prevent deterioration in the battery performance, avoid direct sunlight, high temperatures, and high humidity, and store it in a cool location (around 20°C).
- ❑ If storing it for a long period of time, remove it from the printer or battery charger. Also, to prevent deterioration in its performance, we recommend that you charge it approximately once per year.  
Guide for charging: Battery charge status Level L. For details about the charge level, refer to the printer's User's Manual.
- ❑ If the battery life is remarkably short, the battery may have expired. Replace it with a new battery.

## Transportation of the Battery

In transportation of the battery, make sure to follow the latest UN recommendations.

## Recycling the Batteries

This battery is a lithium-ion battery. Must be recycled or disposed of properly.

---

## ***Restriction of Use***

When this product is used for applications requiring high reliability/safety, such as transportation devices related to aviation, rail, marine, automotive, etc.; disaster prevention devices; various safety devices, etc.; or functional/precision devices, etc., you should use this product only after giving consideration to including fail-safes and redundancies into your design to maintain safety and total system reliability. Because this product was not intended for use in applications requiring extremely high reliability/safety, such as aerospace equipment, main communication equipment, nuclear power control equipment, or medical equipment related to direct medical care, etc., please make your own judgment on this product's suitability after a full evaluation.

## ***Open Source Software License (Wi-Fi model)***

This product uses open source software in addition to Epson proprietary software.

For information of the open source software used in this product, see the following URL.

<http://xxx.xxx.xxx.xxx/PRESENTATION/ADVANCED/LICENSE/TOP>

For “xxx.xxx.xxx.xxx” in the above URL, input your printer’s IP address.

# Notes on Wi-Fi/Bluetooth® Interfaces

## Effects of Radio Wave Radiation on the Environment

This product is equipped with a radio module that has been certified as a radio facility for low-power data communication systems based on the Radio Law. The electromagnetic energy emitted by the radio module in this product is much lower than that emitted by other wireless devices (such as cell phones).

However, in certain environments where there is a risk of interference to other devices or services, the use of this product may be restricted by the owner of the building or person in charge of the organization. In a particular environment, such as in an airport, if you are not sure whether the use of your wireless device will be restricted, inquire about permission to use this product before turning it on.

## Notes on Interference

- When setting up or using this product, be sure to follow the instructions in this manual. Setting up or using this product without following this manual may cause harmful interference to other wireless communications.
- If this product causes harmful interference to radio or television reception, the user is encouraged to try to correct the interference by one or more of the following measures.
  - Change the direction and location of the TV/radio receiving antenna
  - Install the product away from the TV/radio
  - Connect this product to an outlet other than the one to which the TV/radio is connected
  - Talk to an experienced radio/TV technician
- Please take the following points into consideration when using the product in an environment where there are devices that generate radio interference, such as microwave ovens.
  - Install the product as far away as possible from devices that may cause radio interference.
  - Use channels that are away from frequency bands that cause radio interference.
  - Install a shielding board between this product and devices that generate radio wave interference.
  - Use a frequency band that will not cause interference, either 2.4 GHz or 5 GHz.
  - When setting the auto channel of the access point, make sure that this product is not set to a channel that causes radio interference.
- Do not attempt to disassemble or modify this product.  
We assume no responsibility whatsoever for any harmful interference to other wireless communications caused by unauthorized modification.



# Notes on Wireless LAN Connection

This product has not been confirmed to work with all wireless LAN devices, and operation with all wireless LAN devices is not guaranteed.

## Notes on Wireless LAN Security

The following are important matters concerning your rights (privacy protection).

Instead of using LAN cables, wireless LANs use radio waves to exchange information, which has the advantage of allowing free LAN connections within the range of the radio waves. On the other hand, radio waves can reach anywhere within a certain range, even over obstacles (walls, etc.), so if no security settings are made, the following problems may occur.

---

### Having your information stolen

There is a possibility that a malicious third party may intentionally intercept radio waves and steal personal information such as IDs, passwords or credit card numbers, as well as communication contents such as the contents of emails.

---

### Access from unauthorized users

A malicious third party may gain unauthorized access to your personal or company network to do the following.

- Taking out personal or confidential information (information leakage)
- Communicating by impersonating a specific person and distributing fraudulent information (spoofing)
- Rewriting and sending intercepted communications (tampering)
- Destroy data and systems by spreading computer viruses, etc. (Destruction)

Essentially, wireless LAN cards and wireless access points have a security mechanism to deal with these problems, so by using the product with the settings related to the security of the wireless LAN product, the possibility of such problems occurring will be reduced. It is recommended that you fully understand the problems that may occur if you do not configure the security settings, and use the product after configuring the security settings at your own discretion and responsibility.

## Notes on SSID (Service Set Identifier) Settings

For security reasons, please observe the following precautions regarding SSID settings.

- Make sure to change the SSID from the default setting.
- Do not set the SSID to a string that can identify the owner.





## Notes on Setting the Encryption Key

For security reasons, please observe the following precautions when setting the encryption key.

- Avoid using words from the dictionary as much as possible.
- Combine meaningless alphanumeric characters and symbols.
- Use a string of at least 13 characters, preferably 20 characters or more.

# Manuals for This Product

The following manuals are available for this product.

<p>Paper manual</p> 	<p>Manuals, such as Setup Guide, included in the product package</p> <p>Explains how to install and set up this product, from checking the bundled items. Precautions for handling this product are also provided. To ensure safe and correct use and to prevent harm to you or others, or damage to property, please read the paper manuals before using the product.</p>
<p>Manuals viewed on computers and smart devices</p> 	<p>User's Manual</p> <p>Describes the functions of this product, how to operate it, information on maintenance, and how to solve various problems. In addition to the URL below, you can also access it from the QR code attached to the product itself.</p> <p>&lt;<a href="https://www.epson-biz.com/?prd=tm-p802ac&amp;inf=manual-ww">https://www.epson-biz.com/?prd=tm-p802ac&amp;inf=manual-ww</a>&gt;</p>
<p>Manuals viewed on computers</p> 	<p>TM-P80II Auto Cutter Model Technical Reference Guide (this manual)</p> <p>Describes information necessary to set up this product, perform daily tasks, and develop your own system.</p>
<p>Manuals viewed on computers and smart devices</p> 	<p>Web video manual</p> <p>Explains in an easy-to-understand manner how to set up this product and how to connect this product via Wi-Fi or Bluetooth. You can access the manual from the URL below.</p> <p>&lt;<a href="https://www.epson-biz.com/?prd=tm-p802ac&amp;inf=video">https://www.epson-biz.com/?prd=tm-p802ac&amp;inf=video</a>&gt;</p> <p>The contents of the videos are subject to change without notice.</p>

# About this Manual

## Aim of the Manual

This manual was created to provide information on development, design, and installation of POS systems and development and design of printer applications for developers.

## Manual Content

The manual is made up of the following sections:

Chapter 1	<a href="#">Product Overview</a>
Chapter 2	<a href="#">Setup</a>
Chapter 3	<a href="#">Handling</a>
Chapter 4	<a href="#">Advanced Usage</a>
Chapter 5	<a href="#">Application Development Information</a>
Appendix	<a href="#">Product Specifications</a> <a href="#">Specifications of Interface</a> <a href="#">Character Code Tables</a>

# Contents

■ For Safety .....	3
Key to Symbols.....	3
Cautions on Handling the Printer .....	4
Battery Safety Precautions.....	4
Cautions for Use and Storage of the Battery.....	6
Transportation of the Battery .....	6
Recycling the Batteries.....	6
■ Restriction of Use .....	7
■ Open Source Software License (Wi-Fi model) .....	7
■ Notes on Wi-Fi/Bluetooth® Interfaces .....	8
Effects of Radio Wave Radiation on the Environment .....	8
Notes on Interference.....	8
■ Notes on Wireless LAN Connection .....	9
Notes on Wireless LAN Security .....	9
Notes on SSID (Service Set Identifier) Settings.....	9
Notes on Setting the Encryption Key.....	9
■ Manuals for This Product.....	10
■ About this Manual .....	11
Aim of the Manual .....	11
Manual Content.....	11
■ Contents.....	12

---

## ***Product Overview .....*** 16

■ Features .....	16
■ Product Configurations .....	18
Models.....	18
NFC Tag .....	18
Buzzer .....	18
Accessories .....	18
Consumables and Options .....	18
■ Part Names and Functions .....	19
Body.....	19
Operation Panel.....	20
Online and Offline.....	23
■ Power Supply Function .....	24
Auto Power-Off .....	24
Battery Charge Mode.....	24
Operation Mode When Battery is Low .....	25
Desktop Mode.....	26
■ Status and Errors .....	27

Status Display .....	27
Battery Charge Indication .....	28
Network Connection Status (Wi-Fi model) .....	28
Bluetooth Connection Status (Bluetooth model).....	29
Error Status .....	29
<b>■ NV Memory (Non-Volatile Memory) .....</b>	<b>31</b>
NV Graphics Memory .....	31
User NV memory .....	31
Memory Switches (customized values).....	31
Maintenance Counter .....	31
<b>■ Useful Functions for Smart Devices .....</b>	<b>32</b>
NFC Tag .....	32
QR Code .....	32
<b>■ Printing Using Multiple Interfaces .....</b>	<b>33</b>
<hr/>	
<b>Setup .....</b>	<b>34</b>
<b>■ Placing or Hanging the Printer .....</b>	<b>34</b>
Placing the Printer on a Flat Surface .....	34
Hanging the Printer from a Belt .....	35
<b>■ Installing the Battery .....</b>	<b>36</b>
How to Install the Battery .....	36
How to Remove the Battery .....	36
<b>■ Charging the Battery .....</b>	<b>37</b>
Charging the Battery using the Included USB Cable .....	37
Charging the Battery with the Optional Battery Charger.....	38
Wireless Charging .....	39
<b>■ Turning the Power On/Off .....</b>	<b>40</b>
Turning the Power On .....	40
Turning the Power Off .....	40
<b>■ Installing Roll Paper .....</b>	<b>41</b>
How to Open the Roll Paper Cover .....	41
How to Close the Roll Paper Cover .....	42
Installing or Replacing the Roll Paper.....	43
<b>■ Anti-Curl Function.....</b>	<b>44</b>
How to Disable the Anti-Curl Function .....	44
<b>■ Connecting the Printer to the Host Device .....</b>	<b>45</b>
USB Interface .....	45
Bluetooth Interfaces (Bluetooth model).....	45
Wi-Fi Interface (Wi-Fi model) .....	49

---

**Handling ..... 54****■ Cleaning ..... 54**

Cleaning the Printer Case .....54

Cleaning the Thermal Head.....55

Cleaning the Platen Roller and Paper Detector .....56

**■ Troubleshooting..... 57**

When the Roll Paper Jams.....57

When the Roll Paper Cover dose Not Open.....57

Printout is Faint .....58

Cannot Print .....58

---

**Advanced Usage ..... 59****■ Software Settings..... 59**

Overview of Each Function.....60

**■ Paper Layout Setting ..... 69****■ MAC Address Confirmation..... 70****■ Setting/Check Modes ..... 71**

Self-test Mode .....73

NV Graphics Information Print Mode.....74

Software Setting Mode .....75

Restore Default Values Mode.....77

Interface Setup Mode.....78

Radio field intensity check mode (Wi-Fi model) .....82

Hexadecimal Dumping Mode .....83

**■ Printing a Status Sheet..... 84****■ Web Config ..... 86**

How to Start Web Config.....86

What can be Configured in Web Config .....87

---

**Application Development Information..... 88****■ Controlling the Printer ..... 88**

ePOS-Print XML.....88

ESC/POS.....88

**■ Software..... 89**

Development Kit .....89

Drivers .....90

Utilities .....90

Others.....91

Download .....91

**■ Precautions when Developing Applications ..... 92**

Notes on Printing Barcodes and Two-Dimensional Symbols.....	92
Application Development and Distribution for iOS (Bluetooth model) .....	92

---

<b>Appendix.....</b>	<b>93</b>
■ <b>Product Specifications .....</b>	<b>93</b>
■ <b>Printing Specifications .....</b>	<b>94</b>
■ <b>Character Specifications.....</b>	<b>96</b>
■ <b>Paper Specifications .....</b>	<b>98</b>
■ <b>Printing Area .....</b>	<b>100</b>
80 mm width model.....	100
58 mm width model.....	101
■ <b>Print Position and Auto Cut Position .....</b>	<b>102</b>
■ <b>Electrical Characteristics.....</b>	<b>103</b>
■ <b>Reliability.....</b>	<b>104</b>
■ <b>Environmental Conditions .....</b>	<b>105</b>
■ <b>External Dimensions .....</b>	<b>107</b>
■ <b>Specifications of Interface.....</b>	<b>108</b>
USB Interface .....	108
Network Interface (Wi-Fi model) .....	109
Bluetooth Interface (Bluetooth model).....	112
NFC Tag .....	115
■ <b>Character Code Tables.....</b>	<b>116</b>

# Product Overview

This chapter describes the features and overview of the product.

## Features

TM-P80II Auto Cutter Model is a thermal mobile printer. The main features of this product are as follows.

---

### Printing

- Maximum printing speed is 65 mm/s (max. 100 mm/s when the anti-curl function is disabled).
- Supports a wide variety of languages (ANK (including Thai) / Japanese (JIS 1st, 2nd, 3rd, 4th levels) / Simplified Chinese / Traditional Chinese / Korean) controlled by UTF-8

---

### Printer handling

- Compact and lightweight  
(Wi-Fi model: 58 mm model weighs approx. 520 g {1.15 lb}, 80 mm model weighs approx. 511 g {1.13 lb})  
(Bluetooth model: 58 mm model weighs approx. 513 g {1.13 lb}, 80 mm model weighs approx. 504 g {1.11 lb})
- Can be used for a long time with a battery (approx. 24 hours for Wi-Fi model, approx. 34 hours for Bluetooth model)
- Wi-Fi models offer Wi-Fi (IEEE802.11a/b/g/n/ac) function as standard.
- Bluetooth models offer Bluetooth function as standard.  
Bluetooth 5.0 Dual mode: Outside Brazil /Bluetooth Dual mode: Brazil
- Wi-Fi or Bluetooth connection status can be easily checked by viewing respective LED lights.
- IP54 compliant water and dust resistance
- Equipped with a USB (Type-C) interface as standard.
- Withstands the impact of a fall from a height of 150 cm {59.06 in.} (Compliant with JIS C60068-2-31: 2013 (IEC 60068-2-31: 2008))
- Easy drop-in paper loading
- Equipped with an anti-curl function that reduces curling of roll paper.
- Equipped with an auto cutter.
- Belt clip for improved portability in a mobile environment
- A utility for iOS/Android™ (Epson TM Utility) for making printer settings is provided.

---

### Functions

- Offers network connection check function. (Wi-Fi model)
- Information necessary for connecting to the printer can be obtained using the NFC tag built in the printer or a QR code printed on a status sheet.
- It is possible to perform printing operations by scanning a barcode with a smart device's camera.



- Printing is possible through multiple built-in interfaces. See "[Printing Using Multiple Interfaces](#)" on page 33 for more details.
- Printing of various types of bar codes, GS1-DataBar, and two-dimensional symbols (PDF417, QR code, MaxiCode, Composite Symbology, Aztec Code, DataMatrix) is supported.
- A maintenance counter function is supported.

---

## Environment

- Offers a paper-saving function.

# Product Configurations

## Models

- Wi-Fi model (Wi-Fi + USB)
- Bluetooth model (Bluetooth + USB)

## NFC Tag

By bringing an NFC-compatible device close to the NFC tag  on the printer, you can use the function to select the printer to print from. There is a limit to the distance over which communication is possible. See ["NFC Tag" on page 115](#).

### NOTE

- Data in the NFC tag cannot be rewritten.
- Use Epson ePOS SDK to build this function into your application.

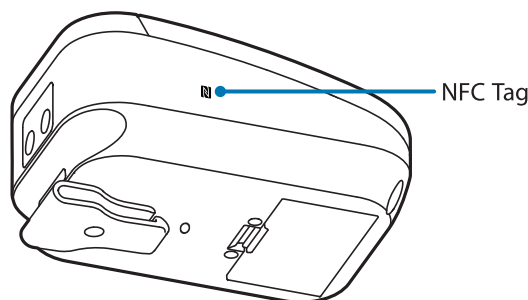

## Buzzer

The printer has built-in buzzer function.

## Accessories

- Roll paper for operation check
- Battery (OT-BY80II)
- Belt clip (already attached to printer)
- USB-C cable (Type-C to Type-C, approx. 1.0 m long)
- Manuals

## Consumables and Options

- Battery (Model number: OT-BY80II)
- Single battery charger (Model number: OT-SB80II)
- Quadruplet battery charger (Model number: OT-CH80II)
- Soft case (Model number: OT-PC80IIAC)
- Belt strap (Model number: OT-BE01)
- Shoulder strap (Model number: OT-SH01)

## Part Names and Functions

### Body

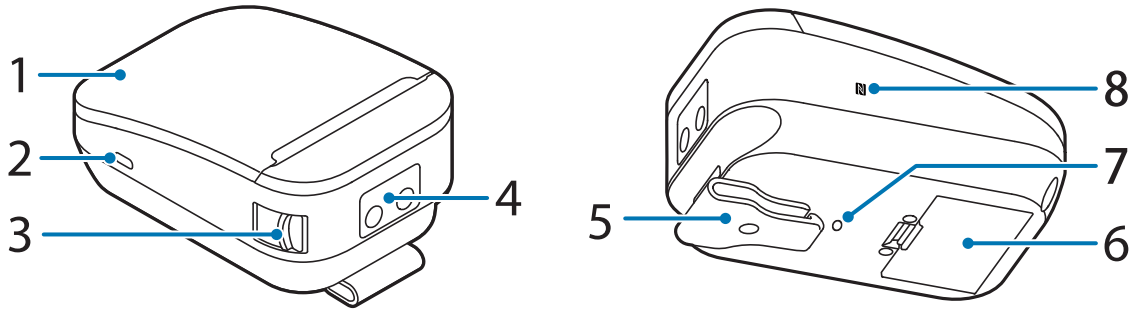

1	Roll paper cover	Open this cover when installing or replacing the roll paper.
2	USB-C connector	Connects a USB-C cable.
3	Cover open lever	Operate this lever to open the roll paper cover.
4	Operation panel	There are buttons to operate the printer and LEDs to display the printer status.
5	Belt clip	A clip for hanging the printer from a waist belt.
6	Battery	Provides electricity to the printer. The printer does not work without the battery installed.
7	Wireless charging position	You can charge the printer by placing the printer on a commercially available wireless charger with the  symbol on the printer aligned with the designated position on the charger.
8	NFC Tag	A mark is printed here to indicate the position of the NFC tag. Bring an NFC-compatible device close to the mark to obtain information about the printer. For the functions using the NFC tag, refer to <a href="#">"Useful Functions for Smart Devices"</a> on page 32.





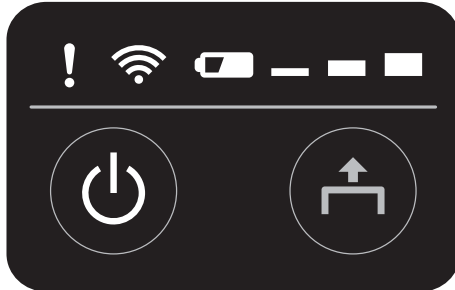

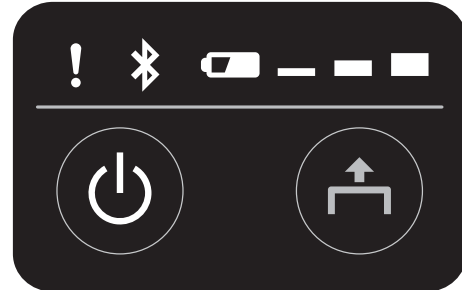

## Operation Panel

Wi-Fi model



Bluetooth® model



	Power button	This button turns the printer on or off.
	Feed button	Press this button once to feed the roll paper for one line. Hold down this button to continue feeding the roll paper.
	Power LED	This turns on when the printer is on.
	Error LED	Turns on when the printer is temporarily unable to print, such as when no roll paper is loaded or the roll paper cover is open. Flashes when an error occurs.
	Charge LED	Indicates whether the battery is charging or not.
	Battery LED	Indicates remaining battery charge.
	Wi-Fi LED	Turns on when the printer is connected to Wi-Fi.
	Bluetooth LED	Turns on when the printer is connected via Bluetooth.

## Buttons

### (Power) button

This button turns the printer on or off.

- To turn on the printer, press the power button for about one second and release it when the power LED lights up.
- To turn off the printer, press the power button for about two seconds and release it when the power LED goes off or starts flashing.

#### NOTE

- After pressing the power button, it takes approximately the following time for the printer to initialize. This does not include the time it takes for communication to be established.
  - \* Wi-Fi model: Approx. 5 seconds after the power LED lights up
  - \* Bluetooth model: Approx. 5 seconds after the power LED lights up
- When turning on the power again immediately after turning off the power, make sure that all LEDs are off before turning on the power again.
- Always use the power button when turning off the power. If the battery is removed while the power is on, the maintenance counter value will not be updated correctly.
- If you want to turn off the printer without using the power button, it is recommended that you send the command to execute the power-off process to the printer before turning it off. This will save the latest maintenance counter values. The maintenance counter values are usually saved every two minutes. For more information about the command, see the ESC/POS Command Reference.

## Feed Button

- Press this button once to feed the roll paper for one line. Hold down this button to continue feeding the roll paper.
- When the Paper Layout Setting is Receipt paper (with black mark), the paper is fed to the print start position.

### NOTE

The function of the paper feed button can be disabled (inoperative). Refer to the ESC/POS Command Reference for more details.

## LED

### NOTE

If a charged battery is not installed in the printer, the printer will not operate and the LED will not light.

## Power LED (Blue)

- Stays on while the printer is on.
- Stays off while the printer is off.
- Flashes when the printer is in the following conditions.
  - Power-off standby process is in progress or power-off process is in progress
  - Updating the firmware
  - Starting up the network, or link-down
  - Resetting the printer or the communication settings is in progress
  - Network warning error

## Error LED (Orange)



- Lights or flashes when an error occurs. For information about the flashing patterns, see "[Status and Errors](#)" on page 27.
- Lights after the power is turned on or after a reset (offline). Automatically goes out after a while to indicate that the printer is ready.
- Off when the printer is in standard mode (online).
- Lights up when the battery level is at the E level or when there is no battery remaining. See "[Operation Mode When Battery is Low](#)" on page 25 for information about the battery level.

## — — ■ Battery LED

Three LEDs indicate the battery level. These LEDs will not light unless you turn on the printer.

See ["Operation Mode When Battery is Low" on page 25](#) for information about the battery level.

— : ON    ■ : Flashing    □ : OFF

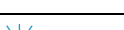
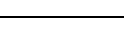
Battery LED	Battery Level	Description
	H level	You can continue to use the printer.
	M level	You can continue to use the printer.
	L level	You can continue to use the printer, but we recommend recharging the battery or replacing it with a charged battery.
	S level	Charge or replace the battery.
	E level	Charge or replace the battery.

### NOTE

- A buzzer can be activated when the battery level reaches the L or S level. The buzzer setting can be made using TM-P80II Utility or in the software setting mode. See ["Software Settings" on page 59](#) for more details.
- When the battery level reaches the E level, the error LED lights up.

## 🔌 Charge LED

Indicates whether the battery is charging or not.

- Stays on while the battery is charging.
- Flashes when there is an abnormality in battery charging.
- Turns off when the battery charge is complete and stays off while the battery is fully charged.

## 📶 Wi-Fi LED

- Lights when the printer is connected to Wi-Fi and ready for communication.
- Flashes when the printer is temporarily unable to communicate, such as when it is obtaining an IP address after being connected to Wi-Fi.
- Off while the printer is not connected to Wi-Fi.

## 📶 Bluetooth LED

- Lights while the printer is connected via Bluetooth.
- Flashes while the printer is waiting to be paired with another device.
- Off while the printer is not connected via Bluetooth.

## Online and Offline

### Online

The printer is online and ready for normal printing unless there is a reason to go offline.

### Offline

The printer automatically goes offline under the following conditions:

- While the printer power is turning on/off
- While roll paper is fed using the Feed button
- When the printer stops printing due to a paper end (when the paper out detector detected the paper out)
- During an operation standby state
- When an error has occurred (See "[Status and Errors](#)" on page 27)
- While the roll paper cover is open
- When the battery level is at the E level or when there is no battery remaining

**NOTE**

- The Error LED is lit while offline, but flashes when an error occurs.
- See "[Operation Mode When Battery is Low](#)" on page 25 for information about the battery level.
- A buzzer can be set to sound when the printer runs out of roll paper, an error occurs, or the battery power is low. The buzzer setting can be made using TM-P80II Utility or in the software setting mode. See "[Software Settings](#)" on page 59 for more details.

## Power Supply Function

The auto power-off function and battery charging mode can be used to reduce battery consumption or minimize battery degradation.

### NOTE

At low temperatures, battery performance is reduced. This is temporary and performance will be restored when the battery is returned to room temperature.

### Auto Power-Off

The auto power-off function automatically turns off the printer if all of the following conditions are met after a certain period of time.

- Printing is not in progress.
- Paper is not being fed.
- Cover open/close operation is not in progress.
- No button is being pressed.
- No command is being received (receive buffer is empty) \*Except for real-time commands.
- Bluetooth pairing is not in progress. (Bluetooth model)

The time for auto power-off can be set from 0 (disabled) to 60 minutes (in one-minute increments).

The default setting is "0" (disable).

### NOTE

- The auto power-off setting can be made using TM-P80II Utility or in the software setting mode. See "[Software Settings](#)" on page 59 for more details.
- This function does not work when the USB interface is connected (the printer does not automatically turn off).
- The time set is the time to start the power off process, not the time when the power is turned off.

### Battery Charge Mode

There are two battery charge modes for charging the battery: Mode 1 and Mode 2. The default setting is Mode 1.

### NOTE

The battery charge mode can be changed using TM-P80II Utility or in the software setting mode. See "[Software Settings](#)" on page 59 for more details.

#### Mode 1

Charging begins when the battery level drops to approximately 80%. Controls the battery level so that it is always fully charged.

#### Mode 2

Charging begins when the battery level drops to 67% and continues charging until it reaches 80%.

Mode 2 is recommended when the printer is constantly connected to a USB charging adapter or computer. The number of times the battery needs to be recharged is reduced and battery degradation is mitigated.



## Operation Mode When Battery is Low

There are two modes of operation when the battery is low: Mode 1 and Mode 2. The default setting is Mode 1.

### NOTE

- The operation mode when battery is low can be changed using TM-P80II Utility or in the software setting mode. See "Software Settings" on page 59 for more details.
- The battery level is detected before printing begins, and the displayed level is subsequently updated. The battery LED does not indicate real-time battery level.
- When the battery level reaches the "L" level, it is recommended to recharge the battery or replace it with a charged battery.
- When the battery level reaches the "S" or "E" level, recharge the battery or replace it with a charged battery.
- A buzzer can be activated when the battery level reaches the L or S level. The buzzer setting can be changed using TM-P80II Utility or in the software setting mode. See "Software Settings" on page 59 for more details.

## Mode 1

Allows you to print until the battery runs out.

■ : ON    ■■■ : Flashing    □ : OFF

Level	Battery LED	Error LED	Battery Level	Printing	Communication
H	■ ■ ■	! (Off)	Approx. 100 to 60%	Possible	Possible
M	■ ■ □	! (Off)	Approx. 60 to 20%	Possible	Possible
L	■ □ □	! (Off)	Approx. 20 to 10%	Possible	Possible
S	■■■ □ □	! (Off)	Less than approx. 10%	Possible*	Possible
E	□ □ □	! (On)	Approx. 0%	Not possible	Not possible

\* Printing is possible, but printing may stop halfway through. Print quality cannot be guaranteed.

## Mode 2

Printing stops when the remaining battery level falls below approximately 10%.

■ : ON    ■■■ : Flashing    □ : OFF

Level	Battery LED	Error LED	Battery Level	Printing	Communication
H	■ ■ ■	! (Off)	Approx. 100 to 60%	Possible	Possible
M	■ ■ □	! (Off)	Approx. 60 to 40%	Possible	Possible
L	■ □ □	! (Off)	Approx. 40 to 20%	Possible	Possible
S	■■■ □ □	! (Off)	Approx. 20 to 10%	Possible	Possible
E	□ □ □	! (On)	Less than approx. 10%	Not possible	Not possible

## Desktop Mode

Enabling the desktop mode may speed up the printing speed.

Disabling it will change the line feed speed according to the battery level. The default setting is "Disable".

Enabling the mode is recommended when the printer is constantly connected to USB charging adapter or computer.

**NOTE**

The desktop mode can be set using TM-P80II Utility or in the software setting mode. See "[Software Settings](#)" on page 59 for more details.

## Status and Errors

The status of the printer is indicated by lit and flashing LEDs.

### CAUTION







You cannot print when an error has occurred.

### NOTE

You cannot identify the error by the flashing patterns of the LEDs. Develop the application so that users can identify the error description and check the solutions.

## Status Display

●: ON ●: Flashing ○: OFF -: Ignore the LED light

Power LED 	Error LED 	Charge LED 	Battery LED 	Wi-Fi LED 	Bluetooth LED 	Printer status
●	○	-	-	-	-	Online (normal state)
●	●	-	●	-	○	While initializing after turning on the power
●	○	-	-	-	○	Self-testing in progress
● <sup>*1</sup>	○	-	-	-	○	Waiting for the self-test to continue
●	○	-	-	-	-	Paper is being fed with the paper feed button
● <sup>*1</sup>	○	-	-	-	-	Waiting for a Macro execution to run
●	●	-	-	-	-	Roll paper cover opened when not printing
●	●	-	-	-	-	No roll paper
●	●	-	-	-	-	Automatically recoverable error
●	●	-	-	-	-	Recoverable error
●	● <sup>*1</sup>	-	○	-	○	Unrecoverable error Turn off the power immediately.
● <sup>*1</sup>	○	-	○	-	○	Updating the firmware (Wi-Fi model)
●	● <sup>*2</sup>	-	○	-	○	Updating the firmware (Bluetooth model)
● <sup>*1</sup>	●	-	○	-	○	Power-off standby process is in progress or power-off process is in progress
●	○	-	-	● <sup>*1</sup>	-	Starting up the network + link-down display
● <sup>*1</sup>	○	-	-	-	-	Resetting the printer or the communication settings is in progress







\*1: The LED flashing pattern is: lighting for 320 ms followed by a pause for 320 ms.

\*2: The LED flashing pattern is: lighting for 320 ms followed by a pause for 320 ms. After repeating it twice, lights up for 640 ms and goes off.

## Battery Charge Indication

The status of the battery charge is indicated as follows.

●: ON   ●: Flashing   ○: OFF

When Printer is On			When Printer is Off			Battery status
Power LED 	Error LED 	Charge LED 	Power LED 	Error LED 	Charge LED 	
●	○	●	○	○	●	Charging (0-40°C)
●	○	○	○	○	○	The battery is fully charged or does not need to be charged
●	○	●	○	○	●	Outside the chargeable temperature range: -20 (not including -20) to less than 0°C, or 40 (not including 40) to less than 55°C
●	●	●				Battery high temperature error (55°C or higher) Battery low temperature error (-20°C or lower) Battery failure

- Battery charging should be performed under ambient temperatures within the guaranteed operating range of 0 to 40°C (32 to 104°F).
- Charging will stop if the ambient temperature is outside the chargeable temperature range (below 0°C or above 40°C).
- When charging in an environment of 35°C or higher, the charging time may be extended because the internal temperature rise is detected and charging is stopped and started repeatedly.
- If the battery is not fully charged after approximately 5 hours of charging, it is assumed that the battery is faulty and the Charge LED will flash. The battery cannot be used and should be replaced with another battery.

## Network Connection Status (Wi-Fi model)

●: ON   ●: Flashing   ○: OFF

Wi-Fi LED 	Printer status
●	The printer is connected to Wi-Fi and ready for communication.
●	The printer is temporarily unable to communicate, such as when it is obtaining an IP address after being connected to Wi-Fi.
○	Not connected to a network

The LED flashing pattern is: lighting for 320 ms followed by a pause for 320 ms.

## Bluetooth Connection Status (Bluetooth model)

●: ON ●: Flashing ○: OFF

Bluetooth LED 	Printer status
●	Connecting via Bluetooth
●	Waiting to be paired with a device
○	Not connected via Bluetooth

The LED flashing pattern is: lighting for 320 ms followed by a pause for 320 ms.

## Error Status

When an error occurs, the printer goes offline and the error LED flashes.

There are three types of errors depending on the recovery method: automatically recoverable errors, recoverable errors, and unrecoverable errors.

### Automatically Recoverable Errors

If an automatically recoverable error occurs, printing is not possible. The printer can recover from the errors as described below.

Error	Description	Recovery
Print head high temperature error	Head temperature exceeded the proper range (high temperature).	The printer recovers from the error when the head temperature drops.
Cover open error in the middle of printing	The roll paper cover was opened during printing.	The printer recovers from the error when the roll paper cover is closed.
Motor driver IC high temperature error	Motor driver IC temperature exceeded the proper range (high temperature).	The printer recovers from the error when the motor driver IC temperature drops.
Battery high temperature error	Battery temperature exceeded the proper range (high temperature).	The printer recovers from the error when the battery temperature drops.
Battery low temperature error	Battery temperature is below the proper range (low temperature).	The printer recovers from the error when the battery temperature rises.
Paper error	Black marks cannot be detected.	The printer recovers from the error when the paper is changed to paper with black marks.

## Recoverable Errors

If a recoverable error occurs, printing is not possible. To restore the printer to its normal state, remove the cause of the error and then send an error recovery command.

**NOTE**

The error recovery command is valid only when a recoverable error (excluding automatic recovery errors) occurs.

Error	Description	Recovery
Auto cutter error	The cutter blade is locked due to a foreign object fell inside the printer or other reason.	Remove foreign objects or paper, and then close the roll paper cover to make the printer recover from the error. The printer automatically recovers from the error if the blade can be unlocked easily, however, make sure to check for foreign objects before use.
Paper layout error	The loaded paper is different from the settings.	Remove the cause of the error and then send an error recovery command to make the printer recover from the error.

**NOTE**

Instead of closing the roll paper cover, you can make the printer recover from the error using a dedicated command, however, doing so will cause the printer to go offline due to a cover open error.

## Unrecoverable Errors

These include a high voltage error, CPU execution error, and communication unit error. If the error persists after turning the printer off and then on again, the printer may be defective. Contact your qualified service personnel.

**CAUTION**

If an unrecoverable error occurs, immediately turn off the power and remove the battery.

## NV Memory (Non-Volatile Memory)

The printer's NV memory stores data even after the printer power is turned off. NV memory contains the following memory areas for the user:

- NV graphics memory
- User NV memory
- Memory switches (customized values)
- Maintenance counter

### CAUTION

As a guide, NV memory rewriting should be used 10 times or less a day when you program applications.

### NV Graphics Memory

Graphics, such as shop logos to be printed on receipts, can be registered.

To register your graphics data, use TM-P80II Utility or ESC/POS commands.

You can check registered graphics data using TM-P80II Utility or by printing the data in the NV graphics information print mode.

### User NV memory

You can store and read text data for multiple purposes, such as for storing a note including customizing or maintenance information of the printer.

### Memory Switches (customized values)

With the memory switches, which are software switches for the printer, you can configure various settings of the printer.

For information about the memory switch, see "[Software Settings](#)" on page 59.

### Maintenance Counter

With this function, printer information, such as the number of lines printed, the number of autocuts, and printer operation time after the printer starts working, is automatically stored in printer's memory. You can read the counter information to use it for periodical checks or part replacement.

### NOTE

- You can also check the head running length and number of times of autocutting with the self-test (see "[Self-test Mode](#)" on page 73).
- The maintenance counter values are automatically saved in the NV memory usually every two minutes (up to four minutes). However, the values are not saved when the printer is in power-saving mode or when it is turned off without the use of the Power button.
- Do not remove the battery when the printer is on. Doing so will cause the maintenance counter value to be incorrectly updated.

## Useful Functions for Smart Devices

You can easily connect the printer to the network by using the NFC tag built-in to the printer or the QR code printed on the status sheet.

### NFC Tag

Bring a smart device that supports NFC close to the NFC tag to acquire the printer information (information for specifying the device).

By using the acquired information, the device can specify the printer to send a print job over a network or Bluetooth.

### QR Code

Capture the QR code printed on the status sheet with the camera on your smart device to acquire the printer information (information for specifying the device).

By using the acquired information, the device can specify the printer to send a print job over a network or Bluetooth.

#### NOTE

- Programming using Epson ePOS SDK is required to use these functions. These functions can be achieved by combining NFC touch and QR code scanning operations with the identification of target printers using the Printer Easy Selection API. See the "Epson ePOS SDK for Android/iOS User's Manual" and the Epson ePOS SDK sample program for more details. The sample program also contains a sample implementation method for reading an NFC tag and capturing a QR code.
- You can try a demo of these functions by using Epson TM Utility.



## Printing Using Multiple Interfaces

The printer offers multiple interfaces and allows you to use all of them without limitation. You can use this function to temporarily connect a smart device to a nearby printer and print.

The printer provides each interface with an independent receive buffer and switches the active interface depending on the priority, while handling data in each receive buffer.

You can set one interface for the main connection. Data received from the main connection interface is handled with the highest priority.

By default, the interface that first receives data is set as the main connection interface; however, you can select the main connection interface in advance.

When the receive buffer for the active interface becomes empty and a preset time period (one second by default) has passed, switching to another interface is enabled, and an interface that receives print data becomes active.

**CAUTION**

When you do not use the Bluetooth function, set the Bluetooth security level to "Middle" or "High" to prevent unauthorized access to the printer over Bluetooth. You can change the security level by using Epson TM Utility, TM-P80II Utility, or in the Interface Setup mode.

**NOTE**

You can select the main connection interface and set the time to enable interface switching from the software settings. For details on software settings, see "[Software Settings](#)" on page 59.

# Setup

This chapter describes the installation and setup procedures for the printer and peripheral devices required before using the printer.

## Placing or Hanging the Printer

The printer can be placed on a horizontal surface such as a desk or hung vertically from your belt using the belt clip of the printer.

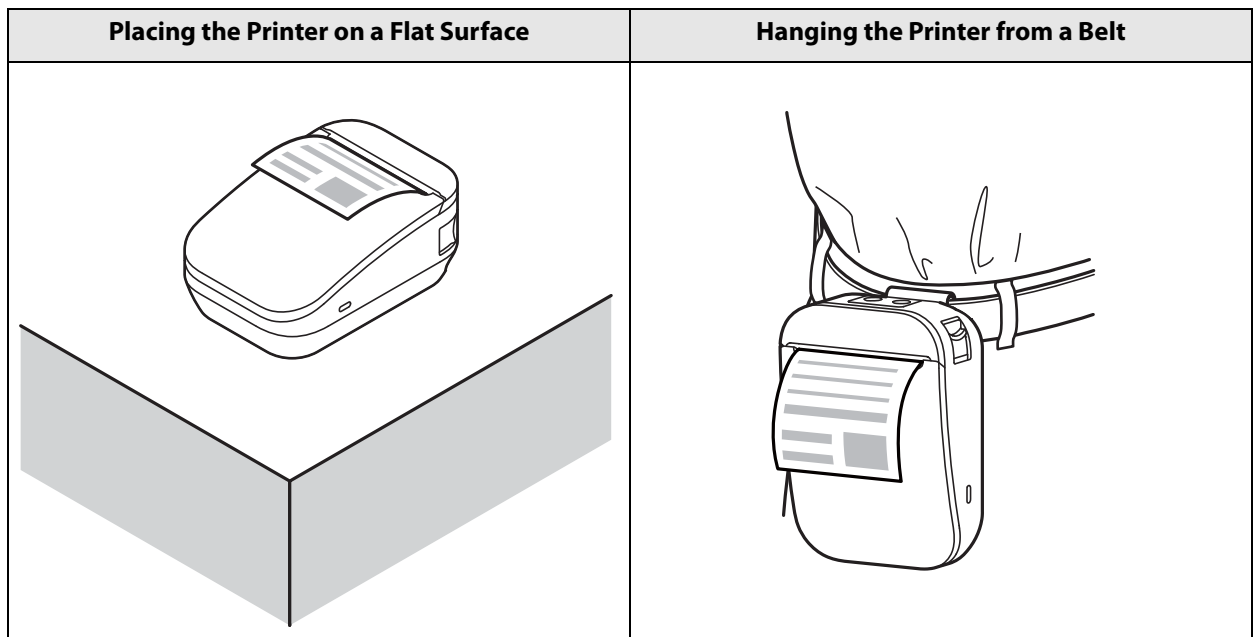

### Placing the Printer on a Flat Surface

When using the printer on a flat surface, it is recommended to remove the belt clip from the printer. Remove the belt clip as shown below.

**CAUTION**

Do not repeatedly attach and detach the belt clip. The screw hole may be damaged and the belt clip may not be securely fastened.

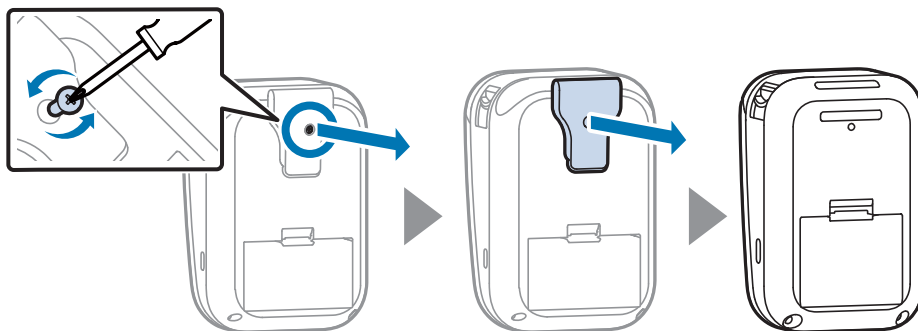

## Hanging the Printer from a Belt

By attaching the belt clip to your belt, you can hang the printer from your waist.

Hang the printer vertically with its operation panel facing up.

**CAUTION**

- Before use, make sure the belt clip is securely fastened to the printer and is not loose. Looseness may cause the printer to drop, resulting in injury or accident.
- Be careful not to drop the printer when hanging it with the belt clip.

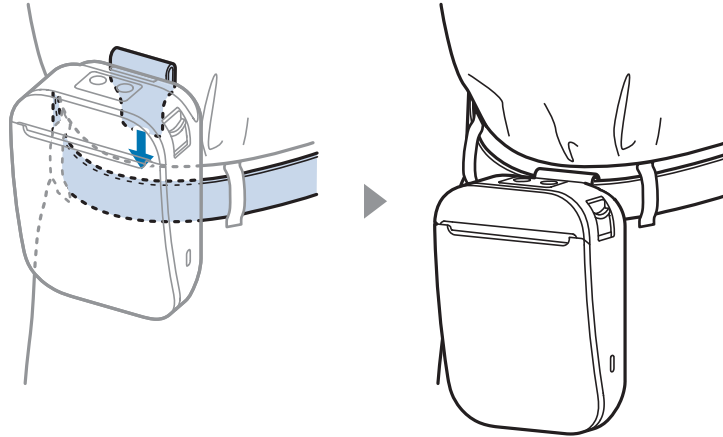

## Installing the Battery

The printer does not work without the battery installed.



Always use a OT-BY80II battery. Use of batteries other than OT-BY80II may result in fire, explosion, leakage, overheating, or other damage.

### CAUTION

- Be sure to turn off the printer before removing the battery.
- Dispose of used batteries according to your local instructions.

### How to Install the Battery

Insert the battery so that its tabs engage with the grooves on the printer, and fit it in until it clicks into place.

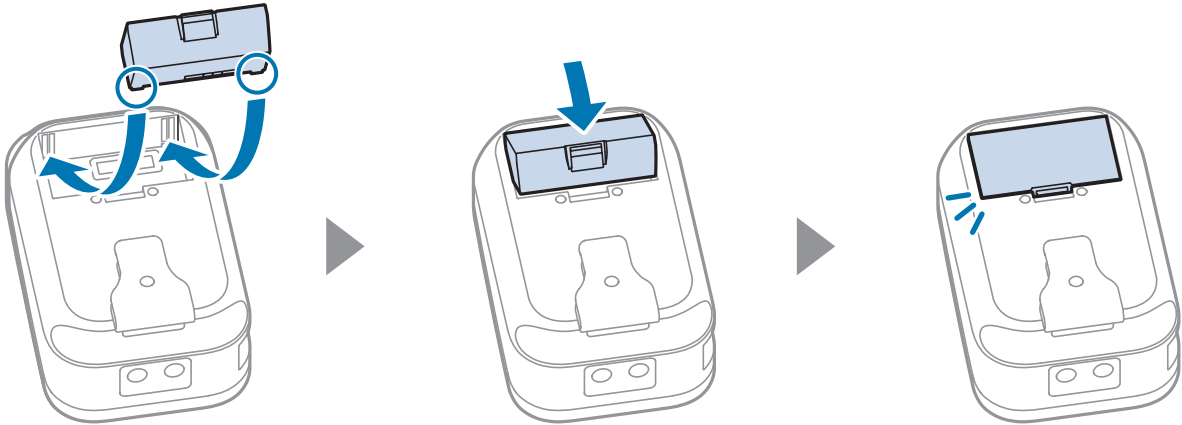

### NOTE

See "[Charging the Battery](#)" on page 37 for instructions on how to charge the battery.

### How to Remove the Battery

- 1 Turn off the printer.
- 2 While pushing the battery hook, raise the battery and remove it.

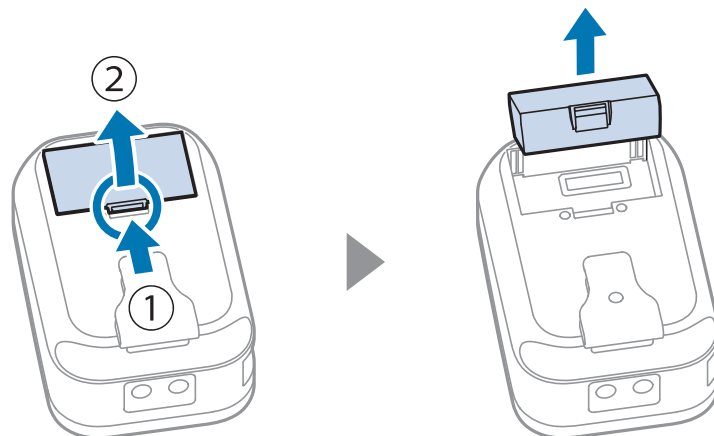

## Charging the Battery

### Charging the Battery using the Included USB Cable

#### CAUTION

- When charging the battery, install the battery to the printer.
- Charge the battery in an environment of approximately 0 to 40 °C (32 to 104 °F).

#### NOTE

- When the printer is used for the first time, the battery needs to be charged for approximately 2.5 hours.
  - Use a USB Type-C power adapter or USB port that complies with the USB Type-C Standard.
  - Only USB Type-C standard power mode is supported. The charging time varies depending on the power supply capability and settings of the USB power adapter and port.
- [📖 "Electrical Characteristics" on page 103](#)

- 1** Connect the included USB-C cable to the printer.
- 2** Connect the USB-C cable to a commercially available USB power adapter or computer.
- 3** The charge LED lights up when charging starts.  
If the battery level is close to full, charging will not start.  
Check the battery level with the battery LED.  
[📖 "Battery LED" on page 22](#)
- 4** The charge LED turns off when charging is complete.

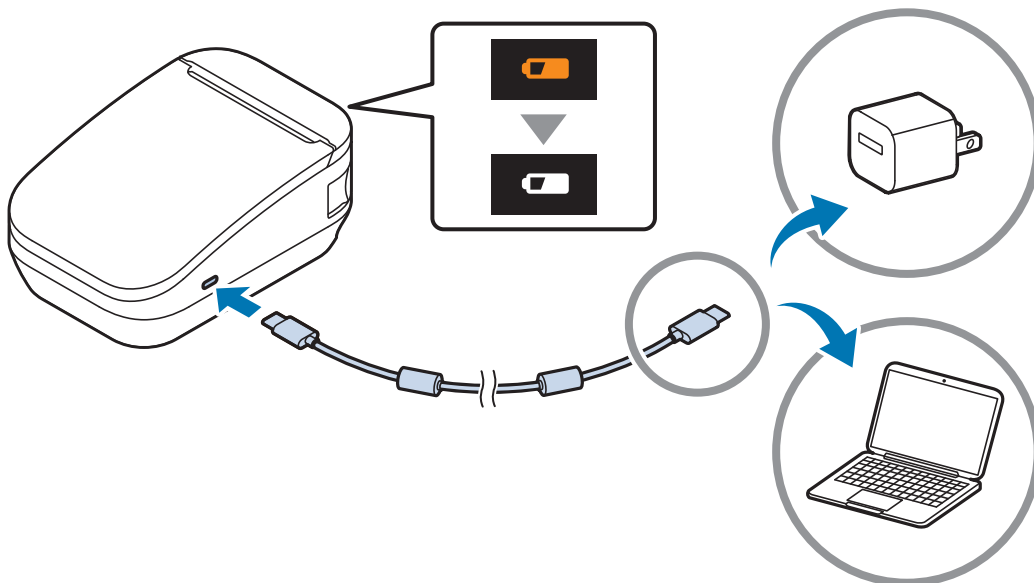

- 5** Disconnect the USB-C cable from the printer.

## Charging the Battery with the Optional Battery Charger

By using the optional battery charger, the battery removed from the printer can be charged alone.

### ❑ OT-SB80II

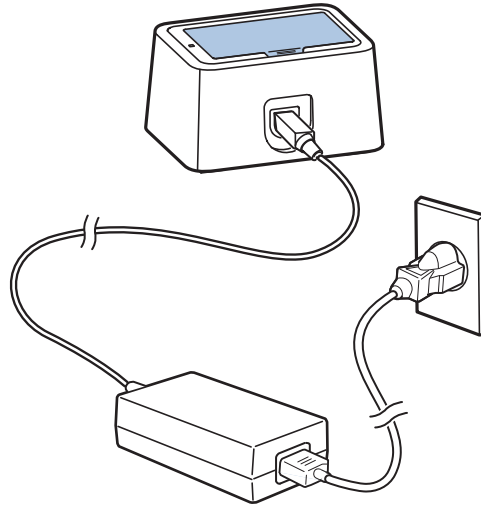

### ❑ OT-CH80II

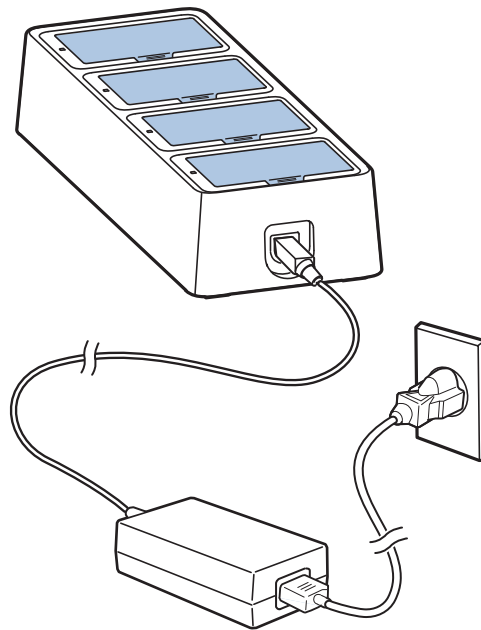

For more information, see the User's Manual of the battery charger from the link below.

[👉 https://www.epson-biz.com/?prd=ot-sb802&inf=manual](https://www.epson-biz.com/?prd=ot-sb802&inf=manual)

## Wireless Charging

The battery can be charged using a commercially available wireless charger that supports the Qi standard. Place the printer so that the  symbol (Wireless charging position) on the printer overlaps the position indicated in the wireless charger manual.

The charge LED lights up when charging starts. If the charge LED does not light up, reposition the printer in the correct position.

Check the battery LED for charge level.

 ["Battery LED" on page 22](#)

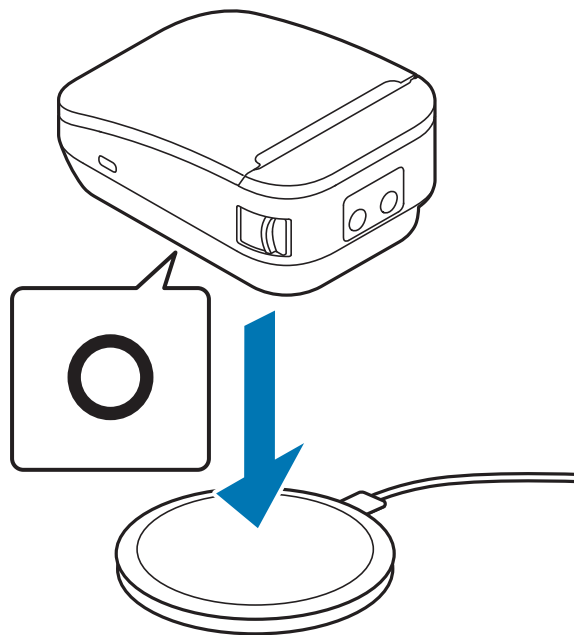



### Precautions for Wireless Charging

- For the procedure of wireless charging, refer to the manual of the wireless charger.
- Remove the belt clip when charging wirelessly.  
 ["Placing the Printer on a Flat Surface" on page 34](#)
- When charging wirelessly, remove the optional belt strap, shoulder strap, and soft case.
- When charging, be sure to correctly align the printer's wireless charging position with that of the wireless charger.
- Depending on the wireless charger used, the charging position may not match and charging may not be performed properly.
- Charging may stop if the temperature of the printer exceeds a certain level during charging.
- If you charge wirelessly while the printer is on, the charge LED will stay on.
- Be careful not to allow foreign objects to get between the printer and the wireless charger. Foreign objects may generate heat or cause damages, resulting in improper charging.
- Disconnect the USB-C cable when charging wirelessly. Wireless charging will not work if the printer is connected to a computer or other device.
- The charging time with wireless charging is as follows.  
3 to 6 hours (depending on the specifications of your wireless charger)



## Turning the Power On/Off

### Turning the Power On

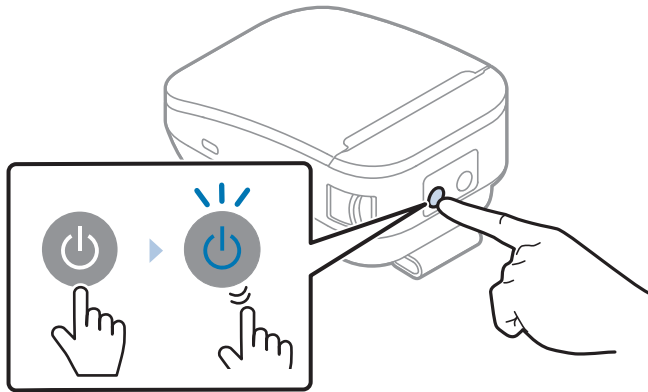
Press the  power button for about one second and release it when the  power LED lights up.



### Turning the Power Off

Press the  power button for about two seconds and release it when the  power LED goes off or starts flashing.

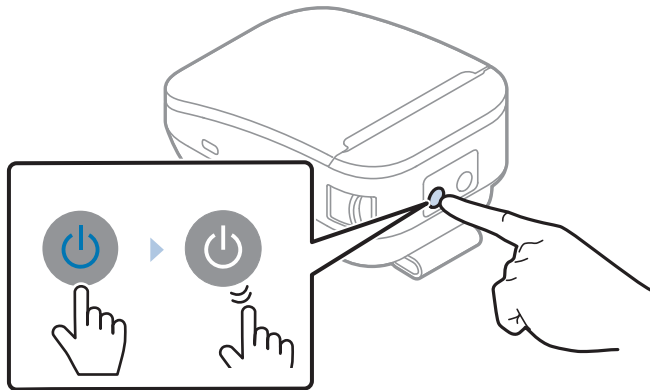



## Installing Roll Paper

### How to Open the Roll Paper Cover

Press the cover open lever to open the roll paper cover.

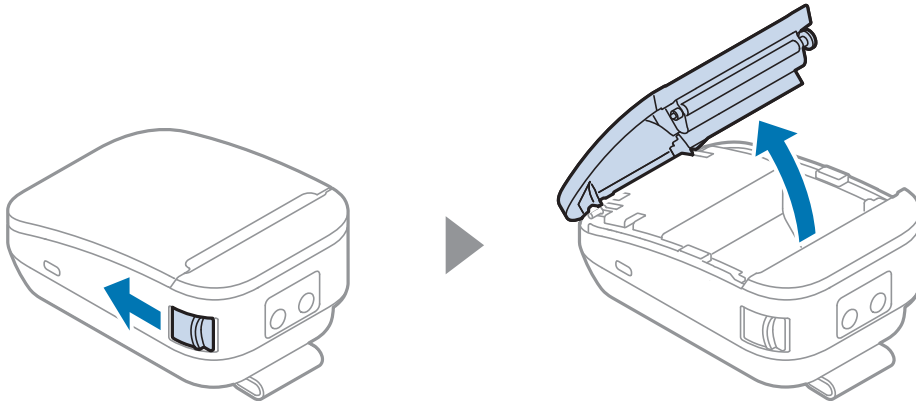
**CAUTION**

Be careful not to touch the protrusions on the roll paper cover. Your hands or clothes may be contaminated with oil.

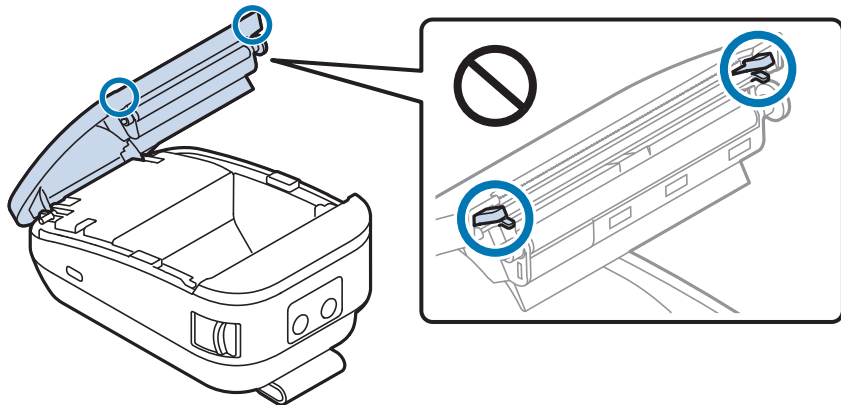

## How to Close the Roll Paper Cover

Press both sides of the roll paper cover and close it tightly until it clicks into place.

**CAUTION**

If both ends of the roll paper cover are not closed tightly, it may cause printing defects.

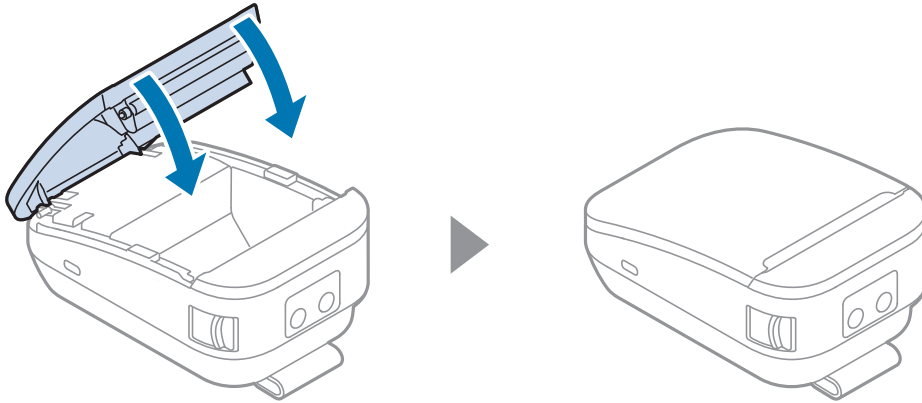

## Installing or Replacing the Roll Paper

Follow the steps below to install or replace the roll paper.

### CAUTION

- Make sure you use a specified roll paper type.
- Before installing the roll paper, take up any slack in the roll paper by pulling its leading edge. If you install a slack roll paper, a paper jam or print quality problems may occur.
- Before installing the roll paper, make sure that the roll paper is not deformed. Using a deformed roll paper will cause the printer to malfunction.

- 1 Turn on the printer.
- 2 Open the roll paper cover.  
[👉 "How to Open the Roll Paper Cover" on page 41](#)
- 3 Remove the used roll paper core if any.
- 4 Install the roll paper in the correct direction.

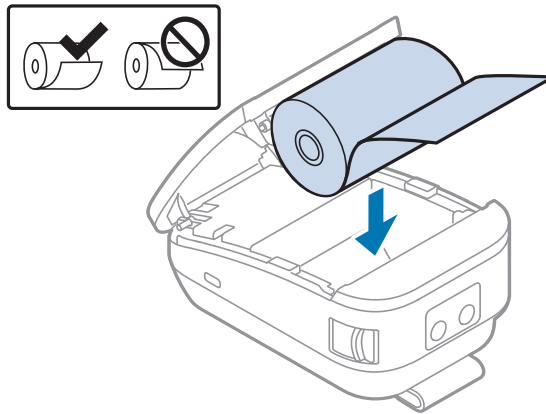

- 5 Pull out some paper, and close the roll paper cover.  
[👉 "How to Close the Roll Paper Cover" on page 42](#)  
 If the printer is turned on, the roll paper is automatically cut.

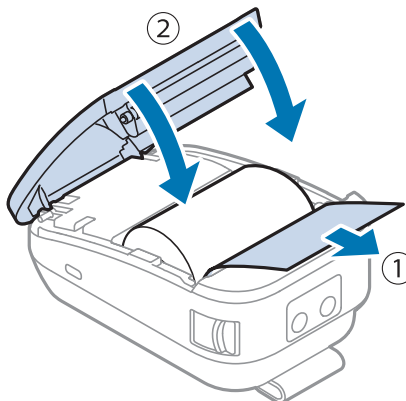

## Anti-Curl Function

The printer is equipped with the anti-curl function. The function reduces the curl of the roll paper after printing.

Disabling the anti-curl function speeds up printing.

### NOTE

When the remaining amount of roll paper is low and is about to reach the core, the anti-curl function declines.

### How to Disable the Anti-Curl Function

- 1 **Open the roll paper cover.**  
 ["How to Open the Roll Paper Cover" on page 41](#)
- 2 **Remove the roll paper in use, if any.**
- 3 **Remove the part for the anti-curl function as shown below.**

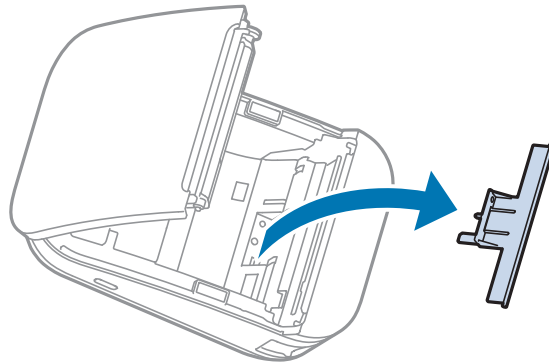

- 4 **Install the roll paper and close the roll paper cover.**  
 ["Installing or Replacing the Roll Paper" on page 43](#)

### NOTE

To activate the anti-curl function, install the part for the anti-curl function again.

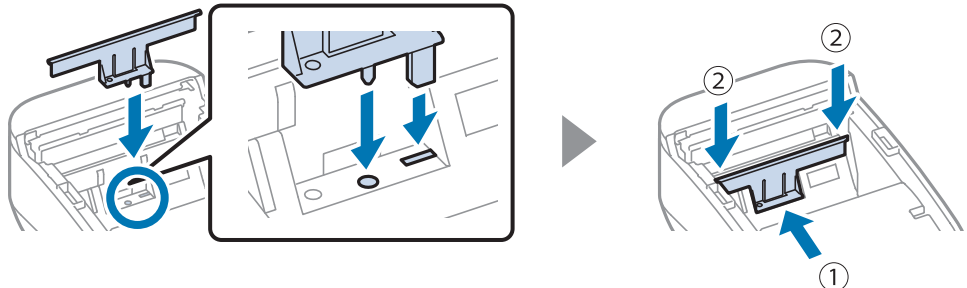

## Connecting the Printer to the Host Device

### USB Interface

When using the USB-C cable to connect with host device, connect the USB-C cable to the printer, and after starting the host device, turn the printer on.

#### CAUTION

- Do not place any weight or stress on the cable when using. Doing so could damage the cable and connectors.
- Use a USB-C cable that complies with the USB 2.0 standard. Using a non-compliant cable may cause the printer to malfunction due to static electricity.

### Bluetooth Interfaces (Bluetooth model)

Pair the printer with your device using the Bluetooth function of the device or using other methods.

Pairing the printer is also possible by using EPSON™ Bluetooth Connector (Windows) or Epson™ Utility (iOS or Android).

#### CAUTION

- If the host computer and the printer are not connected on a continuous basis but rather connected every time the printer starts printing, some time may be needed for the printer to actually start printing after the host computer commands printing. This pause is the time required for processing the connection between the host computer and the printer, and it depends on the conditions of the environment where used.
- If data transfer from an application of the host computer has already been completed, data might remain in the Bluetooth module internal buffer. Since data remaining in the buffer may be discarded when the connection is disconnected, when disconnecting the wireless connection immediately after printing, use status or other means to confirm that the transmitted data has been printed reliably.

#### NOTE

- The default device name is TM-P80II\_XXXXXX. The "XXXXXX" is the last 6 digits of the printer serial number. The device name can be edited using the TM-P80II Utility or Epson™ Utility.
- The default Bluetooth security level is "Middle". For information on the Bluetooth security settings, see ["Interface Setup Mode" on page 78](#).
- For details on the Bluetooth interface, see ["Bluetooth Interface \(Bluetooth model\)" on page 112](#).
- For detailed information about EPSON™ Bluetooth Connector, see the TM Bluetooth Connector User's Manual.

### Setting up from a Smart Device

How to connect a smart device to a printer via Bluetooth is also introduced in the video manual.

See ["Manuals for This Product" on page 10](#) for more details.

#### Necessary Items

Prepare the following items.

- Smart device for setting: iOS or Android device

## Setup Procedure

- 1** On your smart device, open the Bluetooth settings from Settings.
- 2** Turn on Bluetooth on the smart device.
- 3** Open the roll paper cover of the printer.
- 4** With the roll paper cover open, press and hold the Feed button for about one second until the buzzer sounds, then release it.
- 5** Close the roll paper cover.  
A guidance that starts with "Next Action" will be printed.
- 6** Select [Bluetooth Status sheet]. Briefly press the Feed button (less than one second), and then hold down the button for at least one second.  
A status sheet will be printed and the printer will be ready for pairing.
- 7** Select the same device name printed on the status sheet from the list of connectable devices on the smart device and pair it.
- 8** When you see that the printer is connected, the connection is complete.

**NOTE**

- The default setting of the Device Name printed on the status sheet is TM-P80II\_XXXXXX. "XXXXXX" is the last six digits of the printer serial number.
- You can make a test print by using Epson TM Utility.  
For more details about Epson TM Utility, see "[Interface Setup Mode](#)" on page 78.

---

## Setting up from a Windows Computer

Follow the procedure below and make the settings.

- 1** Have a Bluetooth wireless technology compatible computer ready.  
Make sure you have installed TM Bluetooth Connector.
- 2** Turn on the printer.
- 3** Open the roll paper cover of the printer.
- 4** With the roll paper cover open, press and hold the Feed button for about one second until the buzzer sounds, then release it.
- 5** Close the roll paper cover.  
A guidance that starts with "Next Action" will be printed.

- 6** Select [Bluetooth Status sheet]. Briefly press the Feed button (less than one second), and then hold down the button for at least one second.

A status sheet will be printed and the printer will be ready for pairing.

- 7** Start TM Bluetooth Connector.

- 8** Select [Search all printers around this computer], and then click [Search].

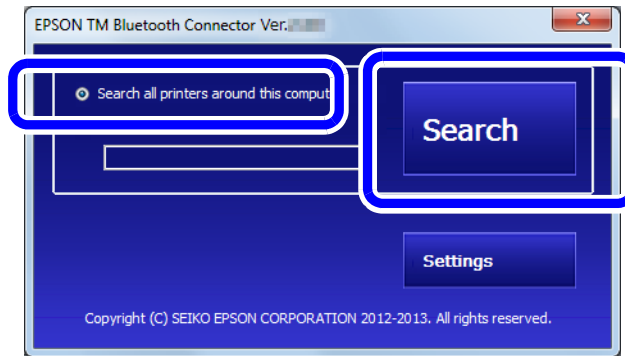

**NOTE**

If the printer has not detected after clicking the Search button, check the manufacturer of the Bluetooth software.

1. Open the Control Panel.
2. In the search box on the Control Panel, enter "Bluetooth", and then click Change Bluetooth settings.
3. In the Bluetooth Settings dialog box, click the Hardware tab, and then search for the Microsoft Bluetooth Enumerator.

If it is not found, the Bluetooth software cannot detect the Epson Bluetooth printer, and you may not be able to connect to the computer.

- 9** Select the printer to be paired, and then click [Connect].

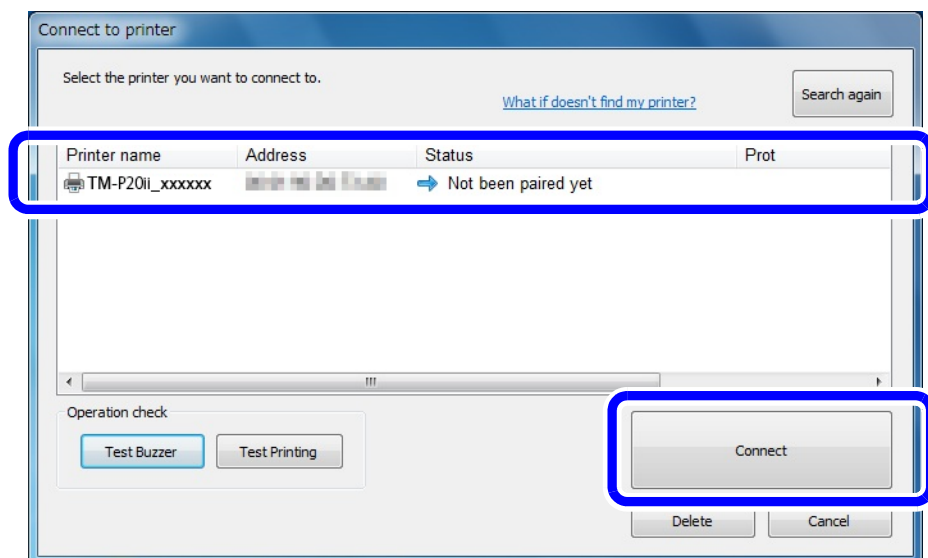

- 10** Select the port to be used from the pull-down list, and then click [OK].

- 11 The "Connection complete" window appears. Click [Test Buzzer] or [Test Printing] to check operation.
- 12 Click [Back to Main screen] to return to the main window.
- 13 Click the "x" button of TM Bluetooth Connector to exit.

**NOTE**

- If "Error" is displayed when you click the [Search] on the TM Bluetooth Connector, check whether:
  - \* The Bluetooth adapter is installed to the computer.
  - \* Bluetooth is ON in the Windows settings.
- If the device is not displayed on the TM Bluetooth Connector or the TM Bluetooth Connector Status shows "✘" after pairing, check the following.  
Check whether:
  - \* Make sure the printer is turned on.
  - \* Make sure the printer is no more than 10 meters away from the computer.
  - \* Confirm that there is no other wireless device, such as a microwave oven and cordless telephone, that can interfere with the Bluetooth printer.
  - \* If the printer and the computer are placed in different rooms separated by a wall, move the printer and/or the computer in the same room.
  - \* The printer may not be detected when the search time is short. Try search again with longer search time.
  - \* While a computer and printer are communicating, the printer cannot be detected by other computers. Confirm that the printer to be detected is not communicating with any computer.



## Wi-Fi Interface (Wi-Fi model)

The printer has "SimpleAP" mode that allows a device to directly connect to the printer without using an access point. This makes it easy to set up a printer to connect to a wireless LAN using the printer setting tool, without having to go through a network environment such as an access point.

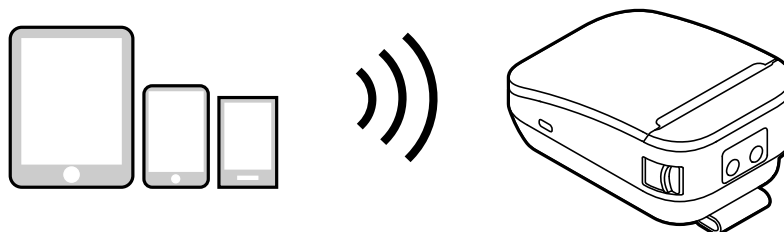

### CAUTION

- When you set up the access point at the same time, set the access point in advance and check that it operates correctly.
- If the SSID of the access point to which the printer is connected is "EpsonNet", the printer cannot be connected. Change the SSID to a name other than "EpsonNet".  
Note that the default SSID of the printer is "EpsonNet". The SSID will return to "EpsonNet" when the printer is initialized using the initialization menu in Interface Setup Mode.
- Examine the radio wave situation in the surrounding area before use.
- Avoid using the same channel that is used in the neighboring shops where Wireless LAN is used.
- When using the printer in environments where kitchen microwaves and other devices that may interfere radio waves are installed, observe the following points.
  - \* Keep the printer away from the devices, such as kitchen microwaves, that may cause radio wave interference.
  - \* Use channels that are away from the frequency bands that may cause radio wave interference.
  - \* Place shields between the printer and the devices that may cause radio wave interference.
  - \* Select either 2.4 GHz or 5 GHz, whichever is free from radio wave interference.
  - \* In auto channel setting for the access point, do not select a channel in which the devices may cause radio wave interference.

## About SimpleAP (Wi-Fi Direct)

- The printer acts as an access point in the SimpleAP mode and allows up to eight devices to connect to the printer. However, devices directly connected to the printer cannot communicate with each other through the printer.
- The printer can be connected with SimpleAP while being connected to a wireless LAN. However, if the printer is already connected to a wireless LAN and setting using the SimpleAP mode is started, the wireless LAN connection is temporarily disconnected.
- Since the default IP address of SimpleAP is 172.16.10.1, do not use 172.16.x.x as the IP address for the wireless LAN. If you use it, the SimpleAP function will stop to avoid IP address conflicts. However, if you restart SimpleAP in the above state, you can start SimpleAP with IP address conflict avoided.
- Even if you have not changed your passphrase, you may be prompted to enter your passphrase. In that case, enter the serial number of the printer.

## Starting the Printer in the SimpleAP Mode

The printer is shipped from the factory with the SimpleAP enabled.

The printer automatically starts in the SimpleAP mode and prints the "SimpleAP Start" sheet when it is turned on with the following conditions; SimpleAP enabled, not connected to a wireless LAN/USB device, and wireless LAN settings have not been configured.



### NOTE

You can also manually start the printer in the SimpleAP mode.

["Interface Setup Mode" on page 78](#)

["Printing a Status Sheet" on page 84](#)

The procedure for starting the printer in the SimpleAP mode using the status sheet printing function is as follows.

- 1 Turn on the printer.**
- 2 Open the roll paper cover.**
- 3 Install the roll paper.**
- 4 With the roll paper cover open, press and hold the Feed button for about one second until the buzzer sounds, then release it.**
- 5 Close the roll paper cover.**  
A guidance that starts with "Next Action" will be printed.
- 6 Select "5:SimpleAP". Press the Feed button briefly (less than one second) five times, and then hold down the button for at least one second.**  
The printer will start in the SimpleAP mode and print "SimpleAP Start" sheet.

## Setting up using Web Config

Start the printer in the SimpleAP mode and connect to a wireless LAN using Web Config. Web Config is a printer's built-in web page that allows you to check and change printer settings on your browser.

### NOTE

How to connect a smart device to a printer via wireless LAN is also introduced in the video manual. See "[Manuals for This Product](#)" on page 10 for more details.

### Necessary Items

Prepare the following items.

- A device for the setup which has a web browser.

### Setup Procedure

#### 1 Start the printer in the SimpleAP mode.

The "SimpleAP Start" sheet is printed.  "[Starting the Printer in the SimpleAP Mode](#)" on page 50



#### 2 Scan the QR code on the sheet with the device for setup.

#### 3 Select the SSID printed on the sheet on the "Wi-Fi" screen of the device.

Web Config screen will be automatically displayed.

### NOTE

If the QR code cannot be scanned or the screen is not displayed, start your web browser on the device and enter the IP address of the printer in the address field.

#### 4 Select the [Wi-Fi] menu.

#### 5 Enter the password and select "OK" to log in to Web Config.

The default password is the serial number of the printer. The serial number is printed on the "SimpleAP Start" sheet.

### NOTE

The password can be changed from "Change Administrator Password" in the Product Security tab of Web Config.

#### 6 From the list of SSIDs displayed, select the SSID of the network you want to connect to.

#### 7 Enter your network password and select "OK".

When the Wi-Fi LED lights up, the connection is complete.

---

## Setting up using Epson TM Utility

Start the printer in the SimpleAP mode and connect to a wireless LAN using the TM Utility.

### Necessary Items

Prepare the following items.

- Smart device for setting: iOS or Android device
- Utility for setting: Epson TM Utility

### Setup Procedure

- 1** Start the Epson TM Utility.



- 2** Select [Wi-Fi Setup Wizard] from the menu.
- 3** Select the printer model name.
- 4** Select [Next]. Instructions for starting SimpleAP (Wi-Fi Direct) will be displayed. Follow the instructions to start SimpleAP.

Then, follow the on-screen instructions to complete the setup.

---

## Setting up using TM-P80II Utility

Connect the printer and computer with a USB cable, and configure the printer's wireless LAN settings on the computer using the TM-P80II Utility.

### Necessary Items

Prepare the following items.

- Computer: Windows 11/10/8.1/8/7
- USB cable: With a Type-C connector required for connecting to the printer
- Setup utility: TM-P80II Utility

### Setup Procedure

- 1** Connect the printer to the computer with a USB cable.
- 2** Turn on the computer.
- 3** Turn on the printer.
- 4** Start TM-P80II Utility.
- 5** Select the printer and click [OK].  
If the printer does not appear, click the [Add Port] button to add the USB-connected printer.
- 6** Use the [Network] menu to configure the network settings.  
For details on the settings, refer to the TM-P80II Utility manual.
- 7** After completing the settings, turn off the printer.

Wireless LAN setup for the printer is now completed.

# Handling

## Cleaning

### Cleaning the Printer Case

If the exterior surface is noticeably dirty, follow the steps below to clean it.

**CAUTION**

Never clean the product with alcohol, benzene, thinner, or other such solvents. Doing so may damage or break the parts made of plastic and rubber.

- 1 Turn off the printer.**
- 2 Disconnect the USB-C cable, if it is connected.**
- 3 Wipe off the dirt with a dry or slightly damp cloth.**

## Cleaning the Thermal Head

Epson recommends cleaning the thermal head to maintain receipt print quality. We recommend cleaning periodically (about once every 3 months).

**CAUTION**

- After printing, the thermal head and its surroundings can be very hot. Be careful not to touch it and to let it cool before you clean it.
- Do not damage the thermal head by touching it with your fingers or any hard object.

- 1 Turn off the printer.**
- 2 Disconnect the USB-C cable, if it is connected.**
- 3 Open the roll paper cover and then remove roll paper.**
- 4 Clean the thermal head with a cotton swab moistened with alcohol solvent (ethanol or isopropyl alcohol).**

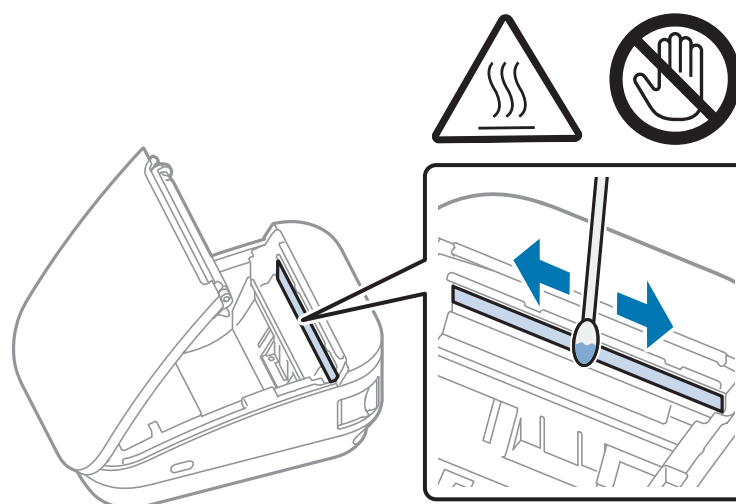

- 5 When the cleaned area is completely dry, load the roll paper and close the roll paper cover.**

## Cleaning the Platen Roller and Paper Detector

Depending on the roll paper used, paper dust may stick to the platen roller and the paper may not be fed correctly. Follow the procedure below to remove the paper dust.

To maintain receipt print quality, we recommend cleaning the platen roller and the paper detector periodically (about once every 3 months).

- 1 Turn off the printer.**
- 2 Disconnect the USB-C cable, if it is connected.**
- 3 Open the roll paper cover and then remove roll paper.**
- 4 Use a cotton swab lightly moistened with water to remove paper dust from the platen roller and paper detector.**

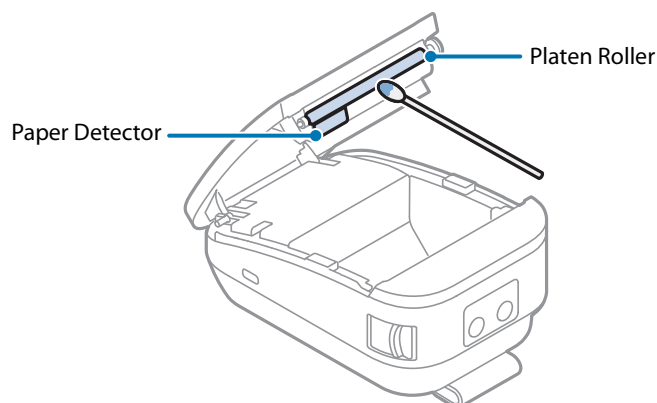

- 5 When the cleaned area is completely dry, load the roll paper and close the roll paper cover.**



## Troubleshooting

### When the Roll Paper Jams

When a paper jam occurs, never pull out the paper with too much force. Open the roll paper cover and remove the jammed paper.

Follow the procedure below to remove jammed paper.



Do not touch the thermal head and its surroundings. They may be hot immediately after printing.

#### CAUTION

If you touch paper during printing or before cutting operation is finished, a paper jam or auto cutter error (unable to cut) may occur.

- 1** Turn off the printer.
- 2** Disconnect the USB-C cable, if it is connected.
- 3** Open the roll paper cover.
- 4** Remove the jammed paper.
- 5** Install the roll paper and close the roll paper cover.

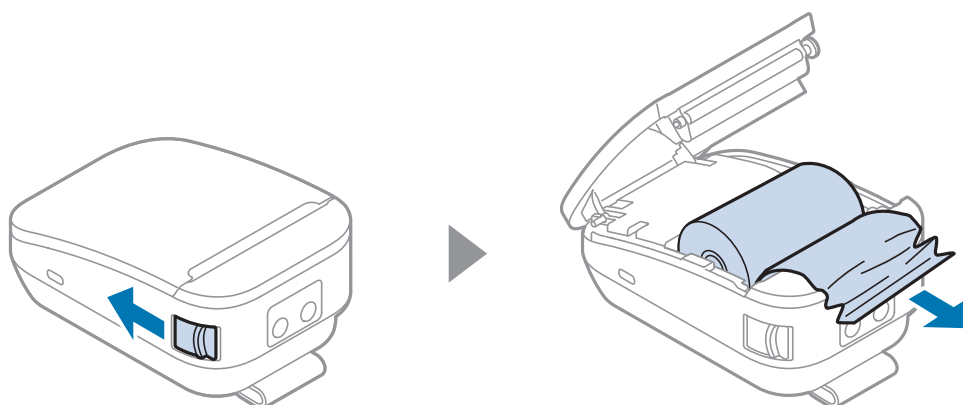

### When the Roll Paper Cover dose Not Open

If the roll paper cover does not open even after pulling the cover open lever, turn the printer off and then on again.

## Printout is Faint

If your print out is faint or banding appears as shown below, the thermal print head may be stained badly. Clean the thermal print head and check that the problem is solved.

 "Cleaning the Thermal Head" on page 55





 "Cleaning the Platen Roller and Paper Detector" on page 56



## Cannot Print

If you cannot print from the printer even though no errors have occurred, run a self-test to see if you can print with the printer alone. If the printer is connected to a computer or smart device via Wi-Fi or Bluetooth, check the Wi-Fi LED or Bluetooth LED to see if they are connected properly.

Follow the steps below.

- 1** Close the roll paper cover.
- 2** While pressing the  Feed button, turn on the printer. (Hold down the  Feed button until printing starts.)  
After printing the current print status, a continuing self-test guidance is printed, and the  power LED flashes.
- 3** Briefly press the  Feed button (less than one second) to continue the self-test.  
The printer prints using the built-in character set.  
After "\*\*\* completed \*\*\*" is printed, the printer is reset and switches to standard mode.

# Advanced Usage

## Software Settings

The printer offers memory switches and customized values which allow you to make various settings for the printer.

The settings can be made in any of the methods listed in the table below or by using the ESC/POS commands.

For an explanation of each function and setting, see ["Overview of Each Function" on page 60](#).

**NOTE**

- The Software Setting Mode allows you to make the settings by operating the buttons on the printer. For instructions on how to operate the buttons, see ["Software Setting Mode" on page 75](#).
- For the settings that can be set by the ESC/POS commands and how to set them, refer to the ESC/POS Command Reference. For more details, see ["Application Development Information" on page 88](#).

Item \ Method	Software Setting Mode	TM-P80II Utility TM Utility	Web Config (Wi-Fi model)
Print Density	✓	✓	✓
Print Speed	✓	✓	✓
Automatic Paper Reduction	✓	✓	✓
Auto Paper Feed&Cut at cover close	✓	✓	
Default Character Code Page	✓	✓	
Default International Character Set	✓	✓	
Thai Character Composition	✓		
Embedded Font Replacement	✓		
Multi-Language Font	✓		
Font Priority	✓		
Interface Selection	✓	✓	
USB Interface Settings	✓	✓	✓
Interface switch waiting time	✓	✓	
Main connection interface	✓	✓	
Auto Line Feed	✓	✓	
Output Paper-end Signals	✓	✓	
Error Signal Output	✓	✓	
Command Execution (Offline)	✓	✓	✓
Column Emulation	✓	✓	

Item \ Method	Software Setting Mode	TM-P80II Utility TM Utility	Web Config (Wi-Fi model)
NV Capacity	✓		
Buzzer Control	✓	✓	✓
Transmission of status information	✓	✓	
Auto power off	✓	✓	
Paper Position at Power On	✓	✓	
Resizing method for graphic data scaling		✓	
Batch rotate print (Upside Down)		✓	
Method for canceling recoverable error		✓	
Handshaking (Condition for BUSY)		✓	
Battery charge mode		✓	
Operation mode when battery is low		✓	
Desktop Mode	✓	✓	
Black mark control		✓	
Black mark gap		✓	
Cover closure action for BM receipt		✓	
Feed switch action for BM receipt		✓	
Distance from BM to the print starting position		✓	
Distance from BM to the cutting position		✓	

## Overview of Each Function

### Print Density

#### Monochrome

Selectable from 70 to 130% (5% increment)

Initial setting: 100%

To ensure good print quality, it is recommended to set the print density according to the paper used. See "[Paper Specifications](#)" on page 98 for setting instructions.

#### NOTE

- When the print density level is increased, print speed may be reduced.
- When print density is increased, paper dust tends to adhere to the print head surface, which may cause printing defects such as blurred prints.

## Print Speed

Selectable from levels 1 to 10 (Slow ~ Fast)

Initial setting: level 10

### NOTE

Depending on print conditions, such as print duty, print head temperature, and data transmission speed, print speed is automatically adjusted, which may cause white lines due to intermittent print (the motor sometimes stops). To avoid this, keep the print speed constant by setting it lower.

## Automatic Paper Reduction

### Upper Margin

- Enable
- Disable (initial setting)

### Lower Margin

- Enable
- Disable (initial setting)

### Blank Line Spacing (Line space reduction rate)

- 25%
- 50%
- 75%
- Not reduced (initial setting)

### Blank Space (Line feed reduction rate)

- 25%
- 50%
- 75%
- Not reduced (initial setting)

### Barcode Height (Barcode height reduction rate)

- 25%
- 50%
- 75%
- Not reduced (initial setting)

### Character Hight (Character height reduction)

- 75% reduction of inner spacing
- 75% reduction of inner spacing and shrinking the character height
- Not reduced (initial setting)

### NOTE

- No reduction is applied to blank dot lines that exist in a graphic data.
- Reduced barcodes are not guaranteed to be correctly scanned. Make sure to check whether they are properly read by a barcode reader that is actually used.

---

## Auto Paper Feed&Cut at cover close

- Enable (Cut) (initial setting)
- Disable (Not cut)

---

## Character/Font Settings

### Default Character Code Page

Selectable from 43 pages including user defined page

Initial setting: PC437: USA, Standard Europe

### Default International Character Set

Selectable from 18 sets

Initial setting: USA

### Thai Character Composition

- 3 pass
- 1 pass (initial settings)

### Embedded Font Replacement

#### Font A Replacement

- Does not replace (initial setting)
- Font B
- Font C
- Special Font A
- Special Font B

#### Font B Replacement

- Font A
- Does not replace (initial setting)
- Font C
- Special Font A
- Special Font B

#### Font C Replacement

- Font A
- Font B
- Does not replace (initial setting)
- Special Font A
- Special Font B

### Multi-Language Font

- Thai, Vietnam (initial setting)
- Simplified Chinese

## Font Priority

- ANK
- Japanese (initial setting)
- Simplified Chinese
- Traditional Chinese
- Korean

---

## Interface Selection

- Bluetooth (Bluetooth model)
- Built-in USB
- Wi-Fi (Wi-Fi model)
- Multiple (initial setting)

---

## Interface Settings

### USB Interface Settings

#### Class

- USB vendor-defined class (initial setting)
- USB printer class

#### IEEE1284 Device ID

- Do not output IEEE1284 Device ID
- Output IEEE1284 Device ID (initial setting)

#### USB power-saving function

- Enable
- Disable (initial setting)



The USB power-saving function is valid only when the USB interface communication condition is set to the vendor-defined class and the system configuration allows the USB driver to support the USB power-saving function.

### Interface switch waiting time

Select the number of seconds from 1 to 10 in increments of 1 second, or 60 seconds.

Initial setting: 10 seconds

---

## Main connection interface

- Built-in USB
- Bluetooth (Bluetooth model)
- Wi-Fi (Wi-Fi model)
- Auto (An interface that received data first) (initial setting)
- None (No main connection I/F)

**CAUTION**

- When using this printer with multiple interfaces, make sure the interface that is always connected to be set as the main connection.
- When you do not use the Bluetooth function, set the Bluetooth security level to "Middle" or "High" to prevent unauthorized access to the printer over Bluetooth. You can change the security level by using Epson TM Utility, TM-P80II Utility, or in the Interface Setup mode.

The “Auto” setting allows you to use the first interface you communicate with as the main connection and the other interfaces as secondary connections after you turn on the printer. For the limitations on the main connection and secondary connections, see the table below.

Connection Interface	Connection Priority	ESC/POS Command Restrictions	Retaining of Print Settings When Connection Is Terminated
Main connection	High	No	Retained
Secondary connection	Low	Yes*	Initialized

\*For details, see the ESC/POS Command Reference.

**NOTE**

- The displayed items vary depending on the interface configuration.
- For information about the function, see ["Printing Using Multiple Interfaces" on page 33.](#)

---

## Auto Line Feed

- Always disabled (initial setting)
- Always enabled

---

## Output Paper-end Signals

- Enable (Roll paper end detection) (initial setting)
- Disable

---

## Error Signal Output

- Enable (initial setting)
- Disable

---

## Command Execution (Offline)

- Enable (initial setting)
- Disable

---

## Column Emulation

- 48 column mode (standard column mode) (initial setting)
- 42 column mode



---

## NV Capacity

### User NV Memory

- 1 KB (initial setting)
- 64 KB
- 128 KB
- 192 KB

### NV Graphics Memory

- None (0 KB)
- 64 KB
- 128 KB
- 192 KB
- 256 KB
- 320 KB
- 384 KB (initial setting)

---

## Buzzer Control

### Low battery warning (Buzzer sounds for low battery warning)

- Enable
- Disable (initial setting)

### Roll paper end warning (Buzzer sounds for roll paper end warning)

- Enable
- Disable (initial setting)

### Error occurrence warning (Buzzer sounds for error occurrence warnings)

- Enable
- Disable (initial setting)

---

## Transmission of status information

- Enable
- Disable (initial setting)

**NOTE**

The status information includes power on notification, power off notification, and battery status notification.

---

## Auto power off

- Enable (20 minutes)
- Disable (initial setting)

**NOTE**

- Using the TM Utility, TM-P80II Utility, or the ESC/POS command, it can be set in the range of 0 (disabled) to 60 minutes in 1-minute increments.
- When the USB interface is connected, this setting is disabled (no auto power off).
- For details on the auto power off function, see ["Auto Power-Off" on page 24](#).

---

## Paper Position at Power On

### Function Select

- Enabled
- Disabled (initial setting)

### Position Select

- Cut Position
- Top Position (initial setting)

**NOTE**

This menu allows you to set the paper position immediately after closing the roll paper cover, resetting the printer, or turning on the printer.

---

## Resizing method for graphic data scaling

Select the resizing method for graphic data scaling.

- None (initial setting)
- Auto
- Manual

### Algorithm

- Simple thinning
- Nearest neighbor
- Bilinear
- Bicubic

### Scaling factor for manual adjustment

50 to 200%

---

## Batch rotate print (Upside Down)

When this function is enabled, each receipt is rotated 180 degrees and printed.

- Enable
- Disable (initial setting)

---

## Method for canceling recoverable error

- Command and Cover Close (initial setting)
- Command Only

---

## Handshaking (Condition for BUSY)

- Offline or Receive buffer full (initial setting)
- Receive buffer full

---

## Battery charge mode

- Mode 1 (initial setting)
- Mode 2

**NOTE**

For detailed information about the battery charge mode, see ["Battery Charge Mode" on page 24](#).

---

## Operation mode when battery is low

- Mode 1 (initial setting)
- Mode 2

**NOTE**

For detailed information about the operation mode when battery is low, see ["Operation Mode When Battery is Low" on page 25](#).

---

## Desktop Mode

- Disable (initial setting)
- Enable

**NOTE**

For details on the Desktop Mode, see ["Desktop Mode" on page 26](#).

---

## Black mark control

Enables/disables a function that detects black marks on paper.

- Disable (initial setting)
- Enable

---

## Black mark gap

Sets the length between black marks.

0, 28.4 to 310.0 mm

---

## Cover closure action for BM receipt

Selects the operation when the BM receipt is loaded in the printer and the cover is closed.

- No action (initial setting)
- Perform auto paper cut when cover close

---

## Feed switch action for BM receipt

Selects the operation when the BM receipt is used and the Feed switch is pressed.

- Feed paper to next start position (initial setting)
- Feed paper to next cut position and perform autocut

---

### **Distance from BM to the print starting position**

Sets the length from a black mark to the print starting position.

-5.6 to 300.0 mm

---

### **Distance from BM to the cutting position**

Sets the length from a black mark to the cutting position.

-13.7 to 5.0 mm

## Paper Layout Setting

When using roll paper with black marks, layout information such as the type and size of paper to be printed must be set in the printer.

You can make settings for paper type and size in Paper layout setting. Paper type is set to Receipt paper (without black mark) as default.

In case of using the Receipt paper (with black mark), you must select the Receipt paper (with black mark) for paper type.

When the paper layout setting and the actual paper you are using do not match, the following situations may occur.

- When Paper Type Setting is set to Receipt paper (without black mark) and receipt paper (with black mark) is used, the printer detects paper out.
- When Paper Type Setting is set to Receipt paper (with black mark) and receipt paper (without black mark) is used, a paper error occurs.

To make the Paper Layout Setting, there are following options available.

- Setting with the EPSON Advanced Printer Driver (APD)  
Set the size of the paper that you are using correctly.
- Setting with the OPOS  
See the “PTR\_DI\_SET\_PAPERLAYOUT” method” of your driver’s Application Development Guide for details to make the settings.
- Setting with the ESC/POS command  
See the “FS ( L <fn=33>” (Paper layout setting) of ESC/POS Command Reference for details to make the settings.
- Setting with the Epson ePOS SDK  
See “addLayout” method in Epson ePOS SDK User's Manual.

**NOTE**

- For detailed information about the driver, see ["Drivers" on page 90](#).
- For detailed information about downloading the software and manuals, see ["Download" on page 91](#).

## *MAC Address Confirmation*

You can check the printer's MAC address using the following procedures.

- Printing the status sheet
- Print a Self-test
- Using a Web browser to confirm (Web Config function)

## Setting/Check Modes

As well as print mode, the following modes are also provided for making various printer settings and checking items.

- Self-test mode
- NV graphics information print mode
- Software settings mode
- Restore default values mode
- Interface setup mode
- Radio field intensity check mode (Wi-Fi model)
- Hexadecimal dumping mode

The self-test mode or hexadecimal dumping mode is selected depending on the operation performed when the power is turned on.

NV graphic information print mode, Software settings mode, and Restore default settings mode are selected depending on the Feed button operation performed during a self-test.

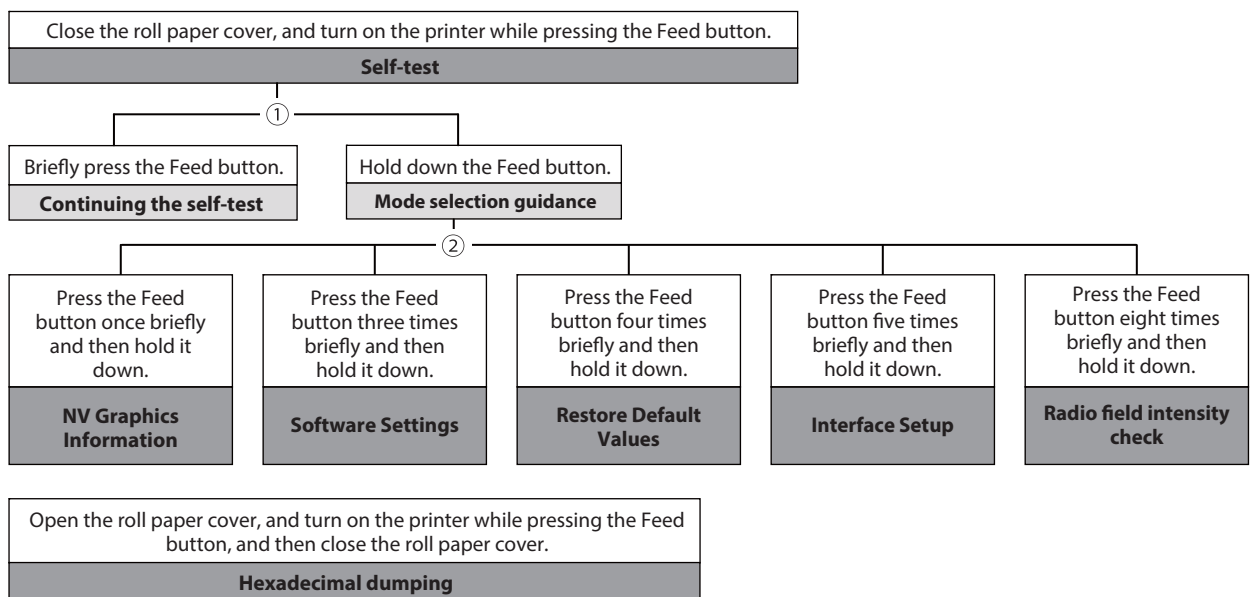

In 1 and 2, the following guidances are printed, the Power LED flashes, and instructs the user's operations.

1. Continuing self-test guidance

```
Select Modes by pressing Feed Button.  
Continue SELF-TEST: Less than 1 second  
Mode Selection      : 1 second or more
```

2. Mode selection guidance

Wi-Fi model

Mode Selection

Modes

- 0: Exit and Reboot Printer
- 1: NV Graphics Information
- 3: Customize Value Settings
- 4: Restore Default Values
- 5: Interface Setup
- 8: Radio Field Intensity Check
- More than above: None

Select Modes by executing following procedure.

- step 1. Press the Feed button less than 1 second as many times as the selected mode number.
- step 2. Press Feed button for 1 second or more.

Bluetooth model

Mode Selection

Modes

- 0: Exit and Reboot Printer
- 1: NV Graphics Information
- 3: Customize Value Settings
- 4: Restore Default Values
- 5: Interface Setup
- More than above: None

Select Modes by executing following procedure.

- step 1. Press the Feed button less than 1 second as many times as the selected mode number.
- step 2. Press Feed button for 1 second or more.



## Self-test Mode

You can check the following items using the self-test.

- Product name
- Firmware version
- Product serial number
- Interface type
- Handshaking (Condition for BUSY)
- Resident fonts
- Thai Character Composition
- Auto Line Feed
- Print Density
- Recovery Point
- Maintenance counter information (head running length, number of times of autocutting)

Follow the steps below. You can also run the self-test using the ESC/POS commands.

- 1 Close the roll paper cover.**
- 2 While pressing the Feed button, turn on the printer. (Hold down the Feed button until printing starts.)**

After printing the current print status, a Continuing self-test guidance is printed, and the power LED flashes.
- 3 Briefly press the Feed button (less than one second) to continue the self-test.**

The printer prints a rolling pattern on the roll paper, using the built-in character set.  
After "\*\*\*\* completed \*\*\*" is printed, the printer initializes and switches to standard mode.

## NV Graphics Information Print Mode

Prints the following NV graphic information registered to the printers.

- Capacity of the NV graphics
- Used capacity of the NV graphics
- Unused capacity of the NV graphics
- Number of NV graphics that are registered
- Key code, number of dots in X direction, number of dots in Y direction to be defined.
- NV graphics data

**NOTE**

For details on NV graphics, see ["NV Graphics Memory" on page 31](#).

Follow the steps below.

- 1 After running a self test, hold down the Feed button for at least one second, and then select the Mode selection.**  
The Mode selection guidance is printed, and the power LED flashes.
- 2 After briefly (less than one second) pressing the Feed button once, and then hold it down for at least one second, to print the NV graphics information.**  
After information printing, the Mode selection guidance is printed again.
- 3 To finish, turn off the power, or select "Exit and Reboot Printer".**

## Software Setting Mode

Set the printer's memory switches and customized values.

See "[Software Settings](#)" on page 59 for information about available functions and settings and how to set them.

### NOTE

You can also make the software settings using the ESC/POS commands.

Follow the steps below.

- 1 After running a self test, hold down the Feed button for at least one second to enter the Mode selection.**  
The Mode selection guidance is printed, and the power LED flashes.
- 2 Briefly press the Feed button three times (less than one second), and then hold it down for at least one second to enter the Software settings mode (Customized value setting).**  
The Software setting mode guidance is printed, and the power LED flashes.

### Customize Value Settings

#### Modes

- 0: Exit
- 1: Print Current Settings
- 2: Print Density
- 3: Print Speed
- 4: Automatic Paper Reduction
- 5: Auto Paper Feed&Cut at cover close
- 8: Character/Font Settings
- 9: Interface Selection
- 10: Interface Settings
- 12: Command Execution (Offline)
- 14: Other Settings

Select items by executing following procedure.

- step 1. Press the Feed button less than 1 second as many times as the selected mode number.
- step 2. Press Feed button for 1 second or more.

**3 After briefly pressing the Feed button (less than one second) for the number of times shown in the print result, hold down the button for more than one second to select the setting items.**

The setting selected as the setting item, the current settings and initial settings are printed.

Depending on the setting item, you may need to continue selecting the setting item before the settings are printed.

For details on setting items, see "[Software Settings](#)" on page 59.

**4 Select a setting by briefly pressing the Feed button (less than one second) for the number of times applicable to the setting, and then hold down the button for more than one second to confirm your selection.**

After saving the settings, the Software setting mode guidance is printed, and the power LED flashes.

**5 To close Software setting mode, turn off the printer, or select "Exit" to return to Mode selection guidance, and then select "Exit and Reboot Printer".**

**NOTE**

- To select 0 as the item number, hold down the Feed button until printing starts.
- If the button is pressed a number of times that is not displayed by the Setup guidance, the operation is invalid and the same guidance is printed.

## Restore Default Values Mode

In Restore default values mode, following values saved on NV Memory will be set back to initial settings. When any error occurs, you can use to specify the reason.

Setting Item	Restore default settings	Restore default settings and Delete definition data
Customized Value	✓	✓
Memory switch	✓	✓
USB Interface Settings	✓	✓
Network settings	✓	✓
NV graphics	-	✓
NV bit image	-	✓
User defined page	-	✓
User NV memory	-	✓

Follow the steps below.

- 1 After running a self test, hold down the Feed button for at least one second to enter the Mode selection.**  
 The Mode selection guidance is printed, and the power LED flashes.
- 2 Briefly press the Feed button four times (less than one second), and then hold it down for at least one second to enter the Restore Default Values.**  
 The guidance is printed.
- 3 Briefly press the Feed button once (less than one second), hold it down for at least one second. (Hold down the Feed button until the message of restore completion is printed.)**

## Interface Setup Mode

Use this mode to setup the interface and other settings.

Follow the steps below.

- 1 After running a self test, hold down the Feed button for at least one second to enter the Mode selection.**  
The Mode selection guidance is printed, and the power LED flashes.
- 2 Briefly press the Feed button five times (less than one second), and then hold it down for at least one second to enter the Interface Setup mode.**  
The guidance is printed.
- 3 After briefly pressing the Feed button (less than one second) for the number of times shown in the print result, hold down the button for more than one second to select the setting items.**

---

### Initialize

Select [Wi-Fi Setup] or [Bluetooth Setup] and select [Initialize] to restore the communication settings to the factory default. The printer is reset and restarted.

---

### SimpleAP mode (Wi-Fi model)

Select [Wi-Fi Setup] and select [SimpleAP] to start in SimpleAP mode. The printer is reset and restarted, and it begins printing the "SimpleAP Start" information.

Select this to quickly set up a network connection.

**NOTE**

For information on the Quick connection function, see "[Wi-Fi Interface \(Wi-Fi model\)](#)" on page 49.

---

### Auto re-connect to iOS device (Bluetooth model)

Select [Bluetooth Setup] and then select [Auto Re-Connect iOS], you can select whether to enable or disable auto reconnection to iOS devices.

**NOTE**

- For details on the auto re-connect function, see "[Auto Reconnect Feature](#)" on page 113.
- You can change the settings with TM-P80II Utility and Epson TM Utility.

## Bluetooth Security Settings (Bluetooth model)

Select [Bluetooth Setup], and then select [Security], and you can change the Bluetooth security settings.

### CAUTION

- If you change the security settings, the link key (pairing information) will be deleted. If the printer is already paired with a terminal, unpair them and then pair again.
- When the security level is set to "Low", pairing is always possible, which increases the possibility of unauthorized use by a third party. Change the setting at your own discretion and responsibility with full understanding of the risk.
- Bluetooth LE always enables searching regardless of the security setting.
- If you connect without pairing with Bluetooth LE, communication is not encrypted.
- To communicate via Bluetooth LE, use the development kit (Epson ePOS SDK for iOS) that supports the dedicated profile.

### NOTE

You can change the settings with TM-P80II Utility and Epson TM Utility.

## Bluetooth Classic

Security	Pairing Mode	Pairing Method
Low	Pairing is always possible	Just Works
Middle (initial setting)	Pairing is possible for one minute after printing the status sheet	Just Works
High	Pairing is possible for one minute after printing the status sheet	Numeric Comparison/Passkey Entry

## Bluetooth LE

Security	Pairing Mode	Pairing Method
Low	Always searchable (no pairing required to connect)	-
Middle (initial setting)	Always searchable (no pairing required to connect)	-
High	Always searchable Pairing is possible for one minute after printing the status sheet	Passkey Entry

## Pairing method when the security is set to Middle/High (from the printer)

When the security is set to Middle/High and the printer is ready to be paired, perform the following procedure.

### 1 Load paper in the printer, and then turn it on.

#### CAUTION

- Make sure no errors have occurred and that the printer is not off-line.
- You cannot pair the printer while the network is starting up immediately after the power is turned on.

### 2 Open the roll paper cover, hold down the FEED button (two seconds), and then close the roll paper cover.

A guidance that starts with "Next Action" will be printed.

### 3 Briefly press the Feed button (less than one second), and then hold down the button for at least one second.

### 4 A status sheet is printed, and the Bluetooth LED flashes a pattern indicating that pairing is now possible.

After this, the printer will be able to be paired for one minute only.

#### NOTE

You can enable pairing also by printing the status sheet by pressing the status sheet button.

## Pairing method when the security is set to High (from the host)

When the security is set to High and the printer is ready to be paired, perform the following procedure.

### 1 Search for the printer on the Bluetooth settings screen on the host device.

### 2 Select the printer you want to pair with.

The printer prints the Passkey.

### 3 Check that the printed Passkey and the Passkey displayed on the host device match, and then select "Pairing" on the host device.

## Bluetooth communication interval during power saving mode (Bluetooth model)

Select [Bluetooth Setup] and then [Low Power Level] to change the communication interval when waiting to receive data from the host in power saving mode.

- Level 1 (Standard) (initial setting)
- Level 2 (Short)



By changing the setting to [Level 2 (Short)], you can shorten the time until printing begins. However, since the frequency of communication increases, the power consumption of the printer and host will increase. Also, depending on the host, this setting may not be enabled and the host-specified communication interval may be used.

## Radio field intensity check mode (Wi-Fi model)

Information on the strength of the wireless LAN radio field is printed.

Follow the steps below.

- 1 After running a self test, hold down the Feed button for at least one second, and then select the Mode selection.**

Prints the Mode selection guidance, and the Power LED flashes.

- 2 After briefly (less than one second) pressing the Feed button for eight times, hold it down for at least one second to select the Radio field intensity check.**

The operation guidance is printed, and the Power LED flashes.

```

Radio Field Intensity Check

To start radio field intensity check :
  Press the FEED button 1 second or more.

To end mode :
  Press the POWER button 2 second or more.

```

- 3 Press the Feed button (approximately one second) until the buzzer sounds once.**

Continue this operation when repeating the Radio field intensity check.

```

SSID:xxxxxxx

AP 1
MAC Address   XX-XX-XX-XX-XX-XX
Channel       9
Encryption Type WPA2-PSK
Signal Level   High(-21dbm)

```

Print image for radio field intensity information

- 4 Turn the power off to finish.**

## Hexadecimal Dumping Mode

In hexadecimal dumping mode, data from the host device is printed in hexadecimal numbers and characters. By comparing the print outs and the program, you can check whether or not data is being sent to the printer correctly.

### NOTE

- When there are no characters that correspond to the print data, "." is printed.
- If you press the Feed button when there is less than one line of print data, one line is printed.
- During hexadecimal dumping mode, applications that check the printer status may not operate correctly. The printer only returns the status for the "Real-time transmission status" command.

Follow the steps below. Entering the hexadecimal dumping mode is also possible using the ESC/POS commands.

- 1 Open the roll paper cover.**
- 2 While pressing the Feed button, turn on the printer. (Hold down the Feed button until the Error LED turns on.)**
- 3 Close the roll paper cover.**

From this point, all data received by the printer is printed in the corresponding hexadecimal numbers and ASCII characters.

### Example of printing in hexadecimal dumping mode:

```
Hexadecimal Dump
To terminate hexadecimal dump,
press FEED button three times.

1B 21 00 1B 26 02 40 40 1B 69 . ! . . & . @ . i
1B 25 01 1B 63 34 00 1B 30 31 . % . . c 4 . . 0 1
41 42 43 44 45 46 47 48 49 4A A B C D E F G H I J

*** completed ***
```

- 4 To close hexadecimal dumping mode, turn off the printer after printing is complete, or press the Feed button for three times.**

## Printing a Status Sheet

Follow the steps below to check the interface settings.

**NOTE**

You cannot print after turning on the power while the Power LED is flashing.

- 1** Check that the printer is on.
- 2** Open the roll paper cover.
- 3** Install the roll paper.
- 4** Press and hold the Feed button for about 1 second until the buzzer sounds.
- 5** Close the roll paper cover.  
A guidance that starts with "Next Action" will be printed.
- 6** Press the Feed button briefly (less than one second) the number of times equal to the number indicated to the left of the status sheet you want to print, then hold down the button for at least one second.

Printing of a status sheet will start. The printer will return to normal mode after printing is finished.

**NOTE**

- After the status sheet is printed, only the print settings of the mainly connected interface are retained. For the mainly connected interface, see ["Printing Using Multiple Interfaces" on page 33](#).
- Wi-Fi status sheet is not printed while the printing communication protocol is being established. It will be printed after the connection is cut off (including being cut due to a time out).
- The Bluetooth status sheet is not printed if status sheet printing is performed under the following conditions.
  - \* Bluetooth is connected when the Bluetooth security is set to "Middle" or "High"
  - \* An error occurs when the Bluetooth security is set to "Middle" or "High"
  - \* Time between when a pairing request is received and Paskey printing starts when the Bluetooth security is set to "High"

HHH Network Status Sheet HHH



```

<General Info>
MAC Address      XX:XX:XX:XX:XX:XX
Wi-Fi Direct MAC XX:XX:XX:XX:XX:XX
Firmware         XX.XX.XXXXXX
                 (XXXXXXXXXXXXXX)
Printer Model    TM-P80II
Device Name      XXXXXXXX

<Wireless>
Wireless         Off
Comm Mode        None
Operation Mode   None
Comm Speed       None
SSID             None
Channel          None
:
:

<Wi-Fi Direct>
Simple AP        On
Operation Mode   IEEE802.11g/n
SSID            XXXXXXXX
Password        X
:
:

<TCP/IP IPv4>
IPv4             Enable
Obtain IP Address Unknown
IP Address       None
Subnet Mask      None
Default Gateway  None
APIPA           Disable
:
:

<TCP/IP IPv6>
IPv6             Disable

<Dynamic DNS>
Dynamic DNS      Disable
Host Name        XXXXXXXX
Obtain Host Name Auto

<Bonjour>
Bonjour          Enable
Wide-Area Bonjour Disable
Bonjour Name     XXXXXXXX
Service Name     EPSON TM-P80II

<SLP>
SLP              Enable

<LLMNR>
LLMNR           Enable
Host Name        None

<Idle Timeout>
LPR              90[sec]
Port9100         90[sec]
RAW (Custom Port) 90[sec]
:
:

```

\*\*\* Bluetooth Interface \*\*\*

```

Bluetooth Status
BD_ADDR : XX:XX:XX:XX:XX:XX
Device Name: XXXXXX
Module Ver : 1.11
Module Info: XXXXXX
Mode : Auto re-connect enable
Security : Middle

Bluetooth
BT:XXXXXXXXXXXX
DN:TM-P80II

```



# Web Config

Web Config is a printer's built-in web page that allows you to check and change printer settings on your browser.

To use Web Config, you need to set your computer's IP address to the same segment as the printer.

## How to Start Web Config

- 1 Start your web browser on a computer or smart device on the network and enter the IP address of the printer in the address field.

Example for HTTPS	Example for HTTP
IPv4: https://192.0.2.111/ IPv6: https://[2001:db8::1000:1]/	IPv4: http://192.0.2.111/ IPv6: http://[2001:db8::1000:1]/

- 2 Select [Advanced Settings].

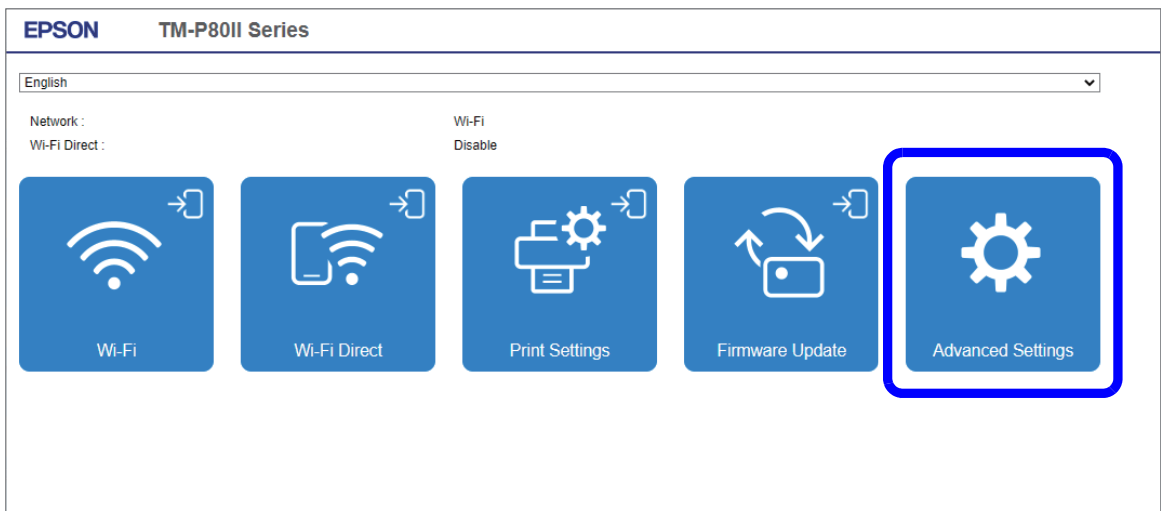

### 3 Select [Administrator Login].

The screenshot shows the EPSON TM-P80II Series web interface. At the top right, there is a button labeled "Administrator Login" which is highlighted with a blue rectangular box. The interface includes a "Status" tab and a "Network Security" tab. Under the "Status" tab, there are links for "Product Status" and "Network Status". The main content area is titled "Product Status" and contains several sections: a language dropdown menu set to "English", a "Printer Status" section showing "Available.", a table of system information (Firmware, Root Certificate Version, Network MAC Address), a "Date and Time" section, and an "Administrator Name/Contact Information" section. At the bottom, there is a "Refresh" button and a link to "Software Licenses".

### 4 When the authentication screen appears, enter your password and log in.

The default password is the serial number of the printer. You can find the serial number by running the self-test or on the nameplate attached to the printer.

#### NOTE

Enable JavaScript in your browser. Because a self-signed certificate owned by the printer is used when accessing HTTPS, a warning will appear in the browser when Web Config is started.

## What can be Configured in Web Config

For information on what can be configured in Web Config, refer to the Web Config Reference Guide. The Web Config Reference Guide can be obtained from the URL listed in ["Download"](#) on page 91.

# Application Development Information

This chapter describes how to control the printer and gives information useful for printer application development.

## Controlling the Printer

The printer supports the following command systems:

- ePOS-Print XML
- ESC/POS

Users can control the printer by using the aforementioned commands, or the following development kits or drivers.

- Epson ePOS SDK
- OPOS ADK
- OPOS ADK for .NET
- JavaPOS ADK
- EPSON Advanced Printer Driver (APD)
- EPSON TM Virtual Port Driver
- Epson TM/BA Series Thermal Printer Driver

### ePOS-Print XML

ePOS-Print XML is the Epson original control command system for POS printers defined in XML. With ePOS-Print XML commands, you can print in environments where HTTP communication is available and from OS applications. For detailed information about ePOS-Print XML, see the ePOS-Print XML User's Manual.

### ESC/POS

ESC/POS is the Epson original printer command system for POS printers and customer display. With ESC/POS commands, you can directly control all the printer functions, but detailed knowledge of printer specifications or combination of commands is required, compared to using drivers and applications.

For detailed information about ESC/POS commands, see the ESC/POS Command Reference that can be accessed from the following URL.

 <https://www.epson-biz.com/pos/reference/>



# Software

The following software is provided for application development.

## Development Kit

Software	Description
Epson ePOS SDK	This is a development kit for controlling TM printers from native applications of smart devices or web applications. This includes libraries, manuals, and sample programs.
for Android	
for iOS	
for JavaScript	
EPSON OPOS ADK	This OCX driver can control POS peripherals using OLE technology.* Because controlling POS peripherals with original commands is not required on the application side, efficient system development is possible.
EPSON OPOS ADK for .NET	The OPOS ADK for .NET is a POS industry standard printer driver compatible with Microsoft POS for .NET. It allows you to develop applications that are compatible with the UPOS (Unified POS) specification. When developing applications, use a separate development environment such as Microsoft Visual Studio .NET.
EPSON JavaPOS ADK	JavaPOS is the standard specification which defines an architecture and device interface (API) to access various POS devices from a Java based system. Using JavaPOS standard API allows control with Java based applications of functions inherent to each device. A flexible design with Java language and JavaPOS enables many different types of computer systems, such as stand alone or network configuration, to use a same application. You can use JavaPOS to build applications and drivers independently of platforms. This allows flexible configurations using thin clients to meet the system requirements.
Epson TM Print Assistant	A native application that relays print data between an application and the TM printer. Epson TM Print Assistant allows you to develop a system that enables printing from a Web application or a URL-scheme capable application such as FileMaker, on a smart device connected to the TM printer.
for Android	
for iOS	

\*: OLE technology developed by Microsoft divides software into part blocks. The OPOS driver is presupposed to be used with a development environment, such as Visual Basic, unlike ordinary Windows printer drivers. It is not a driver to be used for printing from commercial applications.

You can acquire documents regarding the UnifiedPOS from the following link.

<https://www.omg.org/spec/UPOS>

## Drivers

Software	Description	Operating environment
EPSON Advanced Printer Driver (APD)	In addition to ordinary Windows printer driver functions, this driver has controls specific to POS. The Status API (Epson original DLL) that monitors printer status and sends ESC/POS commands is also attached to this driver.	Windows
EPSON TM Virtual Port Driver	This is a serial/parallel-USB/LAN conversion driver to make an Epson TM/BA/EU printer connected via USB or LAN accessible from a POS application through a virtual serial or parallel port. It allows you to directly control devices connected via USB or LAN with ESC/POS commands without making changes in the POS application that controls devices connected via a serial or parallel interface.	Windows
Epson TM/BA Series Thermal Printer Driver	This driver allows you to control the printer using Common UNIX Printing System (CUPS) on GNU/Linux.  This is a full raster printer driver. It is able to print images, text, and vector graphics etc., that an application displays. With this driver many printer control are possible, such as paper cut timing control, cash drawer control, printing speed control, blank line skip, and upside-down printing.	GNU/Linux

## Utilities

Software	Description	Operating environment
Epson TM Utility	A utility that is available on the App Store or Google Play. Use this to perform wireless connection setup and change settings on the printer from iOS and Android devices. In addition, the utility has the following functions. <ul style="list-style-type: none"> <li>• Sample receipt printing</li> <li>• Printer status display</li> <li>• Quick pairing by NFC/QR code</li> <li>• Firmware update</li> </ul>	iOS, Android
TM-P80II Utility	A utility for checking and changing various printer settings. Use this utility to: <ul style="list-style-type: none"> <li>• Check the current settings</li> <li>• Test operation</li> <li>• Store logos</li> <li>• Set paper saving</li> <li>• Set printing control</li> <li>• Set communication interfaces</li> <li>• Configure the network settings</li> <li>• Save/restore settings</li> </ul>	Windows
TM Bluetooth Connector	Pairs the Bluetooth printer with your device, and sets the Bluetooth port to be used by the printer driver and/or an application. Using this software makes it easy to pair the printer because the software searches for and displays only Epson Bluetooth printers, and allows you to search the printer by its product name.	Windows

Deployment Tool	Use to make network and printer settings simultaneously. Allows you to make settings efficiently at the time of introducing TM printers for the first time, or when configuring multiple TM printers at the same time.	Windows
Monitoring Tool	Use to check a list of status for the Epson printers connected to the network. You can also update certificates for multiple printers used for WPA-Enterprise in a batch.	Windows
TM-P80II Firmware Updater	Use this tool to update the printer's firmware. An executable file and the firmware are packaged together.	Windows

## Others

Manual	Description
ePOS-Print XML User's Manual	Describes ePOS-Print XML statements. This manual comes with sample programs.
Web Config Reference Guide	Describes items that can be configured in Web Config.

## Download

You can obtain software and manuals from one of the following URLs.

For customers in North America, go to the following web site:

 <https://www.epson.com/support/>

For customers in other countries and regions, go to the following web site:

 <https://www.epson-biz.com/>

## Precautions when Developing Applications

This section describes information that you should be aware of when developing systems and applications using this product.

### Notes on Printing Barcodes and Two-Dimensional Symbols

- Ensure adequate space around the code; “quiet zone” that is required for the code.
- To print PDF417 (two-dimensional symbol), the following settings are recommended.
  - Module height: 3 to 5 times the module width
  - Vertical size of the symbol: approximately 5 mm {0.20"} or more
- The recognition rate of ladder bar codes and two-dimensional symbols may vary depending on widths of the modules, print density, environmental temperature, type of paper, and characteristics of the reader. Make sure to check the recognition rate beforehand to determine the settings and use conditions so that the restrictions of the reader are satisfied.
- Reading quality of multi-gradation bar codes and two-dimensional symbols is not guaranteed.
- When printing a ladder barcode or two-dimensional symbol that is created as a graphics data, set the print speed to level 5.

### Application Development and Distribution for iOS (Bluetooth model)

If your application uses Bluetooth to communicate with the printer, Epson must submit the application to Apple before you submit it to the App Store. Please apply for each application you want to submit to the App Store from the URL below.

 <https://www.epson-biz.com/ais/E/>

# Appendix

## Product Specifications

Printing method		Direct thermal line printing
Paper feeding method		Friction feed
Paper width		58 mm width model: 58 mm 80 mm width model: 80 mm
Roll paper loading method		Load roll paper by dropping it into the printer
Cutting method		Auto cutter <ul style="list-style-type: none"> <li>• 58 mm width model: cuts paper leaving one point on the right uncut</li> <li>• 80 mm width model: cuts paper leaving one point at the center</li> </ul>
Paper detector		Roll paper end detection (optical) Black mark detection
Cover detector		Roll paper cover open/close status detection (microswitch method)
Anti-Curl Function		Function to reduce curling of roll paper
Interface	USB-C	USB 2.0 compliant, Full-Speed (12 Mbps)
	Wi-Fi (Wi-Fi model)	IEEE802.11a/b/g/n/ac
	Bluetooth (Bluetooth model)	Bluetooth 5.0 Dual mode: Outside Brazil Bluetooth Dual mode: Brazil
Buffer	Receive buffer	4 KB (except Bluetooth communication), 64 KB (for Bluetooth communication)
	Downloaded buffer (user-defined characters and images)	12 KB
	NV graphics memory	384 KB
Barcode/Two-dimensional symbol printing		UPC-A, UPC-E, JAN8 / EAN8, JAN13 / EAN13, Code39, Code93, Code128, ITF, CODABAR(NW-7), GS1-128, GS1 DataBar, PDF417, QR code, Maxi Code, Data Matrix, Aztec Code, Two-dimensional GS1 DataBar, Composite Symbology
Overall dimensions (W x D x H)		Approx. 105 x 153.4 x 66.9 mm {4.13 x 6.04 x 2.63 in.} Dimensions with belt clip removed.
Weight	Wi-Fi model	58 mm width model: Approx. 520 g {1.15 lb} 80 mm width model: Approx. 511 g {1.13 lb} * Excluding the belt clip and paper.
	Bluetooth model	58 mm width model: Approx. 513 g {1.13 lb} 80 mm width model: Approx. 504 g {1.11 lb} * Excluding the belt clip and paper.

## Printing Specifications

			58 mm width model	80 mm width model
Printing method			Thermal line printing	
Dot density			203 × 203 dpi	
Paper feeding method			Friction feed	
Printing width	48 column mode (Standard column mode)		48.0 ± 0.2 mm {1.89 ± 0.01 in.}, 384 dots	72.0 ± 0.2 mm {2.83 ± 0.01 in.}, 576 dots
	42 column mode		48.0 ± 0.2 mm {1.89 ± 0.01 in.}, 384 dots	68.3 ± 0.2 mm {2.69 ± 0.01 in.}, 546 dots
Characters per line	48 column mode (Standard column mode)	Font A <sup>*1</sup>	32	48
		Font B	42	64
		Kanji Font A <sup>*1</sup>	Japanese: 16 Simplified Chinese: 16 Traditional Chinese: 16 Korean: 16	Japanese: 24 Simplified Chinese: 24 Traditional Chinese: 24 Korean: 24
		Kanji Font B	Japanese: 19 Korean: 24	Japanese: 28 Korean: 36
		Kanji Font C	Japanese: 24	Japanese: 36
	42 column mode	Font A <sup>*1</sup>	29	42
		Font B	42	60
		Kanji Font A <sup>*1</sup>	Japanese: 14 Simplified Chinese: 14 Traditional Chinese: 14 Korean: 14	Japanese: 21 Simplified Chinese: 21 Traditional Chinese: 21 Korean: 21
		Kanji Font B <sup>*1</sup>	Japanese: 19 Korean: 24	Japanese: 27 Korean: 34
		Kanji Font C	Japanese: 24	Japanese: 34
Line spacing			3.75 mm {1/5 in.} (Initial setting. Programmable by command)	
Maximum print speed <sup>*2</sup>			65 mm/s {2.56 in./s} (when using the anti-curl function) 100 mm/s {3.94 in./s} (when not using the anti-curl function) 40 mm/s {1.57 in./s} (Fine mode) <sup>*3</sup>	

dpi: dots per inch

\*1: Default setting

\*2: When a new battery is used, the battery is fully charged, the room temperature is 25°C, and the print density is 100%.

\*3: In the Fine mode, this maximum print speed is achieved regardless of whether the anti-curl function is used or not.

**CAUTION**

- The print speeds are measured under the following conditions: use of a new fully charged battery, room temperature, and 100% print density. In addition, the speed changes automatically depending on the voltage applied to the printer and head temperature.
- If the data transmission speed is slower than the maximum print speed, the print speed may fluctuate and the print result may become shaded and/or dot displacement in paper feeding may occur. Furthermore, if the data transmission speed is much slower than the maximum print speed (for example, when using Bluetooth LE), intermittent printing will occur.

## Character Specifications

Character set	ANK	95 alphanumeric characters	
		128 extended graphics characters x 54 pages (Includes user-defined pages. Models for South Asia do not support user-defined pages.)	
		18 international character sets (For South Asia: 29 sets)	
	Japanese	6,879 characters of JIS X0208-1990, 845 special characters	
		11,233 characters of JIS X0213:2004, One special character	
	Simplified Chinese	28,553 characters of GB18030-2000	
	Traditional Chinese	13,502 characters of Big5	
Korean	8,224 characters of KSC5601		
Character code	Japanese	ISO-2022-JP / Shift_JIS / Shift_JIS-2004	
	Simplified Chinese	GB18030-2000	
	Traditional Chinese	Big5	
	Korean	KSC5601	
	Unicode*1	UTF-8	
The number of dots per character (W x H)	48 column mode (Standard column mode)	Font A	12 × 24 (includes 2-dot horizontal spacing)
		Font B	9 × 17 (includes 2-dot horizontal spacing)
		Special Font A	12 × 24 (includes 2-dot horizontal spacing)
		Special Font B	9 × 24 (includes 2-dot horizontal spacing)
		Hindi Font A	Proportional x 32
		Hindi Font B	Proportional x 24
		Kanji Font A	Japanese: 24 × 24 Simplified Chinese: 24 × 24 Traditional Chinese: 24 × 24 Korean: 24 × 24
		Kanji Font B	Japanese: 20 × 24 Korean: 16 × 16
Kanji Font C	Japanese: 16 × 16		



42 column mode	Font A	13 × 24 (includes 3-dot horizontal spacing)
	Font B	9 × 17 (includes 2-dot horizontal spacing)
	Special Font A	12 × 24 (includes 2-dot horizontal spacing)
	Special Font B	9 × 24 (includes 2-dot horizontal spacing)
	Hindi Font A	Proportional x 32
	Hindi Font B	Proportional x 24
	Kanji Font A	Japanese: 26× 24 Simplified Chinese: 26× 24 Traditional Chinese: 26× 24 Korean: 26× 24 (includes 2-dot horizontal spacing)
	Kanji Font B	Japanese: 20 × 24 Korean: 16 × 16
	Kanji Font C	Japanese: 16× 16
Character size <sup>*2</sup> (W × H)	Font A	1.25 × 3.00 mm {0.05 × 0.12 in.}
	Font B	0.88×2.13 mm {0.03×0.08 in.}
	Special Font A	1.25 × 3.0 mm {0.05 × 0.12 in.}
	Special Font B	0.88 × 3.0 mm {0.03 × 0.12 in.}
	Hindi Font A	Proportional x 4.00 mm {0.16 in.}
	Hindi Font B	Proportional x 3.00 mm {0.12 in.}
	Kanji Font A	Japanese: 3.00 × 3.00 mm {0.12 × 0.12 in.} Simplified Chinese: 3.00 × 3.00 mm {0.12 × 0.12 in.} Traditional Chinese: 3.00 × 3.00 mm {0.12 × 0.12 in.} Korean: 3.00 × 3.00 mm {0.12 × 0.12 in.}
	Kanji Font B	Japanese: 2.50 x 3.00 mm {0.10 x 0.12 in.} Korean: 2.00 × 2.00 mm {0.08 x 0.08 in.}
	Kanji Font C	Japanese: 2.00 × 2.00 mm {0.08 × 0.08 in.}

Special fonts= Thai fonts

1: Only the character sets installed on the printer can be printed.

2: Space between characters is not included. Characters can be scaled up to 64 times as large as the standard size. Character size is the same in both 48 column mode and 42 column mode.

**NOTE**

By specifying UTF-8 character encoding, all the installed character sets can be printed. For more details on printing Unicode characters, see "FS ( C" of the ESC/POS command reference, or manual of the software you use. ("[Application Development Information](#)" on page 88)

## Paper Specifications

		58 mm width model	80 mm width model
Paper type		Thermal paper <ul style="list-style-type: none"> <li>• Receipt paper (without black mark)</li> <li>• Receipt paper (with black mark)</li> </ul>	
Form		Roll paper	
Size	Width	57.5 ± 0.5 mm {2.26 ± 0.02 in.}	79.5 ± 0.5 mm {3.13 × 0.02 in.}
	Roll width when taken up	58 ± 0.5 mm {2.28 ± 0.02 in.}	80 ± 0.5 mm {3.15 × 0.02 in.}
	Roll outside diameter	51 mm {2.01 in.} maximum	
	Roll core outside diameter	At least 18 mm {0.71 in.}	
	Roll core inside diameter	At least 12 mm {0.47 in.}	
	Roll core width	Must be the same as the paper width or smaller than the paper width with a difference of 1 mm {0.04 in.} or less.	
	Paper thickness	75 µm at maximum, 50 µm at minimum	
Specified original paper		TF50KS-EY, TF60KS-E (NIPPON Paper Industries Co., Ltd.) PD160R, PD190R (OJI Paper Mfg. Co., Ltd.) P220AGB-1 (Mitsubishi Paper Mills Limited.) AP45KS-ND, AP50KS-ND (Jujo Thermal Oy) P5047(55), P5047(46) (Mitsubishi HiTec Paper Europe GmbH) KT55FA, KT48FA, KT55PF, KT48PF (Papierfabrik AugustKoehler SE)	

### CAUTION

- Paper must not be pasted to the roll paper core.
- Use of thermal paper with a pre-printed recording surface should be avoided. Using it can cause the thermal head to stick to the thermal paper surface during printing, and cause printing failure and other problems. The pre-printing also can result in reduced print density. When using thermal paper with a pre-printed recording surface, pre-printing should be done in accordance with the conditions (ink type, printing and other conditions) recommended by the paper manufacturer, and the thermal paper should be checked to ensure that there is no faulty printing, loss of print density, or other problems.

### NOTE

It is recommended to mark the end of the roll with a red line so that the end of the roll can be recognized.

## Recommended Print Density for Specified Base Paper

To ensure good print quality, it is recommended to set the print density (see "Software Settings" on page 59) according to the paper used.

Specified original paper	Print density
TF50KS-EY, TF60KS-E	100%
P220AGB-1	105%
PD160R, PD190R	110%
AP45KS-ND, AP50KS-ND, KT48FA, P5047(46), P5047(55)	120%
KT55FA, KT48PF, KT55PF	130%

### Requirements for black marks

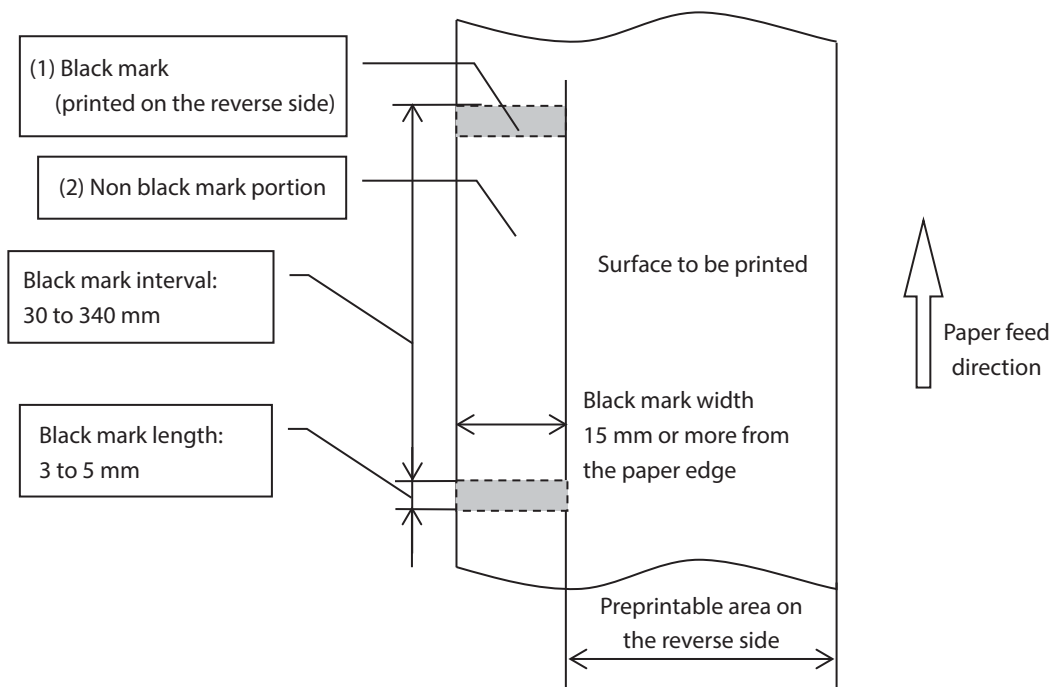

The allowable relation between the reflecting rate in the (1) black mark and the (2) non black mark portion must be as shown in the table below.

	Reflecting rate
(1) Black mark	16% or less
(2) Non black mark portion	85% or more

**NOTE**

The reflecting rate means the value which is measured with a Macbeth density meter (PCMII) D filter.

# Printing Area

## 80 mm width model

**CAUTION**

Printing is automatically performed in one to six-part energization depending on the printing conditions. During printing with two to six-part energization, a misalignment (horizontal ruled line shift) of 1/12 to 1/4 dot might occur in the paper feeding direction due to segmented printing.



### 48 column mode (without black marks)

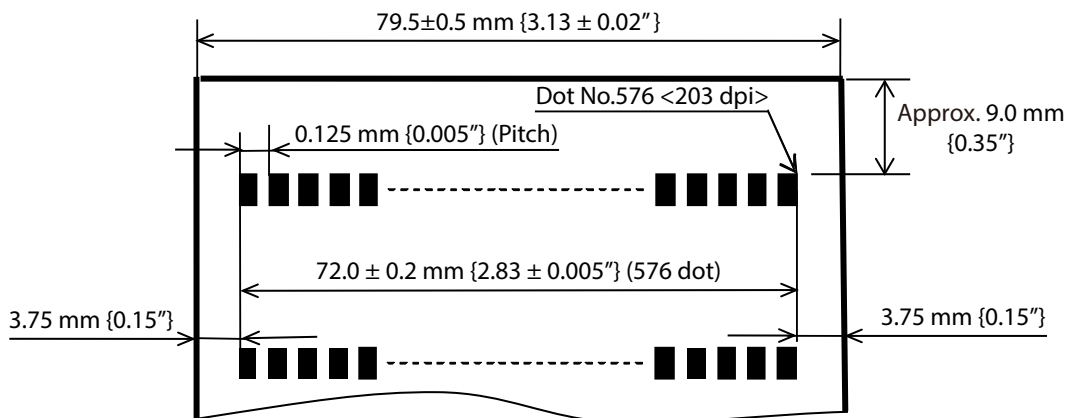

### 48 column mode (with black marks)

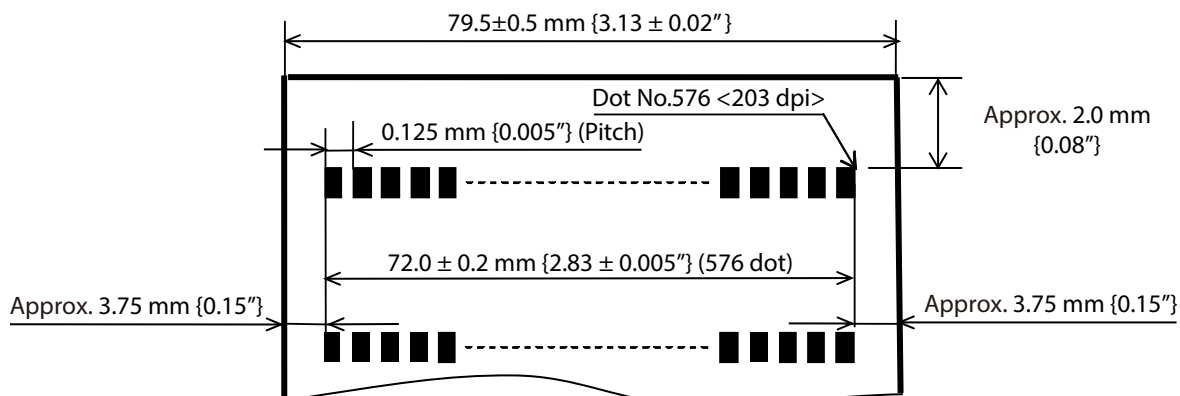

**CAUTION**

If you have set the paper layout setting to use paper with black marks, be sure to remove the paper after auto cut before sending the next command in order to prevent paper out or paper jam due to backward paper feeding.

### 42 column mode

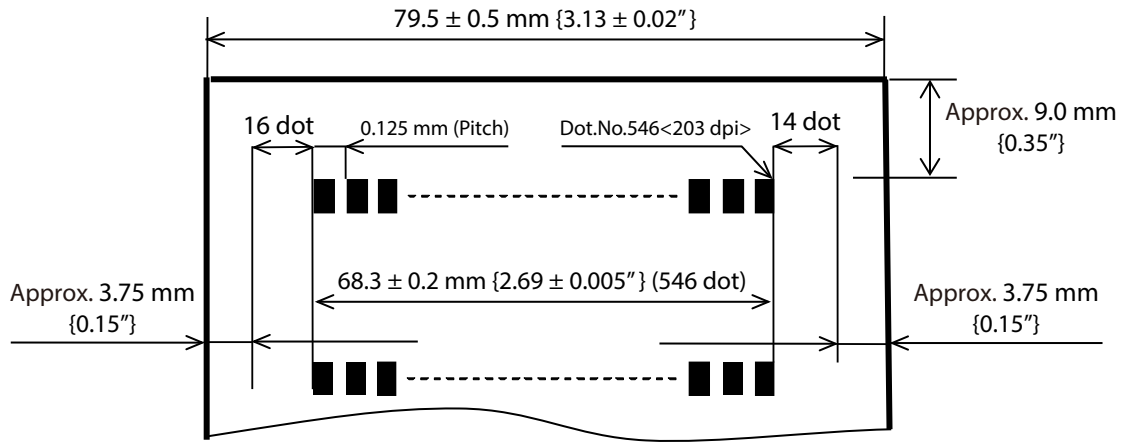

### 58 mm width model

**CAUTION**

Printing is automatically performed in one to six-part energization depending on the printing conditions. During printing with two to six-part energization, a misalignment (horizontal ruled line shift) of 1/12 to 1/4 dot might occur in the paper feeding direction due to segmented printing.

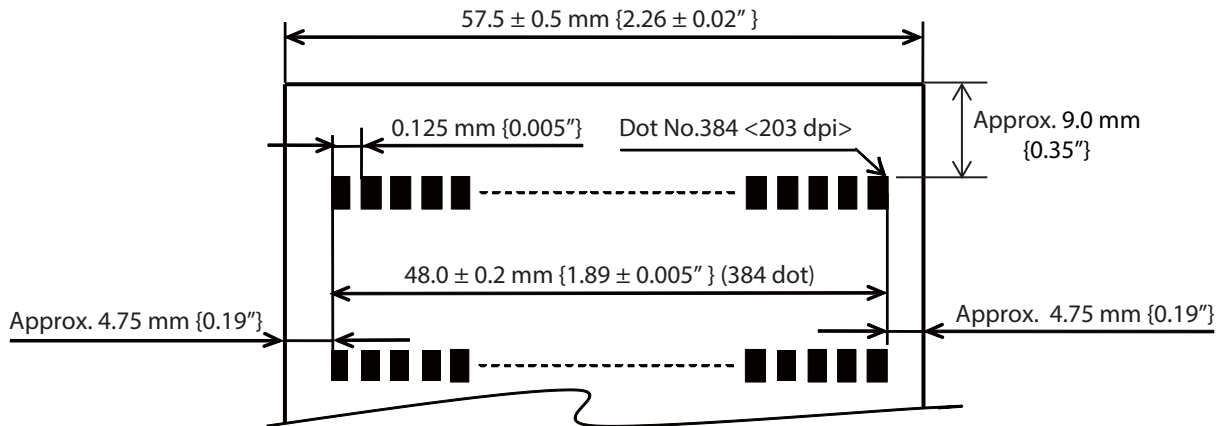

## Print Position and Auto Cut Position

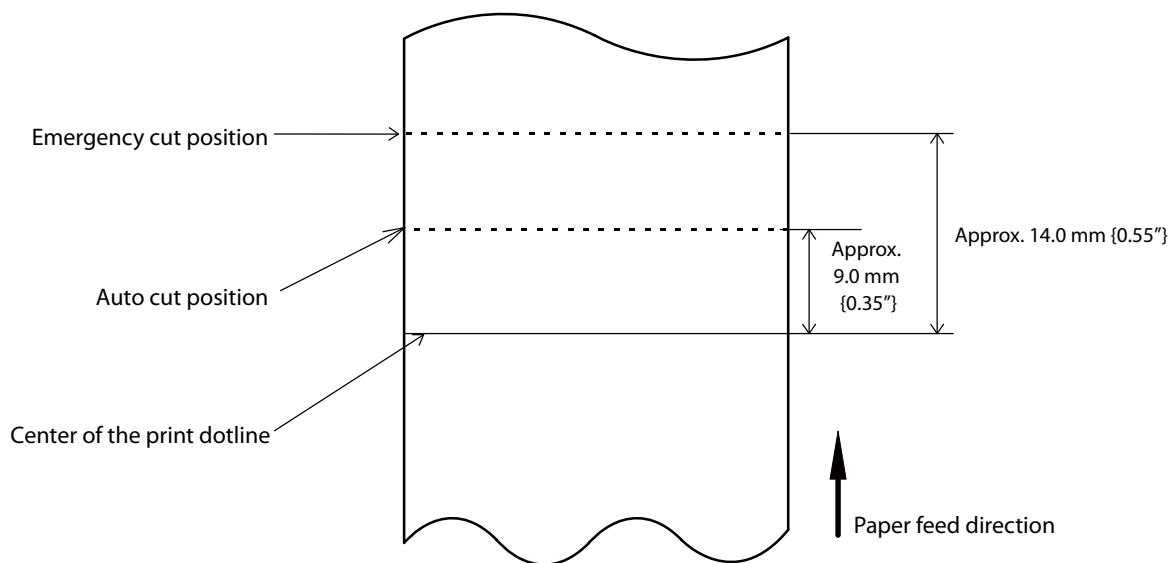
**CAUTION**

The values above may vary slightly as a result of paper slack or variations in the paper. Take this into account when setting the cutting position.

## Electrical Characteristics

Item		Specifications	
Dedicated battery (OT-BY80II)	Model: D241A	Rated voltage: 7.2 VDC Capacity: Typ. 1950 mAh, Min. 1850 mAh Approximate life span (number of charge/discharge cycles): 500 cycles	
USB charging		<p>Note:</p> <p>Epson cannot guarantee and is not responsible for the performance or quality of 3rd party USB charging devices. The following is provided as a starting point reference to consider in selecting a 3rd party USB charging device.</p> <p>Be sure to use Product that meets the following electrical specifications:</p> <p>Minimum output 5.0 V/0.5 A Maximum output 5.0 V/8.0 A</p> <p>Be sure to use Product that meets appropriate and applicable safety certifications, ratings and regulation, which apply in the region where the product will be used.</p> <p>For examples,</p> <ul style="list-style-type: none"> <li>• FCC Part 15 compliant</li> <li>• UL/CSA/TUV/ISED/CE/PSE/BIS/CCC etc.</li> </ul> <p>When charging the printer, be sure to use the included USB Type-C cable.</p>	
Wireless Charging		3 to 6 hours (depending on the specifications of your wireless charger)	
Charging time <sup>*1</sup>	5 V/3 A	At normal temperatures: Approx. 2.5 hours	At low temperatures: Approx. 5 hours
	5 V/1.5 A	At normal temperatures: Approx. 4.5 hours	At low temperatures: Approx. 8.5 hours
	5 V/900 mA 5 V/500 mA	At normal temperatures: Approx. 15 hours	At low temperatures: Approx. 29.5 hours
Continuous operating time <sup>*2</sup>	Wi-Fi model	When the power save mode is enabled: Approx. 24 hours	When the power save mode is disabled: Approx. 13 hours
	Bluetooth model	Approx. 34 hours	

\*1: Charging time is the measured time from approximately 0% remaining charge to fully charged under the following conditions.

\*The battery is new.

\*The printer is powered off.

\*Normal temperatures are defined as approximately 10 to 30°C {50 to 86°F} and low temperatures as approximately 0 to 10°C {32 to 50°F}.

\*2: The test conditions are as follows.

\* The battery is new.

\* The battery is fully charged.

\* Printed pattern is ANK 48 digits (Font A), 20 lines + paper feed by 6 lines.

\* Printed once every five minutes.

\* Performed under normal temperature of 25°C.

\* Print density is 100%

\* Access point used is CISCO AIR-LAP1142N-P-K9

\* Wireless communication conditions: beacon interval is 200 ms, DTIM interval is 1, no broadcast

\* The time it takes for the battery to go from fully charged to approximately 0% (E level).

The power saving mode can be set in "Wi-Fi" - "Energy Saving" of the TM-P80II Utility or TM Utility.

**NOTE**

Note that the above continuous operating hours may vary depending on the operating environment and other factors.

## Reliability

Item		Specifications
Life* <sup>1</sup>	Printer mechanism	Capable of printing 10 million lines This is based on the assumption that the specified paper is used, that each line is 3.75 mm, and that the paper is fed for 26 lines and 20 lines are printed repeatedly. The total distance of paper passing through the print head is equivalent to about 50 km.
	Thermal head	50 km (when printed with recommended print density and print speed) (Reference: 100 million dots per heating element)
	Auto cutter	500,000 cuts* <sup>2</sup>
MTBF* <sup>3</sup>		120,000 hours
MCBF* <sup>4</sup>		16 million lines

\*1: Indicates the point at which the wear-out failure period starts.

\*2: Value when the specified paper is used.

\*3: Indicates the mean time between failures during the random failure period.

\*4: Indicates the overall mean time between failures, including wear-out and random failures, before the life is reached.

**NOTE**

Depending on the paper condition, paper dust may adhere to the head and platen.



# Environmental Conditions

Guaranteed printer operating environment	When operating on battery only	<p>Temperature: -15 to 50°C {5 to 122°F} (Print quality is not guaranteed)</p> <p>Humidity: 10 to 90% RH (excluding paper)</p> <p>Note:</p> <p>When printing in an environment of 0°C {32°F} or lower on a Wi-Fi model, the coverage should be 33% or lower.</p>
	When operating on battery and USB power adapter	<p>Temperature: -15 to 50°C {5 to 122°F} (Print quality is not guaranteed)</p> <p>Humidity: 10 to 90% RH (excluding paper)</p> <p>Note:</p> <ul style="list-style-type: none"> <li>The guaranteed temperature range for charging is shown in the "During charging" column below.</li> <li>When printing in an environment of 0°C {32°F} or lower on a Wi-Fi model, the coverage should be 33% or lower.</li> </ul>
Guaranteed environment for battery (OT-BY80II) operation	During discharge	<p>Temperature: -20 to 55°C {-4 to 131°F}</p> <p>Humidity: 10 to 90% RH</p> <p>* Battery performance is reduced at low temperatures.</p>
	During charging	<p>Temperature: 0 to 40°C {32 to 104°F}</p> <p>Humidity: 10 to 90% RH</p>
Print quality assurance environment	<p>Temperature: 5 to 45°C {41 to 113°F}</p> <p>Humidity: 10 to 90% RH</p> <p>Caution: No condensation</p> <p>Legend:</p> <ul style="list-style-type: none"> <li>Blue box: Range that guarantees print quality</li> <li>Light blue box +: Range that guarantees printer operation</li> </ul>	

Storage environment	There is no abnormality in operation after the printer was stored under the following conditions, and left at 25°C and 60% RH for two hours.	
	High temperature	Temperature: 70°C {158°F} Storage time: 120 hours
	Low temperature	Temperature: -25°C {-13°F} Storage time: 120 hours
	Hot and humid	Temperature: 50°C {122°F} Humidity: 90% RH Storage time: 120 hours
Vibration resistance	When packed	Frequency: 5 to 55 Hz Acceleration: Approx. 19.6 m/s <sup>2</sup> {2G} Sweep: 10 minutes (half cycle) Time: 1 hour Orientation: x, y, and z There is no external or internal visible damage and the unit operates normally after being subjected to vibration.
Shock resistance	When packed	Packing: Epson standard package specifications Height: 60 cm {23.62 in.} Orientation: 1 corner, 3 edges, and 6 surfaces There is no external or internal visible damage and the unit operates normally after being dropped.
	When unpacked	Height: 5 cm {1.97 in.} Orientation: Lift one edge and release it (for all 4 edges) There is no external or internal visible damage and the unit operates normally after being dropped while not operating.
Drop impact resistance*1	150 cm {59.06 in.}	
Acoustic noise	Operating	Approximately 55 dB (ANSI bystander position) Note: The above noise value is based on our evaluation conditions. Acoustic noise differs depending on the paper used, printing contents, and the setting values, such as print speed or print density.
Water and dust resistance*2	Vertical placement	IP54 compliant Note: Roll paper side is excluded. When roll paper recess is installed on the bottom side.
	Horizontal placement	IP54 compliant Note: Roll paper side is excluded. When the belt clip is installed on the bottom side.
Altitude	3,000 m or less	

\*1 The value is based on test results in accordance with JIS C60068-2-31:2013 (IEC 60068-2-31:2008).

\*2 This is the result of an evaluation conducted by a third party evaluation organization based on JISC0920 (IEC60529:2001), and does not guarantee conformance to the standard, no damage, or no failure.

**NOTE**

If the paper is left loaded for an extended period of time, the paper may become deformed and the printing may become lighter in some areas. Therefore, when printing after leaving the paper loaded for a long time, feed the paper about 30 mm before printing.

## External Dimensions

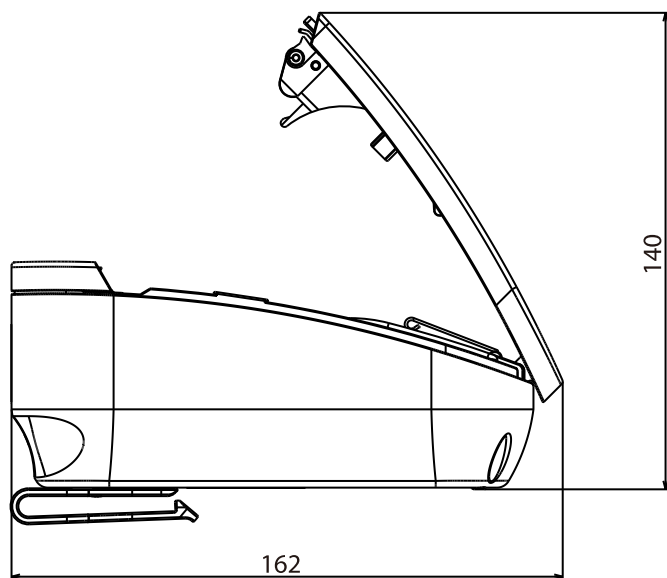
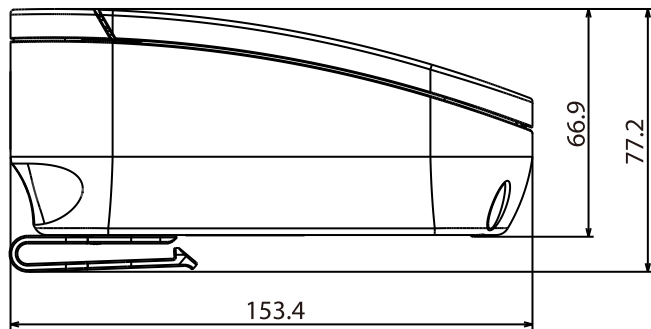
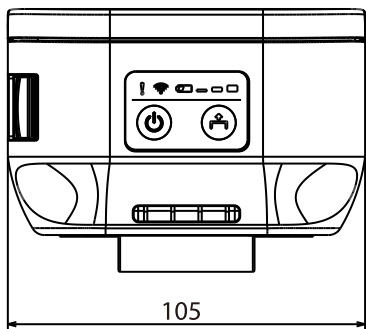
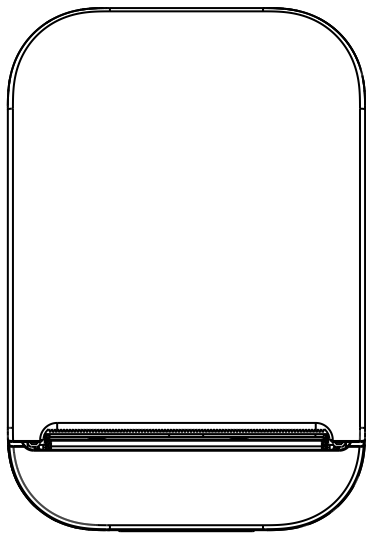

[Unit: mm]

# Specifications of Interface

## USB Interface

### USB interface connector

USB-C connector

### USB transmission specifications

#### USB function

Item		Specifications
Overall specifications		According to USB 2.0 specifications
Transmission speed		USB Full-Speed (12 Mbps)
Transmission method		USB bulk transmission method
Power supply specifications		USB self power supply function
Current consumed by USB bus		2 mA
USB packet size (with Full-Speed connection)	USB bulk OUT (TM)	64 bytes
	USB bulk IN (TM)	64 bytes
USB device class		Both USB vendor-defined class and USB printer class are supported.

**NOTE**

To set the USB device class, see ["Software Settings" on page 59](#).

### USB Descriptor

Item		USB vendor-defined class	USB printer class
Vendor ID		04B8h	
Product ID		0202h	0E35h
String Descriptor	Manufacturer	EPSON	
	Product	TM-P80II Wi-Fi TM-P80II Bluetooth	
	Serial number	Character string based on the product serial number	

## Network Interface (Wi-Fi model)

### Support protocols

Protocols	Usage	Port No.
IP, ARP, ICMP, UDP, TCP	Basic communication protocols	-
LP/LPR, TCP Socket Port	Printing protocols	515, 9100
HTTP/HTTPS	Used in Web Config	80/443
	Used in ePOS-Print	80/443/8008/8009/8043/8143
SNMP	Used in setting and monitoring	161
ENPC	Used in setting and monitoring	3289
DHCP, APIPA	Used in automatic setting for the IP address and so on	-

### Network parameters

Item	Initial settings
IP address acquisition	Automatic
APIPA	Disabled
Socket Timeout	90 seconds
SNMP IP Trap 1	Disabled
SNMP IP Trap 2	Disabled
Communication mode	Auto negotiation

### Printing communication protocol

- LP, LPR: Transfers printing data
- TCP Socket Port: Transfers printing data and printer status via bidirectional direct socket communication.

#### LP, LPR

- Max. simultaneous connections: 6
- Number of connections for which printing is available: 1 (occupied until the connection is released.)
- Time out: 90 seconds (changeable)
- Job cancel: Not available
- Banner printing: Not available

**Socket communication**

- Port type TCP communication port for direct printing
- Port number 9100
- Port communication direction bidirectional
- Max. simultaneous connections 6
- Number of connections for which printing is available 1 (occupied until the connection is released.)
- Time out: 90 seconds (changeable)

**Specification**

- IEEE802.11b/g/n (2.4 GHz band) or IEEE802.11a/b/g/n/ac (2.4 GHz or 5 GHz band) compliant Wi-Fi communication compatible.
- Support the IP address automatic acquisition function (DHCP, APIPA).
- Infrastructure mode is supported.

**Communication Standard\***

- IEEE802.11b (2.4 GHz)
- IEEE802.11g (2.4 GHz)
- IEEE802.11n (2.4 GHz)
- IEEE802.11a (5 GHz)
- IEEE802.11n (5 GHz)
- IEEE802.11ac (5 GHz)

\* The frequency bands that can be used vary depending on the model.

**Security**

Security can be selected from among the following:

- WPA-PSK(AES)
- WPA2-Personal
- WPA2/WPA3-Enterprise
- WPA3-SAE

**Initial settings**

These settings apply when the printer is initialized in the Interface Setup mode.

Parameter	Setting value
Communication standard	Auto
Network mode	Infrastructure mode
SSID	EpsonNet
Encryption type	None
Passphrase	None

\* You can connect to a WPA2-PSK (AES) access point using the settings above.

**Settings in SimpleAP mode (Factory default settings)**

Parameter	Setting value
SSID	DIRECT-TM-P80II-"serial number"
Passphrase	Serial number

\* In SimpleAP mode, DHCP Server is working and assign IP address to host automatically.

**Notes on use**

- When you initialize or change the printer settings, the printer is reset to reflect the settings. It may take about 1 minute depending on the network settings or environment. Also, your application may indicate power off during the time waiting for reset. In that case, wait for about 1 minute, and then reconnect to the printer.
- In areas where Wi-Fi communication is congested, your application may erroneously recognize that communication is disconnected and indicate power off due to response delay. Also, depending on the combination with the access point used, Wi-Fi communication performance may be degraded. Both of these issues may be improved by disabling the Wi-Fi power saving function (Power Save). However, since the power saving function is disabled, the printer will consume more power. The setting can be changed using Web Config or TM-P80II Utility.

## Bluetooth Interface (Bluetooth model)

### CAUTION

Countries where Bluetooth can be used are limited. Since notes are provided for each country, check the sheet supplied with the product.

### Specification

- Bluetooth 5.0 Dual mode: Outside Brazil  
Bluetooth Dual mode: Brazil
- Bluetooth Power Class 2
- Built-in antenna
- Device name setting is possible
- Pairing information of up to 8 devices can be registered
- The following features of Bluetooth LE are not supported.  
2 Msym/s PHY for LE (LE 2M PHY), LE Long Range (LE Coded), LE Advertising Extensions

### Initial Settings

Setting Contents	Setting Items	Initial Settings
Bluetooth communication settings	Bluetooth device name	Classic: "TM-P80II-xxxxxx" Bluetooth LE: "TM-P80II-xxxxxx-L" ("xxxxxx" is the last six digits of the printer serial number.)
	Bundle Seed ID	"TXAEAV5RN4"
	Enable/Disable auto reconnect to iOS device	"1" (Enable)
	Bluetooth Security	Middle
	Bluetooth communication interval during power saving mode	Level 1 (Standard)

### CAUTION

When the security level is set to "Low", pairing is always possible, which increases the possibility of unauthorized use by a third party. Change the setting at your own discretion and responsibility with full understanding of the risk.



## Auto Reconnect Feature

The auto reconnect feature allows the printer to automatically restore a connection in the following situations if the Bluetooth connection to the iOS device is lost.

- When the printer is turned on
- When the signal is dropped and then restored

The following shows the printer operations and connection methods when the auto reconnect feature is enabled or disabled.

Auto Reconnect Feature	Enabled	Disabled
Printer operations when Bluetooth is disconnected	Perform the following reconnection sequence. <b>[Reconnection sequence]</b> 1. The printer tries to connect to the iOS device to which it was last connected. 2. When step 1 fails, the printer waits for connections from other devices. 3. If connection is not established in step 2, the printer tries again to connect to the iOS device to which it last connected. Steps 1 and 2 are repeated until a connection is established.	Wait for a connection from the Bluetooth device.
Reconnecting to iOS device	Reconnect automatically.	Make settings on the Bluetooth settings screen on the iOS device.
Switch to connection from other device	Method 1: After disabling the Bluetooth feature of the connected iOS device, make connection settings on the Bluetooth device that you want to connect. (When the auto reconnect feature is enabled, it may take some time to connect.)	
	Method 2: After disconnecting from the connected iOS device using applications with the Epson TM Utility or Epson ePOS SDK disconnection feature, make settings on the Bluetooth device you want to connect.	

\* In the following situations, even if the feature is enabled, the same operations are performed as when it is disabled.

- When the last Bluetooth device connected was not an iOS device.
- When wireless communication settings are initialized from the printer.
- When the Bluetooth connection is cut from the "Printer Selection" screen of the Epson TM Utility.
- When the Bluetooth connection is cut using disconnectDevice API for Epson ePOS SDK for iOS.
- When the last connection was made using Bluetooth LE.

\* We recommend disabling this feature when using the printer from devices that are not running iOS.

\* When using a single printer between multiple iOS devices, disable this feature to prevent unintended reconnections via Bluetooth. Otherwise, if you cut the Bluetooth connection using disconnectDevice API on an iOS device that stopped using the printer, the connection will just be restored when the printer is restarted.

---

## Notes on use

### Time required until printing starts

- If the host computer and the printer are not connected on a continuous basis but rather connected every time the printer starts printing, some time may be needed for the printer to actually start printing after the host computer commands printing. This pause is the time required for processing the connection between the host computer and the printer.  
After opening the port, leave an interval of 300 msec or more before sending data to the port.
- After turning on the printer, wait until the initialization process is complete (about 40 seconds) before printing or making settings via Bluetooth.

### Timing to shut the connection off

Even if data transfer from the application on the host computer has already been completed, the data may remain in the printer's internal buffer. Since data remaining in the buffer may be discarded when the connection is disconnected, when disconnecting the wireless connection immediately after printing, use status or other means to confirm that the transmitted data has been printed reliably.

If a connection between the host computer and the printer is shut off while the printer is offline, it may not be re-established. In this case, first clear the printer offline causes, and then try to re-establish the connection.

---

## Notes when communicating with iOS devices

### Print data deletion and Bluetooth disconnections occur

#### Situation

Depending on the specifications of the iOS device, print data sent to the printer may be deleted. When this occurs, the Bluetooth connection between the printer and the iOS device is disconnected.

#### Conditions

This occurs when the printer is not ready to print, and 64 KB or more of print data is sent to the printer.

#### <Status in which the printer cannot print>

- When the roll paper cover is open
- When the paper is out

#### Solution

Do not send data to the printer if the printer is not ready to print.

For developers using the SDK from Epson, see the User's Manual - Chapter 3 Programming Guide - "Printing After Checking the Printer Status".

Since Bluetooth is disconnected when this occurs, if the auto reconnect feature is not enabled, you need to reconnect from the Bluetooth settings screen on the iOS device.

When using the SDK from Epson, this connection process is not necessary.

## The iOS application cannot receive the data sent from the printer

### Situation

Although the printer sends data to the iOS device and the data is received by the iOS device, depending on the combination of the iOS version and the iOS device, the iOS application may not be able to receive the data.

### Conditions

This may occur in combinations of the following conditions.

- iOS version: 7.1, 7.1.1
- iOS device: iPhone 5s, iPhone 5c, iPhone 5, iPad Air, iPad mini 3, iPad (4th generation), iPad mini, iPod touch (5th generation), iPhone 4s, iPhone 4, iPad (3rd generation), iPad 2
- Application processing: If the Bluetooth port is closed and then reopened while the application is running.

### Solution

The solution differs depending on the iOS device being used. See the following table.

iOS Device	Solution
iPhone 4s iPhone 4 iPad (3rd generation) iPad 2	This situation can be avoided by using the Epson ePOS SDK for iOS.

## NFC Tag

Transmission standard	ISO14443 A
Frequency	13.56 MHz
Memory	144 byte
Transmission distance	Approximately 10 mm from the NFC installation location.

### NOTE

- The transmission distance is an estimate that depends on our experiment conditions and is not a guaranteed value.
- It varies based on the installation environment and target device.

## Character Code Tables

Refer to the following URL regarding the character code table.

 <https://www.epson-biz.com/pos/reference/charcode/>